

### GENERAL DESCRIPTION

The SGM66055 is an internally compensated, 2.2MHz switching frequency, current mode, synchronous step-up switching regulator. Even below the minimum system battery voltage, the device maintains the output voltage regulation for a minimum output load current of 0.9A. This device turns into power-saving mode to maintain high efficiency by lowering switching frequency. With its anti-ringing circuitry damping the charge in parasitic capacitor, it reduces EMI interference significantly. Its output is disconnected by the rectifier circuit during shutdown, with no input to output leakage.

The SGM66055-4.5/5.4 are available in the Green WLCSP-1.21×1.21-9B package; the SGM66055-5.0 is available in the Green WLCSP-1.21×1.21-9B and TDFN-2×3-8BL packages. They operate over an ambient temperature range of -40°C to +85°C.

### FEATURES

- 93% Efficient Synchronous Boost Converter
- Device Quiescent Current: 23µA (TYP)
- Less than 1µA Shutdown Current
- Operating Input Voltage Range: 2.5V to 4.5V
- Fixed Output Voltages: 4.5V, 5.0V and 5.4V
- Output Voltage Clamping: 5.7V
- Power-Save Mode for Improved Efficiency at Low Output Power
- Load Disconnect During Shutdown
- Low Reverse Leakage Current when  $V_{OUT} > V_{IN}$
- Over-Temperature Protection
- Available in Green WLCSP-1.21×1.21-9B and TDFN-2×3-8BL Packages
- -40°C to +85°C Operating Temperature Range

### APPLICATIONS

Class-D Audio Amplifier and USB OTG Supply  
 Boost for Low-Voltage Li-Ion Batteries  
 Smart Phones, Tablets, Portable Devices, Wearables

### TYPICAL APPLICATION

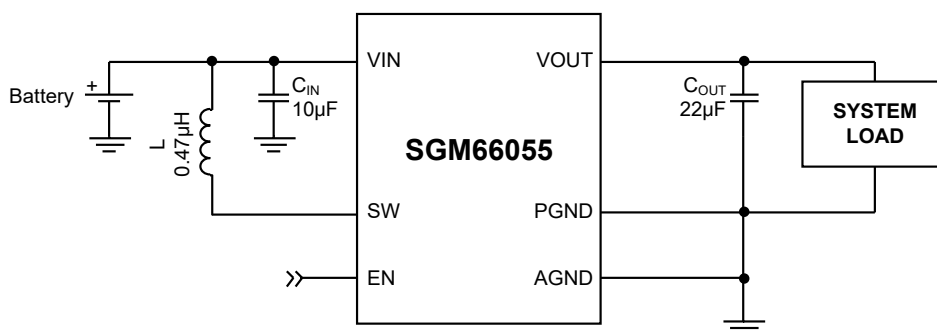

Figure 1. Typical Application Circuit

**PACKAGE/ORDERING INFORMATION**

MODEL	V <sub>OUT</sub> (V)	PACKAGE DESCRIPTION	SPECIFIED TEMPERATURE RANGE	ORDERING NUMBER	PACKAGE MARKING	PACKING OPTION
SGM66055	4.5	WLCSP-1.21×1.21-9B	-40°C to +85°C	SGM66055-4.5YG/TR	M9E XXXX	Tape and Reel, 3000
	5.0	WLCSP-1.21×1.21-9B	-40°C to +85°C	SGM66055-5.0YG/TR	GW6 XXXX	Tape and Reel, 3000
	5.4	WLCSP-1.21×1.21-9B	-40°C to +85°C	SGM66055-5.4YG/TR	GW7 XXXX	Tape and Reel, 3000
	5.0	TDFN-2×3-8BL	-40°C to +85°C	SGM66055-5.0YTDC8G/TR	MC3 XXXX	Tape and Reel, 3000

**MARKING INFORMATION**

**WLCSP-1.21×1.21-9B**

(1) XXXX = Date Code.

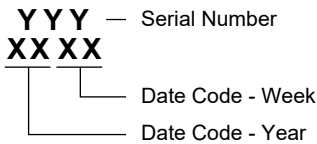

**TDFN-2×3-8BL**

(3) XXXX = Date Code and Trace Code.

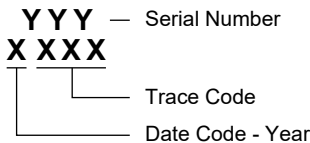

**SGM66055-5.0: WLCSP-1.21×1.21-9B**

(2) XXXX = Date Code and Trace Code.

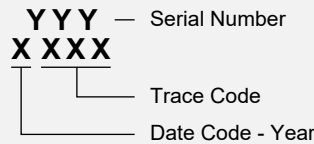

Green (RoHS & HSF): SG Micro Corp defines "Green" to mean Pb-Free (RoHS compatible) and free of halogen substances. If you have additional comments or questions, please contact your SGMICRO representative directly.

**ABSOLUTE MAXIMUM RATINGS**

Voltage on VIN Pin .....	-0.3V to 5.5V
Voltage on VOUT Pin .....	6V
SW Node (DC).....	-0.3V to 6V
SW Node (Transient: 10ns, 3MHz) .....	-1V to 8V
Voltage on Other Pins.....	-0.3V to 6V <sup>(1)</sup>
Package Thermal Resistance	
WLCSP-1.21×1.21-9B, $\theta_{JA}$ .....	90°C/W
TDFN-2×3-8BL, $\theta_{JA}$ .....	85°C/W
Junction Temperature.....	+150°C
Storage Temperature Range .....	-65°C to +150°C
Lead Temperature (Soldering, 10s).....	+260°C
ESD Susceptibility	
HBM.....	4000V
MM.....	400V
CDM .....	1000V

NOTE: 1. Lesser of 6V or V<sub>IN</sub> + 0.3V.

**OVERSTRESS CAUTION**

Stresses beyond those listed in Absolute Maximum Ratings may cause permanent damage to the device. Exposure to absolute maximum rating conditions for extended periods may affect reliability. Functional operation of the device at any conditions beyond those indicated in the Recommended Operating Conditions section is not implied.

**ESD SENSITIVITY CAUTION**

This integrated circuit can be damaged by ESD if you don't pay attention to ESD protection. SGMICRO recommends that all integrated circuits be handled with appropriate precautions. Failure to observe proper handling and installation procedures can cause damage. ESD damage can range from subtle performance degradation to complete device failure. Precision integrated circuits may be more susceptible to damage because very small parametric changes could cause the device not to meet its published specifications.

**DISCLAIMER**

SG Micro Corp reserves the right to make any change in circuit design, or specifications without prior notice.

PIN CONFIGURATIONS

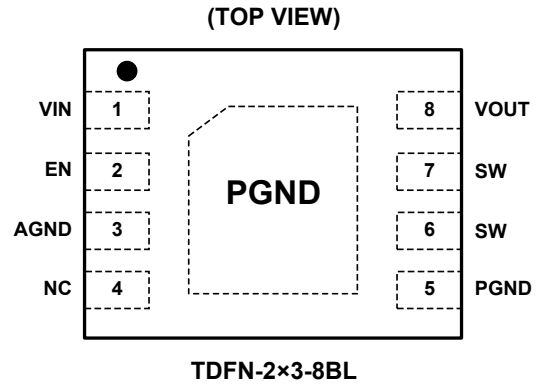
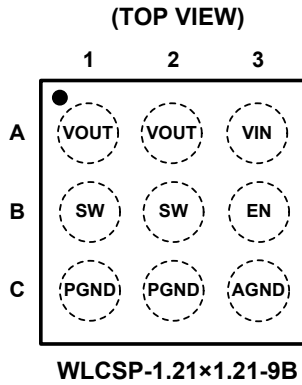

PIN DESCRIPTION

WLCSP-1.21×1.21-9B	TDFN-2×3-8BL	NAME	FUNCTION
A1, A2	8	VOUT	Output Voltage. This pin is the output voltage terminal; connect directly to C <sub>OUT</sub> .
A3	1	VIN	Input Voltage. Connect to Li-Ion battery input power source and the bias supply for the gate drivers.
B1, B2	6, 7	SW	Switching Node. Connect to inductor.
B3	2	EN	Enable. When this pin is high, the circuit is enabled.
C1, C2	5	PGND	Power Ground. This is the power return for the IC. C <sub>OUT</sub> capacitor should be returned with the shortest path possible to these pins.
C3	3	AGND	Analog Ground. This is the signal ground reference for the IC. All voltage levels are measured with respect to this pin – connect to PGND at a single point.
—	4	NC	No Connection.
—	Exposed Pad	PGND	Exposed Pad. Exposed pad is internally connected to PGND.

**ELECTRICAL CHARACTERISTICS**(V<sub>IN</sub> = 3.6V, Full = -40°C to +85°C, typical values are at T<sub>A</sub> = +25°C, unless otherwise noted.)

PARAMETER	SYMBOL	CONDITIONS	TEMP	MIN	TYP	MAX	UNITS	
<b>DC/DC STAGE</b>								
Input Voltage Range	V <sub>IN</sub>		+25°C	2.5		4.5	V	
Switching Frequency	f		Full	1.80	2.20	2.55	MHz	
Switch Current Limit	I <sub>L</sub>	SGM66055-4.5/5.0	+25°C	3.3	4.2	4.8	A	
		SGM66055-5.4	+25°C	2.1	3.0	3.6		
Start-Up Current Limit			+25°C		700		mA	
Boost Switch On-Resistance		V <sub>OUT</sub> = 5.0V	WLCSP	+25°C		50	65	mΩ
			TDFN	+25°C		85	105	
Rectifying Switch On-Resistance		V <sub>OUT</sub> = 5.0V	WLCSP	+25°C		60	80	mΩ
			TDFN	+25°C		95	115	
Output Voltage		SGM66055-4.5	Full	4.40	4.50	4.64	V	
		SGM66055-5.0	Full	4.89	5.00	5.15		
		SGM66055-5.4	Full	5.30	5.40	5.56		
Line Regulation		V <sub>IN</sub> = 2.5V to V <sub>OUT</sub> - 0.5V	+25°C		0.1		%	
Load Regulation			+25°C		0.2		%	
Quiescent Current	I <sub>Q</sub>	V <sub>EN</sub> = V <sub>IN</sub> = 3.6V, not switching	+25°C		23	33	μA	
Shutdown Current		V <sub>EN</sub> = 0V, V <sub>IN</sub> = 3.6V	+25°C			1	μA	
<b>CONTROL STAGE</b>								
EN Input Low Voltage	V <sub>IL</sub>		Full			0.4	V	
EN Input High Voltage	V <sub>IH</sub>		Full	1.3			V	
EN Input Current		Clamped on GND or VIN	Full	-1		1	μA	
Over-Temperature Protection					150		°C	
Over-Temperature Hysteresis					20		°C	

TYPICAL PERFORMANCE CHARACTERISTICS

At  $T_A = +25^\circ\text{C}$ ,  $V_{IN} = 3.6\text{V}$ ,  $C_{IN} = 10\mu\text{F}$ ,  $C_{OUT} = 20\mu\text{F}$ , unless otherwise noted.

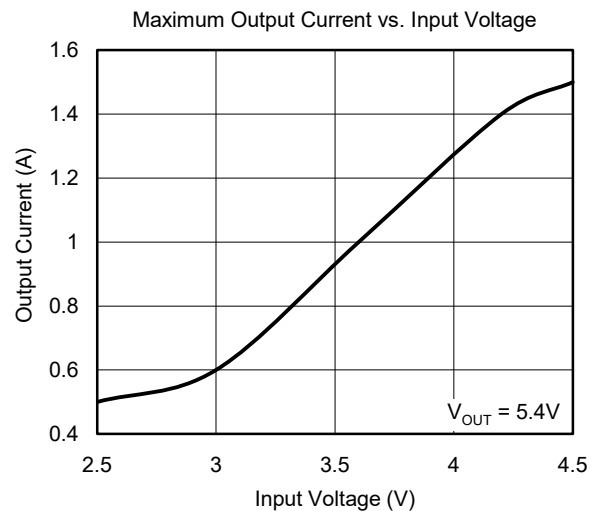
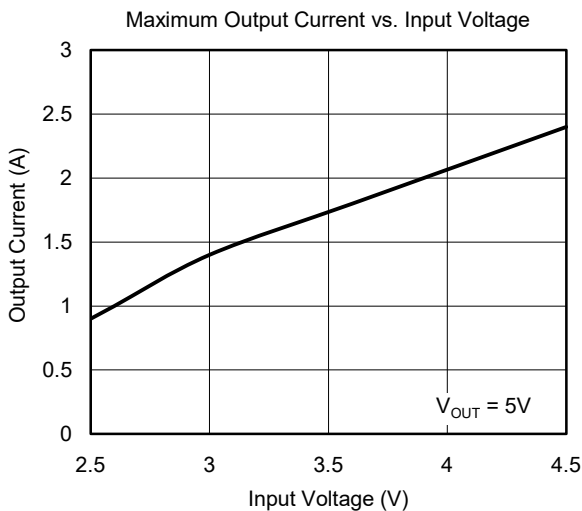
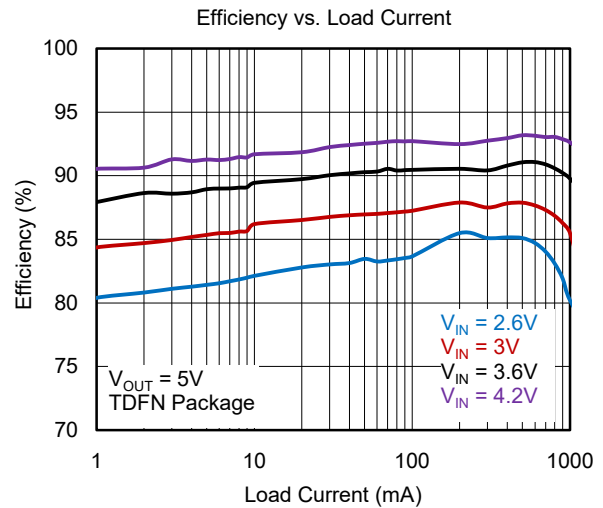
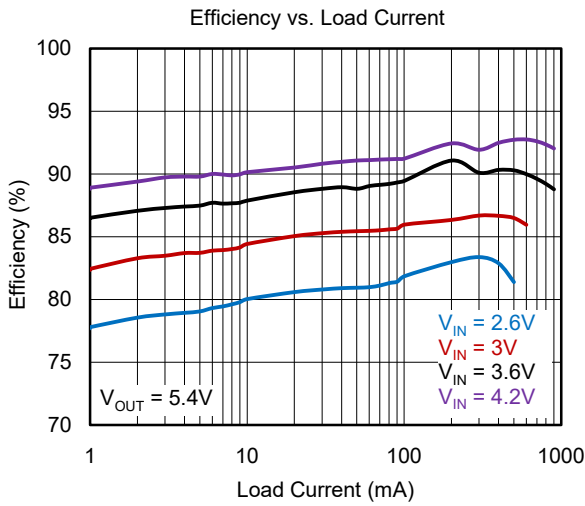
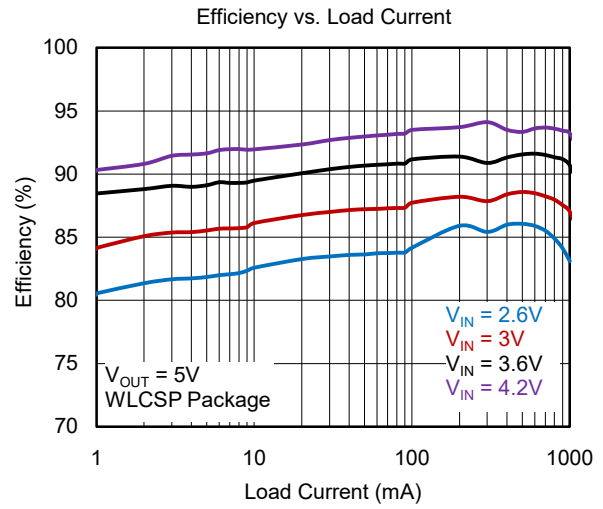
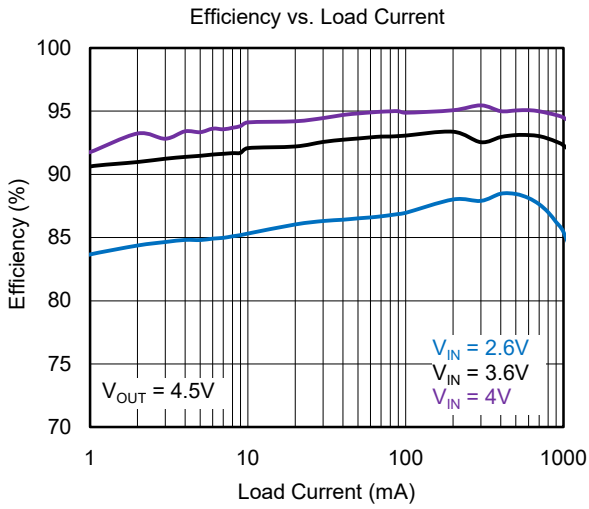

TYPICAL PERFORMANCE CHARACTERISTICS (continued)

At  $T_A = +25^\circ\text{C}$ ,  $V_{IN} = 3.6\text{V}$ ,  $C_{IN} = 10\mu\text{F}$ ,  $C_{OUT} = 20\mu\text{F}$ , unless otherwise noted.

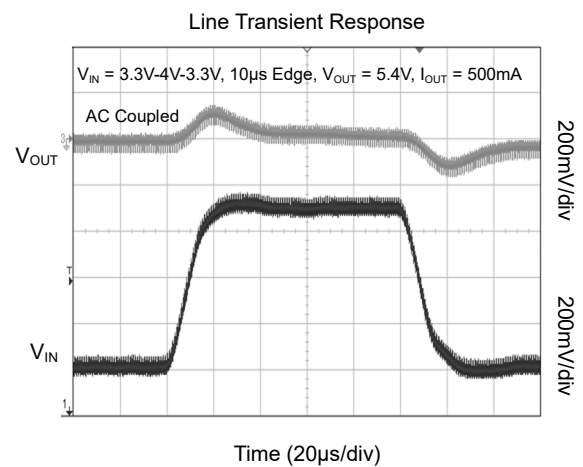
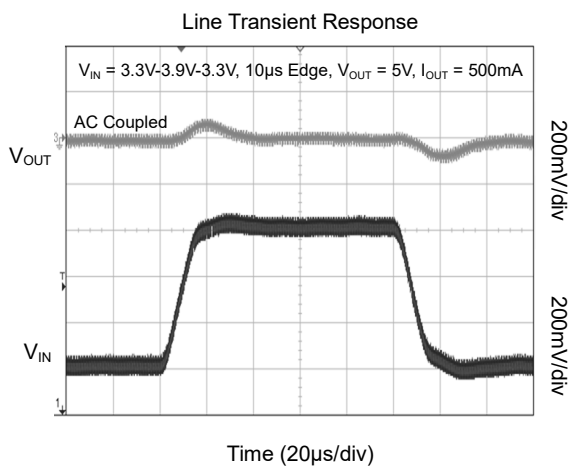
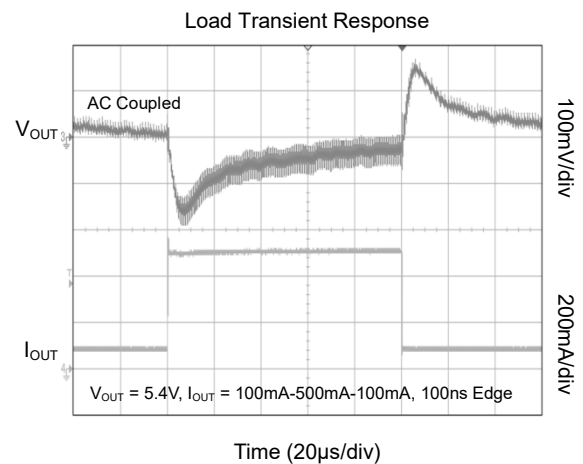
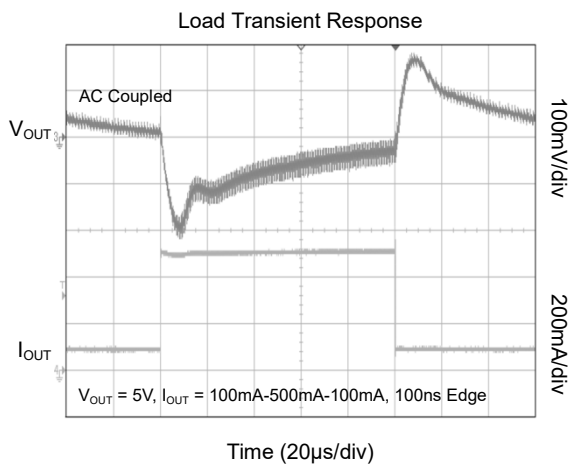
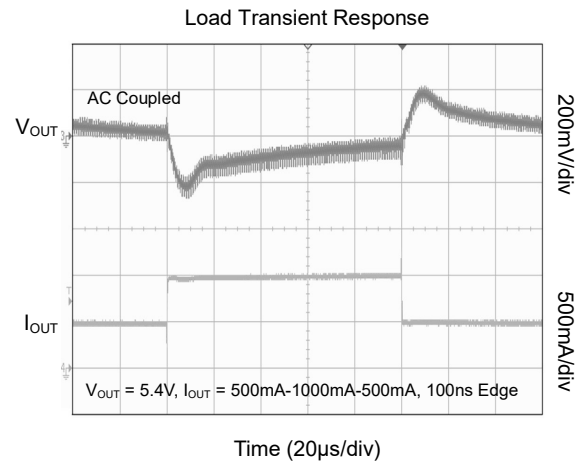
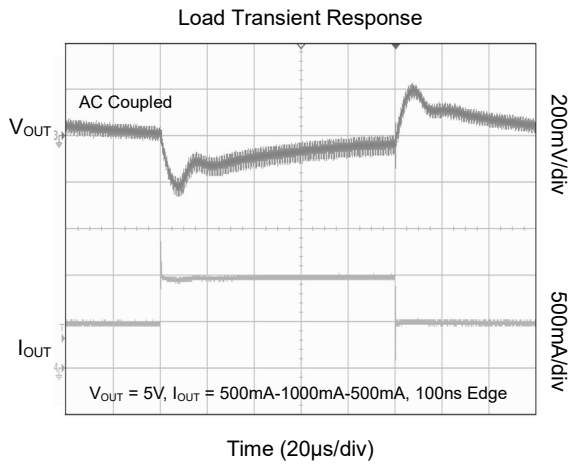

TYPICAL PERFORMANCE CHARACTERISTICS (continued)

At  $T_A = +25^\circ\text{C}$ ,  $V_{IN} = 3.6\text{V}$ ,  $C_{IN} = 10\mu\text{F}$ ,  $C_{OUT} = 20\mu\text{F}$ , unless otherwise noted.

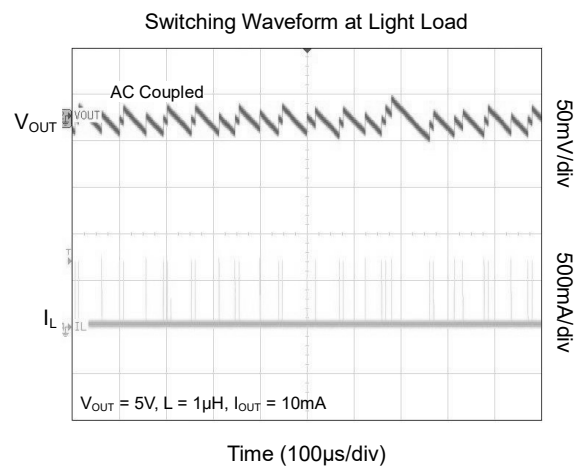
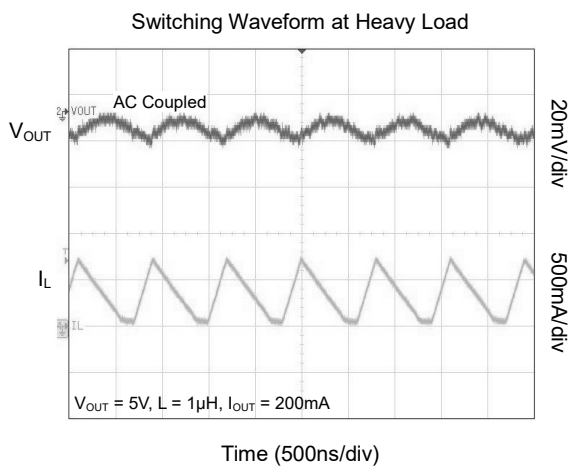
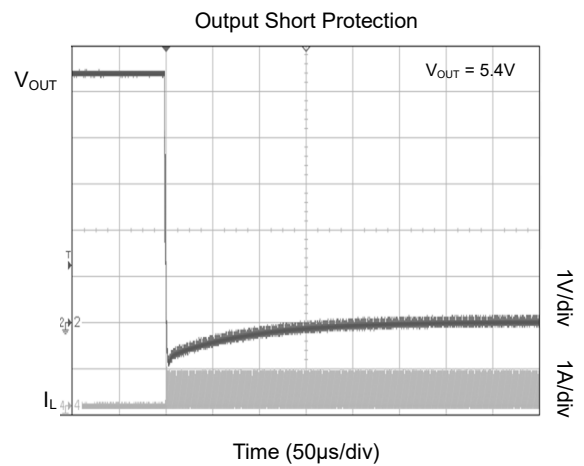
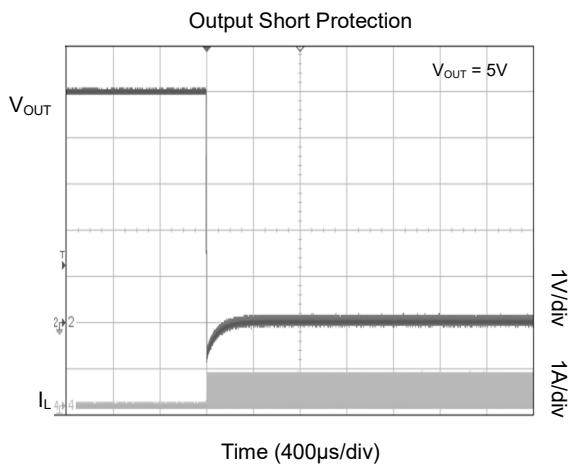
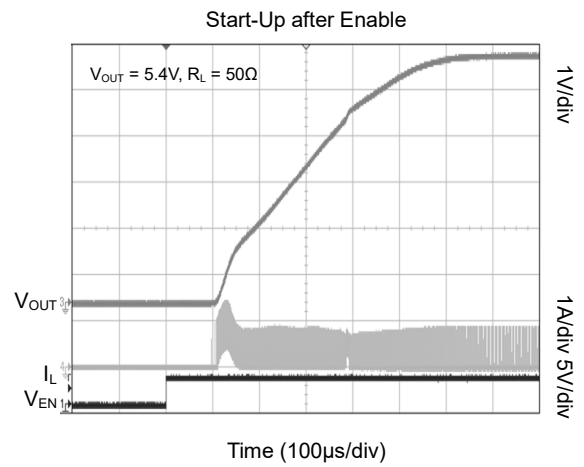
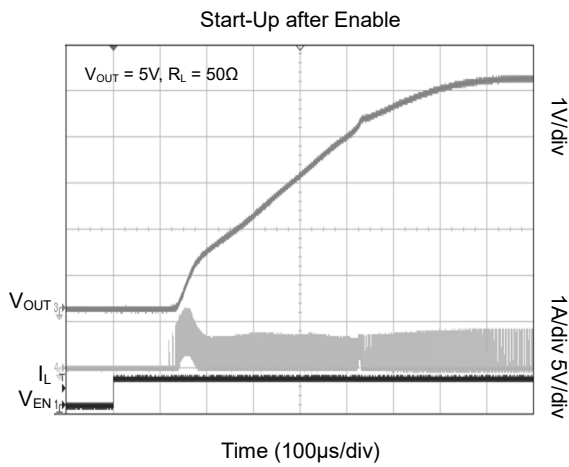

**TYPICAL PERFORMANCE CHARACTERISTICS (continued)**

At  $T_A = +25^\circ\text{C}$ ,  $V_{IN} = 3.6\text{V}$ ,  $C_{IN} = 10\mu\text{F}$ ,  $C_{OUT} = 20\mu\text{F}$ , unless otherwise noted.

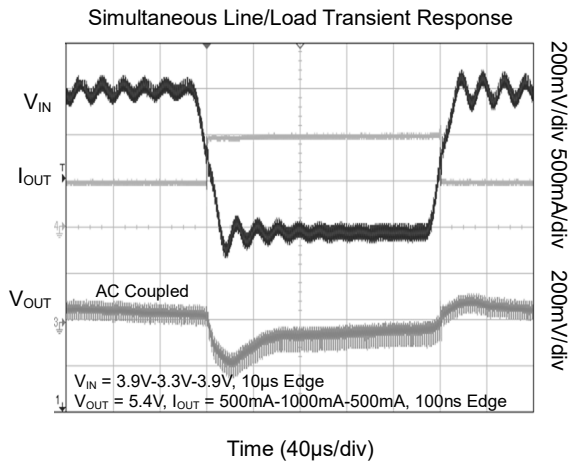



FUNCTIONAL BLOCK DIAGRAM

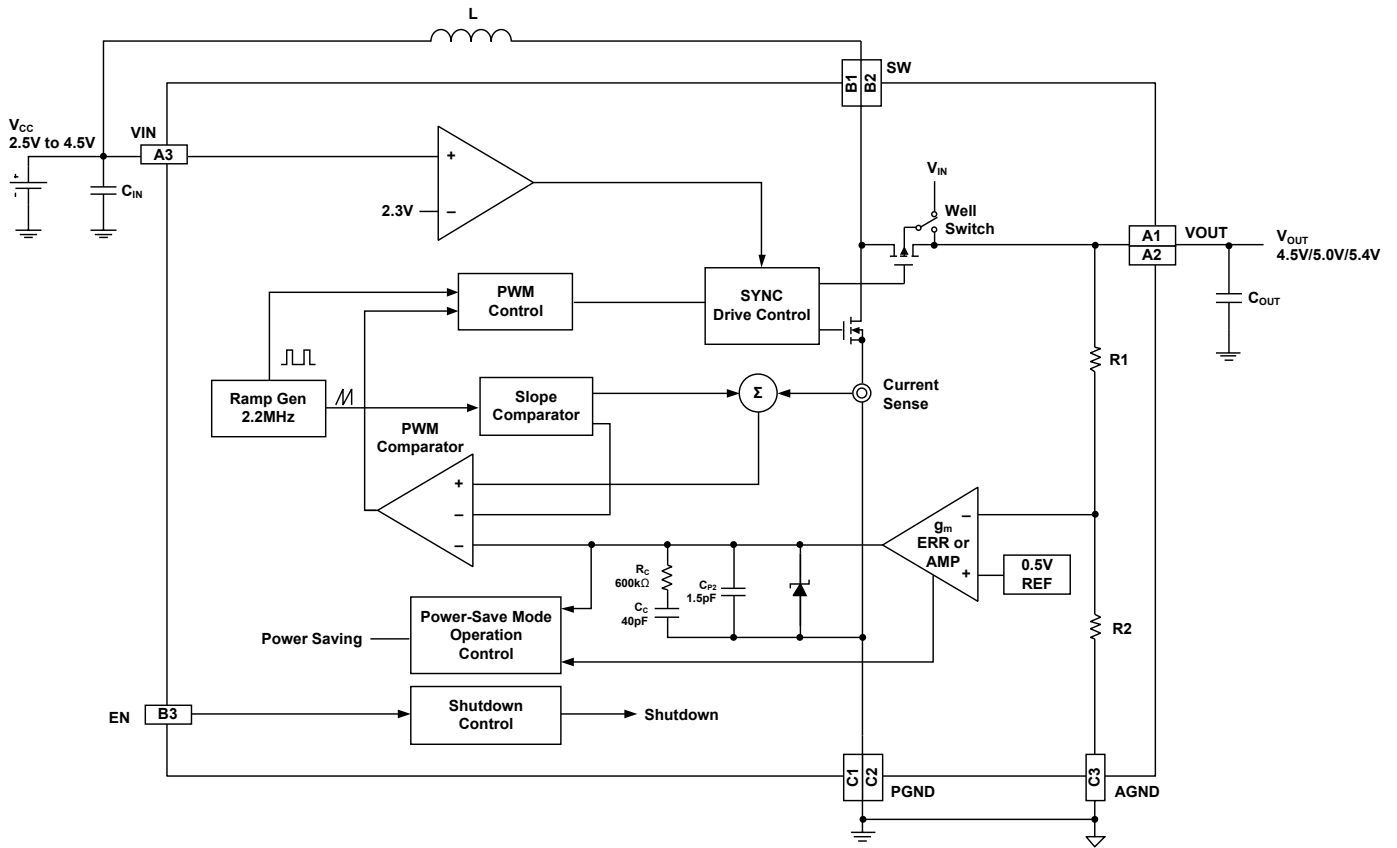

Figure 2. SGM66055 Block Diagram

## APPLICATION INFORMATION

The SGM66055 is a boost DC/DC converter operating in 2.5V to 4.5V supply range, for generating a regulated output voltage which can be set to as low as 10% above the supply voltage. An inductor, an output storage capacitor and an input decoupling capacitor should be selected to ensure proper performance desired in a specific application circuit.

### Inductor Selection

The device has been optimized to operate with inductance values between 0.22μH and 1μH. Nevertheless, operation with higher inductance values may be possible. Both average current and peak current should be evaluated in inductor selection. The maximum average inductor current is estimated using Equation 1:

$$I_L = I_{OUT} \times \frac{V_{OUT}}{V_{IN} \times 0.8} \quad (1)$$

For example, for an output current of 300mA at 5V, at least an average current of 700mA flows through the inductor at a minimum input voltage of 2.5V.

Choosing a proper inductance for a given current ripple value is readily done in design practice. A smaller ripple reduces the magnetic hysteresis losses in the inductor, as well as output voltage ripple and EMI. Though regulation settle time may rise when load changes. The minimum inductance value for the inductor at given condition is estimated by using Equation 2:

$$L = \frac{V_{IN} \times (V_{OUT} - V_{IN})}{\Delta I_L \times f \times V_{OUT}} \quad (2)$$

where  $f$  is the switching frequency and  $\Delta I_L$  is the ripple current in the inductor, which normally is 20% of the average inductor current or is a design specified value. In typical applications, a 0.47μH inductance is recommended. After choosing an inductor, peak current at maximum loading and lowest input voltage is suggested to be evaluated, which should be lower than the switch current limit of this device as well as the inductor saturation current.

### Input Capacitor

At least a 10μF input capacitor is recommended to improve transient behavior of the regulator and EMI behavior. A ceramic capacitor or a tantalum capacitor with a 100nF ceramic capacitor in parallel, placed close to the IC, is recommended.

### Output Capacitor

The capacitance and the ESR define the output voltage ripple. Supposing that the ESR is zero, the minimum capacitance could be estimated by using Equation 3:

$$C_{MIN} = \frac{I_{OUT} \times (V_{OUT} - V_{IN})}{f \times \Delta V \times V_{OUT}} \quad (3)$$

where  $f$  is the switching frequency and  $\Delta V$  is the maximum allowed voltage ripple.

The ESR and the additional ripple related to ESR may be negligible if a low ESR ceramic capacitor is used. This part of ESR component is calculated using Equation 4:

$$\Delta V_{ESR} = I_{OUT} \times R_{ESR} \quad (4)$$

The total ripple is the sum of the ripple caused by the capacitance and the ripple caused by the ESR of the capacitor. Additional voltage change may be caused by load transients; the output capacitor has to completely supply the load during the charging phase of the inductor.

The value of the output capacitance depends on the speed of the load transients and the load current during the load change. With the calculated minimum value of 10μF and load transient considerations, the recommended output capacitance value is in the range of 10μF to 47μF.

The capacitance loss due to the DC biasing and the high frequency performance has to be counted for de-rating. For example, larger form factor capacitors (in 1206 size) have their self-resonant frequencies in the same frequency range as the SGM66055 operating frequency. The effective capacitance of the capacitor may be significantly lower than its rating.

**APPLICATION INFORMATION (continued)**

**Layout Considerations**

Careful layout is always important to ensure good performance and stable operation to any kind of switching regulators. Place the capacitors close to the device, use the GND pin of the device as the center of star-connection to other grounds, and minimize the trace area of SW node. These measures reduce transient current loops and lower the possible parasitic ringing.

If a resistor divider is employed, the center tap to FB trace should have sufficient clearance from noisy PCB traces, as the FB node is sensitive and easily picks up noise.

**Thermal Information**

Implementation of integrated circuits in low-profile and fine-pitch surface-mount packages typically requires attention to power dissipation. Many system-dependent issues such as thermal coupling, airflow, added heat sinks and convection surfaces, and the presence of other heat-generating components affect the power dissipation limits of a given component.

Common approaches for enhancing thermal performance are listed below for convenient reference:

1. Improving the power dissipation capability of the PCB design.
2. Improving the thermal coupling of the component to the PCB.
3. Introducing airflow in the system.

**REVISION HISTORY**

NOTE: Page numbers for previous revisions may differ from page numbers in the current version.

	<b>Page</b>
<b>FEBRUARY 2021 – REV.A to REV.A.1</b>	
Updated Marking Information section.....	2
<b>Changes from Original (AUGUST 2018) to REV.A</b>	
Changed from product preview to production data.....	All

## PACKAGE OUTLINE DIMENSIONS

### TDFN-2x3-8BL

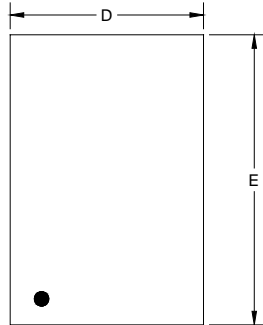

TOP VIEW

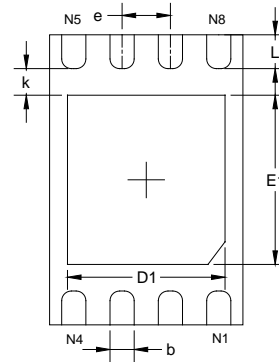

BOTTOM VIEW

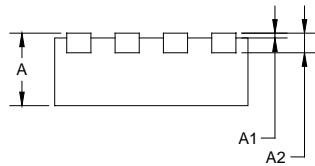

SIDE VIEW

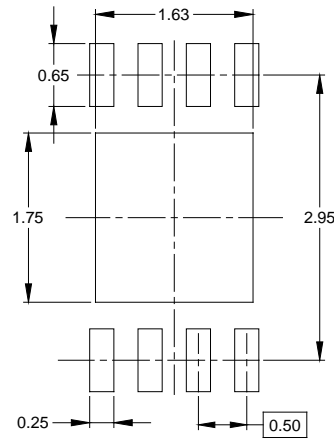

RECOMMENDED LAND PATTERN (Unit: mm)

Symbol	Dimensions In Millimeters		Dimensions In Inches	
	MIN	MAX	MIN	MAX
A	0.700	0.800	0.028	0.031
A1	0.000	0.050	0.000	0.002
A2	0.203 REF		0.008 REF	
D	1.950	2.050	0.077	0.081
D1	1.530	1.730	0.060	0.068
E	2.950	3.050	0.116	0.120
E1	1.650	1.850	0.065	0.073
b	0.200	0.300	0.008	0.012
e	0.500 BSC		0.020 BSC	
k	0.250 REF		0.010 REF	
L	0.300	0.450	0.012	0.018

**PACKAGE OUTLINE DIMENSIONS**

**WLCSP-1.21×1.21-9B**

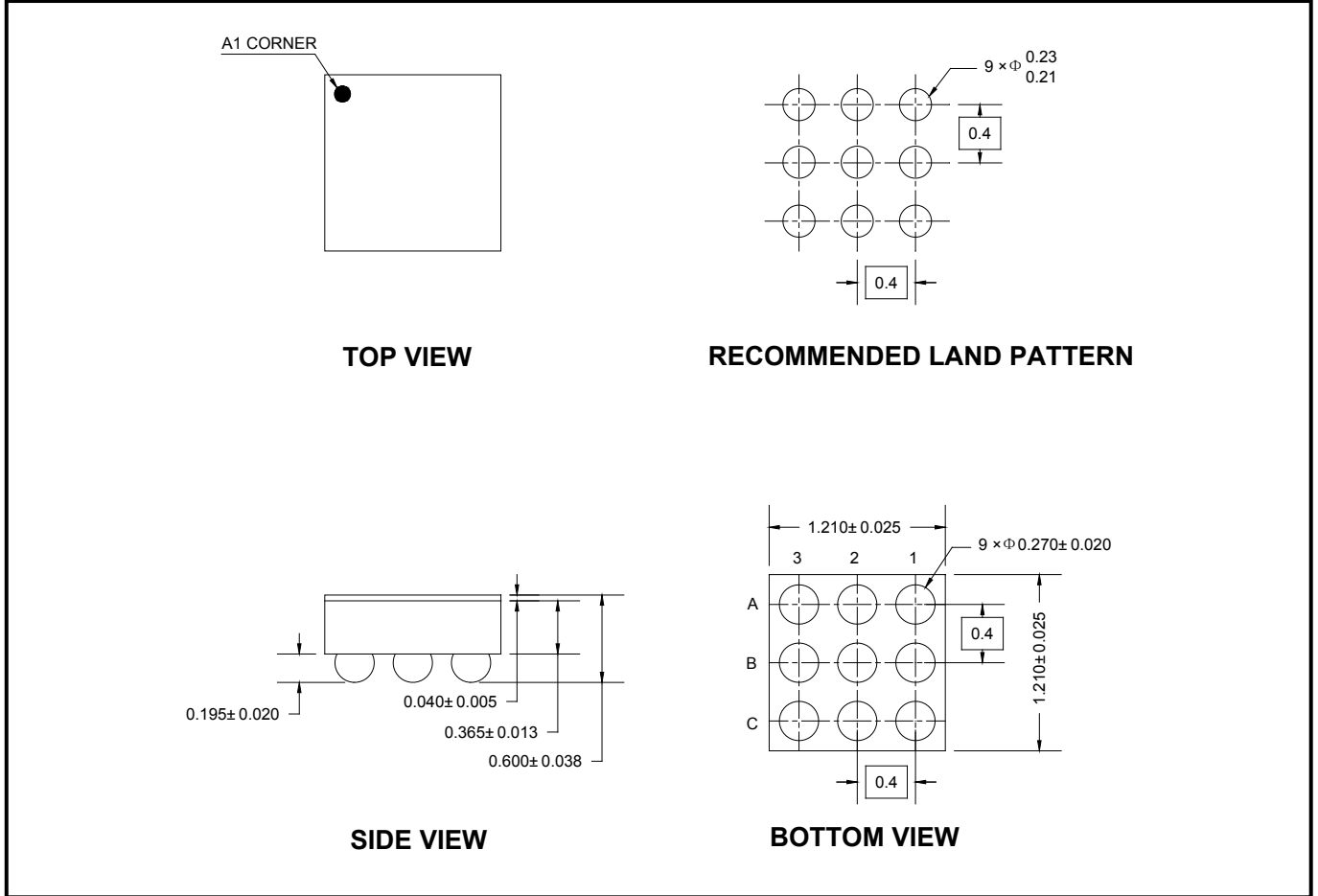

NOTE: All linear dimensions are in millimeters.

## TAPE AND REEL INFORMATION

### REEL DIMENSIONS

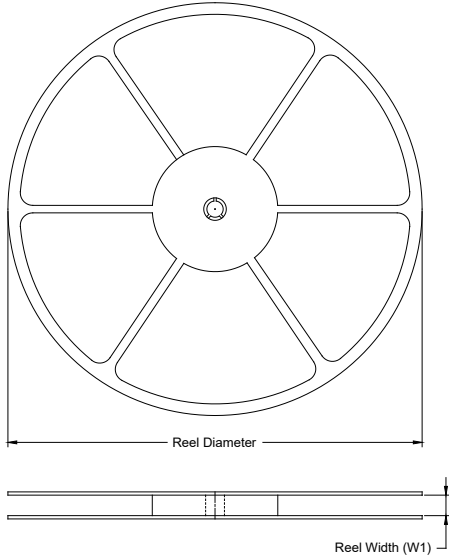

### TAPE DIMENSIONS

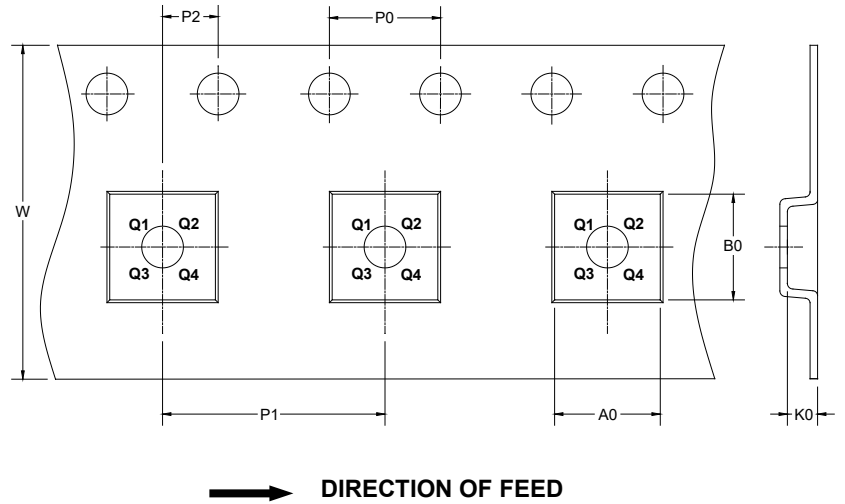

NOTE: The picture is only for reference. Please make the object as the standard.

### KEY PARAMETER LIST OF TAPE AND REEL

Package Type	Reel Diameter	Reel Width W1 (mm)	A0 (mm)	B0 (mm)	K0 (mm)	P0 (mm)	P1 (mm)	P2 (mm)	W (mm)	Pin1 Quadrant
TDFN-2×3-8BL	7"	9.5	2.30	3.30	1.10	4.0	4.0	2.0	8.0	Q2
WLCSP-1.21×1.21-9B	7"	9.2	1.33	1.33	0.74	4.0	4.0	2.0	8.0	Q1

000001

# PACKAGE INFORMATION

## CARTON BOX DIMENSIONS



NOTE: The picture is only for reference. Please make the object as the standard.

## KEY PARAMETER LIST OF CARTON BOX

Reel Type	Length (mm)	Width (mm)	Height (mm)	Pizza/Carton
7" (Option)	368	227	224	8
7"	442	410	224	18

DD0002