

# 74AHC14 Hex Inverter with Schmitt Trigger Inputs

## GENERAL DESCRIPTION

The 74AHC14 is a hex inverter with Schmitt trigger inputs. The device is designed for 2.0V to 5.5V  $V_{CC}$  operation.

This device has the capability to convert the slowly changing input signals into clearly defined, jitter-free output signals. The device performs the Boolean function  $Y = \bar{A}$ .

## FEATURES

- **Wide Operating Voltage Range: 2.0V to 5.5V**
- **Inputs Accept Voltages Higher than the Supply Voltage**
- **+8mA/-8mA Output Current**
- **All Inputs with Schmitt Trigger Actions**
- **-40°C to +125°C Operating Temperature Range**
- **Available in a Green SOIC-14 Package**

## LOGIC DIAGRAM

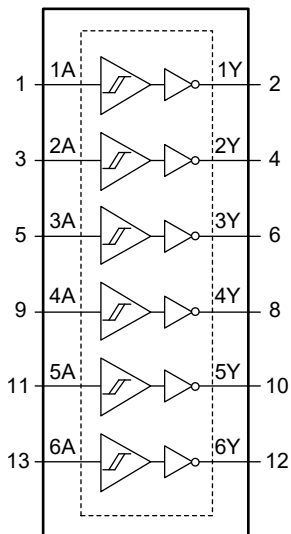

## FUNCTION TABLE

INPUT	OUTPUT
nA	nY
L	H
H	L

$$Y = \bar{A}$$

H = High Voltage Level

L = Low Voltage Level

## PACKAGE/ORDERING INFORMATION

MODEL	PACKAGE DESCRIPTION	SPECIFIED TEMPERATURE RANGE	ORDERING NUMBER	PACKAGE MARKING	PACKING OPTION
74AHC14	SOIC-14	-40°C to +125°C	74AHC14XS14G/TR	74AHC14XS14 XXXXX	Tape and Reel, 2500

## MARKING INFORMATION

NOTE: XXXXX = Date Code, Trace Code and Vendor Code.

**XXXXX**

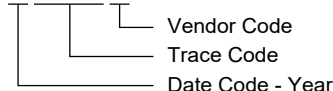

Green (RoHS & HSF): SG Micro Corp defines "Green" to mean Pb-Free (RoHS compatible) and free of halogen substances. If you have additional comments or questions, please contact your SGMICRO representative directly.

ABSOLUTE MAXIMUM RATINGS <sup>(1)</sup>

Supply Voltage Range, $V_{CC}$	-0.5V to 7V
Input Voltage Range, $V_I$ <sup>(2)</sup>	-0.5V to 7V
Output Voltage Range, $V_O$ <sup>(2)</sup>	-0.5V to $V_{CC} + 0.5V$
Input Clamping Current, $I_{IK}$ ( $V_I < -0.5V$ )	-20mA
Output Clamping Current, $I_{OK}$ ( $V_O < -0.5V$ or $V_O > (V_{CC} + 0.5V)$ )	$\pm 20mA$
Output Current, $I_O$	
Output in High-State	-25mA
Output in Low-State	25mA
Supply Current, $I_{CC}$	75mA
Ground Current, $I_{GND}$	-75mA
Junction Temperature <sup>(3)</sup>	+150°C
Storage Temperature Range	-65°C to +150°C
Lead Temperature (Soldering, 10s)	+260°C
ESD Susceptibility	
HBM	6000V
CDM	1000V

## RECOMMENDED OPERATING CONDITIONS

Supply Voltage Range, $V_{CC}$	2.0V to 5.5V
Input Voltage Range, $V_I$	0V to 5.5V
Output Voltage Range, $V_O$	0V to $V_{CC}$
High-Level Output Current, $I_{OH}$	-8mA
Low-Level Output Current, $I_{OL}$	8mA
Input Transition Rise and Fall Rate, $\Delta t/\Delta V$	
	10ns/V (MAX)
Operating Temperature Range	-40°C to +125°C

## OVERSTRESS CAUTION

- Stresses beyond those listed in Absolute Maximum Ratings may cause permanent damage to the device. Exposure to absolute maximum rating conditions for extended periods may affect reliability. Functional operation of the device at any conditions beyond those indicated in the Recommended Operating Conditions section is not implied.
- The input and output negative voltage ratings may be exceeded if the input and output clamp current ratings are observed.
- The performance capability of a high-performance integrated circuit in conjunction with its thermal environment can create junction temperatures which are detrimental to reliability.

## ESD SENSITIVITY CAUTION

This integrated circuit can be damaged if ESD protections are not considered carefully. SGMICRO recommends that all integrated circuits be handled with appropriate precautions. Failure to observe proper handling and installation procedures can cause damage. ESD damage can range from subtle performance degradation to complete device failure. Precision integrated circuits may be more susceptible to damage because even small parametric changes could cause the device not to meet the published specifications.

## DISCLAIMER

SG Micro Corp reserves the right to make any change in circuit design, or specifications without prior notice.

## PIN CONFIGURATION

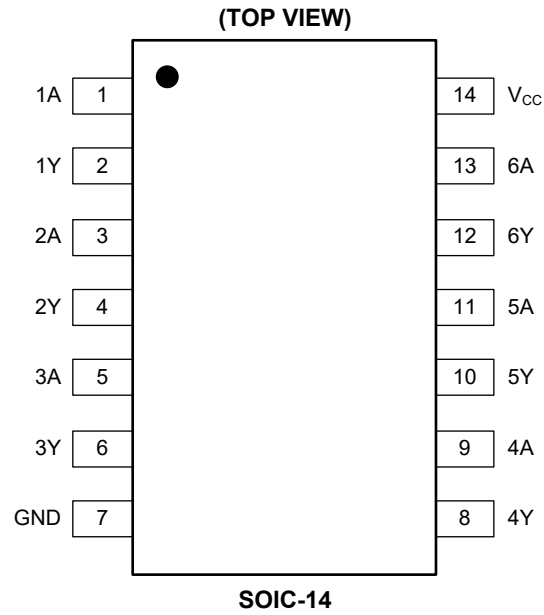

## PIN DESCRIPTION

PIN	NAME	FUNCTION
1, 3, 5, 9, 11, 13	1A, 2A, 3A, 4A, 5A, 6A	Data Inputs.
2, 4, 6, 8, 10, 12	1Y, 2Y, 3Y, 4Y, 5Y, 6Y	Data Outputs.
7	GND	Ground.
14	V <sub>CC</sub>	Supply Voltage.

## ELECTRICAL CHARACTERISTICS

(Full = -40°C to +125°C, all typical values are measured at  $T_A = +25^\circ\text{C}$ , unless otherwise noted.)

PARAMETER	SYMBOL	CONDITIONS	TEMP	MIN	TYP	MAX	UNITS	
High-Level Output Voltage	$V_{OH}$	$V_I = V_{T+}$ or $V_{T-}$	$I_O = -50\mu\text{A}$ , $V_{CC} = 2.0\text{V}$	Full	1.95	1.995	V	
			$I_O = -50\mu\text{A}$ , $V_{CC} = 3.0\text{V}$	Full	2.95	2.995		
			$I_O = -50\mu\text{A}$ , $V_{CC} = 4.5\text{V}$	Full	4.45	4.495		
			$I_O = -4\text{mA}$ , $V_{CC} = 3.0\text{V}$	Full	2.6	2.85		
			$I_O = -8\text{mA}$ , $V_{CC} = 4.5\text{V}$	Full	4	4.25		
Low-Level Output Voltage	$V_{OL}$	$V_I = V_{T+}$ or $V_{T-}$	$I_O = 50\mu\text{A}$ , $V_{CC} = 2.0\text{V}$	Full		0.005	0.05	V
			$I_O = 50\mu\text{A}$ , $V_{CC} = 3.0\text{V}$	Full		0.005	0.05	
			$I_O = 50\mu\text{A}$ , $V_{CC} = 4.5\text{V}$	Full		0.005	0.05	
			$I_O = 4\text{mA}$ , $V_{CC} = 3.0\text{V}$	Full		0.15	0.4	
			$I_O = 8\text{mA}$ , $V_{CC} = 4.5\text{V}$	Full		0.25	0.5	
Input Leakage Current	$I_I$	$V_I = 5.5\text{V}$ or GND, $V_{CC} = 0\text{V}$ to $5.5\text{V}$	Full		0.02	2	$\mu\text{A}$	
Supply Current	$I_{CC}$	$V_I = V_{CC}$ or GND, $V_{CC} = 5.5\text{V}$ , $I_O = 0\text{A}$	Full		0.02	10	$\mu\text{A}$	
Input Capacitance	$C_i$		+25°C		5		pF	
Output Capacitance	$C_o$		+25°C		5		pF	

## DYNAMIC CHARACTERISTICS

(For test circuit, see Figure 2. All typical values are measured at  $T_A = +25^\circ\text{C}$  and  $V_{CC} = 3\text{V}$ ,  $3.6\text{V}$ ,  $4.5\text{V}$  and  $5.5\text{V}$  respectively, unless otherwise noted.)

PARAMETER	SYMBOL	CONDITIONS	TEMP	MIN	TYP	MAX	UNITS
Propagation Delay <sup>(1)</sup>	$t_{PD}$	nA to nY, see Figure 3	$V_{CC} = 3.0\text{V}$ to $3.6\text{V}$ , $C_L = 15\text{pF}$	+25°C		7	ns
			$V_{CC} = 3.0\text{V}$ to $3.6\text{V}$ , $C_L = 50\text{pF}$	+25°C		8	
			$V_{CC} = 4.5\text{V}$ to $5.5\text{V}$ , $C_L = 15\text{pF}$	+25°C		7	
			$V_{CC} = 4.5\text{V}$ to $5.5\text{V}$ , $C_L = 50\text{pF}$	+25°C		8	
Power Dissipation Capacitance <sup>(2)</sup>	$C_{PD}$	$f_i = 1\text{MHz}$ , $V_I = \text{GND}$ to $V_{CC}$	+25°C		12		pF

## NOTES:

- $t_{PD}$  is the same as  $t_{PLH}$  and  $t_{PHL}$ .
- $C_{PD}$  is used to determine the dynamic power dissipation ( $P_D$  in  $\mu\text{W}$ ).  

$$P_D = C_{PD} \times V_{CC}^2 \times f_i \times N + \Sigma(C_L \times V_{CC}^2 \times f_o)$$
 where:  
 $f_i$  = Input frequency in MHz.  
 $f_o$  = Output frequency in MHz.  
 $C_L$  = Output load capacitance in pF.  
 $V_{CC}$  = Supply voltage in Volts.  
 $N$  = Number of inputs switching.  
 $\Sigma(C_L \times V_{CC}^2 \times f_o)$  = Sum of the outputs.

## TRANSFER CHARACTERISTICS

(Full =  $-40^{\circ}\text{C}$  to  $+125^{\circ}\text{C}$ , all typical values are measured at  $T_A = +25^{\circ}\text{C}$ , unless otherwise noted.)

PARAMETER	SYMBOL	CONDITIONS	TEMP	MIN	TYP	MAX	UNITS
Positive-Going Threshold Voltage	$V_{T+}$	$V_{CC} = 3.0\text{V}$	Full	1.2	1.85	2.2	V
		$V_{CC} = 4.5\text{V}$	Full	1.75	2.65	3.15	
		$V_{CC} = 5.5\text{V}$	Full	2.15	3.15	3.85	
Negative-Going Threshold Voltage	$V_{T-}$	$V_{CC} = 3.0\text{V}$	Full	0.9	1.25	1.9	V
		$V_{CC} = 4.5\text{V}$	Full	1.35	1.9	2.75	
		$V_{CC} = 5.5\text{V}$	Full	1.65	2.3	3.35	
Hysteresis Voltage	$V_H$	$V_{CC} = 3.0\text{V}$	Full	0.25	0.6	1.2	V
		$V_{CC} = 4.5\text{V}$	Full	0.35	0.75	1.4	
		$V_{CC} = 5.5\text{V}$	Full	0.45	0.85	1.6	

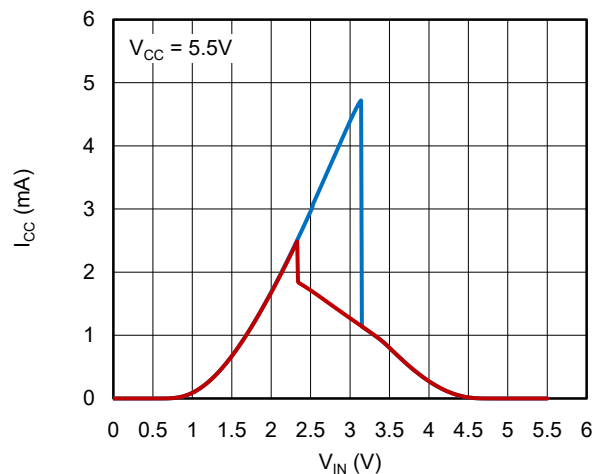
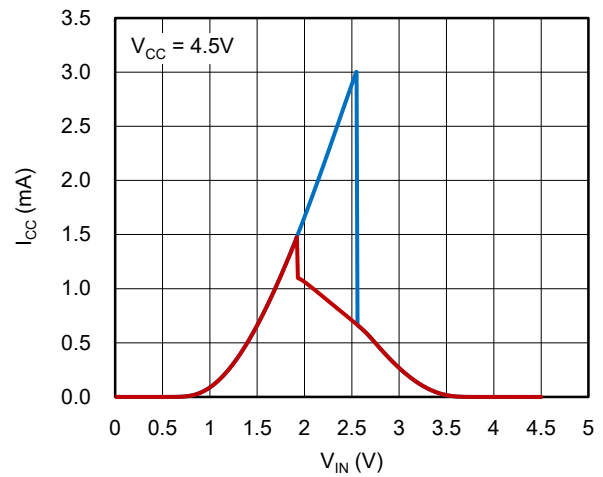
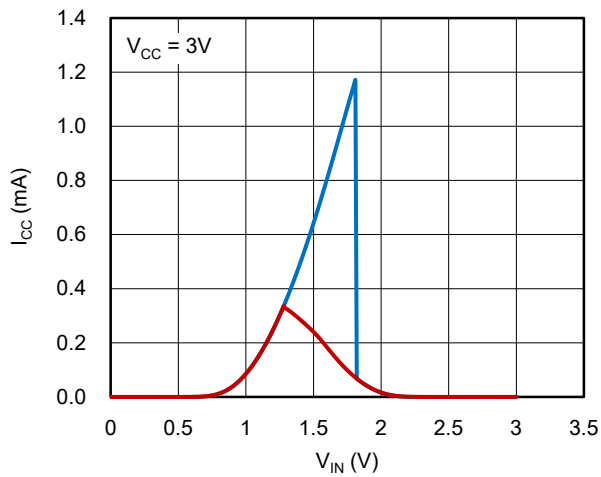
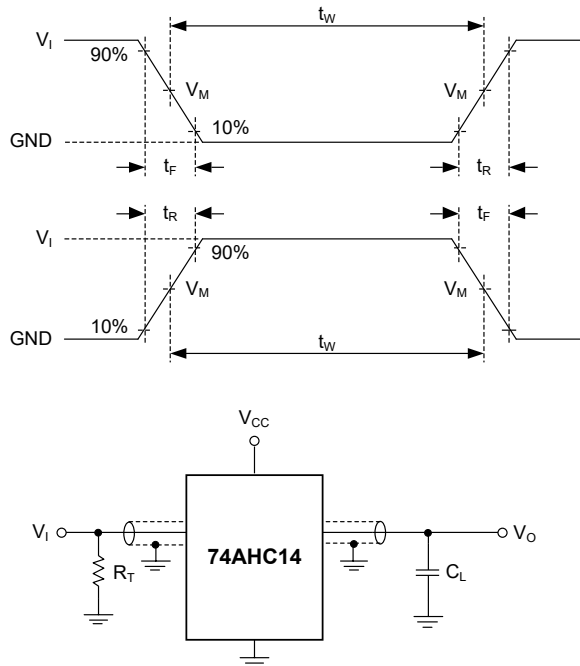

Figure 1. Typical Transfer Characteristics

TEST CIRCUIT



Test conditions are given in Table 1.

Definitions for test circuit:

$R_T$  = Termination resistance (equals to output impedance  $Z_O$  of the pulse generator).

$C_L$  = Load capacitance (includes jig and probe).

Figure 2. Test Circuit for Measuring Switching Times

Table 1. Test Conditions

SUPPLY VOLTAGE	INPUT		LOAD
$V_{CC}$	$V_I$	$t_R, t_F$	$C_L$
2.0V to 5.5V	$V_{CC}$	$\leq 3.0ns$	50pF, 15pF

WAVEFORMS

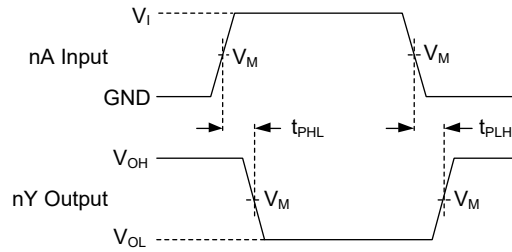

Test conditions are given in Table 1.  
 Measurement points are given in Table 2.  
 Logic levels:  $V_{OL}$  and  $V_{OH}$  are typical output voltage levels that occur with the output load.

Figure 3. Input nA to Output nY Propagation Delays

Table 2. Measurement Points

SUPPLY VOLTAGE	INPUT		OUTPUT
$V_{CC}$	$V_I$	$V_M^{(1)}$	$V_M$
2.0V to 5.5V	$V_{CC}$	$0.5 \times V_{CC}$	$0.5 \times V_{CC}$

NOTE: 1. The measurement points should be  $V_{IH}$  or  $V_{IL}$  when the input rising or falling time exceeds 3.0ns.

REVISION HISTORY

NOTE: Page numbers for previous revisions may differ from page numbers in the current version.

FEBRUARY 2022 – REV.A to REV.A.1	Page
Updated $V_O$ in Absolute Maximum Ratings section .....	2
Added $I_{OH}$ , $I_{OL}$ and $\Delta t/\Delta V$ in Recommended Operating Conditions section .....	2
Complemented Table 1 and Table 2 .....	6, 7
Changes from Original (APRIL 2021) to REV.A	Page
Changed from product preview to production data .....	All

# PACKAGE INFORMATION

## PACKAGE OUTLINE DIMENSIONS

### SOIC-14

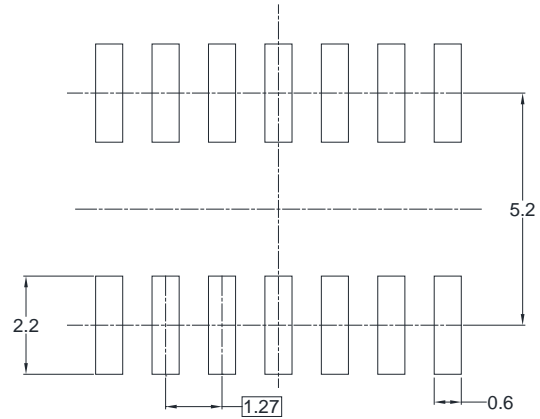
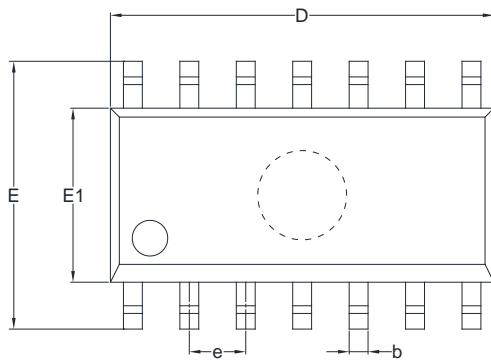

RECOMMENDED LAND PATTERN (Unit: mm)

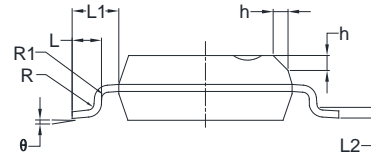
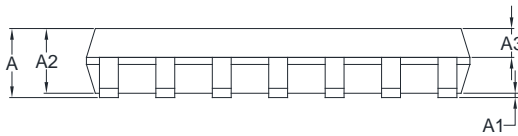

Symbol	Dimensions In Millimeters		Dimensions In Inches	
	MIN	MAX	MIN	MAX
A	1.35	1.75	0.053	0.069
A1	0.10	0.25	0.004	0.010
A2	1.25	1.65	0.049	0.065
A3	0.55	0.75	0.022	0.030
b	0.36	0.49	0.014	0.019
D	8.53	8.73	0.336	0.344
E	5.80	6.20	0.228	0.244
E1	3.80	4.00	0.150	0.157
e	1.27 BSC		0.050 BSC	
L	0.45	0.80	0.018	0.032
L1	1.04 REF		0.040 REF	
L2	0.25 BSC		0.01 BSC	
R	0.07		0.003	
R1	0.07		0.003	
h	0.30	0.50	0.012	0.020
$\theta$	0°	8°	0°	8°

**NOTES:**

1. Body dimensions do not include mode flash or protrusion.
2. This drawing is subject to change without notice.



# PACKAGE INFORMATION

## TAPE AND REEL INFORMATION

### REEL DIMENSIONS



### TAPE DIMENSIONS



NOTE: The picture is only for reference. Please make the object as the standard.

### KEY PARAMETER LIST OF TAPE AND REEL

Package Type	Reel Diameter	Reel Width W1 (mm)	A0 (mm)	B0 (mm)	K0 (mm)	P0 (mm)	P1 (mm)	P2 (mm)	W (mm)	Pin1 Quadrant
SOIC-14	13"	16.4	6.60	9.30	2.10	4.0	8.0	2.0	16.0	Q1

DD0001

# PACKAGE INFORMATION

## CARTON BOX DIMENSIONS



NOTE: The picture is only for reference. Please make the object as the standard.

## KEY PARAMETER LIST OF CARTON BOX

Reel Type	Length (mm)	Width (mm)	Height (mm)	Pizza/Carton
13"	386	280	370	5

DD0002