

SGM7SZ245

PACKAGE/ORDERING INFORMATION

MODEL	PACKAGE DESCRIPTION	SPECIFIED TEMPERATURE RANGE	ORDERING NUMBER	PACKAGE MARKING	PACKING OPTION
SGM7SZ245	TSSOP-20	-40°C to +125°C	SGM7SZ245XTS20G/TR	SGM7SZ245XTS20 XXXXX	Tape and Reel, 4000
	TQFN-3×3-20L	-40°C to +125°C	SGM7SZ245XTQG20G/TR	SGM A5QG XXXXX	Tape and Reel, 4000
	TQFN-5.5×3.5-24L	-40°C to +125°C	SGM7SZ245XTQQ24G/TR	SGM7SZ245 XTQQ XXXXX	Tape and Reel, 3000

NOTE: XXXXX = Date Code and Vendor Code.

Green (RoHS & HSF): SG Micro Corp defines "Green" to mean Pb-Free (RoHS compatible) and free of halogen substances. If you have additional comments or questions, please contact your SGMICRO representative directly.

ABSOLUTE MAXIMUM RATINGS

Supply Voltage Range, V_{CC} -0.3V to 6.0V
 Input Clamp Current, $I_{IK}^{(1)}$
 ($V_I < 0$ or $V_I > V_{CC}$) ± 20 mA
 Output Clamp Current, $I_{OK}^{(1)}$
 ($V_O < 0$ or $V_O > V_{CC}$) ± 20 mA
 Continuous Output Current, I_O ($V_O = 0V$ to V_{CC}) ± 40 mA
 Continuous Current through V_{CC} or GND ± 70 mA
 Junction Temperature +150°C
 Storage Temperature Range -65°C to +150°C
 Lead Temperature (Soldering, 10sec) +260°C

NOTE: 1. The input and output voltage ratings may be exceeded if the input and output current ratings are observed.

OVERSTRESS CAUTION

Stresses beyond those listed may cause permanent damage to the device. Functional operation of the device at these or any other conditions beyond those indicated in the operational section of the specification is not implied. Exposure to absolute maximum rating conditions for extended periods may affect reliability.

ESD SENSITIVITY CAUTION

This integrated circuit can be damaged by ESD if you don't pay attention to ESD protection. SGMICRO recommends that all integrated circuits be handled with appropriate precautions. Failure to observe proper handling and installation procedures can cause damage. ESD damage can range from subtle performance degradation to complete device failure. Precision integrated circuits may be more susceptible to damage because very small parametric changes could cause the device not to meet its published specifications.

RECOMMENDED OPERATING CONDITIONS (2)

Supply Voltage Range, V_{CC} 1.8V to 5.0V
 High-Level Input Voltage, V_{IH}
 ($V_{CC} = 1.8V$) 1.6V (MIN)
 ($V_{CC} = 3.3V$) 1.7V (MIN)
 ($V_{CC} = 5.0V$) 2V (MIN)
 Low-Level Input Voltage, V_{IL}
 ($V_{CC} = 1.8V$) 0.2V (MAX)
 ($V_{CC} = 3.3V$) 0.5V (MAX)
 ($V_{CC} = 5.0V$) 0.6V (MAX)
 Input Voltage Range, V_I 0V to V_{CC}
 Output Voltage Range, V_O 0V to V_{CC}
 Input Transition Rise or Fall Rate, $\Delta t/\Delta V$
 ($V_{CC} = 1.8V$) 500ns (MAX)
 ($V_{CC} = 3.3V$) 250ns (MAX)
 ($V_{CC} = 5.0V$) 200ns (MAX)
 Operating Temperature Range -40°C to +125°C

NOTE: 2. All unused inputs of the device must be held at V_{CC} or GND to ensure proper device operation.

DISCLAIMER

SG Micro Corp reserves the right to make any change in circuit design, specification or other related things if necessary without notice at any time.

PIN CONFIGURATIONS

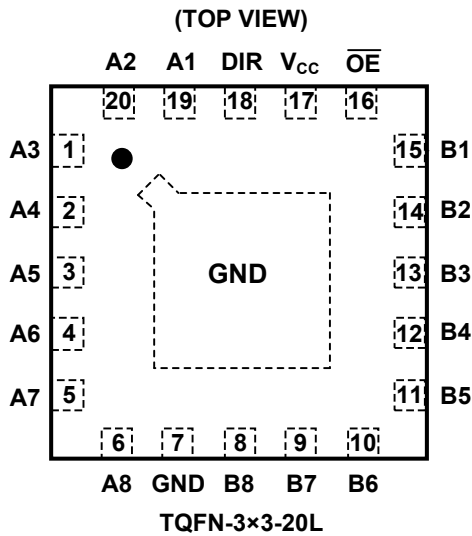
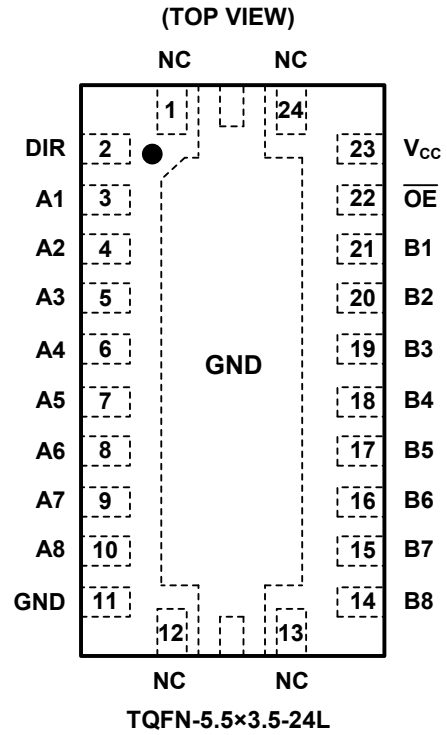
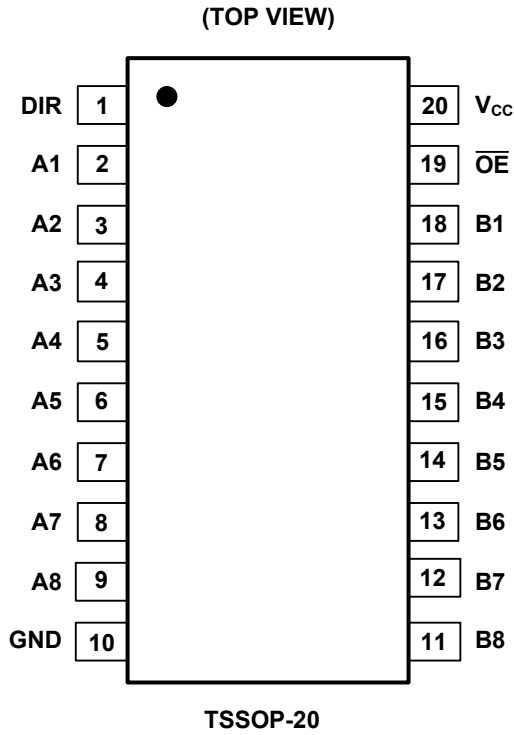

PIN DESCRIPTION

PIN			NAME	I/O	FUNCTION
TSSOP-20	TQFN-3×3-20L	TQFN-5.5×3.5-24L			
1	18	2	DIR	I	Direction-Control Signal.
2	19	3	A1	I/O	Input/Output A1.
3	20	4	A2	I/O	Input/Output A2.
4	1	5	A3	I/O	Input/Output A3.
5	2	6	A4	I/O	Input/Output A4.
6	3	7	A5	I/O	Input/Output A5.
7	4	8	A6	I/O	Input/Output A6.
8	5	9	A7	I/O	Input/Output A7.
9	6	10	A8	I/O	Input/Output A8.
10	7	11	GND	–	Ground.
11	8	14	B8	I/O	Input/Output B8.
12	9	15	B7	I/O	Input/Output B7.
13	10	16	B6	I/O	Input/Output B6.
14	11	17	B5	I/O	Input/Output B5.
15	12	18	B4	I/O	Input/Output B4.
16	13	19	B3	I/O	Input/Output B3.
17	14	20	B2	I/O	Input/Output B2.
18	15	21	B1	I/O	Input/Output B1.
19	16	22	$\overline{\text{OE}}$	I	3-State Output-Mode Enable. Pull $\overline{\text{OE}}$ high to place all outputs in 3-state mode.
20	17	23	V _{CC}	–	Supply Voltage. 1.8V ≤ V _{CC} ≤ 5.5V.
–	–	1, 12, 13, 24	NC	–	No Connection.
–	Exposed Pad	Exposed Pad	GND	–	Exposed pad is internally connected to GND. Connect it to a large ground plane to maximize thermal performance; not intended as an electrical connection point.

ELECTRICAL CHARACTERISTICS(Full = -40°C to +125°C, typical values are at T_A = +25°C, unless otherwise noted.)

PARAMETER		CONDITIONS		TEMP	MIN	TYP	MAX	UNITS
High-Level Output Voltage (V _{OH})	V _I = V _{IH}	I _{OH} = -20μA	V _{CC} = 1.8V	Full		1.799		V
			V _{CC} = 3.3V	Full		3.299		
			V _{CC} = 5.0V	Full		4.999		
		I _{OH} = -6mA, V _{CC} = 3.3V	+25°C		3.2			
		I _{OH} = -7.8mA, V _{CC} = 5.0V	+25°C		4.9			
Low-Level Output Voltage (V _{OL})	V _I = V _{IL}	I _{OL} = 20μA	V _{CC} = 1.8V	Full		0.002		V
			V _{CC} = 3.3V	Full		0.001		
			V _{CC} = 5.0V	Full		0.001		
		I _{OL} = 6mA, V _{CC} = 3.3V	+25°C		0.1			
		I _{OL} = 7.8mA, V _{CC} = 5.0V	+25°C		0.1			
Input Leakage Current (I _I)	DIR or $\overline{\text{OE}}$	V _{CC} = 5.0V, V _I = V _{CC} or 0V		Full		±0.1		nA
3-State Output Leakage (I _{OZ})	A or B	V _{CC} = 5.0V, V _O = V _{CC} or 0V		Full		±0.1		μA
Quiescent Supply Current (I _{CC})		V _{CC} = 5.0V, V _I = V _{CC} or 0V, I _O = 0		Full		0.1		μA
Power Off Leakage Current (I _{OFF})		V _{CC} = 0V, V _I or V _O = 0V to 5.0V		Full		±0.1		μA
Input Capacitance (C _I)	DIR or $\overline{\text{OE}}$	V _{CC} = 1.8V to 5.0V		+25°C		13		pF

SWITCHING CHARACTERISTICS(Full = -40°C to +125°C, typical values are at T_A = +25°C, unless otherwise noted.)

PARAMETER	FROM (INPUT)	TO (OUTPUT)	V _{CC}	MIN	TYP	MAX	UNITS
(C_L = 50pF)							
t _{PD}	A or B	B or A	1.8V		23		ns
			3.3V		13		
			5.0V		11		
t _{EN}	$\overline{\text{OE}}$	A or B	1.8V		19		ns
			3.3V		12		
			5.0V		10		
t _{DIS}	$\overline{\text{OE}}$	A or B	1.8V		24		ns
			3.3V		20		
			5.0V		18		
(C_L = 150pF)							
t _{PD}	A or B	B or A	1.8V		30		ns
			3.3V		14		
			5.0V		13		
t _{EN}	$\overline{\text{OE}}$	A or B	1.8V		32		ns
			3.3V		13		
			5.0V		11		
t _{DIS}	$\overline{\text{OE}}$	A or B	1.8V		35		ns
			3.3V		31		
			5.0V		29		

SWITCHING CHARACTERISTICS

(Full = -40°C to +125°C, typical values are at T_A = +25°C, unless otherwise noted.)

PARAMETER	CONDITIONS		MIN	TYP	MAX	UNITS
Input/Output Capacitance (C _{IO})				22		pF
Output Rise and Fall Times (t _r , t _f)	C _L = 15pF	V _{CC} = 1.8V		14		ns
		V _{CC} = 3.3V		12		
		V _{CC} = 5V		11		
	C _L = 30pF	V _{CC} = 1.8V		14		
		V _{CC} = 3.3V		12		
		V _{CC} = 5V		11		
	C _L = 50pF	V _{CC} = 1.8V		15		
		V _{CC} = 3.3V		12		
		V _{CC} = 5V		11		
Power Dissipation Capacitance per Transceiver (C _{PD})	No load			75		pF

PARAMETER MEASUREMENT INFORMATION

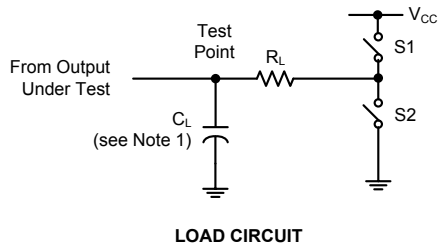

PARAMETER	R_L	C_L	S1	S2
t_{EN}	1k Ω	50pF or 150pF	Open	Closed
			Closed	Open
t_{DIS}	1k Ω	50pF	Open	Closed
			Closed	Open
t_{PD} or t_t	-	50pF or 150pF	Open	Open

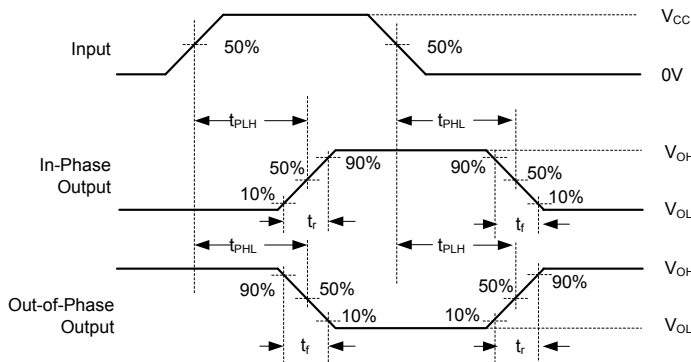

VOLTAGE WAVEFORMS
PROPAGATION DELAY AND OUTPUT TRANSITION TIMES

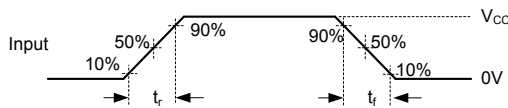

VOLTAGE WAVEFORMS
INPUT RISE AND FALL TIMES

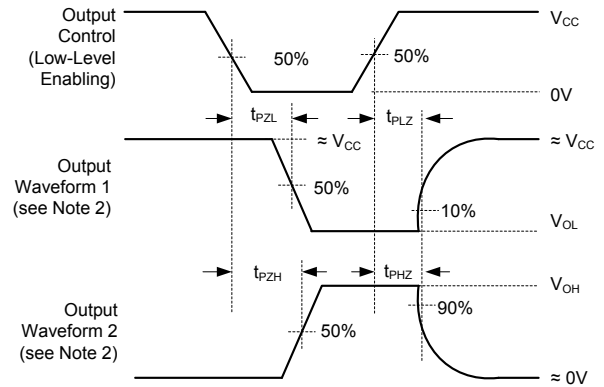

VOLTAGE WAVEFORMS
ENABLE AND DISABLE TIMES FOR 3-STATE OUTPUTS

NOTES:

1. C_L includes probe and test-fixture capacitance.
2. Waveform 1 is for an output with internal conditions such that the output is low except when disabled by the output control. Waveform 2 is for an output with internal conditions such that the output is high except when disabled by the output control.
3. Phase relationships between waveforms were chosen arbitrarily. All input pulses are supplied by generators having the following characteristics: $PRR \leq 1\text{MHz}$, $Z_O = 50\Omega$, $t_r = 6\text{ns}$, $t_f = 6\text{ns}$.
4. The outputs are measured one at a time with one input transition per measurement.
5. t_{PLZ} and t_{PHZ} are the same as t_{DIS} .
6. t_{PZL} and t_{PZH} are the same as t_{EN} .
7. t_{PLH} and t_{PHL} are the same as t_{PD} .

Figure 1. Load Circuit and Voltage Waveforms

PACKAGE INFORMATION

PACKAGE OUTLINE DIMENSIONS

TSSOP-20

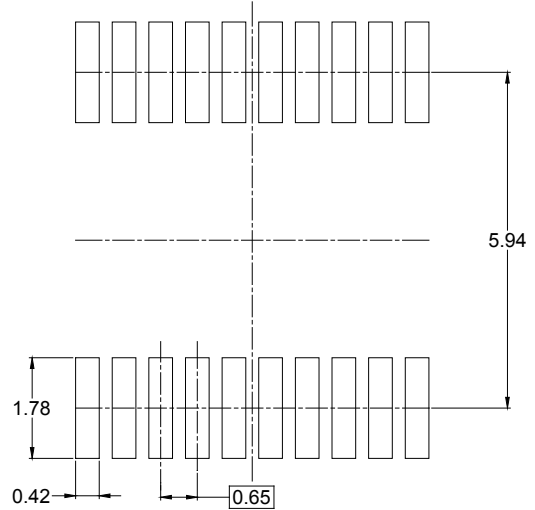
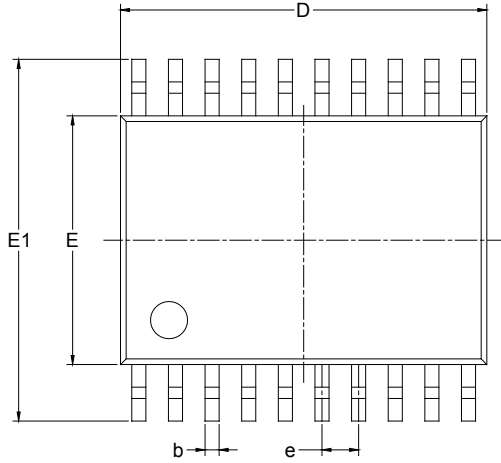

RECOMMENDED LAND PATTERN (Unit: mm)

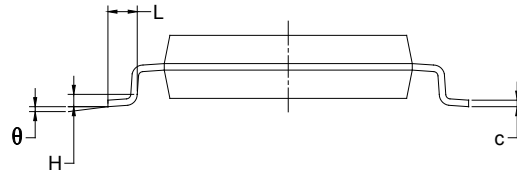
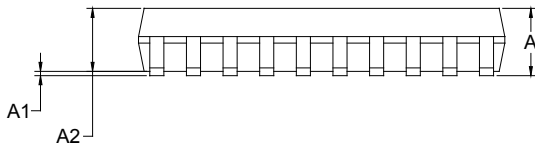

Symbol	Dimensions In Millimeters		Dimensions In Inches	
	MIN	MAX	MIN	MAX
A		1.100		0.043
A1	0.050	0.150	0.002	0.006
A2	0.800	1.000	0.031	0.039
b	0.190	0.300	0.007	0.012
c	0.090	0.200	0.004	0.008
D	6.400	6.600	0.252	0.259
E	4.300	4.500	0.169	0.177
E1	6.250	6.550	0.246	0.258
e	0.650 BSC		0.026 BSC	
L	0.500	0.700	0.02	0.028
H	0.25 TYP		0.01 TYP	
θ	1°	7°	1°	7°

PACKAGE INFORMATION

PACKAGE OUTLINE DIMENSIONS

TQFN-3×3-20L

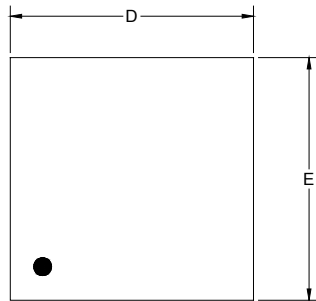

TOP VIEW

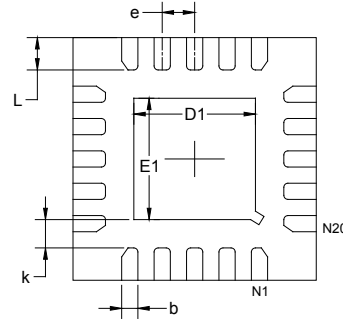

BOTTOM VIEW

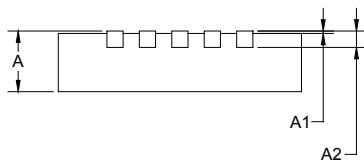

SIDE VIEW

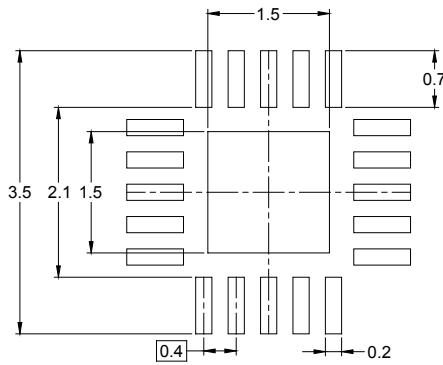

RECOMMENDED LAND PATTERN (Unit: mm)

Symbol	Dimensions In Millimeters		Dimensions In Inches	
	MIN	MAX	MIN	MAX
A	0.700	0.800	0.028	0.031
A1	0.000	0.050	0.000	0.002
A2	0.203 REF		0.008 REF	
D	2.924	3.076	0.115	0.121
D1	1.400	1.600	0.055	0.063
E	2.924	3.076	0.115	0.121
E1	1.400	1.600	0.055	0.063
k	0.200 MIN		0.008 MIN	
b	0.150	0.250	0.006	0.010
e	0.400 TYP		0.016 TYP	
L	0.324	0.476	0.013	0.019

PACKAGE OUTLINE DIMENSIONS

TQFN-5.5×3.5-24L

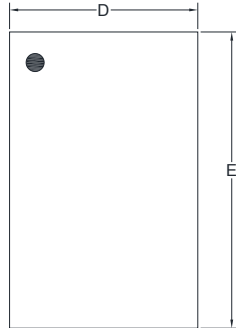

TOP VIEW

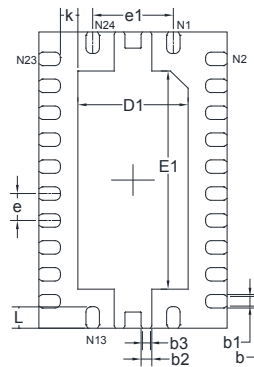

BOTTOM VIEW

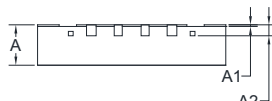

SIDE VIEW

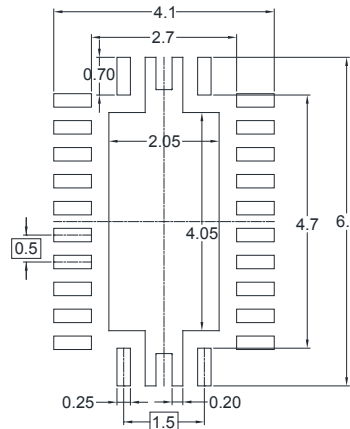

RECOMMENDED LAND PATTERN (Unit: mm)

Symbol	Dimensions In Millimeters		Dimensions In Inches	
	MIN	MAX	MIN	MAX
A	0.700	0.800	0.028	0.031
A1	0.000	0.050	0.000	0.002
A2	0.203 REF		0.008 REF	
D	3.400	3.600	0.134	0.142
D1	1.950	2.150	0.077	0.085
E	5.400	5.600	0.213	0.220
E1	3.950	4.150	0.156	0.163
k	0.325 REF		0.013 REF	
b	0.200	0.300	0.008	0.012
b1	0.180 REF		0.007 REF	
b2	0.150	0.250	0.006	0.010
b3	0.150 REF		0.006 REF	
L	0.300	0.500	0.012	0.020
e	0.500 BSC		0.020 BSC	
e1	1.500 BSC		0.059 BSC	

TAPE AND REEL INFORMATION

REEL DIMENSIONS



TAPE DIMENSIONS

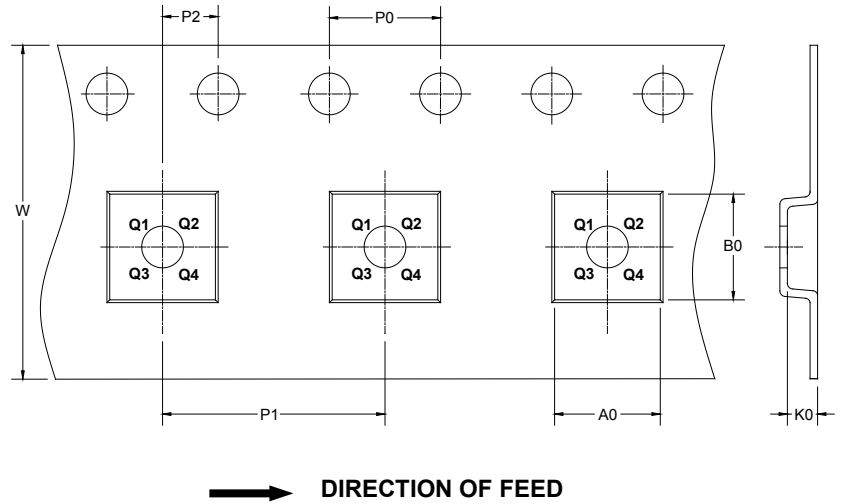

NOTE: The picture is only for reference. Please make the object as the standard.

KEY PARAMETER LIST OF TAPE AND REEL

Package Type	Reel Diameter	Reel Width W1 (mm)	A0 (mm)	B0 (mm)	K0 (mm)	P0 (mm)	P1 (mm)	P2 (mm)	W (mm)	Pin1 Quadrant
TSSOP-20	13"	12.4	6.8	6.85	1.7	4.0	8.0	2.0	12.0	Q1
TQFN-5.5×3.5-24L	13"	12.4	3.8	5.8	1.0	4	8	2	12	Q1
TQFN-3×3-20L	13"	12.4	3.3	3.3	1.1	4.0	4.0	2.0	12.0	Q1

DD0001

PACKAGE INFORMATION

CARTON BOX DIMENSIONS



NOTE: The picture is only for reference. Please make the object as the standard.

KEY PARAMETER LIST OF CARTON BOX

Reel Type	Length (mm)	Width (mm)	Height (mm)	Pizza/Carton
13"	386	280	370	5

DD0002