

# SGM7SZ04

## Small Logic Inverter

### GENERAL DESCRIPTION

The SGM7SZ04 is a single inverter from SGMICRO's Small Logic series. The device is fabricated with advanced CMOS technology to achieve ultra-high speed with high output drive while maintaining low static power dissipation over a broad  $V_{CC}$  operating range. The device is specified to operate over the 1.65V to 5.5V  $V_{CC}$  operating range. The input and output are high impedance when  $V_{CC}$  is 0V. The input tolerates voltages up to 6V, independent of  $V_{CC}$  operating voltage.

The SGM7SZ04 is available in Green UTDFN-1.45×1-6L, SC70-5 and SOT-23-5 packages. It operates over an ambient temperature range of -40°C to +125°C.

### LOGIC SYMBOL

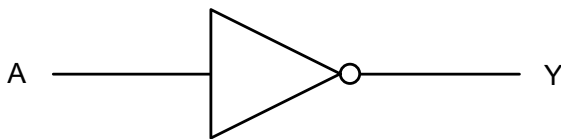

### FEATURES

- **Ultra-High Speed:**  $t_{PD} = 4.2\text{ns}$  (TYP) into 50pF at  $V_{CC} = 3.3\text{V}$
- **High Output Drive:**  $\pm 24\text{mA}$  at  $V_{CC} = 3\text{V}$
- **Broad  $V_{CC}$  Operating Range:** 1.65V to 5.5V
- **Matches Performance of LCX Operated at  $V_{CC} = 3.3\text{V}$**
- **Power Down High-Impedance Input/Output**
- **Over-Voltage Tolerant Input Facilitates 5V to 3V Translation**
- **Available in Green UTDFN-1.45×1-6L, SC70-5 and SOT-23-5 Packages**

### FUNCTION TABLE

INPUT	OUTPUT
A	Y
L	H
H	L

$$Y = \overline{A}$$

H = High Voltage Level

L = Low Voltage Level

**PACKAGE/ORDERING INFORMATION**

MODEL	PACKAGE DESCRIPTION	SPECIFIED TEMPERATURE RANGE	ORDERING NUMBER	PACKAGE MARKING	PACKING OPTION
SGM7SZ04	SC70-5	-40°C to +125°C	SGM7SZ04XC5G/TR	SF3XX	Tape and Reel, 3000
	SOT-23-5	-40°C to +125°C	SGM7SZ04XN5G/TR	SF4XX	Tape and Reel, 3000
	UTDFN-1.45×1-6L	-40°C to +125°C	SGM7SZ04XUDL6G/TR	TCX	Tape and Reel, 5000

**MARKING INFORMATION**

NOTE: X = Date Code. XX = Date Code.

**SC70-5/SOT-23-5**

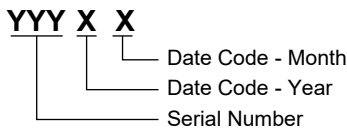

**UTDFN-1.45×1-6L**

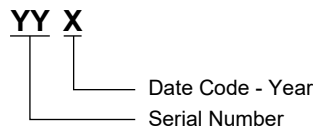

Green (RoHS & HSF): SG Micro Corp defines "Green" to mean Pb-Free (RoHS compatible) and free of halogen substances. If you have additional comments or questions, please contact your SGMICRO representative directly.

**ABSOLUTE MAXIMUM RATINGS**

- Supply Voltage Range,  $V_{CC}$ ..... -0.5V to 6V
- DC Input Voltage Range,  $V_{IN}$ ..... -0.5V to 6V
- DC Output Voltage Range,  $V_{OUT}$ ..... -0.5V to 6V
- DC Input Diode Current,  $I_{IK}$  ( $V_{IN} < -0.5V$ ) ..... -50mA
- DC Output Diode Current,  $I_{OK}$  ( $V_{OUT} < -0.5V$ )..... -50mA
- DC Output Current,  $I_{OUT}$ .....  $\pm 50mA$
- DC  $V_{CC}$  or Ground Current,  $I_{CC}$  or  $I_{GND}$ .....  $\pm 50mA$
- Junction Temperature..... +150°C
- Storage Temperature Range ..... -65°C to +150°C
- Lead Temperature (Soldering, 10s)..... +260°C
- ESD Susceptibility
- HBM..... 8000V
- MM..... 400V

**RECOMMENDED OPERATING CONDITIONS**

- Operating Temperature Range ..... -40°C to +125°C

**OVERSTRESS CAUTION**

Stresses beyond those listed in Absolute Maximum Ratings may cause permanent damage to the device. Exposure to absolute maximum rating conditions for extended periods may affect reliability. Functional operation of the device at any conditions beyond those indicated in the Recommended Operating Conditions section is not implied.

**ESD SENSITIVITY CAUTION**

This integrated circuit can be damaged if ESD protections are not considered carefully. SGMICRO recommends that all integrated circuits be handled with appropriate precautions. Failure to observe proper handling and installation procedures can cause damage. ESD damage can range from subtle performance degradation to complete device failure. Precision integrated circuits may be more susceptible to damage because even small parametric changes could cause the device not to meet the published specifications.

**DISCLAIMER**

SG Micro Corp reserves the right to make any change in circuit design, or specifications without prior notice.

## PIN CONFIGURATIONS

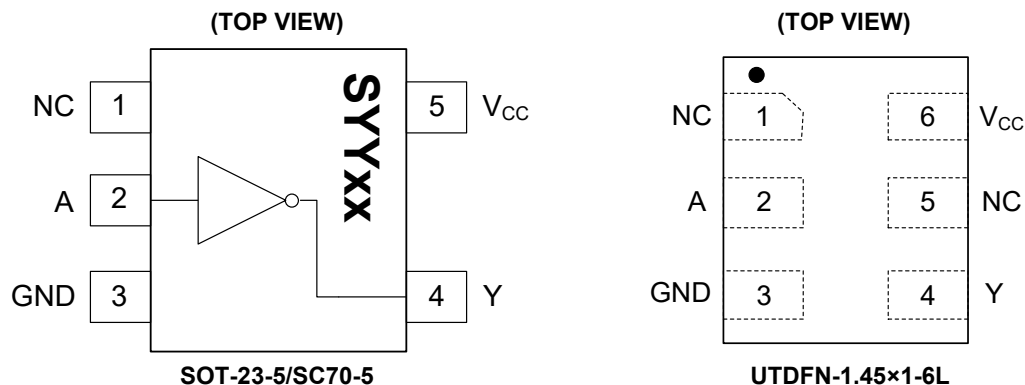

## PIN DESCRIPTION

PIN		NAME	FUNCTION
SOT-23-5/SC70-5	UTDFN-1.45x1-6L		
1	1, 5	NC	No Connection.
2	2	A	Input. Unused input must be held high or low. It may not float.
3	3	GND	Ground.
4	4	Y	Output.
5	6	V <sub>CC</sub>	Power Supply.

**ELECTRICAL CHARACTERISTICS**(Full = -40°C to +125°C, typical values are at  $T_A = +25^\circ\text{C}$ , unless otherwise noted.)

PARAMETER	SYMBOL	CONDITIONS	$V_{CC}$ (V)	MIN	TYP	MAX	UNITS	
<b>General</b>								
Power Supply Range	$V_{CC}$			1.65		5.50	V	
Supply Voltage Data Retention				1.50		5.50		
Input Voltage	$V_{IN}$			0.00		5.50	V	
Output Voltage	$V_{OUT}$			0.00		$V_{CC}$	V	
Input Rise and Fall Times	$t_r, t_f$		1.8, 2.5 ± 0.2	0		20	ns/V	
			3.3 ± 0.3	0		10		
			5.0 ± 0.5	0		5		
<b>DC Performance</b>								
High-Level Input Voltage	$V_{IH}$		1.65 to 5.5	$0.75 \times V_{CC}$			V	
Low-Level Input Voltage	$V_{IL}$		1.65 to 5.5			$0.20 \times V_{CC}$	V	
High-Level Output Voltage	$V_{OH}$	$V_{IN} = V_{IL}$	$I_{OH} = -100\mu\text{A}$	1.65	1.62	1.65	V	
				1.80	1.77	1.80		
				2.30	2.27	2.30		
				3.00	2.97	3.00		
				4.50	4.47	4.50		
			$I_{OH} = -4\text{mA}$	1.65	1.46	1.55		
			$I_{OH} = -8\text{mA}$	2.30	2.01	2.18		
			$I_{OH} = -16\text{mA}$	3.00	2.49	2.81		
			$I_{OH} = -24\text{mA}$	3.00	2.30	2.70		
Low-Level Output Voltage	$V_{OL}$	$V_{IN} = V_{IH}$	$I_{OL} = 100\mu\text{A}$	1.65		0.00	0.02	
				1.80		0.00	0.02	
				2.30		0.00	0.02	
				3.00		0.00	0.02	
				4.50		0.00	0.02	
			$I_{OL} = 4\text{mA}$	1.65		0.06	0.12	
			$I_{OL} = 8\text{mA}$	2.30		0.09	0.18	
			$I_{OL} = 16\text{mA}$	3.00		0.16	0.33	
			$I_{OL} = 24\text{mA}$	3.00		0.24	0.51	
$I_{OL} = 32\text{mA}$	4.50		0.29	0.58				
Input Leakage Current	$I_{IN}$	$V_{IN} = 5.5\text{V}, \text{GND}$		0 to 5.5		±0.10	±5	μA
Power-Off Leakage Current	$I_{OFF}$	$V_{IN}$ or $V_{OUT} = 5.5\text{V}$		0		0.10	5	μA
Quiescent Supply Current	$I_{CC}$	$V_{IN} = 5.5\text{V}, \text{GND}$		1.65 to 5.5		0.10	10	μA

**ELECTRICAL CHARACTERISTICS (continued)**(Full = -40°C to +125°C, typical values are at T<sub>A</sub> = +25°C, unless otherwise noted.)

PARAMETER	SYMBOL	CONDITIONS	MIN	TYP	MAX	UNITS
<b>AC Performance</b>						
Propagation Delay	t <sub>PHL</sub> , t <sub>PLH</sub>	V <sub>CC</sub> = 1.65V	C <sub>L</sub> = 15pF, R <sub>L</sub> = 1MΩ, Figure 1, Figure 2		9.6	ns
		V <sub>CC</sub> = 1.80V			7.9	
		V <sub>CC</sub> = 2.50V ± 0.20V			4.9	
		V <sub>CC</sub> = 3.30V ± 0.30V			3.7	
		V <sub>CC</sub> = 5.00V ± 0.50V			2.8	
		V <sub>CC</sub> = 3.30V ± 0.30V		C <sub>L</sub> = 50pF, R <sub>L</sub> = 500Ω, Figure 1, Figure 2		
		V <sub>CC</sub> = 5.00V ± 0.50V			3.2	
Input Capacitance	C <sub>IN</sub>	V <sub>CC</sub> = 0V		4.0		pF
Power Dissipation Capacitance <sup>(2)</sup>	C <sub>PD</sub>	V <sub>CC</sub> = 3.30V	Figure 3		16.0	pF
		V <sub>CC</sub> = 5.00V			19.0	

## NOTES:

- Unused input must be held high or low. It may not float.
- C<sub>PD</sub> is defined as the value of the internal equivalent capacitance which is derived from dynamic operating current consumption (I<sub>CCD</sub>) at no output loading and operating at 50% duty cycle (see Figure 3). C<sub>PD</sub> is related to dynamic operating current I<sub>CCD</sub> by the expression: I<sub>CCD</sub> = (C<sub>PD</sub>) (V<sub>CC</sub>) (f<sub>IN</sub>) + (I<sub>CC,Static</sub>).

TEST CIRCUITS

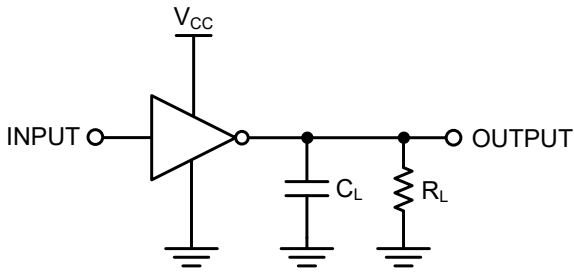

$C_L$  includes load and stray capacitance;  
Input PRR = 1.0MHz;  $t_w$  = 500ns.

Figure 1. AC Test Circuit

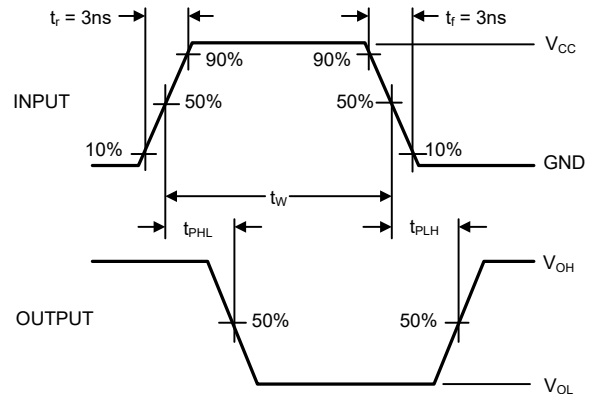
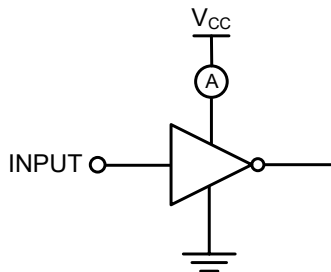

Figure 2. AC Waveforms



Input = AC Waveform;  $t_r = t_f = 1.8ns$ ;  
PRR = 10MHz; Duty Cycle = 50%.

Figure 3.  $I_{CCD}$  Test Circuit

REVISION HISTORY

NOTE: Page numbers for previous revisions may differ from page numbers in the current version.

SEPTEMBER 2021 – REV.A.2 to REV.A.3	Page
Updated Package Outline Dimensions section .....	8, 9
FEBRUARY 2021 – REV.A.1 to REV.A.2	Page
Changed operating temperature range .....	All
APRIL 2014 – REV.A to REV.A.1	Page
Added UTDFN-1.45x1-6L package.....	All
Changes from Original (OCTOBER 2013) to REV.A	Page
Changed from product preview to production data.....	All

# PACKAGE INFORMATION

## PACKAGE OUTLINE DIMENSIONS

### SOT-23-5

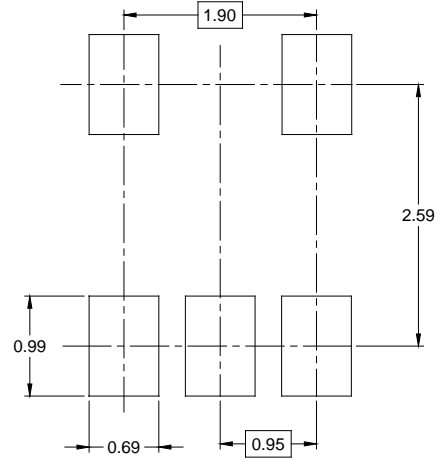
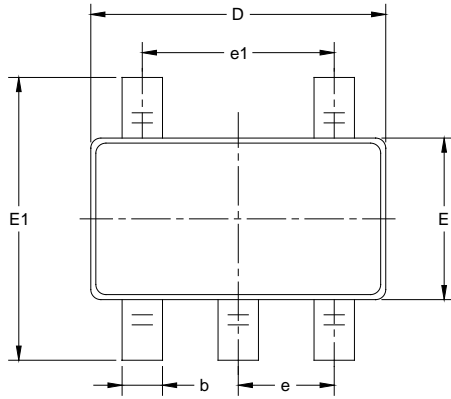

RECOMMENDED LAND PATTERN (Unit: mm)

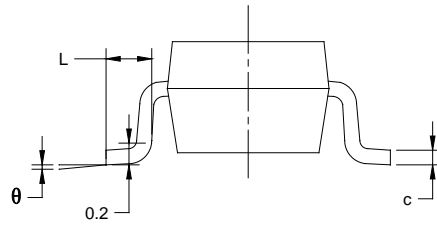
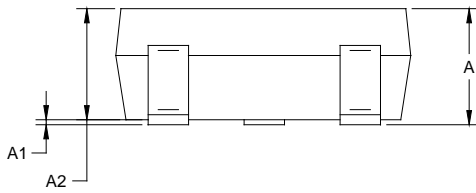

Symbol	Dimensions In Millimeters		Dimensions In Inches	
	MIN	MAX	MIN	MAX
A	1.050	1.250	0.041	0.049
A1	0.000	0.100	0.000	0.004
A2	1.050	1.150	0.041	0.045
b	0.300	0.500	0.012	0.020
c	0.100	0.200	0.004	0.008
D	2.820	3.020	0.111	0.119
E	1.500	1.700	0.059	0.067
E1	2.650	2.950	0.104	0.116
e	0.950 BSC		0.037 BSC	
e1	1.900 BSC		0.075 BSC	
L	0.300	0.600	0.012	0.024
$\theta$	0°	8°	0°	8°

**NOTES:**

1. Body dimensions do not include mode flash or protrusion.
2. This drawing is subject to change without notice.

PACKAGE OUTLINE DIMENSIONS

SC70-5

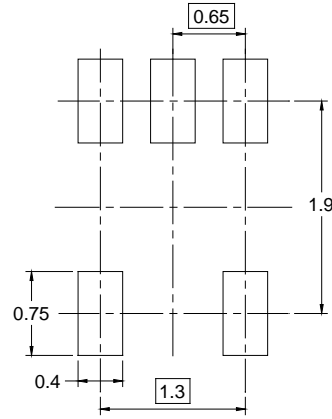

RECOMMENDED LAND PATTERN (Unit: mm)

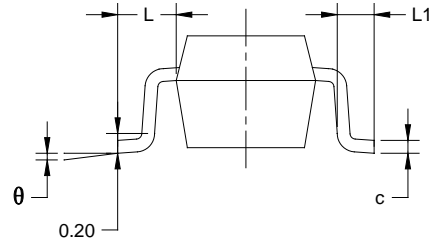
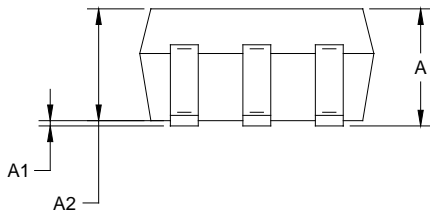

Symbol	Dimensions In Millimeters		Dimensions In Inches	
	MIN	MAX	MIN	MAX
A	0.800	1.100	0.031	0.043
A1	0.000	0.100	0.000	0.004
A2	0.800	1.000	0.031	0.039
b	0.150	0.350	0.006	0.014
c	0.080	0.220	0.003	0.009
D	2.000	2.200	0.079	0.087
E	1.150	1.350	0.045	0.053
E1	2.150	2.450	0.085	0.096
e	0.65 TYP		0.026 TYP	
e1	1.300 BSC		0.051 BSC	
L	0.525 REF		0.021 REF	
L1	0.260	0.460	0.010	0.018
$\theta$	0°	8°	0°	8°

NOTES:

1. Body dimensions do not include mode flash or protrusion.
2. This drawing is subject to change without notice.



# PACKAGE INFORMATION

## PACKAGE OUTLINE DIMENSIONS

### UTDFN-1.45x1-6L

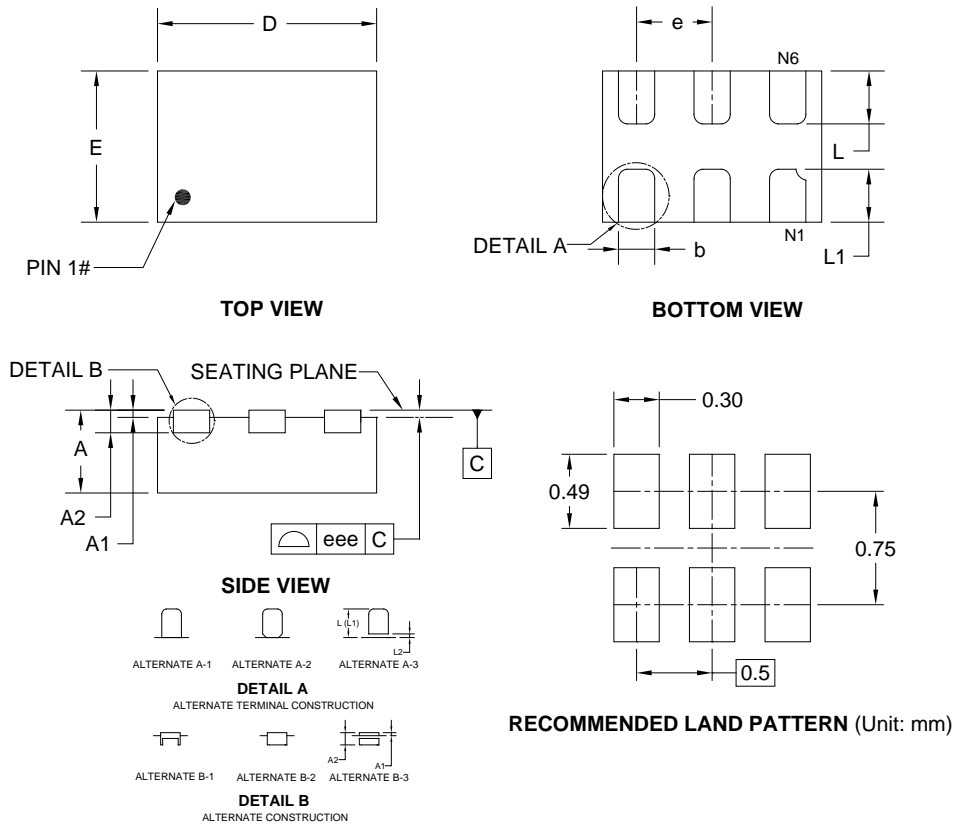

Symbol	Dimensions In Millimeters		Dimensions In Inches	
	MIN	MAX	MIN	MAX
A	0.450	0.600	0.018	0.024
A1	0.000	0.050	0.000	0.002
A2	0.150 REF		0.006 REF	
D	1.374	1.526	0.054	0.060
E	0.924	1.076	0.036	0.042
b	0.150	0.300	0.006	0.012
e	0.500 TYP		0.020 TYP	
eee	0.050		0.002	
L	0.250	0.450	0.010	0.018
L1	0.250	0.500	0.010	0.020
L2	0.000	0.100	0.000	0.004

NOTE: This drawing is subject to change without notice.

# PACKAGE INFORMATION

## TAPE AND REEL INFORMATION

### REEL DIMENSIONS



### TAPE DIMENSIONS



NOTE: The picture is only for reference. Please make the object as the standard.

### KEY PARAMETER LIST OF TAPE AND REEL

Package Type	Reel Diameter	Reel Width W1 (mm)	A0 (mm)	B0 (mm)	K0 (mm)	P0 (mm)	P1 (mm)	P2 (mm)	W (mm)	Pin1 Quadrant
SOT-23-5	7"	9.5	3.20	3.20	1.40	4.0	4.0	2.0	8.0	Q3
SC70-5	7"	9.5	2.25	2.55	1.20	4.0	4.0	2.0	8.0	Q3
UTDFN-1.45×1-6L	7"	9.5	1.15	1.60	0.75	4.0	4.0	2.0	8.0	Q1

DD0001

# PACKAGE INFORMATION

## CARTON BOX DIMENSIONS



NOTE: The picture is only for reference. Please make the object as the standard.

## KEY PARAMETER LIST OF CARTON BOX

Reel Type	Length (mm)	Width (mm)	Height (mm)	Pizza/Carton
7" (Option)	368	227	224	8
7"	442	410	224	18

DD0002