

# SGM8552

## Single-Supply, Dual Rail-to-Rail I/O Precision Operational Amplifier

### GENERAL DESCRIPTION

The SGM8552 is a dual rail-to-rail input and output precision operational amplifier which has low input offset voltage and bias current. It is guaranteed to operate from 2.5V to 5.5V single supply.

The rail-to-rail input and output swings provided by the SGM8552 make both high-side and low-side sensing easy. The combination of characteristics makes the SGM8552 a good choice for temperature, position and pressure sensors, medical equipment and strain gauge amplifiers, or any other 2.5V to 5.5V applications requiring precision and long term stability.

The SGM8552 is specified for the extended industrial/automotive (-40°C to +125°C) temperature range. It is available in Green SOIC-8 and MSOP-8 packages and ESD (HBM) reaches 8kV.

### APPLICATIONS

Temperature Measurements  
Pressure Sensors  
Precision Current Sensings  
Electronic Scales  
Strain Gauge Amplifiers  
Medical Instrumentation  
Thermocouple Amplifiers  
Handheld Test Equipment

### FEATURES

- **Low Offset Voltage: 20 $\mu$ V (MAX)**
- **Rail-to-Rail Input and Output Swing**
- **2.5V to 5.5V Single-Supply Operation**
- **Voltage Gain: 145dB (TYP) at 5V**
- **PSRR: 110dB (TYP)**
- **CMRR: 105dB (TYP)**
- **Ultra Low Input Bias Current: 10pA**
- **Low Supply Current: 930 $\mu$ A (TYP)**
- **Overload Recovery Time: 60 $\mu$ s (at  $V_S = 5V$ )**
- **No External Capacitors Required**
- **-40°C to +125°C Operating Temperature Range**
- **Available in Green SOIC-8 and MSOP-8 Packages**

### PIN CONFIGURATION

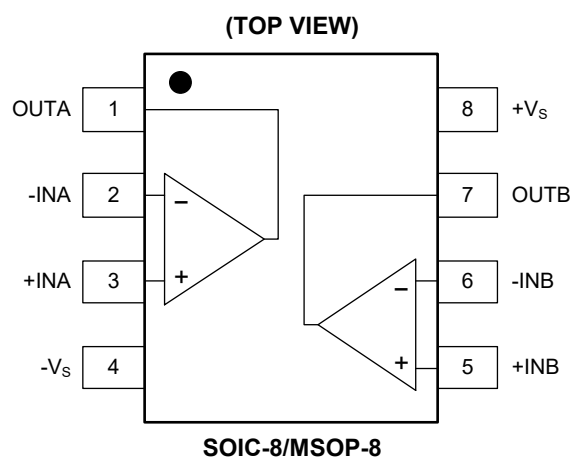

**PACKAGE/ORDERING INFORMATION**

MODEL	PACKAGE DESCRIPTION	SPECIFIED TEMPERATURE RANGE	ORDERING NUMBER	PACKAGE MARKING	PACKING OPTION
SGM8552	SOIC-8	-40°C to +125°C	SGM8552XS8G/TR	SGM8552XS8 XXXXX	Tape and Reel, 2500
	MSOP-8	-40°C to +125°C	SGM8552XMS8G/TR	SGM8552 XMS8 XXXXX	Tape and Reel, 3000

**MARKING INFORMATION**

NOTE: XXXXX = Date Code and Vendor Code.

**SOIC-8/MSOP-8**

**XXXXX**

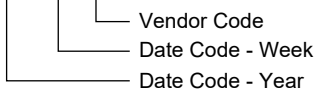

Green (RoHS & HSF): SG Micro Corp defines "Green" to mean Pb-Free (RoHS compatible) and free of halogen substances. If you have additional comments or questions, please contact your SGMICRO representative directly.

**ABSOLUTE MAXIMUM RATINGS**

- Supply Voltage.....6V
- Input Voltage Range .....-V<sub>S</sub> to (+V<sub>S</sub>) + 0.1V
- Differential Input Voltage Range ..... -5V to 5V
- Junction Temperature.....+150°C
- Storage Temperature Range .....-65°C to +150°C
- Lead Temperature (Soldering, 10s).....+260°C
- ESD Susceptibility
- HBM.....8000V
- MM.....400V

**RECOMMENDED OPERATING CONDITIONS**

- Operating Temperature Range .....-40°C to +125°C

**OVERSTRESS CAUTION**

Stresses beyond those listed in Absolute Maximum Ratings may cause permanent damage to the device. Exposure to absolute maximum rating conditions for extended periods

may affect reliability. Functional operation of the device at any conditions beyond those indicated in the Recommended Operating Conditions section is not implied.

**ESD SENSITIVITY CAUTION**

This integrated circuit can be damaged by ESD if you don't pay attention to ESD protection. SGMICRO recommends that all integrated circuits be handled with appropriate precautions. Failure to observe proper handling and installation procedures can cause damage. ESD damage can range from subtle performance degradation to complete device failure. Precision integrated circuits may be more susceptible to damage because very small parametric changes could cause the device not to meet its published specifications.

**DISCLAIMER**

SG Micro Corp reserves the right to make any change in circuit design, or specifications without prior notice.

**ELECTRICAL CHARACTERISTICS**(At  $T_A = +25^\circ\text{C}$ ,  $V_S = 5\text{V}$ ,  $V_{CM} = 2.5\text{V}$ ,  $V_{OUT} = 2.5\text{V}$ , Full =  $-40^\circ\text{C}$  to  $+125^\circ\text{C}$ , unless otherwise noted.)

PARAMETER	CONDITIONS	TEMP	MIN	TYP	MAX	UNITS
<b>Input Characteristics</b>						
Input Offset Voltage ( $V_{OS}$ )		+25°C		4	20	$\mu\text{V}$
		Full			24	
Input Bias Current ( $I_b$ )		+25°C		10		$\text{pA}$
Input Offset Current ( $I_{OS}$ )		+25°C		5		$\text{pA}$
Input Voltage Range		Full	0		5	$\text{V}$
Common Mode Rejection Ratio <sup>(1)</sup> (CMRR)	$V_{CM} = 0\text{V}$ to $5\text{V}$	+25°C	90	105		$\text{dB}$
		Full	83			
Large-Signal Voltage Gain ( $A_{VO}$ )	$R_L = 10\text{k}\Omega$ , $V_{OUT} = 0.3\text{V}$ to $4.7\text{V}$	+25°C	100	145		$\text{dB}$
		Full	97			
Input Offset Voltage Drift ( $\Delta V_{OS}/\Delta T$ )		Full		20		$\text{nV}/^\circ\text{C}$
<b>Output Characteristics</b>						
Output Voltage High ( $V_{OH}$ )	$R_L = 100\text{k}\Omega$ to $-V_S$	+25°C	4.99	4.998		$\text{V}$
		Full	4.987			
	$R_L = 10\text{k}\Omega$ to $-V_S$	+25°C	4.985	4.996		
		Full	4.98			
Output Voltage Low ( $V_{OL}$ )	$R_L = 100\text{k}\Omega$ to $+V_S$	+25°C		2	10	$\text{mV}$
		Full			13	
	$R_L = 10\text{k}\Omega$ to $+V_S$	+25°C		6	15	
		Full			20	
Short-Circuit Limit ( $I_{SC}$ )	$V_{OUT} = 2.5\text{V}$ , $R_L = 10\Omega$ to GND	+25°C	40	48		$\text{mA}$
		Full	23			
<b>Power Supply</b>						
Power Supply Rejection Ratio <sup>(1)</sup> (PSRR)	$V_S = 2.5\text{V}$ to $5.5\text{V}$	+25°C	90	110		$\text{dB}$
		Full	80			
Quiescent Current ( $I_Q$ )	$V_{OUT} = V_S/2$	+25°C		930	1110	$\mu\text{A}$
		Full			1760	
<b>Dynamic Performance</b>						
Gain-Bandwidth Product (GBP)	$A_V = +100$	+25°C		1.53		$\text{MHz}$
Slew Rate (SR)	$A_V = +1$ , $R_L = 10\text{k}\Omega$ , 2V output step	+25°C		0.90		$\text{V}/\mu\text{s}$
Overload Recovery Time	$A_V = -100$ , $R_L = 10\text{k}\Omega$ , $V_{IN} = 200\text{mV}$ (RET to GND)	+25°C		0.06		$\text{ms}$
<b>Noise Performance</b>						
Input Voltage Noise ( $e_{n,P-P}$ )	0.1Hz to 10Hz	+25°C		0.80		$\mu\text{V}_{P-P}$
Input Voltage Noise Density ( $e_n$ )	$f = 1\text{kHz}$	+25°C		47.5		$\text{nV}/\sqrt{\text{Hz}}$

NOTE: 1. PSRR and CMRR are affected by the matching between external gain-setting resistor ratios.

**ELECTRICAL CHARACTERISTICS (continued)**(At  $T_A = +25^\circ\text{C}$ ,  $V_S = 2.5\text{V}$ ,  $V_{CM} = 1.25\text{V}$ ,  $V_{OUT} = 1.25\text{V}$ , Full =  $-40^\circ\text{C}$  to  $+125^\circ\text{C}$ , unless otherwise noted.)

PARAMETER	CONDITIONS	TEMP	MIN	TYP	MAX	UNITS
<b>Input Characteristics</b>						
Input Offset Voltage ( $V_{OS}$ )		+25°C		3	20	$\mu\text{V}$
		Full			24	
Input Bias Current ( $I_b$ )		+25°C		10		$\text{pA}$
Input Offset Current ( $I_{OS}$ )		+25°C		10		$\text{pA}$
Input Voltage Range		Full	0		2.5	$\text{V}$
Common Mode Rejection Ratio <sup>(1)</sup> (CMRR)	$V_{CM} = 0\text{V}$ to $2.5\text{V}$	+25°C	90	105		$\text{dB}$
		Full	81			
Large-Signal Voltage Gain ( $A_{VO}$ )	$R_L = 10\text{k}\Omega$ , $V_{OUT} = 0.3\text{V}$ to $2.4\text{V}$	+25°C	100	135		$\text{dB}$
		Full	94			
Input Offset Voltage Drift ( $\Delta V_{OS}/\Delta T$ )		Full		20		$\text{nV}/^\circ\text{C}$
<b>Output Characteristics</b>						
Output Voltage High ( $V_{OH}$ )	$R_L = 100\text{k}\Omega$ to $-V_S$	+25°C	2.49	2.499		$\text{V}$
		Full	2.488			
	$R_L = 10\text{k}\Omega$ to $-V_S$	+25°C	2.485	2.498		
		Full	2.482			
Output Voltage Low ( $V_{OL}$ )	$R_L = 100\text{k}\Omega$ to $+V_S$	+25°C		1	10	$\text{mV}$
		Full			12	
	$R_L = 10\text{k}\Omega$ to $+V_S$	+25°C		3	15	
		Full			18	
Short-Circuit Limit ( $I_{SC}$ )	$V_{OUT} = 1.25\text{V}$ , $R_L = 10\Omega$ to GND	+25°C	20	28		$\text{mA}$
		Full	15			
<b>Power Supply</b>						
Power Supply Rejection Ratio <sup>(1)</sup> (PSRR)	$V_S = 2.5\text{V}$ to $5.5\text{V}$	+25°C	90	110		$\text{dB}$
		Full	80			
Quiescent Current ( $I_Q$ )	$V_{OUT} = V_S/2$	+25°C		1000	1110	$\mu\text{A}$
		Full			2090	
<b>Dynamic Performance</b>						
Gain-Bandwidth Product (GBP)	$A_V = +100$	+25°C		1.51		$\text{MHz}$
Slew Rate (SR)	$A_V = +1$ , $R_L = 10\text{k}\Omega$ , 2V output step	+25°C		0.90		$\text{V}/\mu\text{s}$
Overload Recovery Time	$A_V = -100$ , $R_L = 10\text{k}\Omega$ , $V_{IN} = 200\text{mV}$ (RET to GND)	+25°C		0.03		$\text{ms}$
<b>Noise Performance</b>						
Input Voltage Noise ( $e_{n\text{P-P}}$ )	0.1Hz to 10Hz	+25°C		0.95		$\mu\text{V}_{\text{P-P}}$
Input Voltage Noise Density ( $e_n$ )	$f = 1\text{kHz}$	+25°C		53		$\text{nV}/\sqrt{\text{Hz}}$

NOTE: 1. PSRR and CMRR are affected by the matching between external gain-setting resistor ratios.

TYPICAL PERFORMANCE CHARACTERISTICS

Large Signal Transient Response at +5V

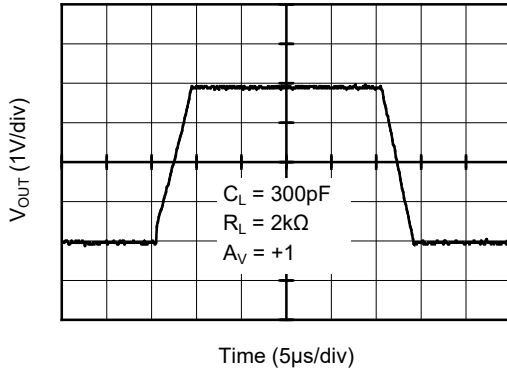

Large Signal Transient Response at +2.5V

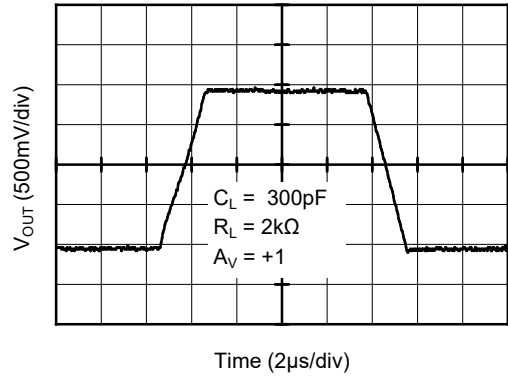

Small Signal Transient Response at +5V

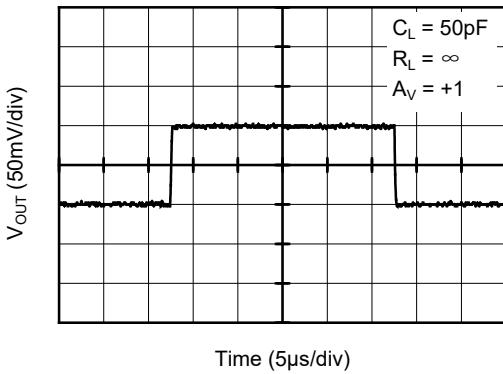

Small Signal Transient Response at +2.5V

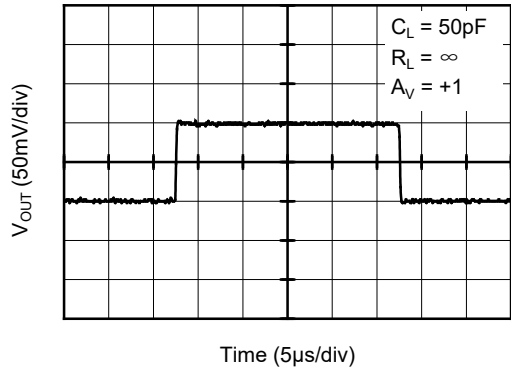

Closed Loop Gain vs. Frequency at +5V

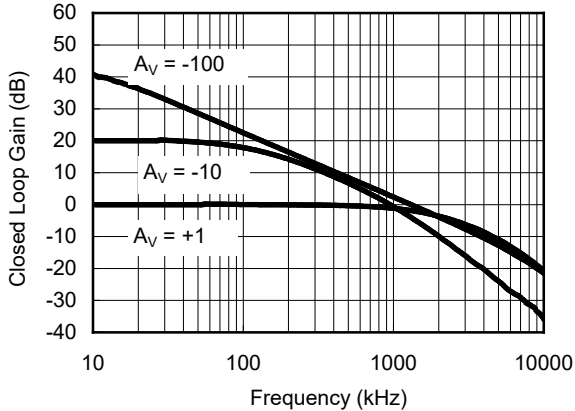

Closed Loop Gain vs. Frequency at +2.5V

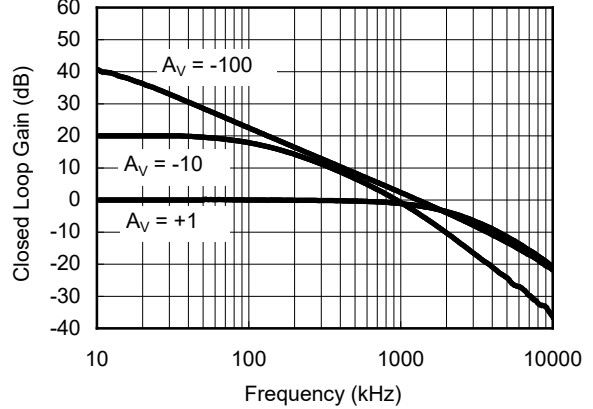

TYPICAL PERFORMANCE CHARACTERISTICS (continued)

Positive Overvoltage Recovery

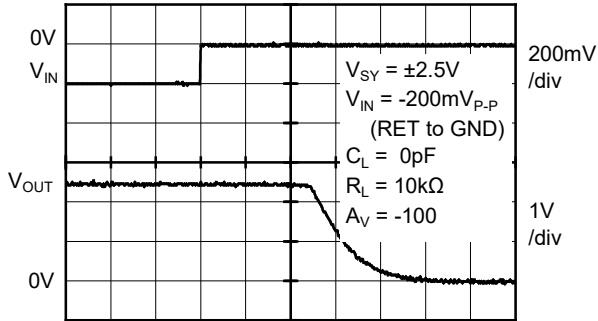

Time (20µs/div)

Negative Overvoltage Recovery

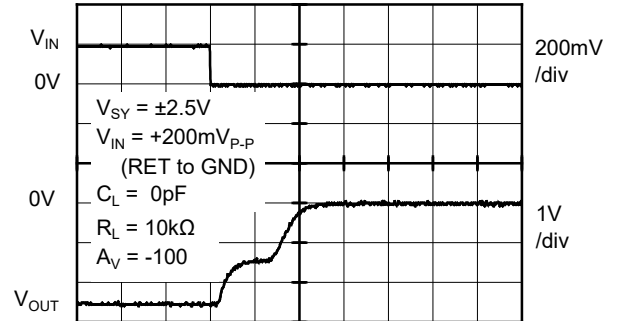

Time (50µs/div)

Open Loop Gain, Phase Shift vs. Frequency at +5V

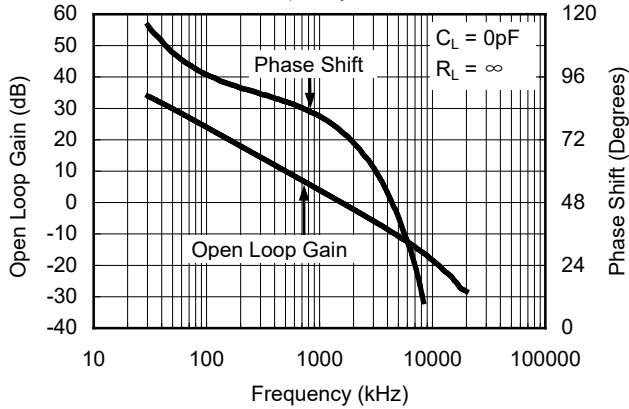

Open Loop Gain, Phase Shift vs. Frequency at +2.5V

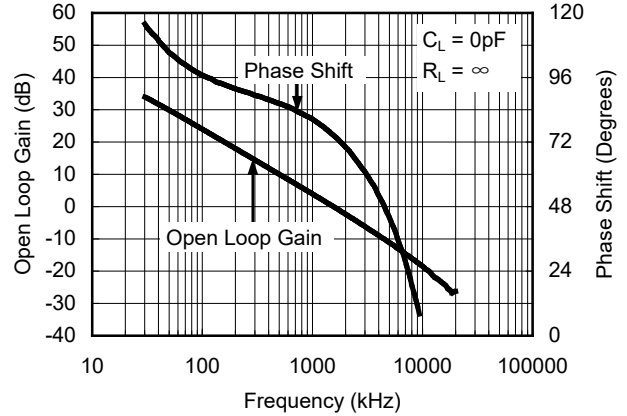

0.1Hz to 10Hz Noise at +5V

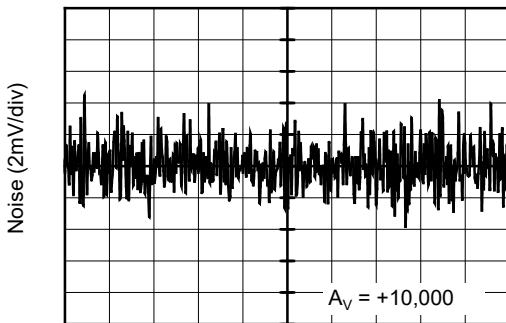

Time (10s/div)

0.1Hz to 10Hz Noise at +2.5V

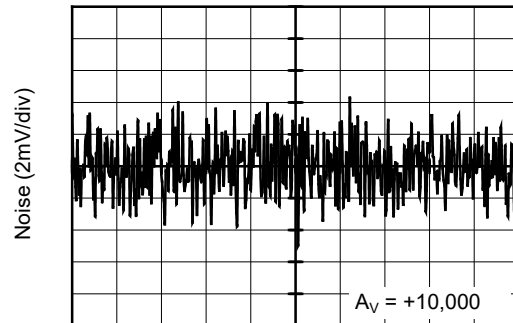

Time (10s/div)

TYPICAL PERFORMANCE CHARACTERISTICS (continued)

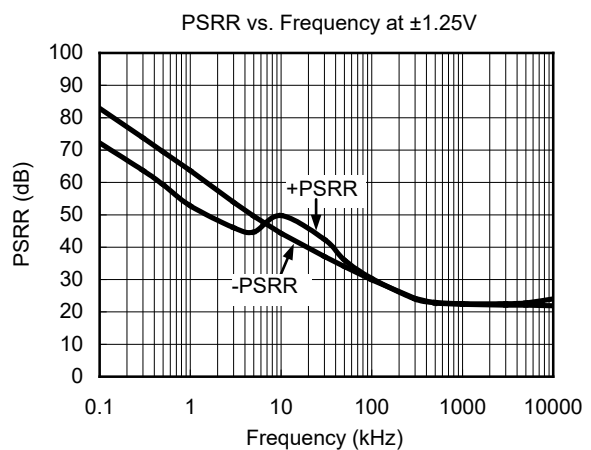
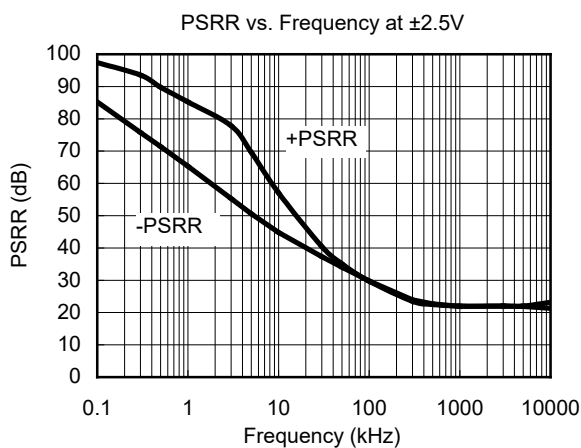
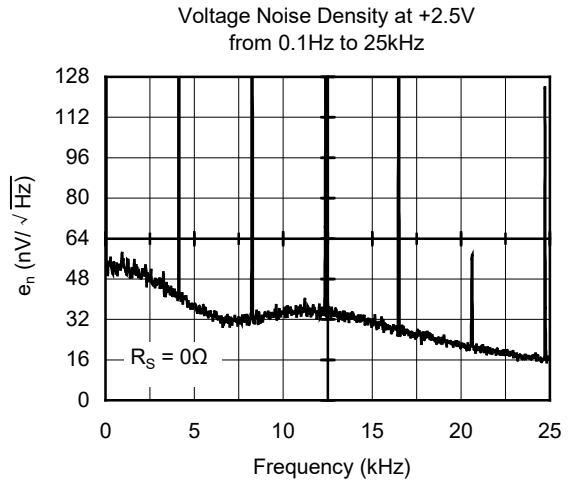
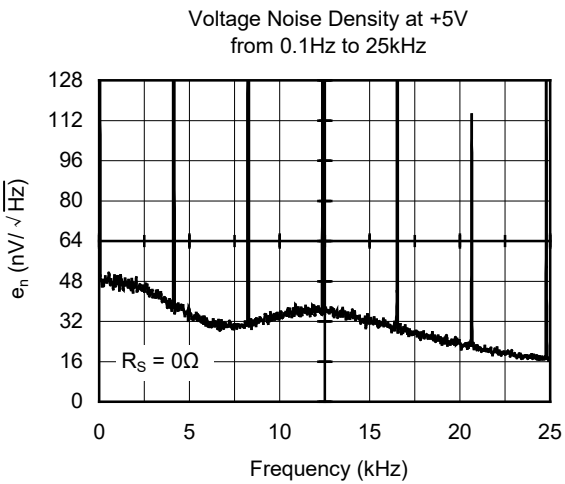
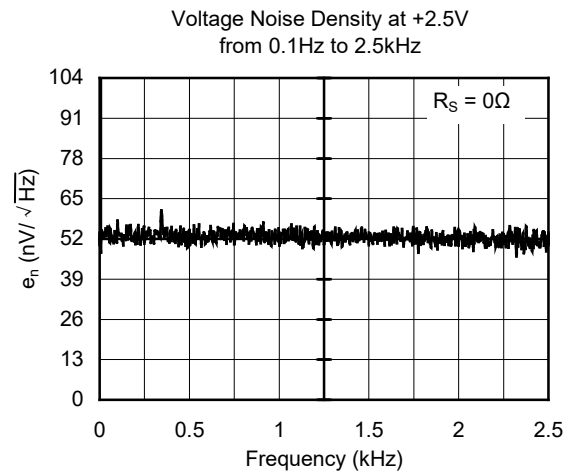
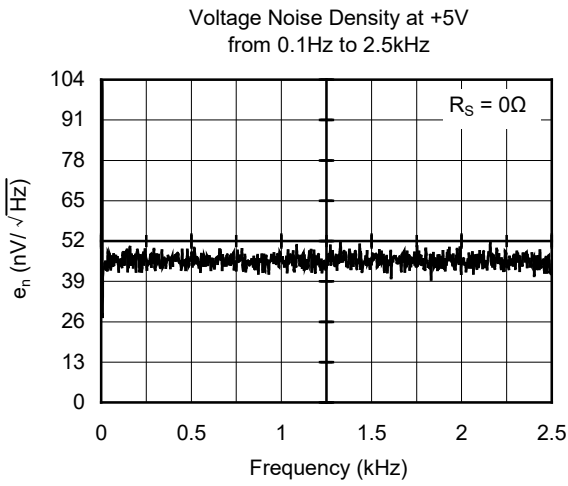

TYPICAL PERFORMANCE CHARACTERISTICS (continued)

CMRR vs. Frequency at +5V

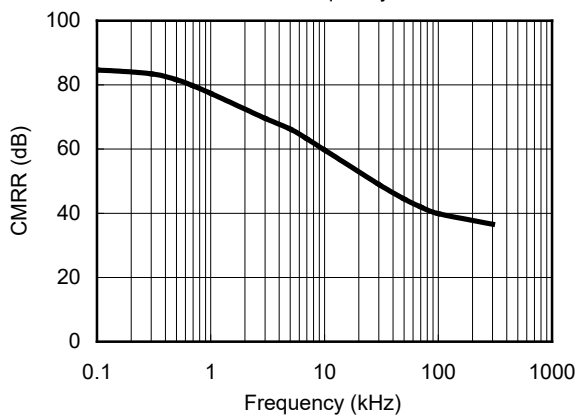

CMRR vs. Frequency at +2.5V

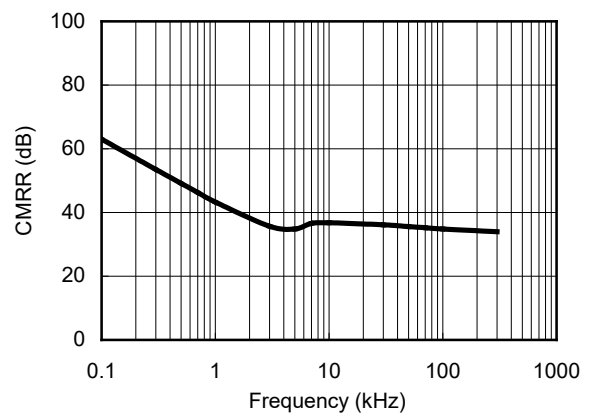

Offset Voltage Production Distribution at +5V

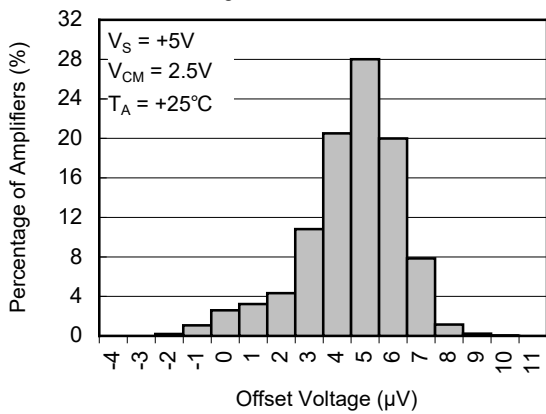

Offset Voltage Production Distribution at +2.5V

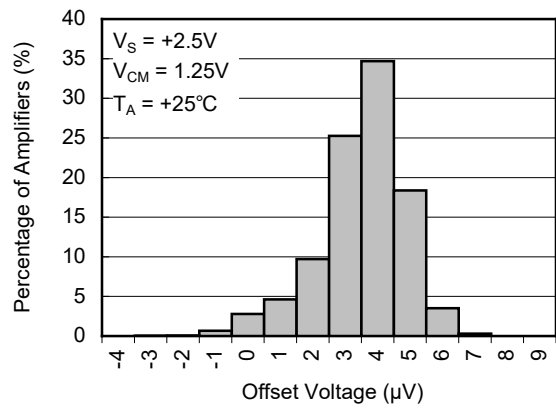



**REVISION HISTORY**

NOTE: Page numbers for previous revisions may differ from page numbers in the current version.

<b>JANUARY 2013 – REV.A.3 to REV.A.4</b>	<b>Page</b>
Added Tape and Reel Information section .....	12, 13

<b>DECEMBER 2011 – REV.A.2 to REV.A.3</b>	<b>Page</b>
Changed Electrical Characteristics section .....	3, 4
Changed Typical Performance Characteristics section .....	7
Changed Package Outline Dimensions section .....	9, 10

<b>MAY 2011 – REV.A.1 to REV.A.2</b>	<b>Page</b>
Changed packages' name .....	All

<b>APRIL 2010 – REV.A to REV.A.1</b>	<b>Page</b>
Changed Typical Performance Characteristics section .....	8

<b>Changes from Original (MARCH 2010) to REV.A</b>	<b>Page</b>
Changed from product preview to production data .....	All

PACKAGE OUTLINE DIMENSIONS

SOIC-8

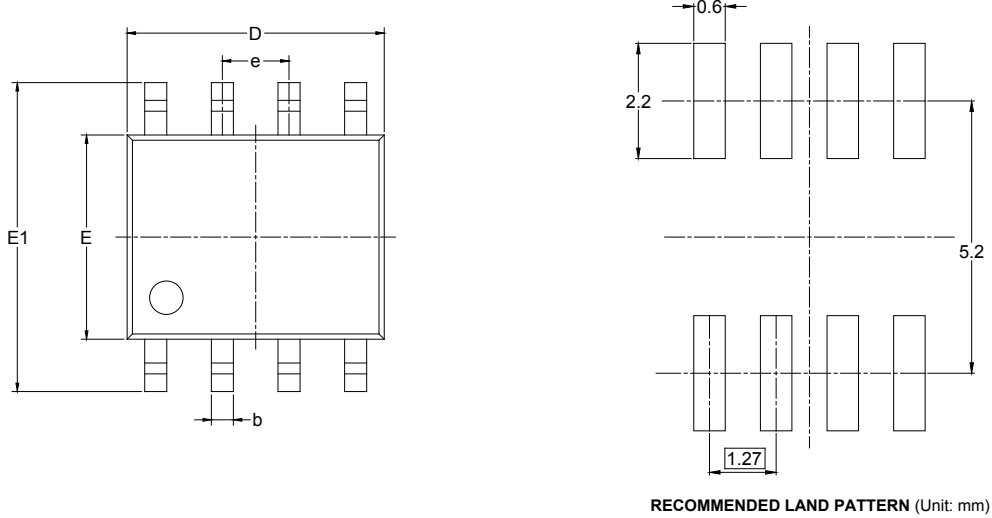

Symbol	Dimensions In Millimeters		Dimensions In Inches	
	MIN	MAX	MIN	MAX
A	1.350	1.750	0.053	0.069
A1	0.100	0.250	0.004	0.010
A2	1.350	1.550	0.053	0.061
b	0.330	0.510	0.013	0.020
c	0.170	0.250	0.006	0.010
D	4.700	5.100	0.185	0.200
E	3.800	4.000	0.150	0.157
E1	5.800	6.200	0.228	0.244
e	1.27 BSC		0.050 BSC	
L	0.400	1.270	0.016	0.050
$\theta$	0°	8°	0°	8°

PACKAGE OUTLINE DIMENSIONS

MSOP-8

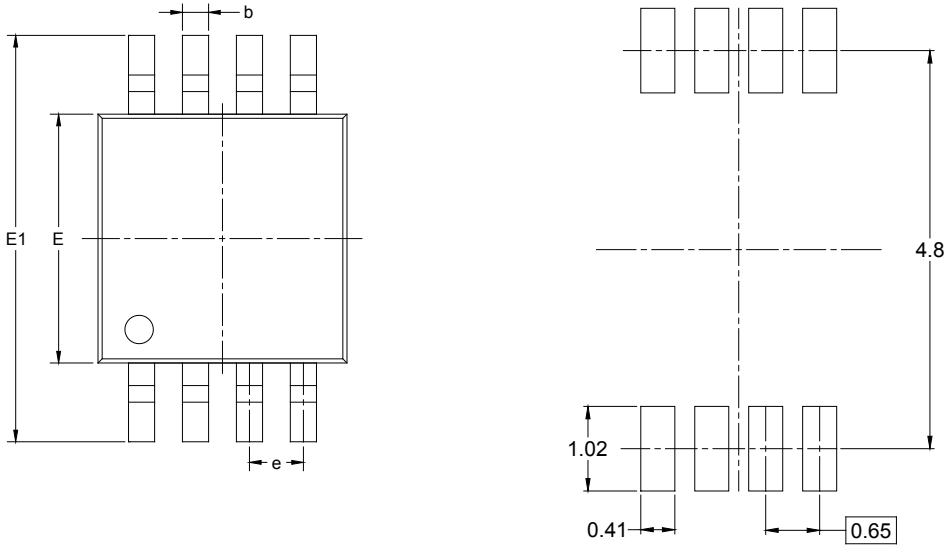

RECOMMENDED LAND PATTERN (Unit: mm)

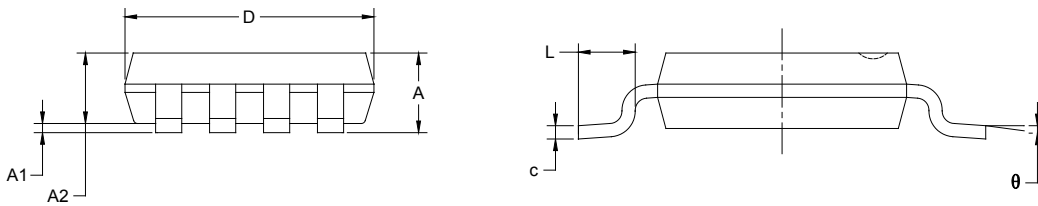

Symbol	Dimensions In Millimeters		Dimensions In Inches	
	MIN	MAX	MIN	MAX
A	0.820	1.100	0.032	0.043
A1	0.020	0.150	0.001	0.006
A2	0.750	0.950	0.030	0.037
b	0.250	0.380	0.010	0.015
c	0.090	0.230	0.004	0.009
D	2.900	3.100	0.114	0.122
E	2.900	3.100	0.114	0.122
E1	4.750	5.050	0.187	0.199
e	0.650 BSC		0.026 BSC	
L	0.400	0.800	0.016	0.031
θ	0°	6°	0°	6°

**TAPE AND REEL INFORMATION**

**REEL DIMENSIONS**

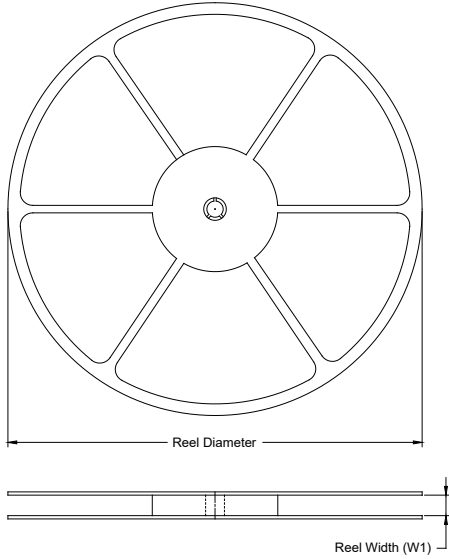

**TAPE DIMENSIONS**

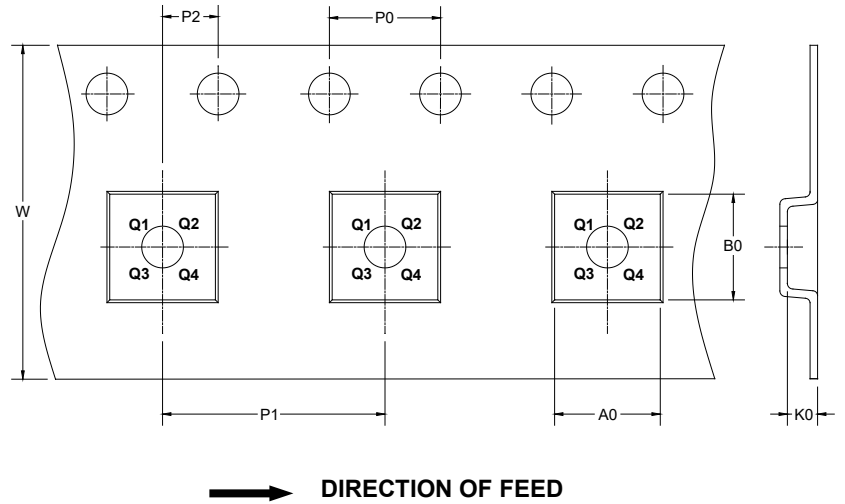

NOTE: The picture is only for reference. Please make the object as the standard.

**KEY PARAMETER LIST OF TAPE AND REEL**

Package Type	Reel Diameter	Reel Width W1 (mm)	A0 (mm)	B0 (mm)	K0 (mm)	P0 (mm)	P1 (mm)	P2 (mm)	W (mm)	Pin1 Quadrant
SOIC-8	13"	12.4	6.40	5.40	2.10	4.0	8.0	2.0	12.0	Q1
MSOP-8	13"	12.4	5.20	3.30	1.50	4.0	8.0	2.0	12.0	Q1

DD0001

# PACKAGE INFORMATION

## CARTON BOX DIMENSIONS

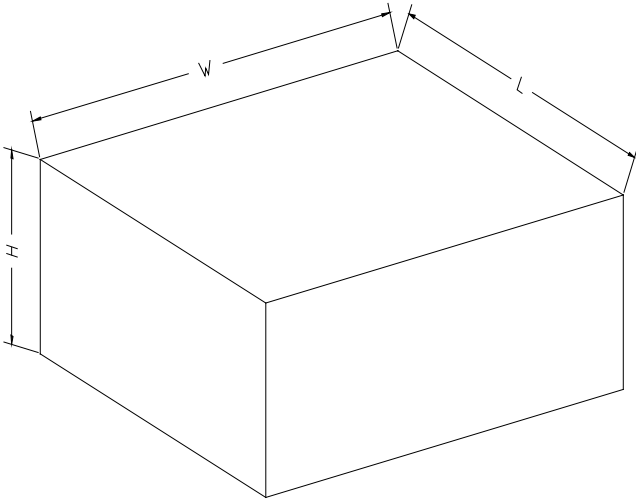

NOTE: The picture is only for reference. Please make the object as the standard.

## KEY PARAMETER LIST OF CARTON BOX

Reel Type	Length (mm)	Width (mm)	Height (mm)	Pizza/Carton
13"	386	280	370	5

DD0002