

GENERAL DESCRIPTION

OB2500N is a high performance offline PSR power switch for low power AC/DC charger and adapter applications. It operates in primary-side sensing and regulation. Consequently, opto-coupler and TL431 could be eliminated. Proprietary Constant Voltage (CV) and Constant Current (CC) control is integrated as shown in the figure below.

In CC control, the current and output power setting can be adjusted externally by the sense resistor R_s at CS pin. In CV control, multi-mode operations are utilized to achieve high performance and high efficiency. In addition, good load regulation is achieved by the built-in cable drop compensation. Device operates in PFM in CC mode at large load condition and it operates in PWM with frequency reduction at light/medium load. The chip consumes very low operation current. It achieves less than 75mW standby power to meet strict standby power standard.

OB2500N offers comprehensive protection coverage with auto-recovery feature including Cycle-by-Cycle current limiting, VDD over voltage protection, feedback loop open protection, short circuit protection, built-in leading edge blanking, VDD under voltage lockout (UVLO), OTP etc.

OB2500N is offered in SOP7 packages.

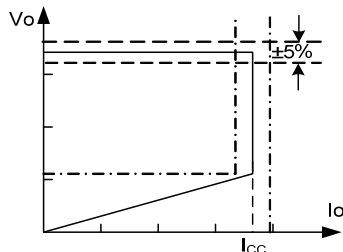
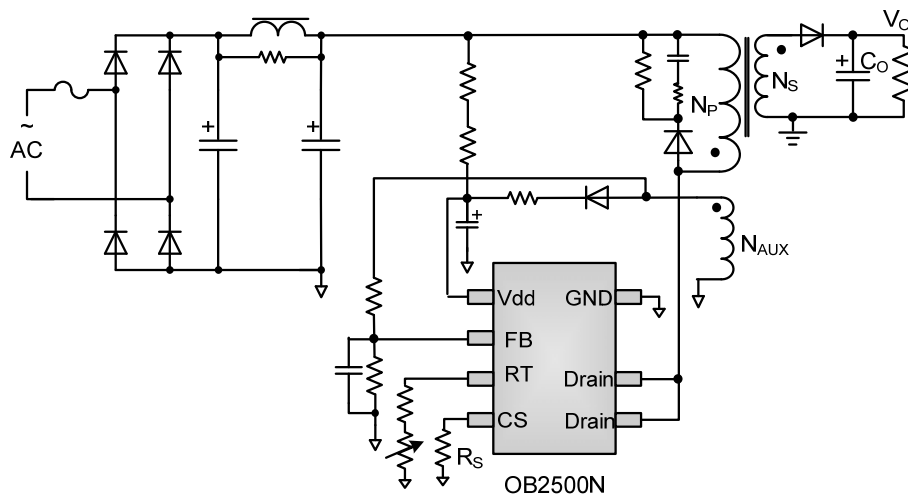

Figure.1. Typical CC/CV Curve

TYPICAL APPLICATION



FEATURES

- Primary-side sensing and regulation without TL431 and opto-coupler
- High precision constant voltage and current regulation at universal AC input
- Multi-mode PWM/PFM operation for efficiency improving
- Integrated 1A 650V MOSFET
- Good dynamic response
- Programmable CV and CC regulation
- Built-in primary winding inductance compensation
- Programmable cable drop compensation
- No need for control loop compensation
- Audio noise free operation
- Built-in leading edge blanking (LEB)
- Ultra low start-up current and low operating current
- Comprehensive protection coverage with auto-recovery
 - On-chip OTP and external OTP
 - VDD over voltage protection
 - VDD under voltage lockout with hysteresis (UVLO)
 - Cycle-by-Cycle current limiting
 - Feedback loop open protection
 - Output short circuit protection

APPLICATIONS

Low Power AC/DC offline SMPS for

- Cell Phone Charger
- Digital Cameras Charger
- Small Power Adapter
- Auxiliary Power for PC, TV etc.
- Linear Regulator/RCC Replacement

OB2500N

High Precision CC/CV Primary-Side Power Switch

GENERAL INFORMATION

Pin Configuration

The pin map is shown as below for SOP7.

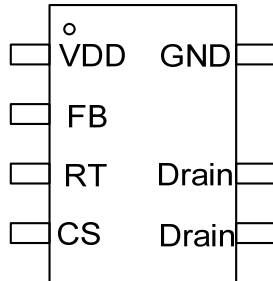

Ordering Information

Part Number	Description
OB2500NCP	SOP7, Pb-free, Tube

Package Dissipation Rating

Package	R θ JA (°C/W)
SOP7	95

Recommended Operating Condition

Symbol	Parameter	Range
VDD	VDD Supply Voltage	8 to 25V

Absolute Maximum Ratings

Parameter	Value
Drain Voltage (off state)	-0.3V to Bvdss
VDD Voltage	-0.3 to 28V
FB Input Voltage	-0.3 to 7V
CS Input Voltage	-0.3 to 7V
Min/Max Operating Junction Temperature T _J	-40 to 150 °C
Operating Temperature T _A Ambient	-40 to 85 °C
Min/Max Storage Temperature T _{stg}	-55 to 150 °C
Lead Temperature (Soldering, 10secs)	260 °C

Note: Stresses beyond those listed under “absolute maximum ratings” may cause permanent damage to the device. These are stress ratings only, functional operation of the device at these or any other conditions beyond those indicated under “recommended operating conditions” is not implied. Exposure to absolute maximum-rated conditions for extended periods may affect device reliability.

Output Power Table

Part Number	90Vac~264Vac
OB2500NCP	6W

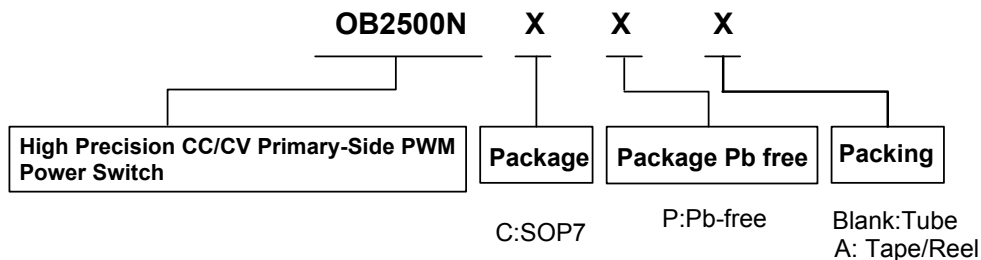

OB2500N

High Precision CC/CV Primary-Side Power Switch

Marking Information

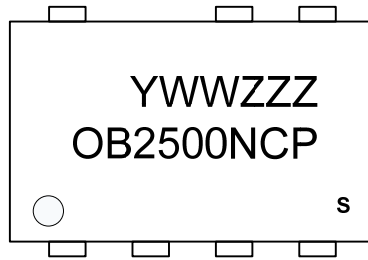

Y:Year Code
WW:Week Code(01-52)
ZZZ:Lot Code
C:SOP7 Package
P:Pb-free Package
S:Internal Code(Optional)

TERMINAL ASSIGNMENTS

Pin Num.	Pin Name	I/O	Description
1	VDD	P	Power Supply
2	FB	I	The voltage feedback from auxiliary winding. Connected to resistor divider from auxiliary winding reflecting output voltage.
3	RT	I	Connected through a NTC resistor to ground for over temperature shutdown
4	CS	I	Power MOSFET source
5/6	Drain	O	Drain of internal power MOSFET
7	GND	P	Ground

OB2500N

High Precision CC/CV Primary-Side Power Switch

BLOCK DIAGRAM

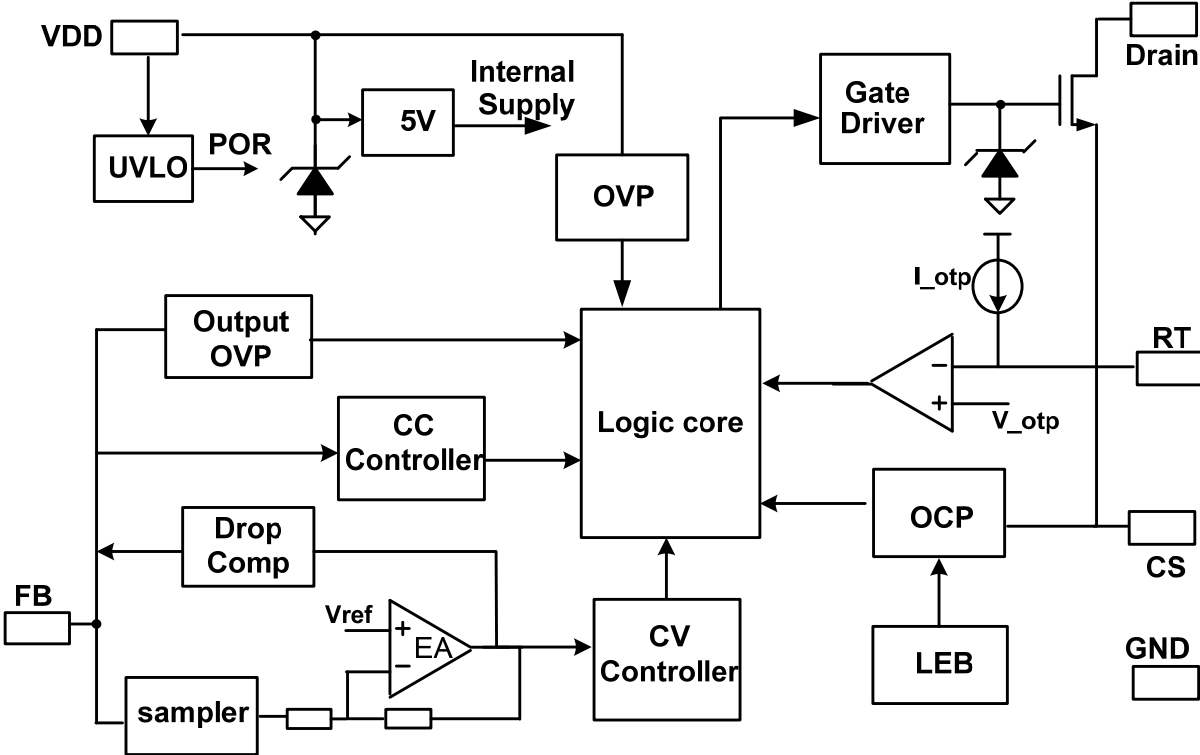

ELECTRICAL CHARACTERISTICS

(TA = 25°C, VDD=15V, if not otherwise noted)

Symbol	Parameter	Test Conditions	Min	Typ.	Max	Unit
Supply Voltage (VDD) Section						
I _{start-up}	Start up current	VDD=UVLO_OFF-1V		5		uA
I _{static}	Static current			0.85	1.0	mA
UVLO(OFF)	VDD under voltage lockout exit		16.0	18.2	20.5	V
UVLO(ON)	VDD under voltage lockout enter		6.5	7.0	7.5	V
VDD_OVP	VDD over voltage protection		26.0	27.0	28.0	V
Max. Operating Voltage					25	V
Current Sense Input Section						
TLEB	LEB time			300		ns
V _{th_ocp_min}	Minimum over current threshold		485	500	515	mV
V _{th_ocp_max}	Maximum over current threshold			590		mV
FB Input Section						
V _{ref_FB}	Reference voltage for feedback threshold		2.475	2.500	2.525	V
T _{pause_min}	Minimum Toff			2.0		us
F _{min}	Minimum frequency		700	780	860	Hz
F _{max}	Maximum frequency		90			KHz
I _{comp_cable}	Maximum cable compensation current		40	45	50	uA
V _{th_cc_shutdown}	CC mode shut down threshold			1.55		V
T _{d_cc_shutdown}	CC mode shut down debounce		1024		2048	cycle
Output Over Voltage Protection						
V _{OVP}	Output Over voltage threshold		2.85	3.0	3.15	V
RT Section						
I _{otp}	RT pin source current			72		uA
V _{otp}	Over temperature trigger voltage			1.0		V
MOSFET Section						
BV _{dss}	Mosfet Drain-Source Breakdown Voltage		650			V
R _{dson}	Static drain to source on resistance			9		Ω

CHARACTERIZATION PLOTS

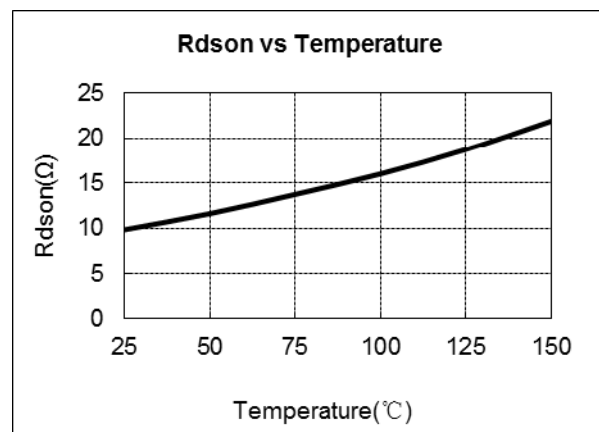
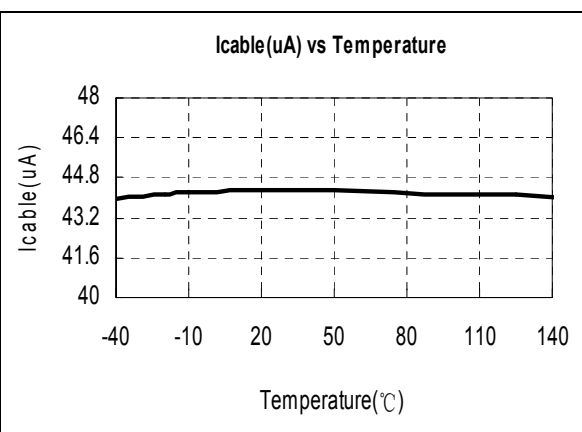
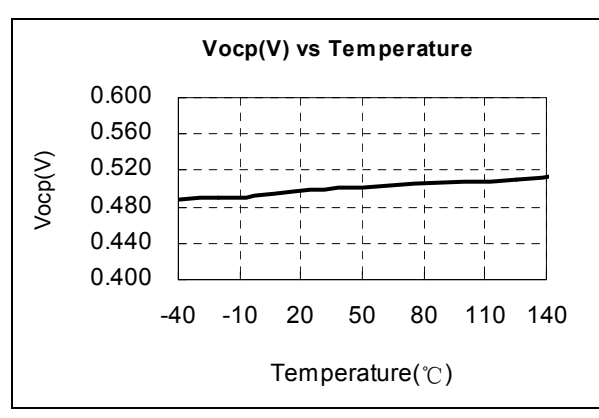
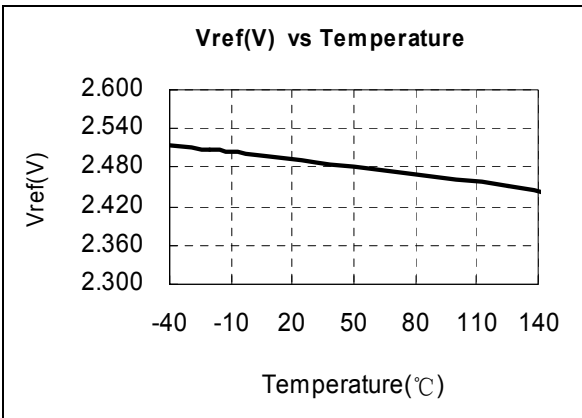
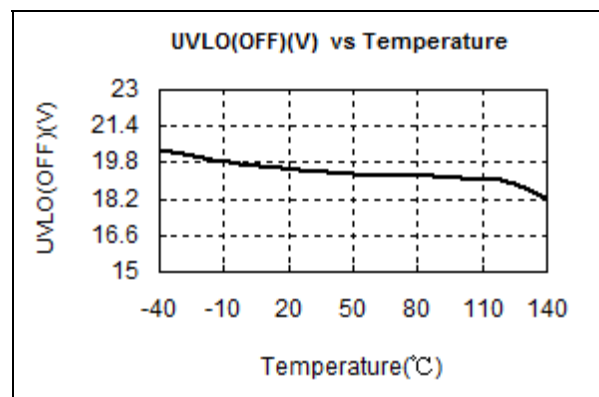
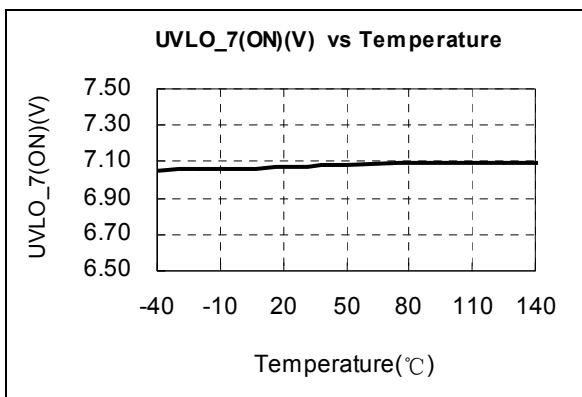
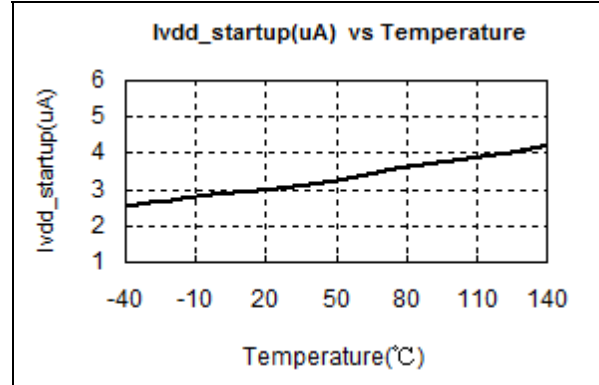
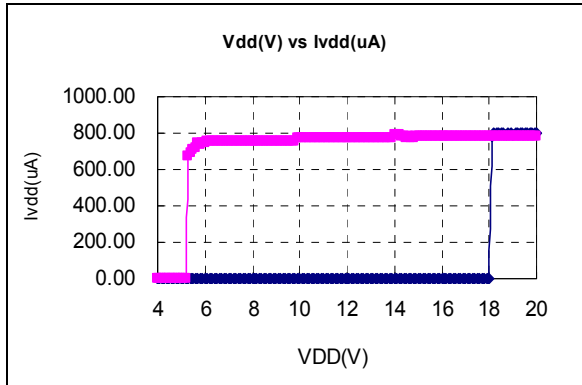

OPERATION DESCRIPTION

OB2500N is a cost effective PSR power switch optimized for off-line low power AC/DC applications including battery chargers. It operates in primary side sensing and regulation, thus opto-coupler and TL431 are not required. Proprietary built-in CV and CC control can achieve high precision CC/CV control meeting most charger application requirements.

Startup Current and Start up Control

Startup current of OB2500N is designed to be very low so that VDD could be charged up above UVLO threshold level and device starts up quickly. A large value startup resistor can therefore be used to minimize the power loss yet achieve a reliable startup in application.

Operating Current

The operating current of OB2500N is as low as 850uA (typical). Good efficiency and less than 75mW standby power is achieved with the low operating current.

CC/CV Operation

OB2500N is designed to produce good CC/CV control characteristic as shown in the Figure. 1.

In charger applications, a discharged battery charging starts in the CC portion of the curve until it is nearly full charged and smoothly switches to operate in CV portion of the curve. The CC portion provides output current limiting. In CV operation, the output voltage is regulated through the primary side control. In CC operation mode, OB2500N will regulate the output current constant regardless of the output voltage drop.

Principle of Operation

To support OB2500N series proprietary CC/CV control, system needs to be designed in DCM mode for flyback system (Refer to Typical Application Diagram in page1).

In the DCM flyback converter, the output voltage can be sensed via the auxiliary winding. During MOSFET turn-on time, the load current is supplied from the output filter capacitor, Co, and the current in the primary winding ramps up. When MOSFET turns off, the energy stored in the primary winding is transferred to the secondary side and the current in the secondary winding is

$$I_S = \frac{N_P}{N_S} \cdot I_P \quad (1)$$

The auxiliary voltage reflects the output voltage as shown in Figure.2 and it is given by

$$V_{AUX} = \frac{N_{AUX}}{N_S} \cdot (V_O + \Delta V) \quad (2)$$

Where ΔV indicates the voltage drop of the

output Diode.

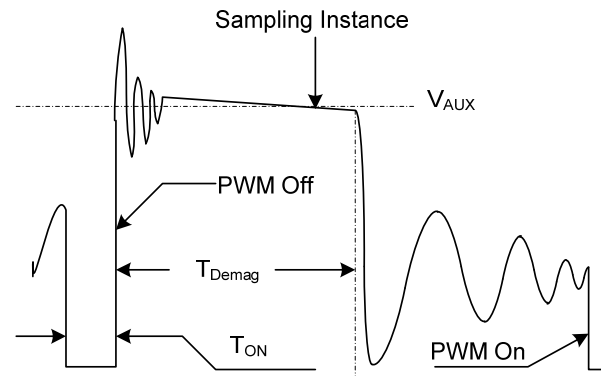

Figure.2. Auxiliary voltage waveform

Via a resistor divider connected between the auxiliary winding and INV (pin 2), the auxiliary voltage is sampled at the middle of the de-magnetization and it is hold until the next sampling. The sampled voltage is compared with reference voltage Vref (typical 2.5V) and the difference is amplified. The error amplifier output reflects the load condition and controls the switching off time to regulate the output voltage, thus constant output voltage can be achieved.

When the sampled voltage is below Vref and the error amplifier output reaches its minimum, the switching frequency is controlled by the sampled voltage to regulate the output current, thus the constant output current can be achieved.

Adjustable CC Point and Output Power

In OB2500N series, the CC point and maximum output power can be externally adjusted by external current sense resistor Rs at CS pin as illustrated in the typical application diagram. The larger Rs, the smaller CC point is, and the smaller output power becomes, and vice versa as shown in Figure.3.

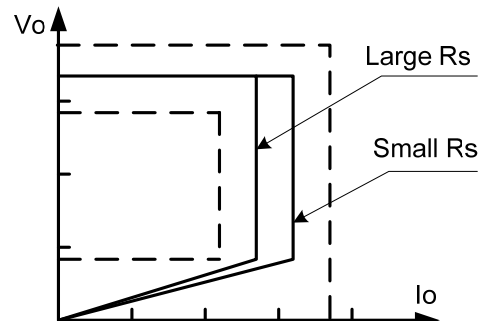

Figure.3. Adjustable output power by changing Rs

Operation Switching Frequency

The switching frequency of OB2500N is adaptively controlled according to the load conditions and the operation modes.

For flyback operating in DCM, the maximum output power is given by

$$P_{O_{MAX}} = \frac{1}{2} L_p F_{SW} I_p^2 \quad (3)$$

Where L_p indicate the inductance of primary winding and I_p is the peak current of primary winding.

Refer to the equation 3, the change of the primary winding inductance results in the change of the maximum output power and the constant output current in CC mode. To compensate the change from variations of primary winding inductance, the switching frequency is locked by an internal loop and the switching frequency is

$$F_{SW} = \frac{1}{2T_{Demag}} \quad (4)$$

Since T_{Demag} is inversely proportional to the inductance, as a result, the product L_p and f_{sw} is constant, thus the maximum output power and constant current in CC mode will not change as primary winding inductance changes. Up to $\pm 7\%$ variation of the primary winding inductance can be compensated.

On Time OCP Compensation

The variation of max output current in CC mode can be rather large if no compensation is provided. The OCP threshold value is self adjusted higher at higher AC voltage. This OCP threshold slope adjustment helps to compensate the increased output current limit at higher AC voltage. In OB2500N, a proprietary OCP compensation block is integrated and no external components are needed. The OCP threshold in OB2500N series is a function of the switching ON time. For the ON time between 1.6us to 6.4us (typical), the OCP threshold changes linearly from 500mV to 590mV. For the ON time larger than 6.4us, the OCP threshold is clamped to 590mV, as shown in Figure 4.

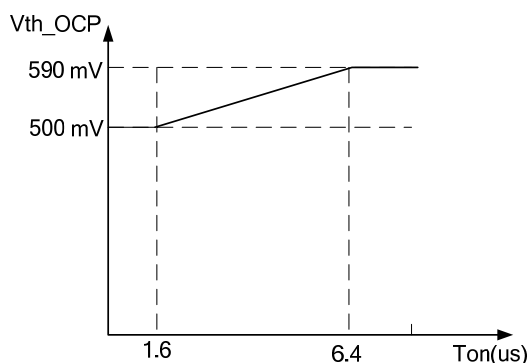

Figure.4. On time OCP compensation

Programmable Cable Drop Compensation

In OB2500N, cable drop compensation is implemented to achieve good load regulation. An offset voltage is generated at INV pin by an

internal current flowing into the resistor divider. The current is proportional to the switching off time, as a result, it is inversely proportional to the output load current, and the drop due to the cable loss can be compensated. As the load current decreases from full-load to no-load, the offset voltage at INV will increase. It can also be programmed by adjusting the resistance of the divider to compensate the drop for various cable lines used.

The percentage of maximum compensation is

$$\frac{\Delta V}{V_{out}} = \frac{I_{comp_cable} \times (R1 // R2) \times 10^{-6}}{2.5} \times 100\%$$

ΔV is load compensation voltage and V_{out} is output voltage;

For example: $R1//R2=6.2Kohm$, the percentage of maximum compensation is

$$\frac{\Delta V}{V_{out}} = \frac{45 \times 6200 \times 10^{-6}}{2.5} \times 100\% = 11.16\%$$

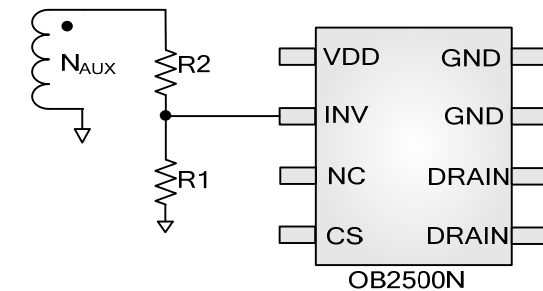

Current Sensing and Leading Edge Blanking

Cycle-by-Cycle current limiting is offered in OB2500N. The switch current is detected by a sense resistor into the CS pin. An internal leading edge blanking circuit chops off the sensed voltage spike at initial power MOSFET on state so that the external RC filtering on sense input is no longer needed.

Gate Driver

The GATE pin is connected to the gate of an external power switch. An internal 11V (typical) clamp is added for MOSFET gate protection at high VCC voltage. When VCC voltage drops below UVLO(ON), the GATE pin is internally pull low to maintain the off state.

CC mode shutdown function

In OB2500N, to prevent the controller operating under abnormal conditions, the minimum output voltage of CC mode is limited to predetermined voltage. The CC output voltage is sampled through FB pin from auxiliary winding at the middle of the de-magnetization. When the FB sampled voltage is below 1.55V and last 1024-2048 cycle, the controller will shut down.

Protection Control

Good power supply system reliability is achieved

OB2500N

High Precision CC/CV Primary-Side Power Switch

with its rich protection features including precise on-chip OTP, cycle-by-cycle current limiting (OCP), output over voltage protection, VDD over voltage protection, short circuit protection, under voltage lockout on VDD (UVLO).

VDD is supplied by transformer auxiliary winding output. The output of OB2500N is shut down when VDD drops below UVLO (ON) and the power converter enters power on start-up sequence there after.

OB2500N

High Precision CC/CV Primary-Side Power Switch

PACKAGE MECHANICAL DATA

SOP7 PACKAGE OUTLINE DIMENSIONS

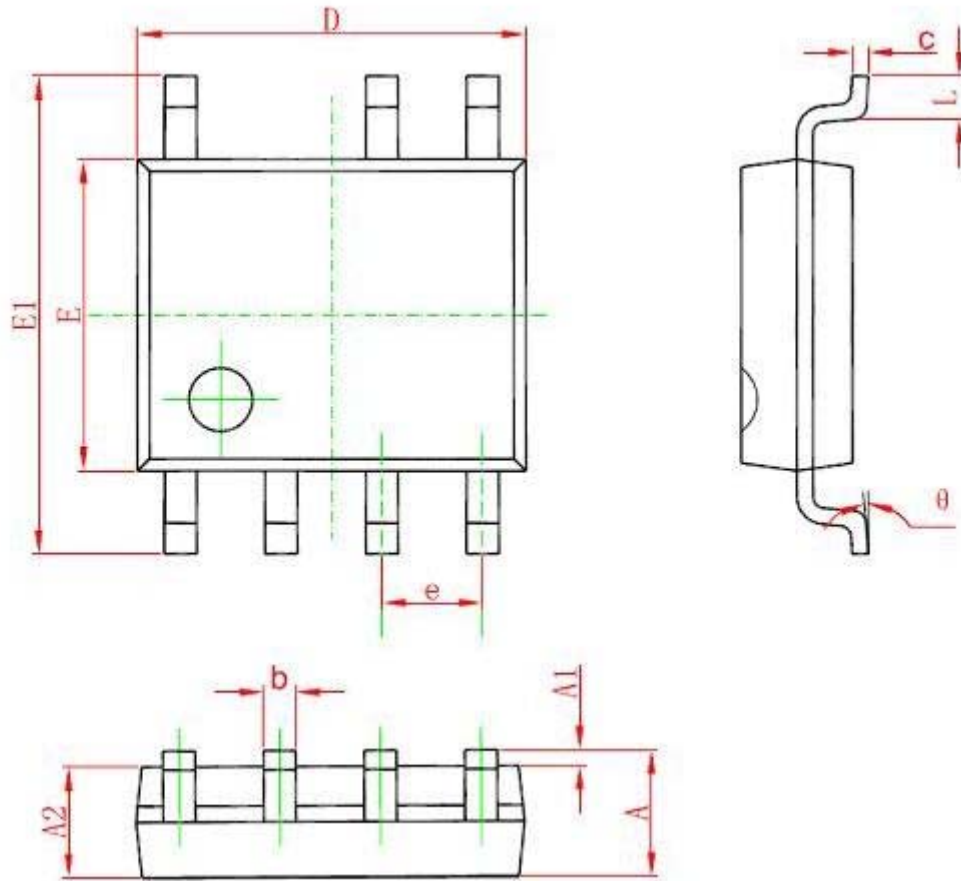

Symbol	Dimensions In Millimeters		Dimensions In Inches	
	Min	Max	Min	Max
A	1.350	1.750	0.053	0.069
A1	0.050	0.250	0.002	0.010
A2	1.250	1.650	0.049	0.065
b	0.310	0.510	0.012	0.020
c	0.100	0.250	0.004	0.010
D	4.700	5.150	0.185	0.203
E	3.800	4.000	0.150	0.157
E1	5.800	6.200	0.228	0.244
e	1.270 (BSC)		0.050 (BSC)	
L	0.400	1.270	0.016	0.050
θ	0°	8°	0°	8°

IMPORTANT NOTICE**RIGHT TO MAKE CHANGES**

On-Bright Electronics Corp. reserves the right to make corrections, modifications, enhancements, improvements and other changes to its products and services at any time and to discontinue any product or service without notice. Customers should obtain the latest relevant information before placing orders and should verify that such information is current and complete.

WARRANTY INFORMATION

On-Bright Electronics Corp. warrants performance of its hardware products to the specifications applicable at the time of sale in accordance with its standard warranty. Testing and other quality control techniques are used to the extent it deems necessary to support this warranty. Except where mandated by government requirements, testing of all parameters of each product is not necessarily performed.

On-Bright Electronics Corp. assumes no liability for application assistance or customer product design. Customers are responsible for their products and applications using On-Bright's components, data sheet and application notes. To minimize the risks associated with customer products and applications, customers should provide adequate design and operating safeguards.

LIFE SUPPORT

On-Bright Electronics Corp.'s products are not designed to be used as components in devices intended to support or sustain human life. On-bright Electronics Corp. will not be held liable for any damages or claims resulting from the use of its products in medical applications.

MILITARY

On-Bright Electronics Corp.'s products are not designed for use in military applications. On-Bright Electronics Corp. will not be held liable for any damages or claims resulting from the use of its products in military applications.