

# SGM2225

## 800mA, High Voltage, Low Noise and Low Dropout Voltage Regulator

### GENERAL DESCRIPTION

The SGM2225 is a high voltage, low noise and low dropout voltage linear regulator. It is capable of supplying 800mA output current with typical dropout voltage of only 450mV. The operating input voltage range is from 3.6V to 36V.

Other features include logic-controlled shutdown mode, short-circuit current limit and thermal shutdown protection. The SGM2225 has automatic discharge function to quickly discharge  $V_{OUT}$  in the disabled status.

The SGM2225 is available in Green SOT-223-3, SOT-89-3, SOIC-8, TDFN-3×3-8L and TO-263-5B packages. It operates over an operating temperature range of -40°C to +125°C.

### FEATURES

- **Wide Operating Input Voltage Range: 3.6V to 36V**
- **Fixed Outputs of 1.8V, 2.5V, 3.3V, 5.0V and 12V**
- **Adjustable Output from 1.8V to 15V**
- **Output Voltage Accuracy:  $\pm 1.5\%$  at +25°C**
- **Low Dropout Voltage: 450mV (TYP) at 800mA**
- **Current Limiting and Thermal Protection**
- **Excellent Load and Line Transient Responses**
- **With Output Automatic Discharge**
- **No-Load Stability**
- **-40°C to +125°C Operating Temperature Range**
- **Available in Green SOT-223-3, SOT-89-3, SOIC-8, TDFN-3×3-8L and TO-263-5B Packages**

### APPLICATIONS

Cellular Telephones  
Palmtop Computers  
High-Efficiency Linear Power Supplies  
Portable Equipment  
Battery-Powered Systems

### TYPICAL APPLICATIONS

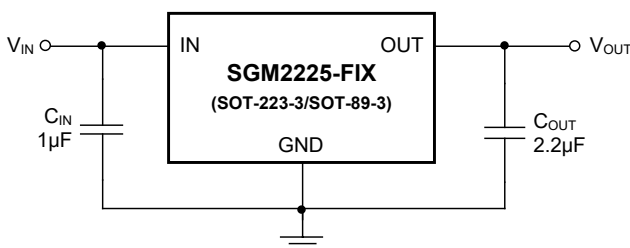

Figure 1. Fixed Voltage Typical Application Circuit

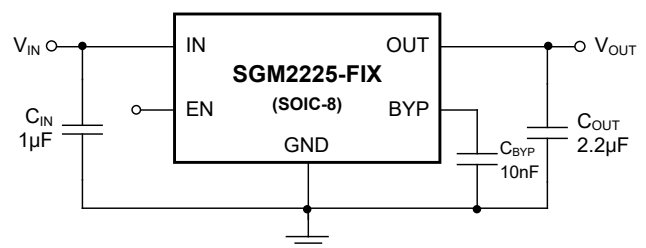

Figure 2. Low Noise Regulator (Fixed Voltage Version)

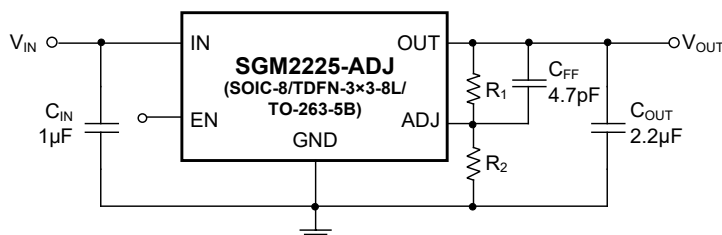

Figure 3. Low Noise Regulator (Adjustable Voltage Version)

## PACKAGE/ORDERING INFORMATION

MODEL	PACKAGE DESCRIPTION	SPECIFIED TEMPERATURE RANGE	ORDERING NUMBER	PACKAGE MARKING	PACKING OPTION
SGM2225-1.8	SOT-89-3	-40°C to +125°C	SGM2225-1.8XK3G/TR	RB8XX	Tape and Reel, 1000
SGM2225-2.5	SOT-89-3	-40°C to +125°C	SGM2225-2.5XK3G/TR	025XX	Tape and Reel, 1000
SGM2225-3.3	SOT-89-3	-40°C to +125°C	SGM2225-3.3XK3G/TR	R8CXX	Tape and Reel, 1000
SGM2225-5.0	SOT-89-3	-40°C to +125°C	SGM2225-5.0XK3G/TR	R8DXX	Tape and Reel, 1000
SGM2225-1.8	SOT-223-3	-40°C to +125°C	SGM2225-1.8XKC3G/TR	RB9 XXXXX	Tape and Reel, 2500
SGM2225-2.5	SOT-223-3	-40°C to +125°C	SGM2225-2.5XKC3G/TR	SWG XXXXX	Tape and Reel, 2500
SGM2225-3.3	SOT-223-3	-40°C to +125°C	SGM2225-3.3XKC3G/TR	R8E XXXXX	Tape and Reel, 2500
SGM2225-5.0	SOT-223-3	-40°C to +125°C	SGM2225-5.0XKC3G/TR	R8F XXXXX	Tape and Reel, 2500
SGM2225-12	SOT-223-3	-40°C to +125°C	SGM2225-12XKC3G/TR	R16 XXXXX	Tape and Reel, 2500
SGM2225-2.5	SOIC-8	-40°C to +125°C	SGM2225-2.5XS8G/TR	SGM 222525XS8 XXXXX	Tape and Reel, 4000
SGM2225-3.3	SOIC-8	-40°C to +125°C	SGM2225-3.3XS8G/TR	SGM R90XS8 XXXXX	Tape and Reel, 4000
SGM2225-5.0	SOIC-8	-40°C to +125°C	SGM2225-5.0XS8G/TR	SGM R91XS8 XXXXX	Tape and Reel, 4000
SGM2225-ADJ	SOIC-8	-40°C to +125°C	SGM2225-ADJXS8G/TR	SGM 2225ADJXS8 XXXXX	Tape and Reel, 4000
SGM2225-1.8	TDFN-3×3-8L	-40°C to +125°C	SGM2225-1.8XTDB8G/TR	SGM SVPDB XXXXX	Tape and Reel, 4000
SGM2225-2.5	TDFN-3×3-8L	-40°C to +125°C	SGM2225-2.5XTDB8G/TR	SGM 026DB XXXXX	Tape and Reel, 4000
SGM2225-3.3	TDFN-3×3-8L	-40°C to +125°C	SGM2225-3.3XTDB8G/TR	SGM R92DB XXXXX	Tape and Reel, 4000
SGM2225-5.0	TDFN-3×3-8L	-40°C to +125°C	SGM2225-5.0XTDB8G/TR	SGM R93DB XXXXX	Tape and Reel, 4000
SGM2225-ADJ	TDFN-3×3-8L	-40°C to +125°C	SGM2225-ADJXTDB8G/TR	SGM R15DB XXXXX	Tape and Reel, 4000

**PACKAGE/ORDERING INFORMATION (continued)**

MODEL	PACKAGE DESCRIPTION	SPECIFIED TEMPERATURE RANGE	ORDERING NUMBER	PACKAGE MARKING	PACKING OPTION
SGM2225-ADJ	TO-263-5B	-40°C to +125°C	SGM2225-ADJXO5G/TR	SGMR94 XO5 XXXXX	Tape and Reel, 800

**MARKING INFORMATION**

NOTE: XX = Date Code. XXXXX = Date Code, Trace Code and Vendor Code.

**SOT-89-3**

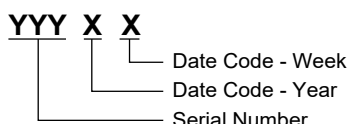

**SOT-223-3/SOIC-8/TDFN-3x3-8L/TO-263-5B**

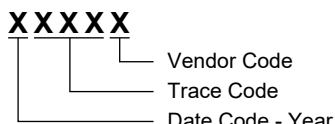

Green (RoHS & HSF): SG Micro Corp defines "Green" to mean Pb-Free (RoHS compatible) and free of halogen substances. If you have additional comments or questions, please contact your SGMICRO representative directly.

**ABSOLUTE MAXIMUM RATINGS**

- Supply Voltage Range,  $V_{IN}$ ..... -40V to +40V
- EN to GND.....-0.3V to  $|V_{IN}| + 0.3V$
- Package Thermal Resistance
- SOT-89-3,  $\theta_{JA}$  .....75°C/W
- SOT-89-3,  $\theta_{JC}$  .....84°C/W
- SOT-223-3,  $\theta_{JA}$  .....95°C/W
- SOT-223-3,  $\theta_{JC}$  .....50°C/W
- SOIC-8,  $\theta_{JA}$  .....95°C/W
- SOIC-8,  $\theta_{JC}$  .....41°C/W
- TDFN-3x3-8L,  $\theta_{JA}$  .....92°C/W
- TDFN-3x3-8L,  $\theta_{JC}$  .....46°C/W
- TO-263-5B,  $\theta_{JA}$  .....45°C/W
- TO-263-5B,  $\theta_{JC}$  .....42°C/W
- Junction Temperature ..... +150°C
- Storage Temperature Range..... -65°C to +150°C
- Lead Temperature (Soldering, 10s)..... +260°C
- ESD Susceptibility
- HBM..... 6000V
- CDM ..... 1000V

**OVERSTRESS CAUTION**

Stresses beyond those listed in Absolute Maximum Ratings may cause permanent damage to the device. Exposure to absolute maximum rating conditions for extended periods may affect reliability. Functional operation of the device at any conditions beyond those indicated in the Recommended Operating Conditions section is not implied.

**ESD SENSITIVITY CAUTION**

This integrated circuit can be damaged if ESD protections are not considered carefully. SGMICRO recommends that all integrated circuits be handled with appropriate precautions. Failure to observe proper handling and installation procedures can cause damage. ESD damage can range from subtle performance degradation to complete device failure. Precision integrated circuits may be more susceptible to damage because even small parametric changes could cause the device not to meet the published specifications.

**RECOMMENDED OPERATING CONDITIONS**

- Input Voltage Range,  $V_{IN}$  .....3.6V to 36V
- Adjustable Output Voltage Range.....1.8V to 15V
- Input Effective Capacitance,  $C_{IN}$  ..... 0.5 $\mu$ F (MIN)
- Output Effective Capacitance,  $C_{OUT}$  ..... 1 $\mu$ F to 10 $\mu$ F
- $C_{BYP}$  Effective Capacitance ..... 10nF
- $C_{FF}$  Effective Capacitance..... 4.7pF
- Operating Junction Temperature Range .....-40°C to +125°C

**DISCLAIMER**

SG Micro Corp reserves the right to make any change in circuit design, or specifications without prior notice.

PIN CONFIGURATIONS

SGM2225-Fixed Output

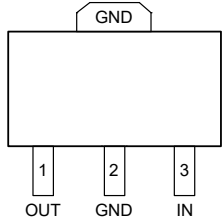

SOT-89-3

SGM2225-Fixed Output

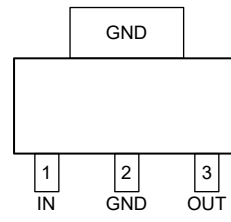

SOT-223-3

SGM2225-Fixed Output

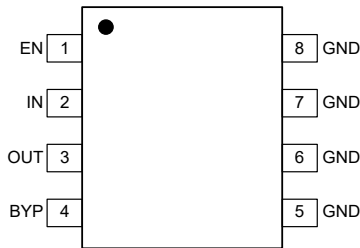

SOIC-8

SGM2225-ADJ

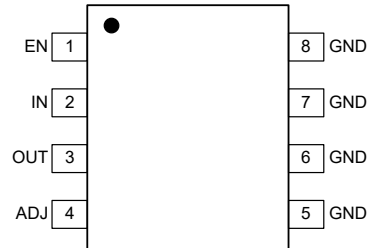

SOIC-8

SGM2225-Fixed Output

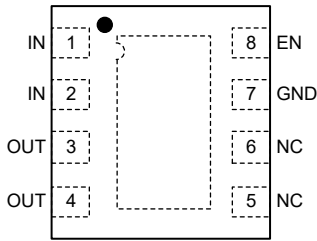

TDFN-3x3-8L

SGM2225-ADJ

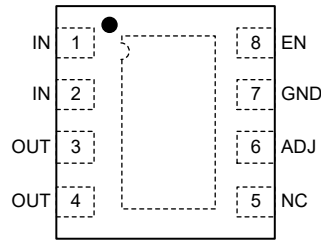

TDFN-3x3-8L

SGM2225-ADJ

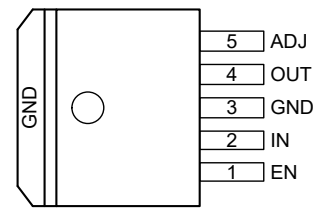

TO-263-5B

PIN DESCRIPTION

PIN					NAME	FUNCTION
SOT-89-3	SOT-223-3	SOIC-8	TDFN-3x3-8L	TO-263-5B		
1	3	3	3, 4	4	OUT	Regulator Output Pin. It is recommended to use an output capacitor with effective capacitance in the range of 1μF to 10μF to ensure stability. Pins 3 and 4 must be tied together for TDFN-3x3-8L package.
2	2	5-8	7	3	GND	Ground. Pins 5 to 8 are internally connected for SOIC-8 package.
3	1	2	1, 2	2	IN	Input Supply Voltage Pin. It is recommended to use a 1μF or larger ceramic capacitor from IN pin to ground to get good power supply decoupling.
-	-	1	8	1	EN	Enable Pin. Drive EN high to turn on the regulator. Drive EN low to turn off the regulator.
-	-	4	-	-	BYP	Reference Bypass Pin (fixed voltage version only). Bypass with an external capacitor C <sub>BYP</sub> can reduce output noise to very low level.
-	-	4	6	5	ADJ	Feedback Voltage Input Pin (adjustable voltage version only). Connect this pin to the midpoint of an external resistor divider to adjust the output voltage. Place the resistors as close as possible to this pin.
-	-	-	5	-	NC	No Connection.
-	-	-	6	-	NC	No Connection (fixed voltage version only).
-	-	-	Exposed Pad	-	GND	Exposed Pad. Exposed pad is internally connected to GND. Connect it to a large ground plane to maximize thermal performance; this pad is not an electrical connection point.

**ELECTRICAL CHARACTERISTICS**

( $V_{IN} = V_{OUT(NOM)} + 1V$ ,  $I_{OUT} = 100\mu A$  and  $C_{OUT} = 2.2\mu F$ ,  $T_J = -40^\circ C$  to  $+125^\circ C$ , typical values are at  $T_J = +25^\circ C$ , unless otherwise noted.)

PARAMETER	SYMBOL	CONDITIONS	MIN	TYP	MAX	UNITS
Input Voltage Range	$V_{IN}$	$T_J = +25^\circ C$	3.6		36	V
Output Voltage Accuracy	$V_{OUT}$	Variation from nominal $V_{OUT}$ , $T_J = +25^\circ C$	-1.5		1.5	%
		Variation from nominal $V_{OUT}$	-2		2	
Reference Voltage	$V_{REF}$	$T_J = +25^\circ C$	1.182	1.2	1.218	V
			1.176		1.224	
Line Regulation	$\frac{\Delta V_{OUT}}{\Delta V_{IN} \times V_{OUT}}$	$V_{IN} = V_{OUT(NOM)} + 1V$ to 36V, $T_J = +25^\circ C$		0.0003	0.003	%V
		$V_{IN} = V_{OUT(NOM)} + 1V$ to 36V			0.005	
Load Regulation	$\frac{\Delta V_{OUT}}{V_{OUT}}$	$I_{OUT} = 100\mu A$ to 800mA, $T_J = +25^\circ C$		0.1	0.3	%
		$I_{OUT} = 100\mu A$ to 800mA			0.4	
Dropout Voltage <sup>(1)</sup>	$V_{DROPO}$	$I_{OUT} = 50mA$ , $T_J = +25^\circ C$		30	38	mV
		$I_{OUT} = 50mA$			55	
		$I_{OUT} = 200mA$ , $T_J = +25^\circ C$		115	150	
		$I_{OUT} = 200mA$			210	
		$I_{OUT} = 800mA$ , $T_J = +25^\circ C$		450	610	
		$I_{OUT} = 800mA$			850	
Output Current Limit	$I_{LIMIT}$	$V_{OUT} = 90\% \times V_{OUT(NOM)}$ , $T_J = +25^\circ C$	820	1100		mA
Short-Circuit Current	$I_{SHORT}$	$V_{IN} = V_{EN} = 3V$ , $V_{OUT} = 0V$		230		mA
Ground Pin Current	$I_Q$	$V_{EN} \geq 1.6V$ , no load, $T_J = +25^\circ C$		80	104	$\mu A$
		$V_{EN} \geq 1.6V$ , no load			112	
		$V_{EN} \geq 1.6V$ , $I_{OUT} = 100\mu A$ , $T_J = +25^\circ C$		80	104	
		$V_{EN} \geq 1.6V$ , $I_{OUT} = 100\mu A$			112	
		$V_{EN} \geq 1.6V$ , $I_{OUT} = 50mA$ , $T_J = +25^\circ C$		220	280	
		$V_{EN} \geq 1.6V$ , $I_{OUT} = 50mA$			290	
		$V_{EN} \geq 1.6V$ , $I_{OUT} = 800mA$ , $T_J = +25^\circ C$		1950	2250	
		$V_{EN} \geq 1.6V$ , $I_{OUT} = 800mA$			2350	
Ground Pin Quiescent Current	$I_{Q(GND)}$	$V_{EN} \leq 0.4V$ (shutdown), $T_J = +25^\circ C$		6.5	8	$\mu A$
		$V_{EN} \leq 0.4V$ (shutdown)			12	
Enable Input Logic-Low Voltage	$V_{ENL}$	$V_{EN} = \text{logic low}$ (regulator shutdown)			0.4	V
		$V_{EN} = \text{logic high}$ (regulator enabled)	1.6			
Enable Input Current	$I_{ENL}$	$V_{ENL} \leq 0.4V$			1	$\mu A$
	$I_{ENH}$	$V_{ENH} \geq 1.6V$			1	
Power Supply Rejection Ratio	PSRR	$f = 1kHz$ , $V_{OUT} = 2.5V$ , $I_{OUT} = 50mA$		75		dB
Output Voltage Noise	$e_n$	$V_{OUT} = 2.5V$ , $I_{OUT} = 50mA$ , $C_{BYP} = 0\mu F$		500		nV/ $\sqrt{Hz}$
Output Voltage Temperature Coefficient	$\frac{\Delta V_{OUT}}{\Delta T_J \times V_{OUT}}$			40		ppm/ $^\circ C$
Thermal Shutdown Temperature	$T_{SHDN}$			155		$^\circ C$
Thermal Shutdown Hysteresis	$\Delta T_{SHDN}$			25		$^\circ C$

## NOTE:

1. The dropout voltage is defined as the difference between  $V_{IN}$  and  $V_{OUT}$  when  $V_{OUT}$  falls to  $95\% \times V_{OUT(NOM)}$ .

TYPICAL PERFORMANCE CHARACTERISTICS

$T_J = +25^\circ\text{C}$ ,  $C_{OUT} = 2.2\mu\text{F}$  and  $I_{OUT} = 100\mu\text{A}$ , unless otherwise noted.

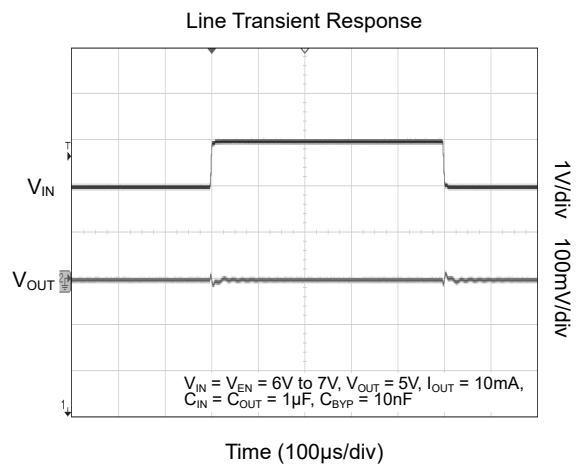
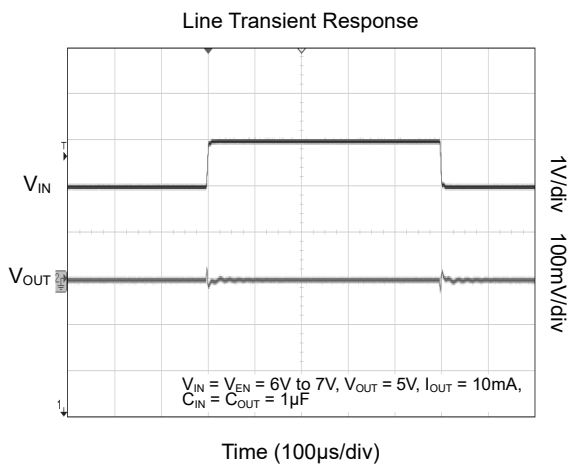
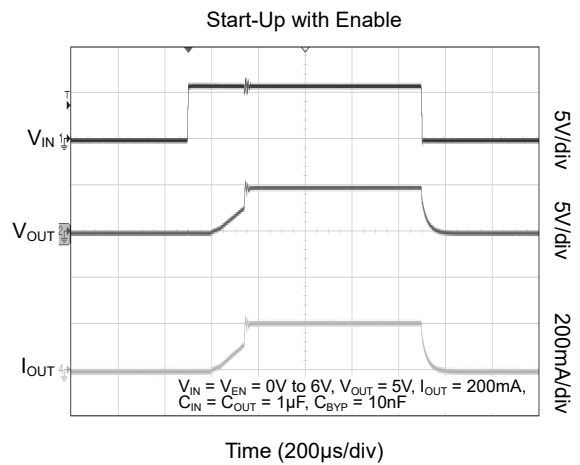
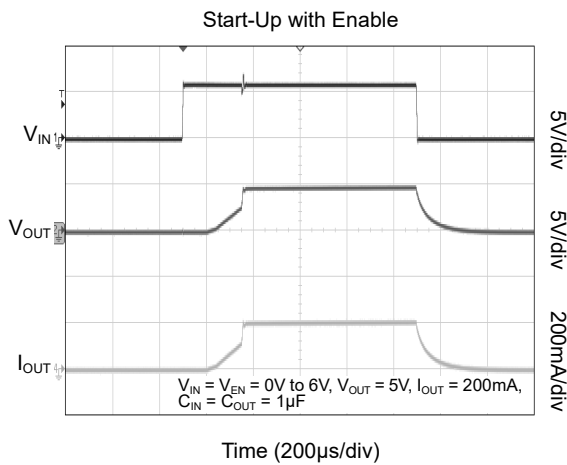
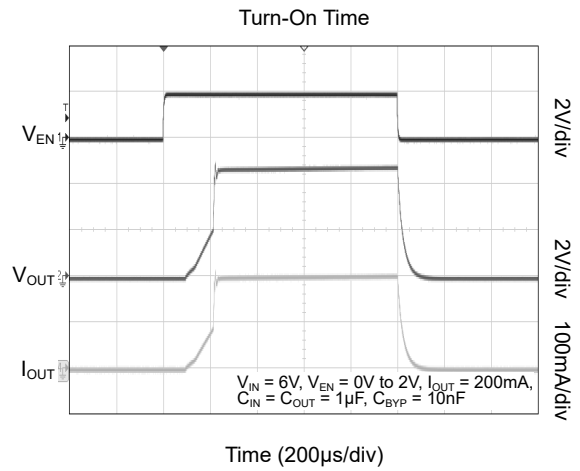
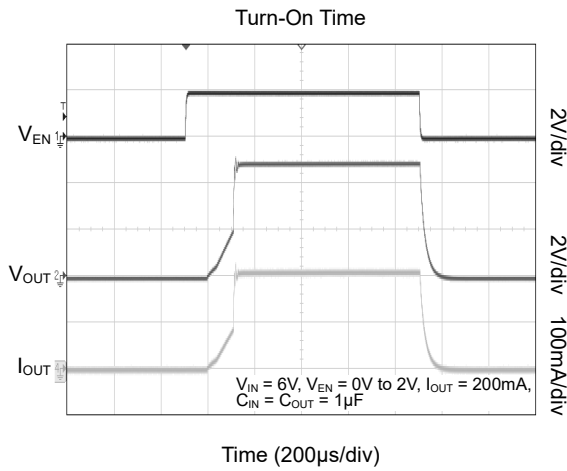

TYPICAL PERFORMANCE CHARACTERISTICS (continued)

T<sub>J</sub> = +25°C, C<sub>OUT</sub> = 2.2µF and I<sub>OUT</sub> = 100µA, unless otherwise noted.

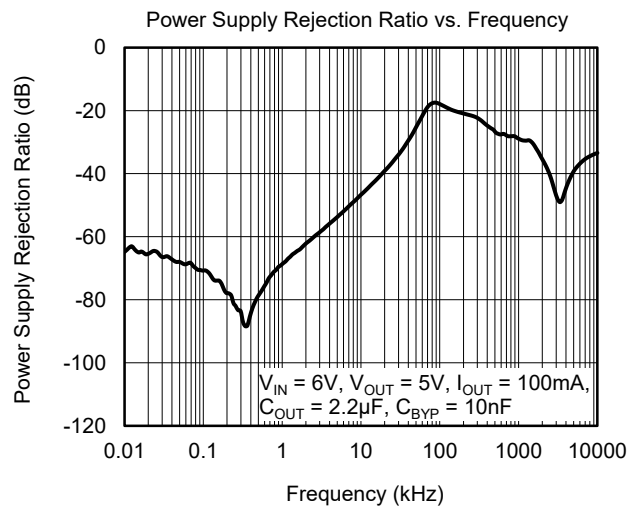
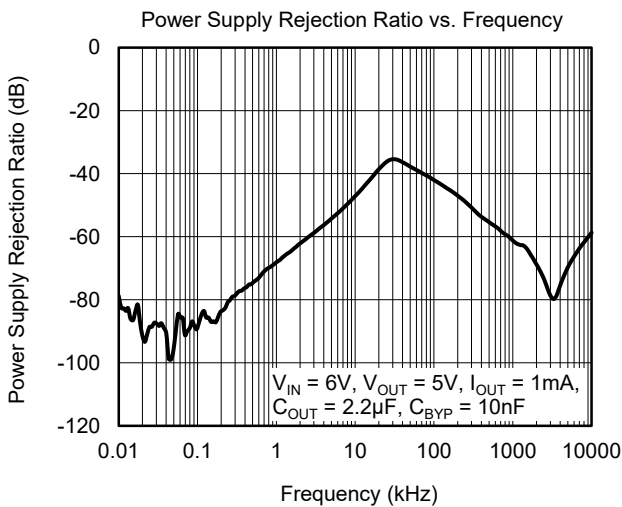
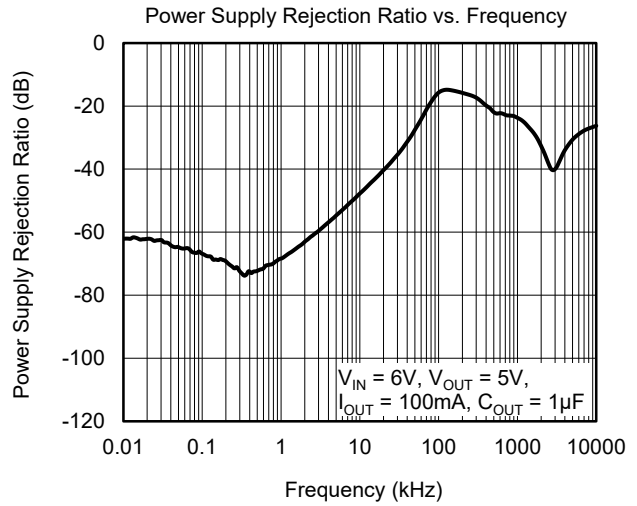
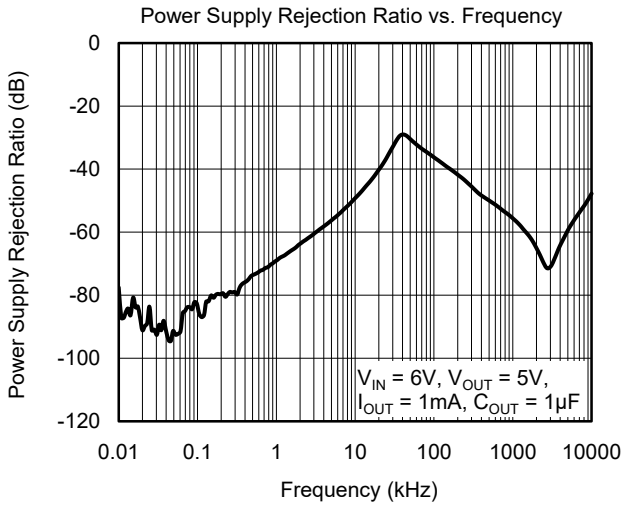
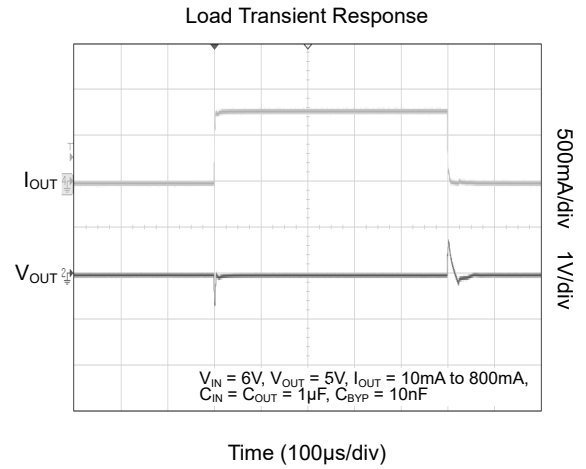
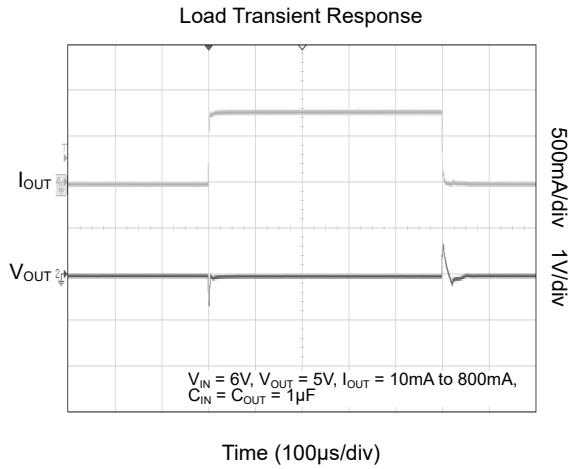

TYPICAL PERFORMANCE CHARACTERISTICS (continued)

$T_J = +25^\circ\text{C}$ ,  $C_{OUT} = 2.2\mu\text{F}$  and  $I_{OUT} = 100\mu\text{A}$ , unless otherwise noted.

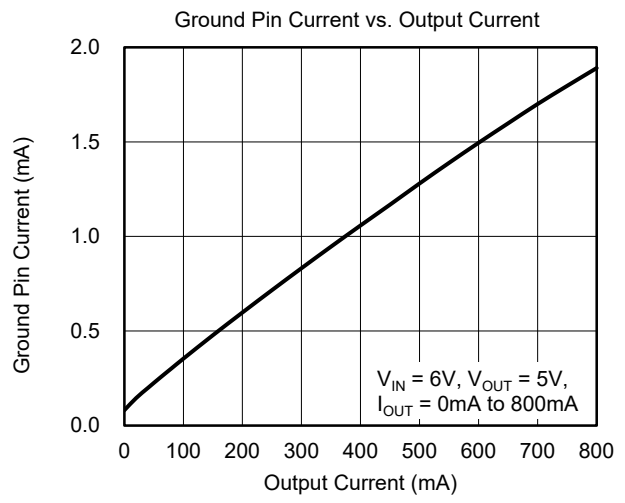
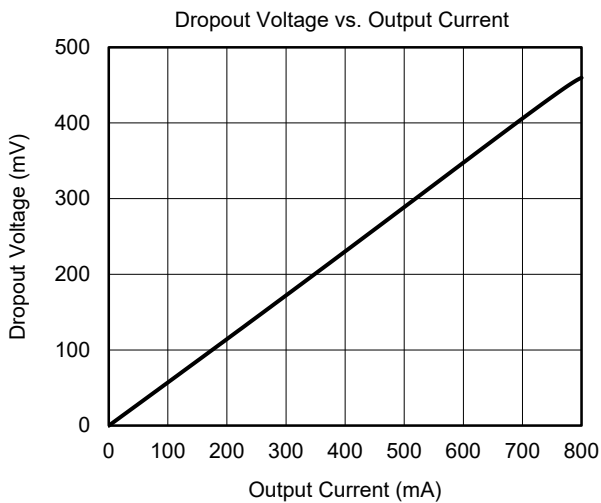
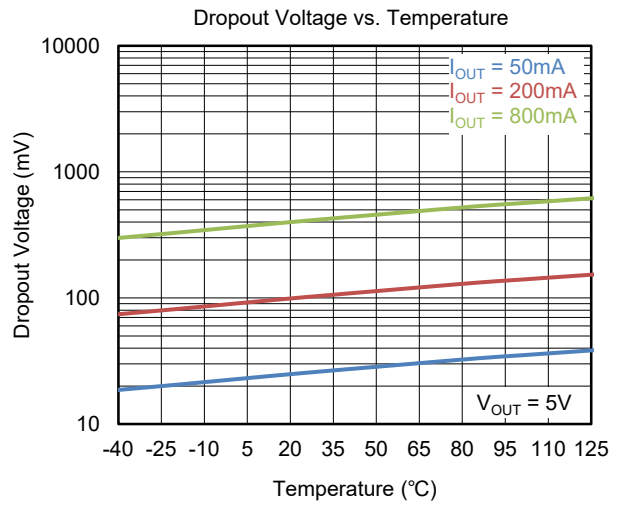
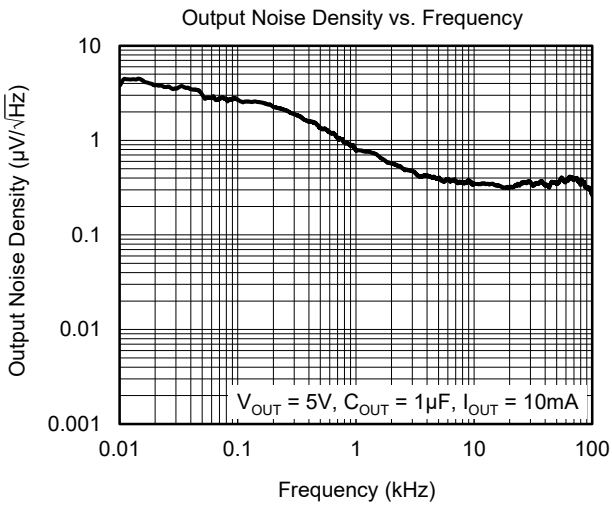
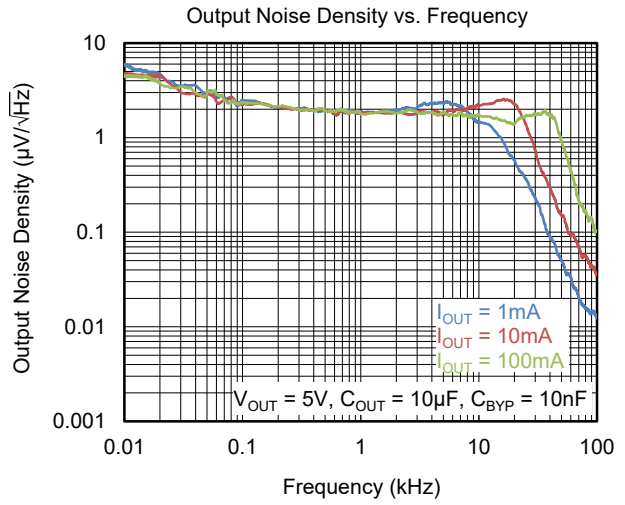
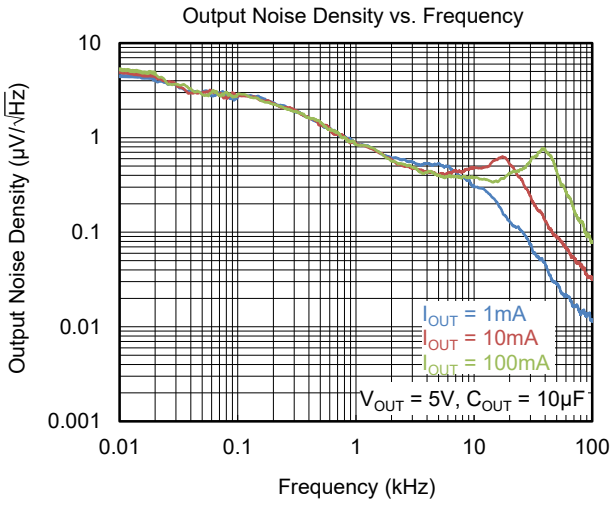



TYPICAL PERFORMANCE CHARACTERISTICS (continued)

$T_J = +25^\circ\text{C}$ ,  $C_{OUT} = 2.2\mu\text{F}$  and  $I_{OUT} = 100\mu\text{A}$ , unless otherwise noted.

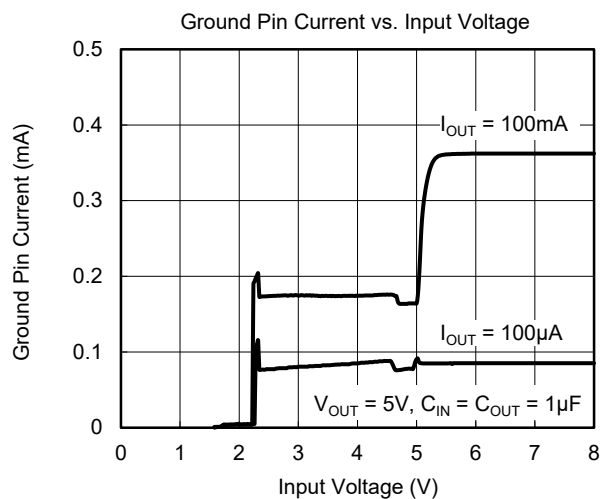
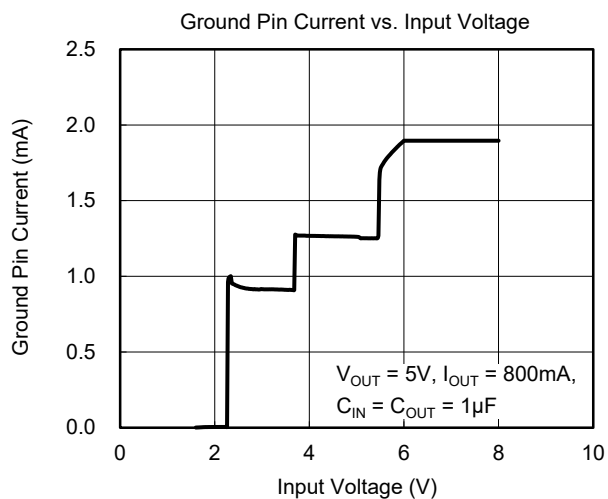
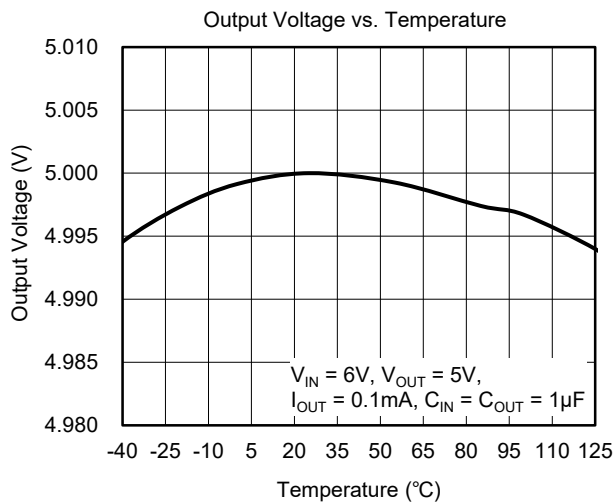
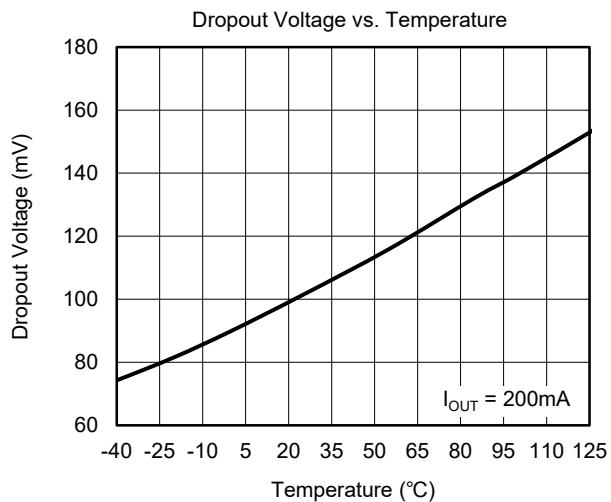

FUNCTIONAL BLOCK DIAGRAMS

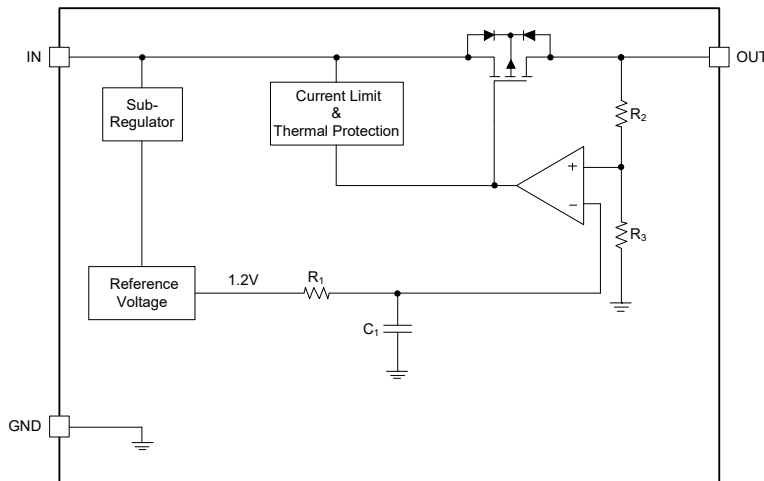

Figure 4. Internal Block Diagram of Fixed Output Voltage (SOT-89-3 and SOT-223-3 Versions)

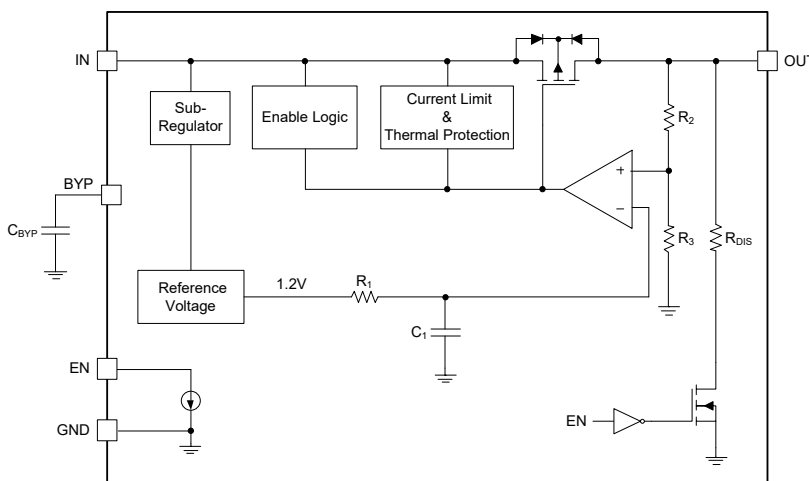

Figure 5. Internal Block Diagram of Low Noise Fixed Regulator (SOIC-8 Version)

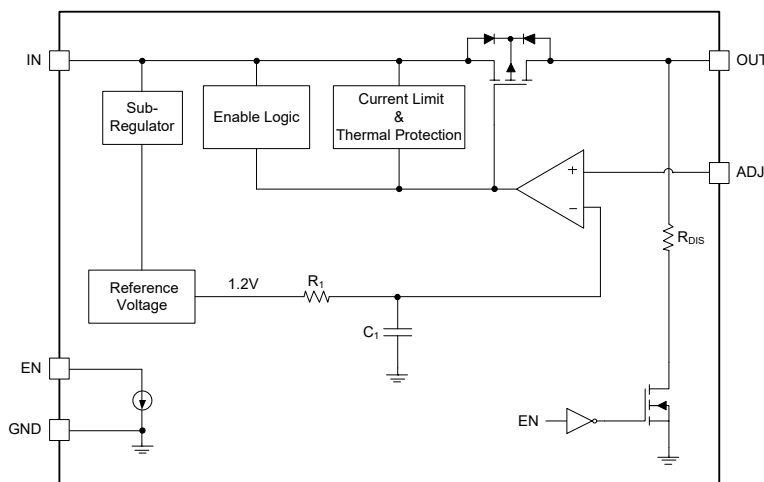

Figure 6. Internal Block Diagram of Adjustable Output Voltage (SOIC-8, TDFN-3x3-8L and TO-263-5B Versions)

## APPLICATION INFORMATION

The SGM2225 is a high voltage, low noise and low dropout LDO and provides 800mA output current. These features make the device a reliable solution to solve many challenging problems in the generation of clean and accurate power supply. The high performance also makes the SGM2225 useful in a variety of applications. The SGM2225 provides protection functions for output overload, output short-circuit condition and overheating.

The SGM2225 provides an EN pin as an external chip enable control to enable/disable the device.

### Input Capacitor Selection ( $C_{IN}$ )

The input decoupling capacitor should be placed as close as possible to the IN pin for ensuring the device stability. 1 $\mu$ F or larger X7R or X5R ceramic capacitor is selected to get good dynamic performance.

When  $V_{IN}$  is required to provide large current instantaneously, a large effective input capacitor is required. Multiple input capacitors can limit the input tracking inductance. Adding more input capacitors is available to restrict the ringing and to keep it below the device absolute maximum ratings.

### Output Capacitor Selection ( $C_{OUT}$ )

The output decoupling capacitor should be placed as close as possible to the OUT pin. 2.2 $\mu$ F or larger X7R or X5R ceramic capacitor is selected to get good dynamic performance. The minimum effective capacitance of  $C_{OUT}$  that SGM2225 can remain stable is 1 $\mu$ F. For ceramic capacitor, temperature, DC bias and package size will change the effective capacitance, so enough margin of  $C_{OUT}$  must be considered in design. Additionally,  $C_{OUT}$  with larger capacitance and lower ESR will help increase the high frequency PSRR and improve the load transient response.

### Noise Bypass Capacitor ( $C_{BYP}$ )

In noise sensitive applications, a bypass capacitor can be connected to the BYP pin (SOIC-8 package only) to reduce the noise of output voltage. A 10nF ceramic capacitor is recommended in application.

### Output Current Limit and Short-Circuit Protection

When overload events happen, the output current is internally limited to 1100mA (TYP). When the OUT pin

is shorted to ground, the short-circuit protection will limit the output current to 230mA (TYP).

### Thermal Shutdown

The SGM2225 can detect the temperature of die. When the die temperature exceeds the threshold value of thermal shutdown, the SGM2225 will be in shutdown state and remain in this state until the die temperature decreases to +130°C.

### Adjustable Regulator

The output voltage of the SGM2225-ADJ can be adjusted from 1.8V to 15V. The ADJ pin will be connected with two external resistors as shown in Figure 7, the output voltage is determined by the following equation:

$$V_{OUT} = V_{REF} \times \left( 1 + \frac{R_1}{R_2} \right) \quad (1)$$

where:

$V_{OUT}$  is output voltage and  $V_{FB}$  is the internal voltage reference,  $V_{REF} = 1.2V$ .

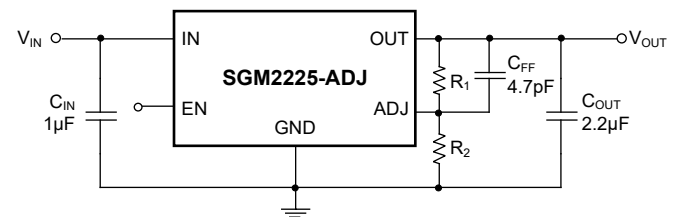

Figure 7. Adjustable Output Voltage Application

$R_1$  and  $R_2$  can be calculated for any output voltage range using equation 1 and  $R_1$  is recommended to be less than 470k $\Omega$ .

### Enable Operation

The EN pin of the SGM2225 is used to enable/disable the device and to deactivate/activate the output automatic discharge function.

When the EN pin voltage is lower than 0.4V, the device is in shutdown state. There is no current flowing from IN to OUT pins. In this state, the automatic discharge transistor is active to discharge the output voltage through a resistor.

When the EN pin voltage is higher than 1.6V, the device is in active state. The output voltage is regulated to expected value and the automatic discharge transistor is turned off.

**APPLICATION INFORMATION (continued)**

**No-Load Stability**

The SGM2225 can maintain stability without output load (except internal voltage divider).

**Input Power Supply**

The input power supply range is from 3.6V to 36V.  $V_{IN}$  must be larger than  $(V_{OUT} + V_{DROP})$  in application. The input ceramic capacitor must be placed as close as possible to the IN pin, this  $C_{IN}$  can help improve the output noise performance of LDO.

**Power Dissipation ( $P_D$ )**

Thermal protection limits power dissipation in the SGM2225. When power dissipation on pass element ( $P_D = (V_{IN} - V_{OUT}) \times I_{OUT}$ ) is too much and the operating junction temperature exceeds +155°C, the OTP circuit starts the thermal shutdown function and turns the pass element off.

Therefore, thermal analysis for the chosen application is important to guarantee reliable performance over all

conditions. To guarantee reliable operation, the junction temperature of the SGM2225 must not exceed +125°C.

The maximum allowable power dissipation depends on the thermal resistance of the IC package, the PCB layout, the rate of surrounding airflow, and the difference between the junction temperature and ambient temperature. The maximum power dissipation can be approximated using the following equation:

$$P_{D(MAX)} = (T_{J(MAX)} - T_A) / \theta_{JA} \quad (2)$$

where  $T_{J(MAX)}$  is the maximum junction temperature,  $T_A$  is the ambient temperature, and  $\theta_{JA}$  is the junction -to-ambient thermal resistance.

**Layout Guidelines**

To get good PSRR, low output noise and high transient response performance, the input and output bypass capacitors must be placed as close as possible to the IN pin and OUT pin separately.  $V_{IN}$  and  $V_{OUT}$  had better use separate ground planes and these ground planes are single point connected to the GND pin.

**REVISION HISTORY**

NOTE: Page numbers for previous revisions may differ from page numbers in the current version.

<b>APRIL 2022 – REV.A.1 to REV.A.2</b>	<b>Page</b>
Added SGM2225-2.5XK3G/TR, SGM2225-2.5XS8G/TR and SGM2225-2.5XTDB8G/TR versions .....	All
Updated Electrical Characteristics section .....	5
<b>MARCH 2021 – REV.A to REV.A.1</b>	<b>Page</b>
Added SGM2225-2.5XKC3G/TR version .....	All
Updated Electrical Characteristics section .....	5
<b>Changes from Original (MARCH 2021) to REV.A</b>	<b>Page</b>
Changed from product preview to production data .....	All

PACKAGE OUTLINE DIMENSIONS

SOT-89-3

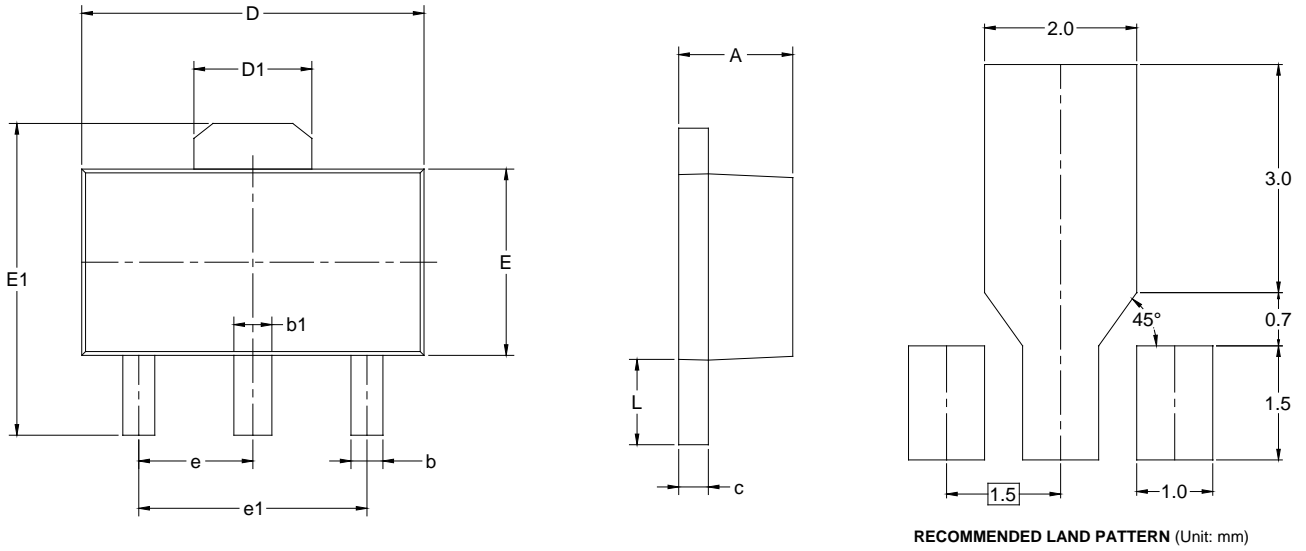

RECOMMENDED LAND PATTERN (Unit: mm)

Symbol	Dimensions In Millimeters		Dimensions In Inches	
	MIN	MAX	MIN	MAX
A	1.400	1.600	0.055	0.063
b	0.320	0.520	0.013	0.020
b1	0.400	0.580	0.016	0.023
c	0.350	0.440	0.014	0.017
D	4.400	4.600	0.173	0.181
D1	1.550 REF		0.061 REF	
E	2.300	2.600	0.091	0.102
E1	3.940	4.250	0.155	0.167
e	1.500 TYP		0.060 TYP	
e1	3.000 TYP		0.118 TYP	
L	0.900	1.200	0.035	0.047

NOTES:

1. Body dimensions do not include mode flash or protrusion.
2. This drawing is subject to change without notice.

# PACKAGE INFORMATION

## PACKAGE OUTLINE DIMENSIONS

### SOT-223-3

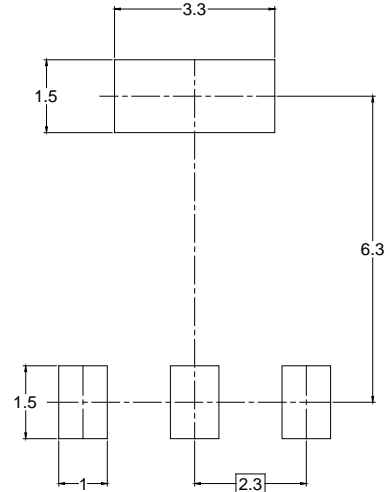
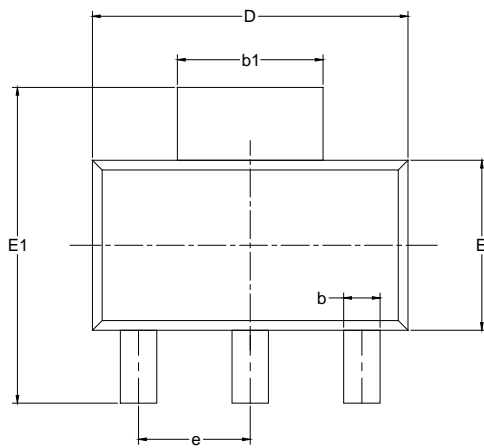

RECOMMENDED LAND PATTERN (Unit: mm)

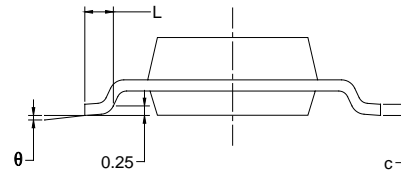
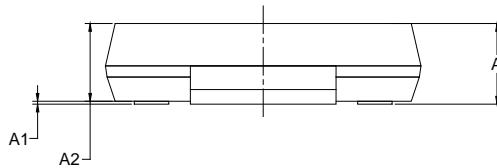

Symbol	Dimensions In Millimeters		Dimensions In Inches	
	MIN	MAX	MIN	MAX
A		1.800		0.071
A1	0.020	0.100	0.001	0.004
A2	1.500	1.700	0.059	0.067
b	0.660	0.840	0.026	0.033
b1	2.900	3.100	0.114	0.122
c	0.230	0.350	0.009	0.014
D	6.300	6.700	0.248	0.264
E	3.300	3.700	0.130	0.146
E1	6.700	7.300	0.264	0.287
e	2.300 BSC		0.091 BSC	
L	0.750		0.030	
$\theta$	0°	10°	0°	10°

**NOTES:**

1. Body dimensions do not include mode flash or protrusion.
2. This drawing is subject to change without notice.

PACKAGE OUTLINE DIMENSIONS

SOIC-8

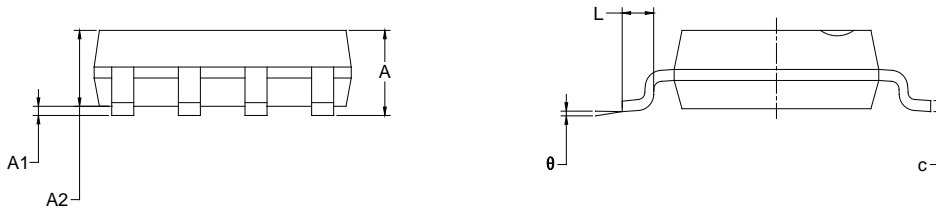
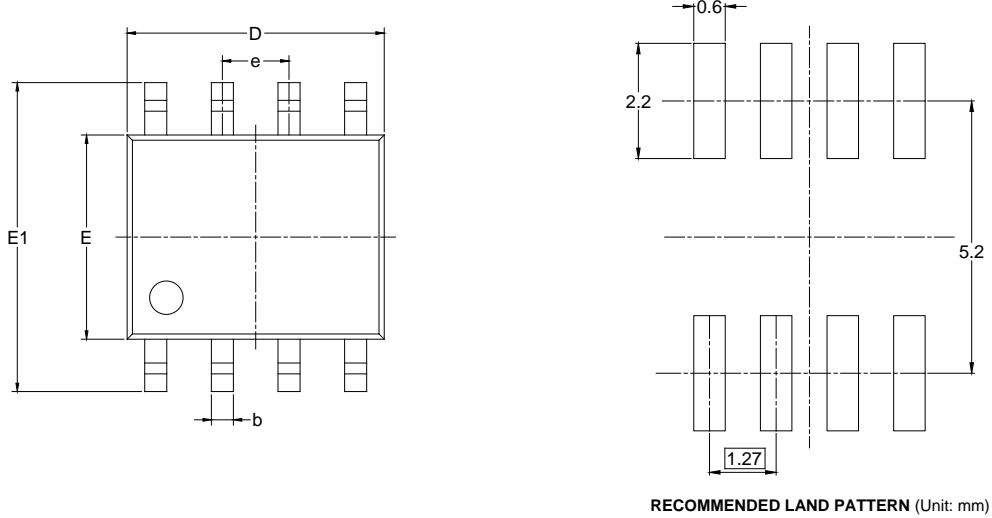

Symbol	Dimensions In Millimeters		Dimensions In Inches	
	MIN	MAX	MIN	MAX
A	1.350	1.750	0.053	0.069
A1	0.100	0.250	0.004	0.010
A2	1.350	1.550	0.053	0.061
b	0.330	0.510	0.013	0.020
c	0.170	0.250	0.006	0.010
D	4.700	5.100	0.185	0.200
E	3.800	4.000	0.150	0.157
E1	5.800	6.200	0.228	0.244
e	1.27 BSC		0.050 BSC	
L	0.400	1.270	0.016	0.050
θ	0°	8°	0°	8°

- NOTES:  
 1. Body dimensions do not include mode flash or protrusion.  
 2. This drawing is subject to change without notice.

# PACKAGE INFORMATION

## PACKAGE OUTLINE DIMENSIONS

### TDFN-3x3-8L

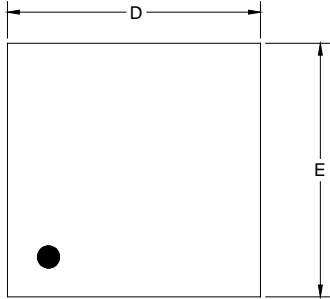

TOP VIEW

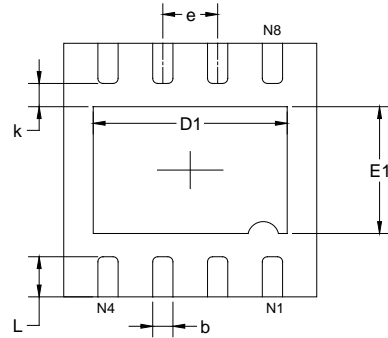

BOTTOM VIEW

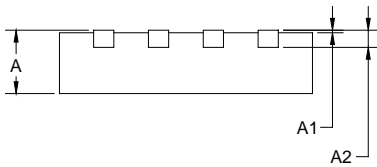

SIDE VIEW

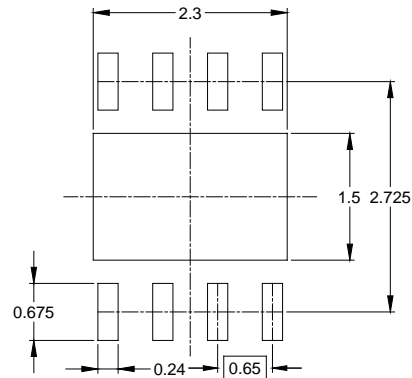

RECOMMENDED LAND PATTERN (Unit: mm)

Symbol	Dimensions In Millimeters		Dimensions In Inches	
	MIN	MAX	MIN	MAX
A	0.700	0.800	0.028	0.031
A1	0.000	0.050	0.000	0.002
A2	0.203 REF		0.008 REF	
D	2.900	3.100	0.114	0.122
D1	2.200	2.400	0.087	0.094
E	2.900	3.100	0.114	0.122
E1	1.400	1.600	0.055	0.063
k	0.200 MIN		0.008 MIN	
b	0.180	0.300	0.007	0.012
e	0.650 TYP		0.026 TYP	
L	0.375	0.575	0.015	0.023

NOTE: This drawing is subject to change without notice.



PACKAGE OUTLINE DIMENSIONS

TO-263-5B

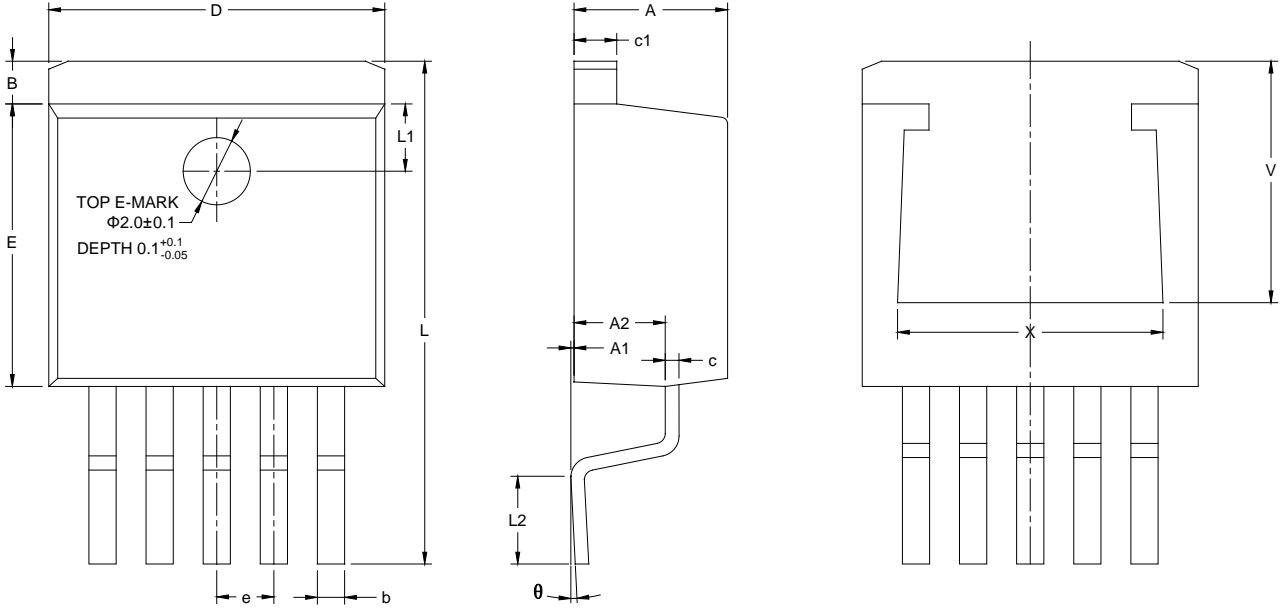

Symbol	Dimensions In Millimeters		
	MIN	MOD	MAX
A	4.40	4.57	4.70
A1	0	0.10	0.25
A2	2.59	2.69	2.79
b	0.77	-	0.90
c	0.34	-	0.47
c1	1.22	-	1.32
e	1.70 BSC		
D	10.06	10.16	10.26
E	9.05	9.15	9.25
B	1.17	1.27	1.40
V	6.86	-	7.50
X	7.50	-	8.30
L	14.70	15.10	15.50
L1	2.00 REF		
L2	2.00	2.30	2.60
$\theta$	0°	-	8°

- NOTES:  
 1. Body dimensions do not include mode flash or protrusion.  
 2. This drawing is subject to change without notice.

## TAPE AND REEL INFORMATION

### REEL DIMENSIONS

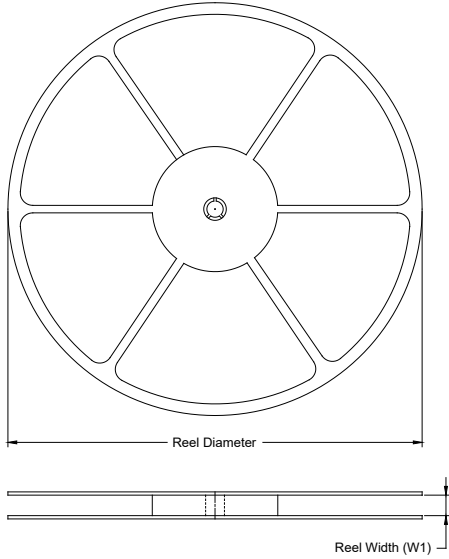

### TAPE DIMENSIONS

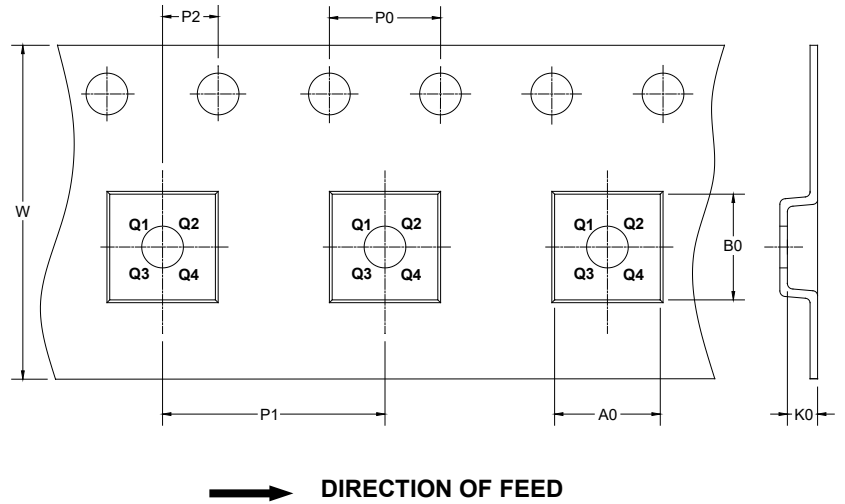

NOTE: The picture is only for reference. Please make the object as the standard.

### KEY PARAMETER LIST OF TAPE AND REEL

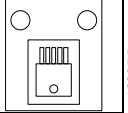
Package Type	Reel Diameter	Reel Width W1 (mm)	A0 (mm)	B0 (mm)	K0 (mm)	P0 (mm)	P1 (mm)	P2 (mm)	W (mm)	Pin1 Quadrant
SOT-89-3	7"	13.2	4.85	4.45	1.85	4.0	8.0	2.0	12.0	Q3
SOT-223-3	13"	12.4	6.55	7.25	1.90	4.0	8.0	2.0	12.0	Q3
SOIC-8	13"	12.4	6.40	5.40	2.10	4.0	8.0	2.0	12.0	Q1
TDFN-3×3-8L	13"	12.4	3.35	3.35	1.13	4.0	8.0	2.0	12.0	Q1
TO-263-5B	13"	24.4	10.80	16.30	5.11	4.0	16.0	2.0	24.0	

D20001

# PACKAGE INFORMATION

## CARTON BOX DIMENSIONS



NOTE: The picture is only for reference. Please make the object as the standard.

## KEY PARAMETER LIST OF CARTON BOX

Reel Type	Length (mm)	Width (mm)	Height (mm)	Pizza/Carton
7" (Option)	368	227	224	8
7"	442	410	224	18
13"	386	280	370	5

DD0002