

BQ25170: 800-mA Linear Battery Charger for 1-Cell Li-Ion, and LiFePO₄

1 Features

- Input voltage up-to 30-V tolerant
- Automatic Sleep Mode for low power consumption
 - 350-nA battery leakage current
 - 85- μ A input leakage current when charge disabled
- Supports 1-cell Li-Ion, Li-Poly, and LiFePO₄
- External resistor programmable operation
 - VSET to set battery regulation voltage:
 - Li-Ion: 4.05 V, 4.1 V, 4.2 V, 4.35 V, 4.4 V
 - LiFePO₄: 3.5 V, 3.6 V, 3.7 V
 - ISET to set charge current from 10 mA to 800 mA
- High accuracy
 - $\pm 0.5\%$ charge voltage accuracy
 - $\pm 10\%$ charge current accuracy
- Charging features
 - Precharge current 20% of ISET
 - Termination current 10% of ISET
 - NTC thermistor input to monitor battery temperature
 - TS pin for charging function control
 - Open-drain output for status and fault indication
 - Open-drain output for power good indication
- Integrated fault protection
 - 6.6-V IN overvoltage protection
 - VSET based OUT overvoltage protection
 - 1000-mA overcurrent protection
 - 125°C thermal regulation; 150°C thermal shutdown protection
 - OUT short-circuit protection
 - VSET, ISET pins short/open protection

2 Applications

- [True wireless headsets](#)
- [Wearable accessories, smart band](#)
- [Beauty and grooming](#)
- [Electric toothbrush](#)
- [Fleet management, asset tracking](#)

3 Description

The BQ25170 is an integrated 800-mA linear charger for 1-cell Li-Ion, Li-Polymer, and LiFePO₄ batteries targeted at space-limited portable applications. The device has a single power output that charges the battery. The system load can be placed in parallel with the battery, as long as the average system load does not prevent the battery from charging fully within the safety timer duration. When the system load is placed in parallel with the battery, the charge current is shared between the system and the battery.

The device has three phases for charging a Li-Ion battery: precharge to recover a fully discharged battery, fast-charge constant current to supply the bulk of the charge, and voltage regulation to reach full capacity.

In all charge phases, an internal control loop monitors the IC junction temperature and reduces the charge current if an internal temperature threshold, T_{REG} , is exceeded.

The charger power stage and charge current sense functions are fully integrated. The charger function has high accuracy current and voltage regulation loops, charge status display, and automatic charge termination. The charge voltage and fast charge current are programmable through external resistors. The precharge and termination current threshold track the fast charge current setting.

Device Information

PART NUMBER ⁽¹⁾	PACKAGE	BODY SIZE (NOM)
BQ25170	WSON (8)	2.0 mm x 2.0 mm

- (1) For all available packages, see the orderable addendum at the end of the data sheet.

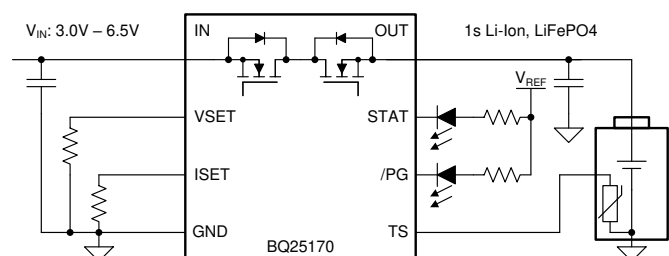

Simplified Schematic



Table of Contents

1 Features	1	7.4 Device Functional Modes.....	18
2 Applications	1	8 Application and Implementation	20
3 Description	1	8.1 Application Information.....	20
4 Revision History	2	8.2 Typical Applications.....	20
5 Pin Configuration and Functions	3	9 Power Supply Recommendations	25
6 Specifications	4	10 Layout	25
6.1 Absolute Maximum Ratings	4	10.1 Layout Guidelines.....	25
6.2 ESD Ratings	4	10.2 Layout Example.....	25
6.3 Recommended Operating Conditions	4	11 Device and Documentation Support	26
6.4 Thermal Information	5	11.1 Device Support.....	26
6.5 Electrical Characteristics	6	11.2 Receiving Notification of Documentation Updates..	26
6.6 Timing Requirements	8	11.3 Support Resources.....	26
6.7 Typical Characteristics.....	9	11.4 Trademarks.....	26
7 Detailed Description	11	11.5 Electrostatic Discharge Caution.....	26
7.1 Overview.....	11	11.6 Glossary.....	26
7.2 Functional Block Diagram.....	13	12 Mechanical, Packaging, and Orderable Information	27
7.3 Feature Description.....	14		

4 Revision History

NOTE: Page numbers for previous revisions may differ from page numbers in the current version.

Changes from Revision * (September 2020) to Revision A (April 2021)	Page
• Changed from Advance Information to Production Data.....	1

5 Pin Configuration and Functions

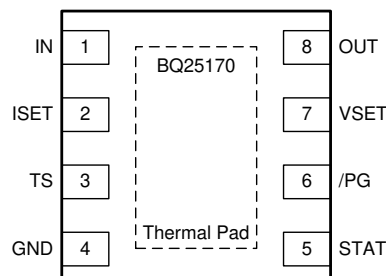

Figure 5-1. WSON Package 8-Pin Top View

Table 5-1. Pin Functions

PIN		I/O	DESCRIPTION
NAME	NUMBER		
IN	1	P	Input power, connected to external DC supply. Bypass IN with at least 1- μ F capacitor to GND, placed close to the IC.
ISET	2	I	Programs the device fast-charge current. External resistor from ISET to GND defines fast charge current value. Expected range is 30 k Ω (10 mA) to 375 Ω (800 mA). $ICHG = K_{ISET} / R_{ISET}$. Precharge current is defined as 20% of ICHG. Termination current is defined as 10% of ICHG.
TS	3	I	Temperature Qualification Voltage Input. Connect a negative temperature coefficient (NTC) thermistor directly from TS to GND (AT103-2 recommended). Charge suspends when the TS pin voltage is out of range. If TS function is not needed, connect an external 10-k Ω resistor from this pin to GND. Pulling TS < V_{TS_ENZ} will disable the charger.
GND	4	–	Ground pin
STAT	5	O	Open drain charger status indication output. Connect to pull-up rail via 10-k Ω resistor. LOW indicates charge in progress. HIGH indicates charge complete or charge disabled. When a fault condition is detected STAT pin blinks at 1 Hz.
PG	6	O	Open drain charge power good indication output. Connect to pull-up rail via 10-k Ω resistor. \overline{PG} pulls low when $V_{IN} > V_{IN_LOWV}$ and $V_{OUT} + V_{SLEEPZ} < V_{IN} < V_{IN_OV}$.
VSET	7	I	Programs the regulation voltage for OUT pin with a pull-down resistor. Valid resistor range is 18 k Ω to 100 k Ω , values outside this range will suspend charge. Refer to Section 7.3.1.2 for voltage level details. Recommend using $\pm 1\%$ tolerance resistor with <200 ppm/ $^{\circ}$ C temperature coefficient.
OUT	8	P	Battery Connection. System Load may be connected in parallel to battery. Bypass OUT with at least 1- μ F capacitor to GND, placed close to the IC.
Thermal Pad	—	—	Exposed pad beneath the IC for heat dissipation. Solder thermal pad to the board with vias connecting to solid GND plane.

6 Specifications

6.1 Absolute Maximum Ratings

over operating free-air temperature range (unless otherwise noted)⁽¹⁾

		MIN	MAX	UNIT
Voltage	IN	-0.3	30	V
Voltage	OUT	-0.3	13	V
Voltage	ISET, PG, STAT, TS, VSET	-0.3	5.5	V
Output Sink Current	PG, STAT		5	mA
T _J	Junction temperature	-40	150	°C
T _{stg}	Storage temperature	-65	150	°C

- (1) Stresses beyond those listed under *Absolute Maximum Rating* may cause permanent damage to the device. These are stress ratings only, which do not imply functional operation of the device at these or any other conditions beyond those indicated under *Recommended Operating Condition*. Exposure to absolute-maximum-rated conditions for extended periods may affect device reliability.

6.2 ESD Ratings

			VALUE	UNIT
V _(ESD)	Electrostatic discharge	Human body model (HBM), per ANSI/ESDA/ JEDEC JS-001, all pins ⁽¹⁾	±2500	V
		Charged device model (CDM), per JEDEC specification JESD22-C101, all pins ⁽²⁾	±1500	

- (1) JEDEC document JEP155 states that 500-V HBM allows safe manufacturing with a standard ESD control process.
 (2) JEDEC document JEP157 states that 250-V CDM allows safe manufacturing with a standard ESD control process.

6.3 Recommended Operating Conditions

over operating free-air temperature range (unless otherwise noted)

		MIN	NOM	MAX	UNIT
V _{IN}	Input voltage	3.0		6.6	V
V _{OUT}	Output voltage			4.4	V
I _{OUT}	Output current			0.8	A
T _J	Junction temperature	-40		125	°C
C _{IN}	IN capacitor	1			μF
C _{OUT}	OUT capacitor	1			μF
R _{VSET}	VSET resistor	18		100	kΩ
R _{VSET_TOL}	Tolerance for VSET resistor	-1		1	%
R _{VSET_TEMP}	Temperature coefficient for VSET resistor			200	ppm/°C
R _{ISET}	ISET resistor	0.375		30	kΩ
R _{TS}	TS thermistor resistor (recommend 103AT-2)		10		kΩ

6.4 Thermal Information

THERMAL METRIC ⁽¹⁾		BQ25170	
		DSG	
		8 PINS	
			UNIT
$R_{\theta JA}$	Junction-to-ambient thermal resistance (EVM ⁽²⁾)	37	°C/W
$R_{\theta JA}$	Junction-to-ambient thermal resistance (JEDEC ⁽¹⁾)	75.2	°C/W
$R_{\theta JC(top)}$	Junction-to-case (top) thermal resistance	93.4	°C/W
$R_{\theta JB}$	Junction-to-board thermal resistance	41.8	°C/W
Ψ_{JT}	Junction-to-top characterization parameter	3.8	°C/W
Ψ_{JB}	Junction-to-board characterization parameter	41.7	°C/W
$R_{\theta JC(bot)}$	Junction-to-case (bottom) thermal resistance	17.0	°C/W

- (1) For more information about traditional and new thermal metrics, see the [Semiconductor and IC Package Thermal Metrics](#) application report.
- (2) 1oz Copper, 2-layer board

6.5 Electrical Characteristics

$3.0V < V_{IN} < V_{IN_OV}$ and $V_{IN} > V_{OUT} + V_{SLEEP}$, $T_J = -40^{\circ}C$ to $+125^{\circ}C$, and $T_J = 25^{\circ}C$ for typical values (unless otherwise noted)

PARAMETER		TEST CONDITIONS	MIN	TYP	MAX	UNIT
QUIESCENT CURRENTS						
I _{Q_OUT}	Quiescent output current (OUT)	OUT = 4.2V, IN floating or IN = 0V - 5V, Charge Disabled, T _J = 25 °C	0.350		0.6	μA
		OUT = 4.2V, IN floating or IN = 0V - 5V, Charge Disabled, T _J < 105 °C	0.350		0.8	μA
I _{SD_IN_TS}	Shutdown input current (IN) with charge disabled via TS pin	IN = 5V, Charge Disabled (V _{TS} < V _{TS_ENZ}), no battery		80	110	μA
I _{STANDBY_IN}	Standby input current (IN) with charge terminated	IN = 5V, Charge Enabled, charge terminated		190		μA
I _{Q_IN}	Quiescent input current (IN)	IN = 5V, OUT = 3.8V, Charge Enabled, I _{CHG} = 0A		0.45	0.6	mA
INPUT						
V _{IN_OP}	IN operating range		3.0		6.6	V
V _{IN_LOWV}	IN voltage to start charging	IN rising	3.05	3.09	3.15	V
V _{IN_LOWV}	IN voltage to stop charging	IN falling	2.80	2.95	3.10	V
V _{SLEEPZ}	Exit sleep mode threshold	IN rising, V _{IN} - V _{OUT} , OUT = 4V	95	135	175	mV
V _{SLEEP}	Sleep mode threshold hysteresis	IN falling, V _{IN} - V _{OUT} , OUT = 4V		80		mV
V _{IN_OV}	VIN overvoltage rising threshold	IN rising	6.60	6.75	6.90	V
V _{IN_OVZ}	VIN overvoltage falling threshold	IN falling		6.63		V
CONFIGURATION PINS SHORT/OPEN PROTECTION						
R _{ISET_SHORT}	Highest resistor value considered short	R _{ISET} below this at startup, charger does not initiate charge, power cycle or TS toggle to reset			350	Ω
R _{VSET_SHORT}	Highest resistor value considered short	R _{VSET} below this at startup, charger does not initiate charge, power cycle or TS toggle to reset			2.8	kΩ
R _{VSET_OPEN}	Lowest resistor value considered open	R _{VSET} above this at startup, charger does not initiate charge, power cycle or TS toggle to reset	120			kΩ
BATTERY CHARGER						
V _{DO}	Dropout voltage (V _{IN} - V _{OUT})	VIN falling, V _{OUT} = 4.35V, I _{OUT} = 500mA		425		mV
V _{REG_ACC}	OUT charge voltage regulation accuracy	T _J = 25°C, all VSET settings	-0.5		0.5	%
		T _J = -40°C to 125°C, all VSET settings	-0.8		0.8	%
I _{CHG_RANGE}	Typical charge current regulation range	V _{OUT} > V _{BAT_LOWV}	10		800	mA
K _{ISET}	Charge current setting factor, I _{CHG} = K _{ISET} / R _{ISET}	10mA < I _{CHG} < 800mA	270	300	330	AΩ
I _{CHG_ACC}	Charge current accuracy	R _{ISET} = 375Ω, OUT = 3.8V	720	800	880	mA
		R _{ISET} = 600Ω, OUT = 3.8V	450	500	550	mA
		R _{ISET} = 3.0kΩ, OUT = 3.8V	90	100	110	mA
		R _{ISET} = 30kΩ, OUT = 3.8V	9	10	11	mA
I _{PRECHG}	Typical pre-charge current, as percentage of I _{CHG}	V _{OUT} < V _{BAT_LOWV}		20		%
I _{PRECHG_ACC}	Precharge current accuracy	R _{ISET} = 375Ω, OUT = 2.5V	144	160	176	mA
		R _{ISET} = 600Ω, OUT = 2.5V	85	100	110	mA
		R _{ISET} = 3.0kΩ, OUT = 2.5V	18	20	22	mA
		R _{ISET} = 30kΩ, OUT = 2.5V	1.4	2	2.6	mA

6.5 Electrical Characteristics (continued)

$3.0V < V_{IN} < V_{IN_OV}$ and $V_{IN} > V_{OUT} + V_{SLEEP}$, $T_J = -40^{\circ}C$ to $+125^{\circ}C$, and $T_J = 25^{\circ}C$ for typical values (unless otherwise noted)

PARAMETER		TEST CONDITIONS	MIN	TYP	MAX	UNIT
I_{TERM}	Typical termination current, as percentage of ICHG	$V_{OUT} = V_{REG}$		10		%
I_{TERM_ACC}	Termination current accuracy	$R_{ISET} = 600\Omega$, $OUT = V_{REG} = 4.2V$	45	50	55	mA
		$R_{ISET} = 3.0k\Omega$, $OUT = V_{REG} = 4.2V$	8.5	10	11.5	mA
		$R_{ISET} = 30k\Omega$, $OUT = V_{REG} = 4.2V$	0.4	1	1.6	mA
V_{BAT_SHORT}	Output (OUT) short circuit voltage rising threshold, for Li-Ion chemistry	OUT rising, VSET configured for Li-Ion	2.1	2.2	2.3	V
V_{BAT_SHORT}	Output (OUT) short circuit voltage rising threshold, for LiFePO ₄ chemistry	OUT rising, VSET configured for LiFePO ₄	1.1	1.2	1.3	V
$V_{BAT_SHORT_HYS}$	Output (OUT) short circuit voltage hysteresis	OUT falling		200		mV
I_{BAT_SHORT}	OUT short circuit charging current	$V_{OUT} < V_{BAT_SHORT}$	12	16	20	mA
V_{BAT_LOWV}	Pre-charge to fast-charge transition threshold, for Li-Ion chemistry	OUT rising, VSET configured for Li-Ion	2.7	2.8	3.0	V
V_{BAT_LOWV}	Pre-charge to fast-charge transition threshold for Li-FePO ₄ chemistry	OUT rising, VSET configured for LiFePO ₄	1.9	2.0	2.1	V
$V_{BAT_LOWV_HYS}$	Battery LOWV hysteresis	OUT falling		100		mV
V_{RECHG}	Battery recharge threshold for Li-Ion chemistry	OUT falling, VSET configured for Li-Ion $V_{REG_ACC} - V_{OUT}$	75	100	125	mV
V_{RECHG}	Battery recharge threshold for LiFePO ₄ chemistry	OUT falling, VSET configured for LiFePO ₄ , $V_{REG_ACC} - V_{OUT}$	175	200	225	mV
R_{ON}	Charging path FET on-resistance	$I_{OUT} = 400mA$, $T_J = 25^{\circ}C$		845	1000	m Ω
		$I_{OUT} = 400mA$, $T_J = -40 - 125^{\circ}C$		845	1450	m Ω
BATTERY CHARGER PROTECTION						
V_{OUT_OVP}	OUT overvoltage rising threshold	VOUT rising, as percentage of VSET	103	104	105	%
V_{OUT_OVP}	OUT overvoltage falling threshold	VOUT falling, as percentage of VSET	101	102	103	%
I_{OUT_OCP}	Output current limit threshold	IOUT rising	0.9	1	1.1	A
TEMPERATURE REGULATION AND TEMPERATURE SHUTDOWN						
T_{REG}	Typical junction temperature regulation			125		$^{\circ}C$
T_{SHUT}	Thermal shutdown rising threshold	Temperature increasing		150		$^{\circ}C$
	Thermal shutdown falling threshold	Temperature decreasing		135		$^{\circ}C$
BATTERY-PACK NTC MONITOR						
I_{TS_BIAS}	TS nominal bias current		36.5	38	39.5	μA
V_{COLD}	Cold temperature threshold	TS pin voltage rising (approx. $0^{\circ}C$)	0.99	1.04	1.09	V
	Cold temperature exit threshold	TS pin voltage falling (approx. $4^{\circ}C$)	0.83	0.88	0.93	V
V_{HOT}	Hot temperature threshold	TS pin voltage falling (approx. $45^{\circ}C$)	176	188	200	mV
	Hot temperature exit threshold	TS pin voltage rising (approx. $40^{\circ}C$)	208	220	232	mV
V_{TS_ENZ}	Charge Disable threshold. Crossing this threshold shall shutdown IC	TS pin voltage falling	40	50	60	mV
V_{TS_EN}	Charge Enable threshold. Crossing this threshold shall restart IC operation	TS pin voltage rising	65	75	85	mV
V_{TS_CLAMP}	TS maximum voltage clamp	TS pin open-circuit (float)	2.3	2.6	2.9	V
LOGIC OUTPUT PIN (STAT, PG)						
V_{OL}	Output low threshold level	Sink current = 5mA			0.4	V
I_{OUT_BIAS}	High-level leakage current	Pull up rail 3.3V			1	μA

6.6 Timing Requirements

		MIN	NOM	MAX	UNIT
BATTERY CHARGER					
$t_{TS_DUTY_ON}$	TS turn-on time during TS duty cycle mode		100		ms
$t_{TS_DUTY_OFF}$	TS turn-off time during TS duty cycle mode		2		s
$t_{OUT_OCP_DGL}$	Deglitch time for I_{OUT_OCP} , IOOUT rising		100		μ s
t_{PRECHG}	Pre-charge safety timer accuracy	28.5	30	31.5	min
t_{SAFETY}	Fast-charge safety timer accuracy	9.5	10	10.5	hr

6.7 Typical Characteristics

$C_{IN} = 1 \mu F$, $C_{OUT} = 1 \mu F$, $V_{IN} = 5 V$, $V_{OUT} = 3.8 V$ (unless otherwise specified)

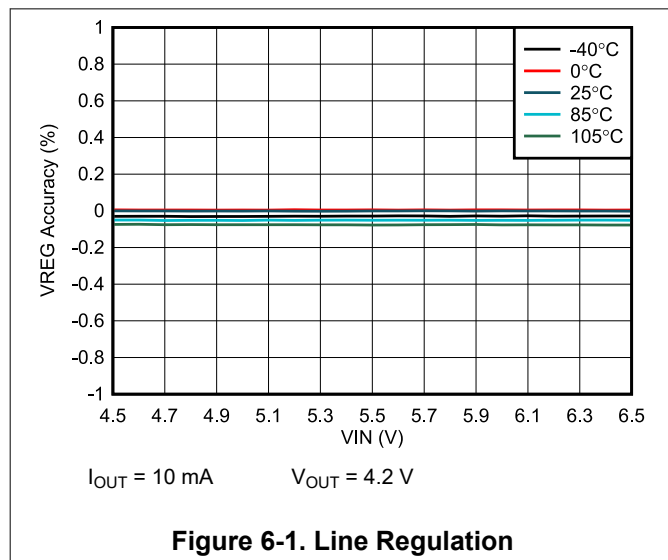

Figure 6-1. Line Regulation

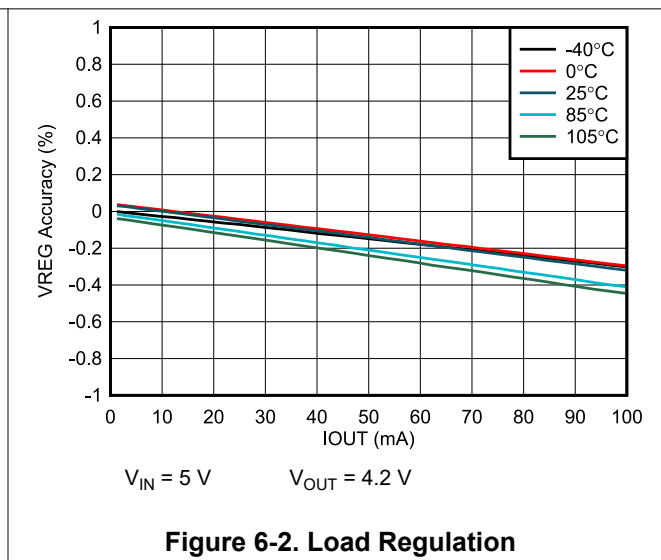

Figure 6-2. Load Regulation

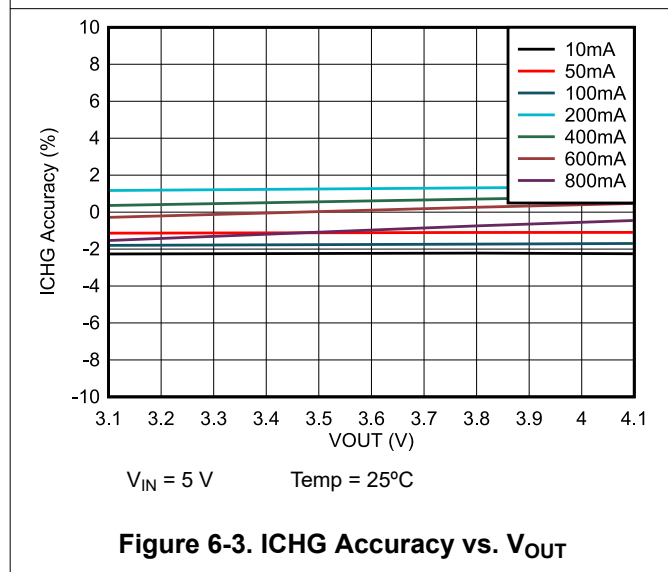

Figure 6-3. ICHG Accuracy vs. VOUT

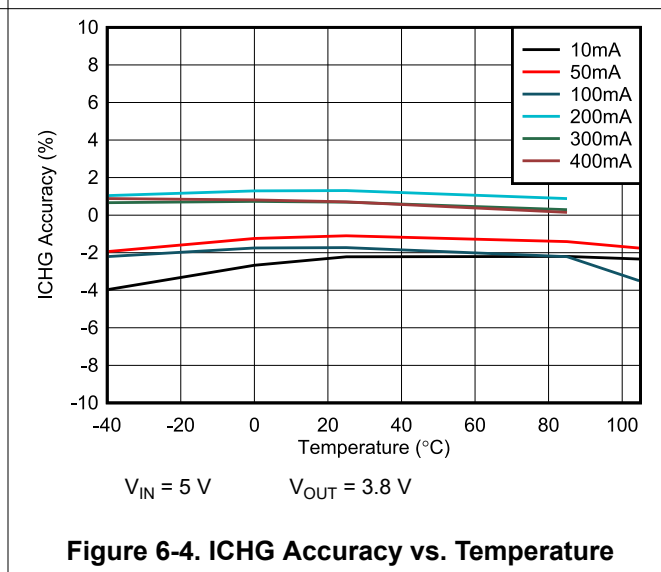
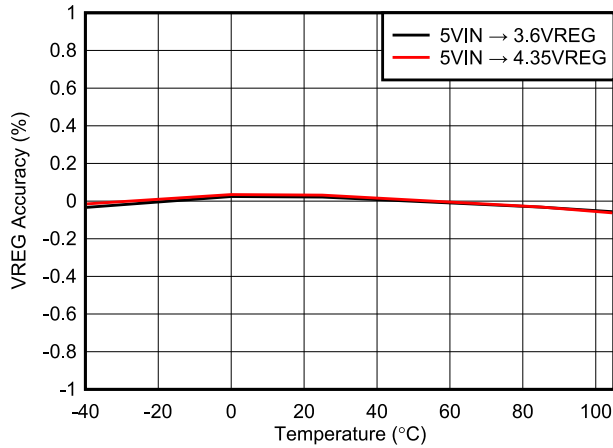

Figure 6-4. ICHG Accuracy vs. Temperature



$I_{OUT} = 10 \text{ mA}$

Figure 6-5. VSET Accuracy vs. Temperature

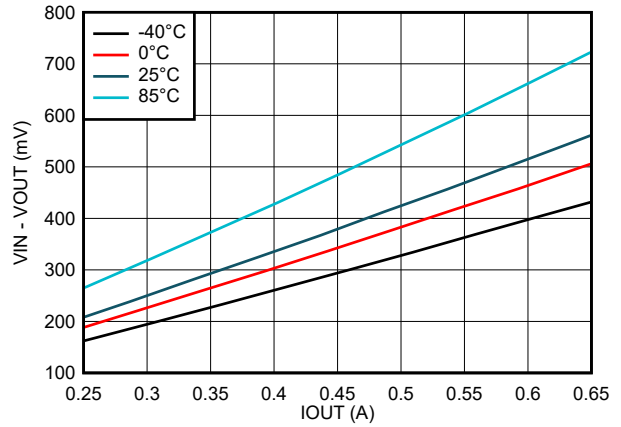
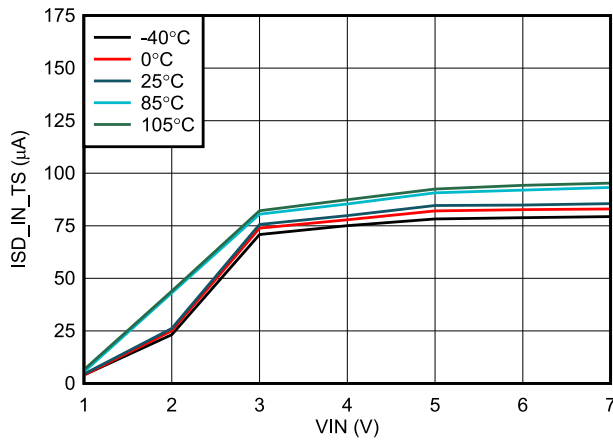

Figure 6-6. Dropout Voltage vs. Output Current



TS Pin = LOW

$V_{OUT} = 0 \text{ V}$

Figure 6-7. Input Shutdown Current vs. Input Voltage

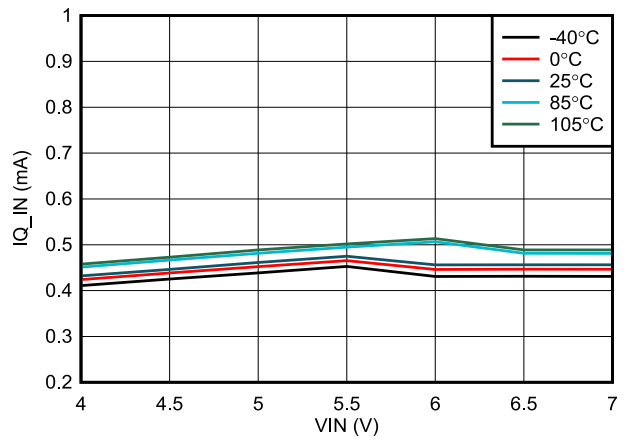

$I_{CHG} = 0 \text{ A}$

$V_{OUT} = 0 \text{ V}$

Figure 6-8. Input Quiescent Current vs. Input Voltage

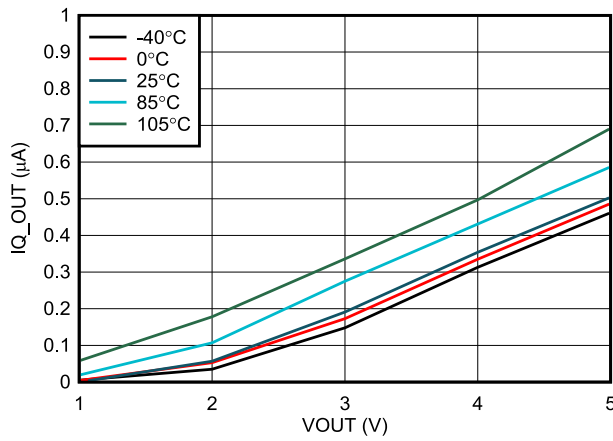

$V_{IN} = 0 \text{ V}$

Figure 6-9. Output Quiescent Current vs. Output Voltage

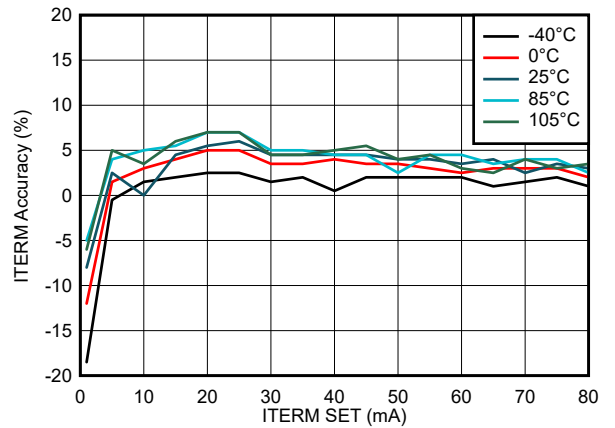

$V_{OUT} = 4.35 \text{ V}$

Figure 6-10. Termination Current Accuracy vs. Termination Current Setting

7 Detailed Description

7.1 Overview

The BQ25170 is an integrated 800-mA linear charger for 1-cell Li-Ion, Li-Polymer, and LiFePO₄ batteries. The device has a single power output that charges the battery. The system load can be placed in parallel with the battery, as long as the average system load does not prevent the battery from charging fully within the safety timer duration. When the system load is placed in parallel with the battery, the input current is shared between the system and the battery.

The device has three phases for charging a Li-Ion battery: precharge to recover a fully discharged battery, fast-charge constant current to supply the bulk of the charge, and voltage regulation to reach full capacity.

The charger includes flexibility in programming of the fast-charge current and regulation voltage. This charger is designed to work with a standard USB connection or dedicated charging adapter (DC output).

The charger also comes with a full set of safety features: battery temperature monitoring, overvoltage protection, charge safety timers, and configuration pin (VSET, ISET) short and open protection. All of these features and more are described in detail below.

The charger is designed for a single path from the input to the output to charge the battery. Upon application of a valid input power source, the configuration pins are checked for short/open circuit.

If the Li-Ion battery voltage is below the V_{BAT_LOWV} threshold, the battery is considered discharged and a preconditioning cycle begins. The amount of precharge current is 20% of the programmed fast-charge current via ISET pin. The t_{PRECHG} safety timer is active, and stops charging after expiration if battery voltage fails to rise above V_{BAT_LOWV} .

Once the battery has charged to the V_{BAT_LOWV} threshold, Fast Charge Mode is initiated, applying the fast charge current and starting the t_{SAFETY} timer. The fast charge constant current is programmed using the ISET pin. The constant current phase provides the bulk of the charge. Power dissipation in the IC is greatest in fast charge with a lower battery voltage. If the IC temperature reaches T_{REG} , the IC enters thermal regulation, slows the timer clock by half, and reduces the charge current as needed to keep the temperature from rising any further. [Figure 7-1](#) shows the typical Lithium battery charging profile with thermal regulation. Under normal operating conditions, the IC's junction temperature is less than T_{REG} and thermal regulation is not entered.

Once the battery has charged to the regulation voltage, the voltage loop takes control and holds the battery at the regulation voltage until the current tapers to the termination threshold. The termination threshold is 10% of the programmed fast-charge current.

Further details are described in [Section 7.3](#).

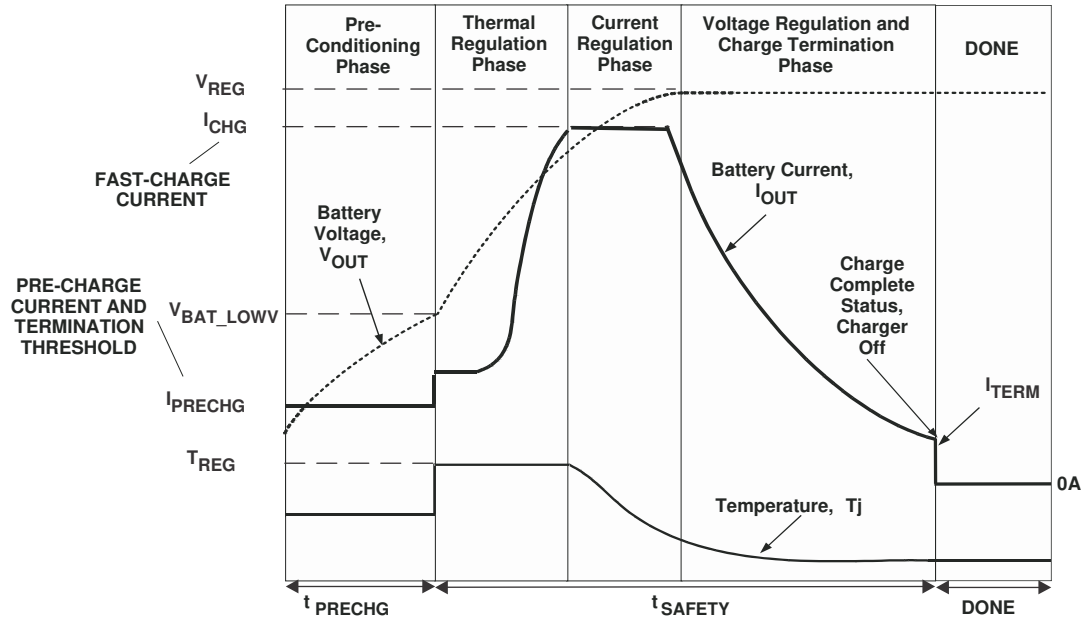
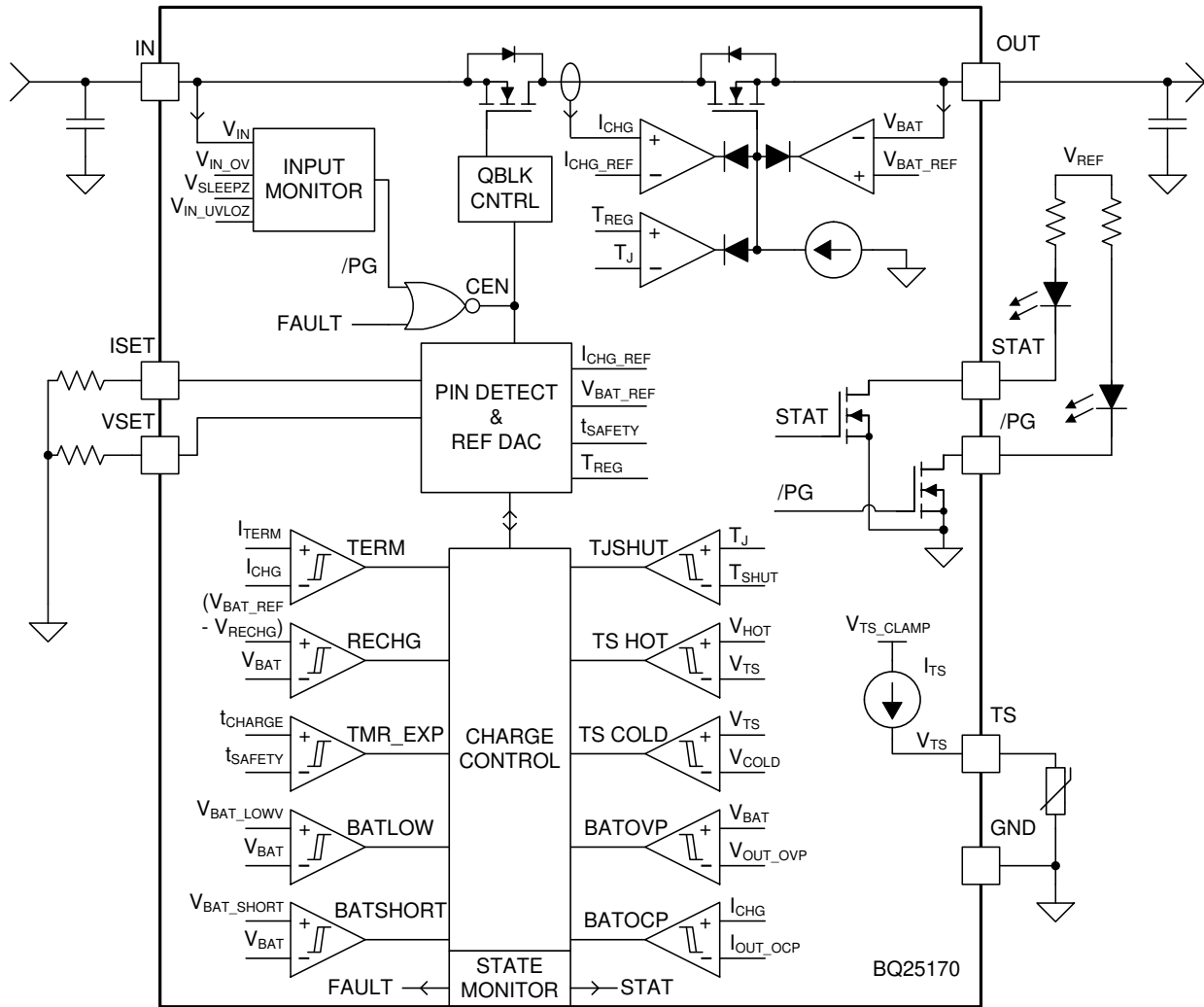

Figure 7-1. Lithium-Ion Battery Charging Profile with Thermal Regulation

7.2 Functional Block Diagram



7.3 Feature Description

7.3.1 Device Power Up from Input Source

When an input source is plugged in and charge is enabled, the device checks the input source voltage to turn on all the bias circuits. It detects and sets the charge current and charge voltage limits before the linear regulator is started. The power up sequence from input source is as listed:

1. ISET pin detection
2. VSET pin detection to select charge voltage
3. Charger power up

7.3.1.1 ISET Pin Detection

After a valid VIN is plugged in, the device checks the resistor on the ISET pin for a short circuit ($R_{ISET} < R_{ISET_SHORT}$). If a short condition is detected, the charger remains in the FAULT state until the input or TS pin is toggled. If the ISET pin is open-circuit, the charger proceeds through pin detection and starts the charger with no charge current. This pin is monitored while charging and changes in R_{ISET} while the charger is operating will immediately translate to changes in charge current.

An external pull-down resistor ($\pm 1\%$ or better recommended to minimize charge current error) from ISET pin to GND sets the charge current as:

$$I_{CHG} = \frac{K_{ISET}}{R_{ISET}} \quad (1)$$

where

- I_{CHG} is the desired fast-charge current
- K_{ISET} is a gain factor found in the electrical specifications
- R_{ISET} is the pull-down resistor from ISET pin to GND

For charge currents below 50 mA, an extra RC circuit is recommended on ISET to achieve more stable current signal. For greater accuracy at lower currents, part of the current-sensing FET is disabled to give better resolution.

7.3.1.2 VSET Pin Detection

VSET pin is used to program the device regulation voltage at end-of-charge using a $\pm 1\%$ pull-down resistor. The available pull-down resistor and corresponding charging levels are:

Table 7-1. VSET pin resistor value table

RESISTOR	CHARGE VOLTAGE (V)
> 150 kΩ	No Charge (open-circuit)
100 kΩ	1-cell LiFePO ₄ : 3.50 V
82 kΩ	1-cell LiFePO ₄ : 3.60 V
62 kΩ	1-cell LiFePO ₄ : 3.70 V
47 kΩ	1-cell Lilon: 4.05 V
36 kΩ	1-cell Lilon: 4.10 V
27 kΩ	1-cell Lilon: 4.20 V
24 kΩ	1-cell Lilon: 4.35 V
18 kΩ	1-cell Lilon: 4.40 V
< 3.0 kΩ	No Charge (short-circuit)

If either a short- or open-circuit condition is detected, charger stops operation and remains in the FAULT state until the input or TS pin is toggled.

Once a valid resistor value has been detected, the corresponding charge voltage is latched in and the pin is not continuously monitored during operation. A change in this pin will not be acknowledged by the IC until the input supply or TS pin is toggled.

7.3.1.3 Charger Power Up

After VSET, ISET pin resistor values have been validated, the device proceeds to enable the charger. The device automatically begins operation at the correct stage of battery charging depending on the OUT voltage.

7.3.2 Battery Charging Features

When charge is enabled, the device automatically completes a charging cycle according to the settings on VSET, ISET pins without any intervention. The lithium-based charging cycle is automatically terminated when the charging current is below termination threshold, charge voltage is above recharge threshold, and device is not in thermal regulation (TREG). When a full battery is discharged below the recharge threshold (V_{RECHG}), the device automatically starts a new charging cycle. After charge is done, toggling the input supply or the TS pin can initiate a new charging cycle.

7.3.2.1 Lithium-Ion Battery Charging Profile

The device charges a lithium based battery in four phases: trickle charge, precharge, constant current and constant voltage. At the beginning of a charging cycle, the device checks the battery voltage and regulates current and voltage accordingly.

If the charger is in thermal regulation during charging, the actual charging current will be less than the programmed value. In this case, termination is temporarily disabled and the charging safety timer is counted at half the clock rate. For more information, refer to [Section 7.3.2.3](#).

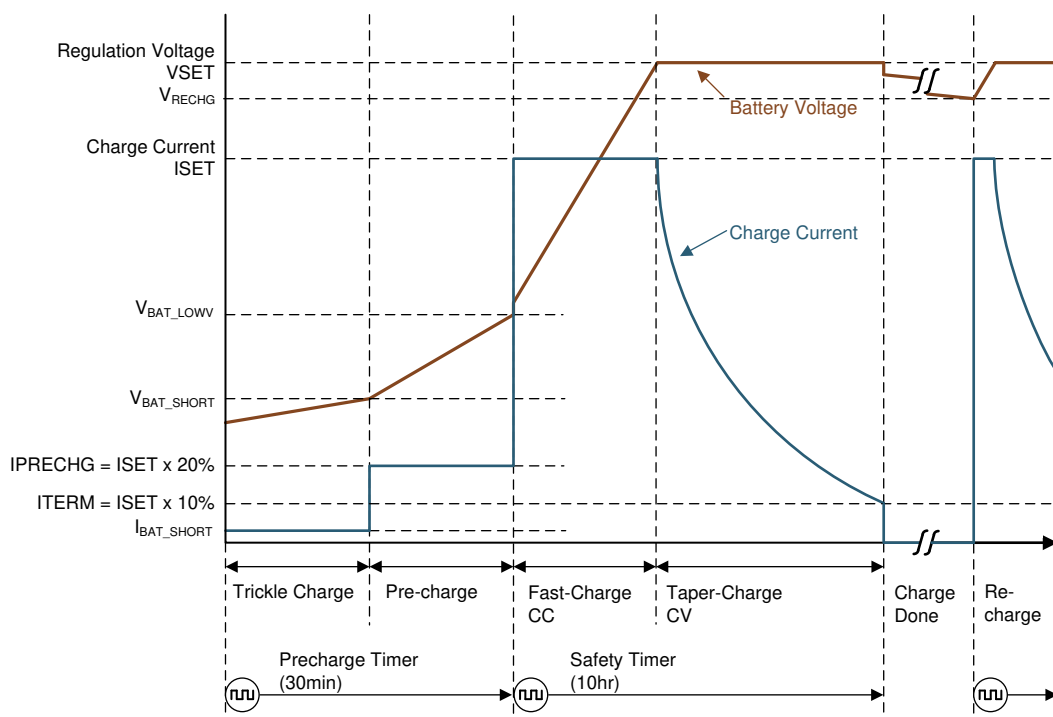

Figure 7-2. Battery Charging Profile

7.3.2.2 Charge Termination and Battery Recharge

The device terminates a charge cycle when the OUT pin voltage is above the recharge threshold (V_{RECHG}), and the current is below the termination threshold (I_{TERM}). Termination is temporarily disabled when the charger

device is in thermal regulation. After charge termination is detected, the linear regulator turns off and the device enters STANDBY state. Once the OUT pin drops below the V_{RECHG} threshold, a new charge cycle is automatically initiated.

7.3.2.3 Charging Safety Timers

The device has built-in safety timers to prevent an extended charging cycle due to abnormal battery conditions. The precharge timer is fixed at 30 minutes. The fast-charge safety timer is fixed at 10 hours. When safety timer expires, the charge cycle ends. A toggle on the input supply or TS pin is required to restart a charge cycle after the safety timer has expired.

During thermal regulation, the safety timer counts at half clock rate as the actual charge current is likely to be below the ISET setting. For example, if the charger is in thermal regulation throughout the whole charging cycle, and the safety timer is 10 hours, then the timer will expire in 20 hours.

During faults which disable charging, such as VIN OVP, BAT OVP, TSHUT or TS faults, the timer is suspended. Once the fault goes away, charging and the safety timer resumes. If the charging cycle is stopped and started again, the timer gets reset (toggle TS pin restarts the timer).

The safety timer restarts counting for the following events:

1. Charging cycle stop and restart (toggle TS pin, charged battery falls below recharge threshold, or toggle input supply)
2. OUT pin voltage crosses the V_{BAT_LOWV} threshold in either direction

The precharge safety timer (fixed counter that runs when $V_{OUT} < V_{BAT_LOWV}$), follows the same rules as the fast-charge safety timer in terms of getting suspended, reset, and counting at half-rate.

7.3.2.4 Battery Cold, Hot Temperature Qualification (TS Pin)

While charging, the device continuously monitors battery temperature by sensing the voltage at the TS pin. A negative temperature coefficient (NTC) thermistor should be connected between the TS and GND pins (recommend: 103AT-2). If temperature sensing is not required in the application, connect a fixed 10-k Ω resistor from TS to GND to allow normal operation. Battery charging is allowed when the TS pin voltage falls between V_{COLD} and V_{HOT} thresholds (typically 0°C – 45°C). The temperature corresponding to these voltage thresholds can be modified by adding resistors in parallel and in series with the thermistor, as shown in Figure 7-3. If the TS pin indicates battery temperature is outside this range, the device stops charging, enters the STANDBY state, and blinks the STAT pin. Once battery temperature returns to normal conditions, charging resumes automatically.

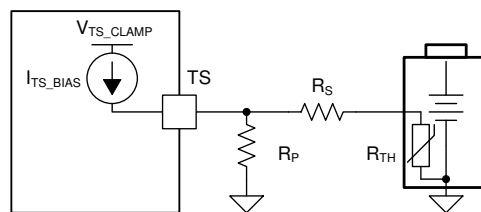

Figure 7-3. TS Resistor Network For Modified Temperature Charging Window

Table 7-2. Recommended Resistor Values for Different Temperature Charging Windows

TEMPERATURE CHARGING WINDOW	R_S	R_P
0°C to 60°C	1.9 k Ω	400 k Ω
-10°C to 60°C	2.3 k Ω	70 k Ω
-10°C to 50°C	1.1 k Ω	70 k Ω

In addition to battery temperature sensing, the TS pin can be used to disable the charger at any time by pulling TS voltage below V_{TS_ENZ} . The device disables the charger and consumes $I_{SD_IN_TS}$ from the input

supply. In order to minimize quiescent current, the TS current source (I_{TS_BIAS}) is duty-cycled, with an on-time of $t_{TS_DUTY_ON}$ and an off time of $t_{TS_DUTY_OFF}$. After the TS pin pull-down is released, the device may take up to $t_{TS_DUTY_OFF}$ to turn the I_{TS_BIAS} back on. After the source is turned on, the TS pin voltage will go above V_{TS_EN} , and re-enable the charger operation. The device treats this TS pin toggle as an input supply toggle, triggering Device Power Up From Input Source (Section 7.3.1).

7.3.3 Status Outputs (\overline{PG} , STAT)

7.3.3.1 Power Good Indicator (\overline{PG} Pin)

This open-drain pin pulls LOW to indicate a good input source when:

1. V_{IN} above V_{IN_LOWV}
2. V_{IN} above $V_{OUT} + V_{SLEEPZ}$ (not in SLEEP)
3. V_{IN} below V_{IN_OV}

7.3.3.2 Charging Status Indicator (STAT)

The device indicates the charging state on the open-drain STAT pin. This pin can drive an LED.

Table 7-3. STAT pin state

CHARGING STATE	STAT PIN STATE
Charge completed, charger in sleep mode or charge disabled ($V_{TS} < V_{TS_ENZ}$)	HIGH
Charge in progress (including automatic recharge)	LOW
Fault (V_{IN} OVP, BAT OVP, BAT OCP, TS HOT, TS COLD, TMR_EXP, VSET pin short/open or ISET pin short)	BLINK at 1Hz

7.3.4 Protection Features

The device closely monitors input and output voltage, as well as internal FET current and temperature for safe linear regulator operation.

7.3.4.1 Input Overvoltage Protection (VIN OVP)

If the voltage at IN pin exceeds V_{IN_OV} , the device turns off after a deglitch, $t_{VIN_OV_DGL}$. The safety timer suspends count and device enters STANDBY mode. Once the IN voltage recovers to normal level, the charge cycle and the safety timer automatically resume operation.

7.3.4.2 Output Overvoltage Protection (BAT OVP)

If the voltage at OUT pin exceeds V_{OUT_OVP} , the device immediately stops charging. The safety timer suspends count and device enters STANDBY mode. Once the OUT voltage recovers to normal level, the charge cycle and the safety timer resume operation.

7.3.4.3 Output Overcurrent Protection (BAT OCP)

During normal operation, the OUT current should be regulated to ISET programmed value. However, if a short circuit occurs on ISET pin, the OUT current may rise to unintended level. If the current at OUT pin exceeds I_{OUT_OCP} , the device turns off after a deglitch, $t_{OUT_OCP_DGL}$. The safety timer resets the count, and device remains latched off. An input supply or TS pin toggle is required to restart operation.

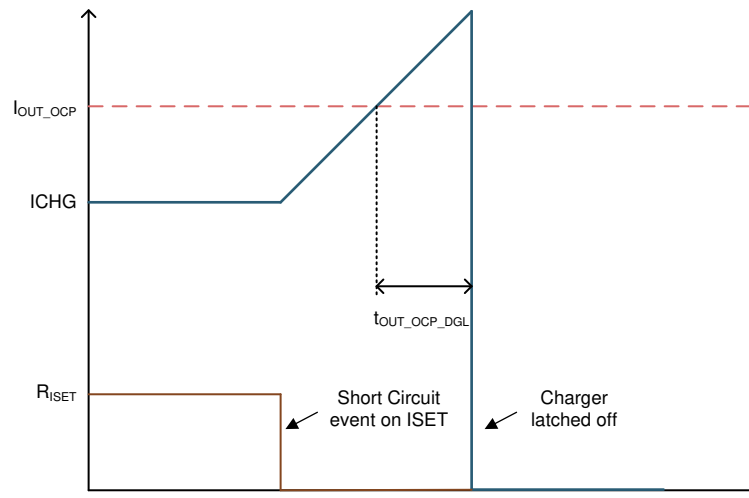

Figure 7-4. Overcurrent Protection

7.3.4.4 Thermal Regulation and Thermal Shutdown (TREG and TSHUT)

The device monitors its internal junction temperature (T_J) to avoid overheating and to limit the IC surface temperature. When the internal junction temperature exceeds the thermal regulation limit, the device automatically reduces the charge current to maintain the junction temperature at the thermal regulation limit (TREG). During thermal regulation, the actual charging current is usually below the programmed value on the ISET pin. Therefore, the termination comparator for the Lithium-Ion battery is disabled, and the safety timer runs at half the clock rate.

Additionally, the device has thermal shutdown to turn off the linear regulator when the IC junction temperature exceeds the TSHUT threshold. The charger resumes operation when the IC die temperature decreases below the TSHUT falling threshold.

7.4 Device Functional Modes

7.4.1 Shutdown or Undervoltage Lockout (UVLO)

The device is in shutdown state if the IN pin voltage is less than V_{IN_LOWV} , or the TS pin is below V_{TS_ENZ} . The internal circuitry is powered down, all the pins are high impedance, and the device draws $I_{SD_IN_TS}$ from the input supply. Once the IN voltage rises above the V_{IN_LOW} threshold and the TS pin is above V_{TS_EN} , the IC will enter Sleep Mode or Active Mode depending on the OUT pin voltage.

7.4.2 Sleep Mode

The device is in Sleep Mode when $V_{IN_LOWV} < V_{IN} < V_{OUT} + V_{SLEEPZ}$. The device waits for the input voltage to rise above $V_{OUT} + V_{SLEEPZ}$ to start operation.

7.4.3 Active Mode

The device is powered up and charges the battery when the TS pin is above V_{TS_ENZ} and the IN voltage ramps above both V_{IN_LOWV} , and $V_{OUT} + V_{SLEEPZ}$. The device draws I_{Q_IN} from the supply to bias the internal circuitry. For details on device power-up sequence, refer to [Section 7.3.1](#).

7.4.3.1 Standby Mode

The device is in Standby Mode if a valid input supply is present and charge is terminated or if a recoverable fault is detected. The internal circuitry is partially biased, and the device continues to monitor for either V_{OUT} to drop below V_{RECHG} , or the recoverable fault to be removed.

7.4.4 Fault Mode

The fault conditions are categorized into recoverable and nonrecoverable as follows:

- Recoverable, from which the device should automatically recover once the fault condition is removed:
 - VIN OVP
 - BAT OVP
 - TS HOT
 - TS COLD
- Nonrecoverable, requiring TS pin or input supply toggle to resume operation:
 - BAT OCP
 - ISET pin short detected
 - VSET pin short/open detected

8 Application and Implementation

Note

Information in the following applications sections is not part of the TI component specification, and TI does not warrant its accuracy or completeness. TI's customers are responsible for determining suitability of components for their purposes, as well as validating and testing their design implementation to confirm system functionality.

8.1 Application Information

A typical application consists of the device configured as a standalone battery charger for single-cell Lithium-Ion, Li-Polymer, or LiFePO₄ chemistries. The charge voltage and number of cells is configured using a pull-down resistor on the VSET pin. The charge current is configured using a pull-down resistor on the ISET pin. A battery thermistor may be connected to the TS pin to allow the device to monitor battery temperature and control charging. Pulling the TS pin below V_{TS_ENZ} disables the charging function. The charger and input supply status is reported via the STAT and PG pins.

8.2 Typical Applications

8.2.1 Li-Ion Charger Design Example

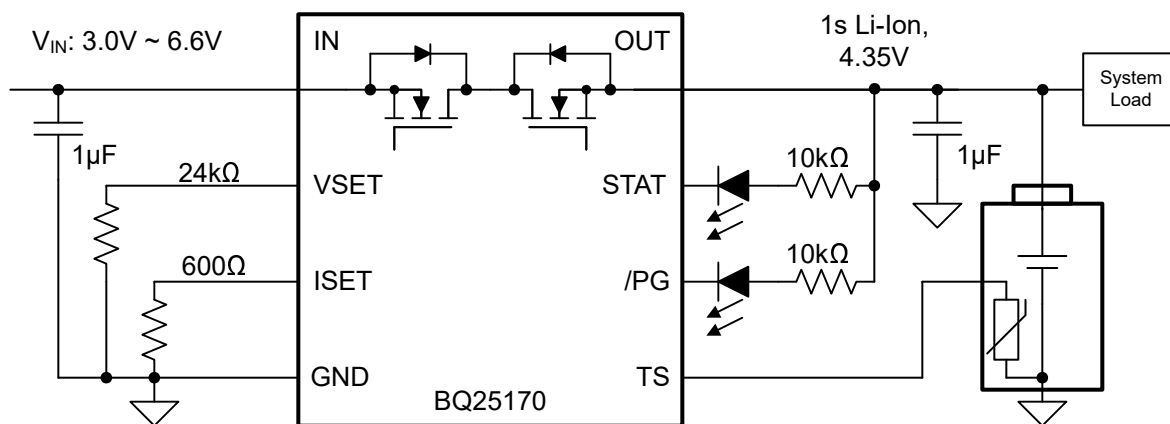

Figure 8-1. BQ25170 Typical Application for Li-Ion Charging at 500 mA

8.2.1.1 Design Requirements

- Supply voltage = 5 V
- Battery is single-cell Li-Ion
- Fast charge current: I_{CHG} = 500 mA
- Charge Voltage: V_{REG} = 4.35 V
- Termination Current: I_{TERM} = 10% of I_{CHG} or 50 mA
- Pre-charge Current: I_{PRECHG} = 20% of I_{CHG} or 100 mA
- TS – Battery Temperature Sense = 10-kΩ NTC (103AT)
- TS pin can be pulled down to disable charging

8.2.1.2 Detailed Design Procedure

The regulation voltage is set via the VSET pin to 4.35 V, the input voltage is 5 V and the charge current is programmed via the ISET pin to 500 mA.

$$R_{ISET} = [K_{ISET} / I_{CHG}]$$

from electrical characteristics table. . . K_{ISET} = 300 AΩ

$$R_{ISET} = [300 \text{ A}\Omega / 0.5 \text{ A}] = 600 \Omega$$

Selecting the closest 1% resistor standard value, use a 604-Ω resistor between ISET and GND, for an expected I_{CHG} 497 mA.

8.2.1.2.1 TS Function

Use a 10-k Ω NTC thermistor in the battery pack (recommend: 103AT-2). The VCOLD and VHOT thresholds in the data sheet are designed to meet a charging window between 0°C and 45°C for a 10-k Ω NTC with $\beta=3435K$. To disable the TS sense function, use a fixed 10-k Ω resistor between the TS and GND. The TS pin can be pulled down to disable charging.

8.2.1.3 Application Curves

$C_{IN} = 1 \mu F$, $C_{OUT} = 1 \mu F$, $V_{IN} = 5 V$, $V_{OUT} = 3.8 V$, $I_{CHG} = 250 mA$ (unless otherwise specified)

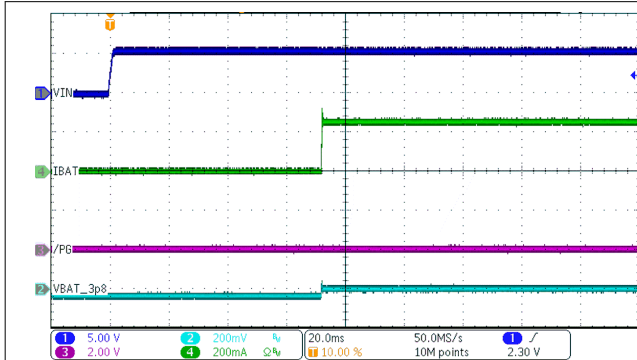

$R_{ISET} = 1.2 k\Omega$

Figure 8-2. Power Up With Battery

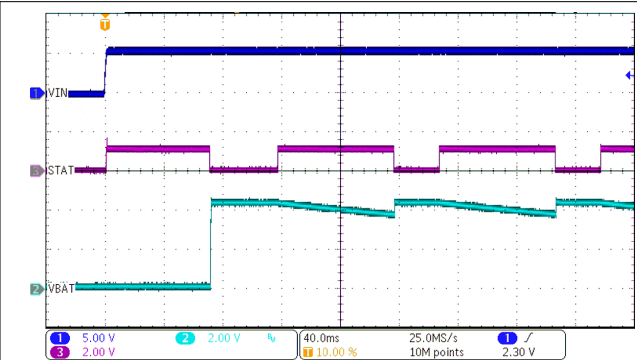

$R_{ISET} = 1.2 k\Omega$ OUT = open-circuit

Figure 8-3. Power Up Without Battery

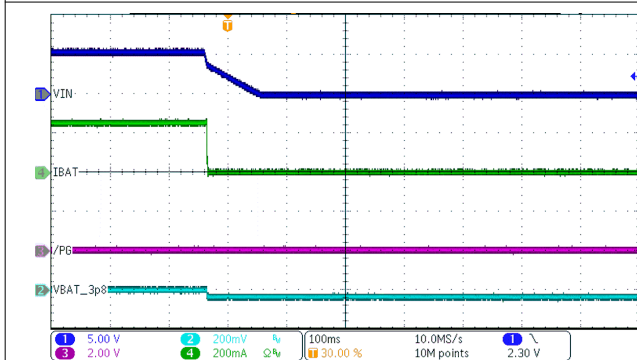

$V_{IN} = 5 V \rightarrow 0 V$

Figure 8-4. Power Down

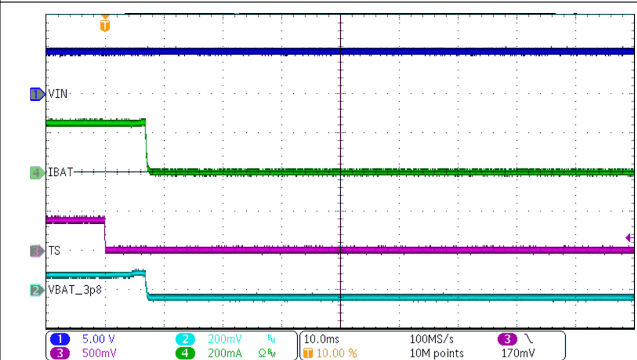

TS pulled LOW

Figure 8-5. Charge Disable

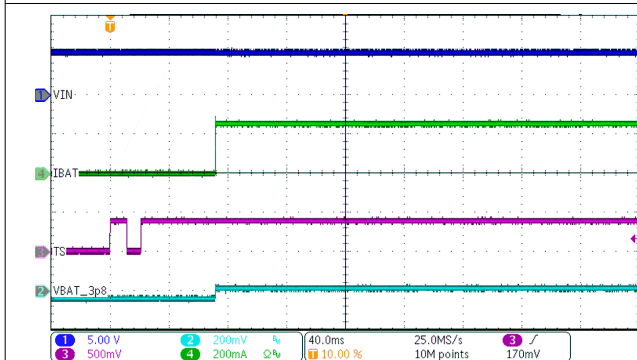

TS pin released

Figure 8-6. Charge Enable



$V_{IN} = 5 V \rightarrow 10 V \rightarrow 5 V$

Figure 8-7. IN OVP Response

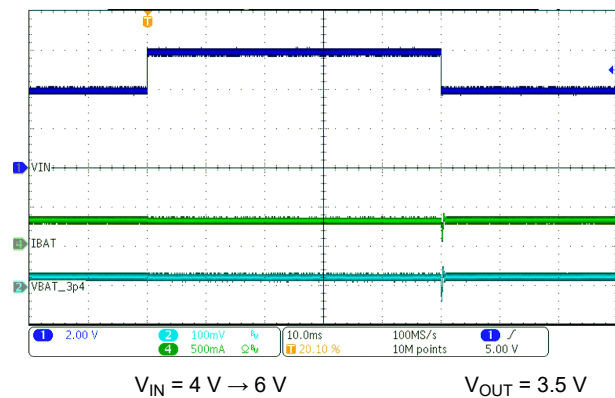

Figure 8-8. IN Transient Response

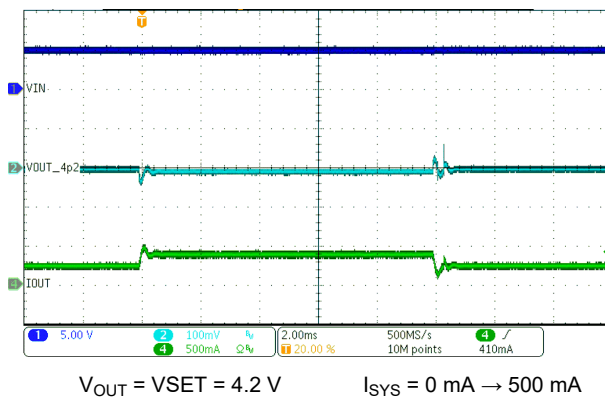

Figure 8-9. OUT Transient Response

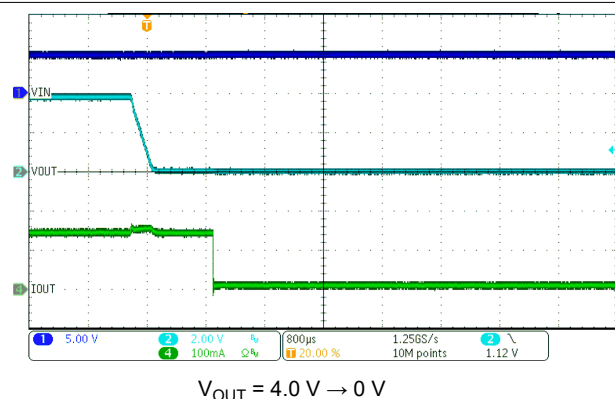

Figure 8-10. OUT Short-Circuit Response

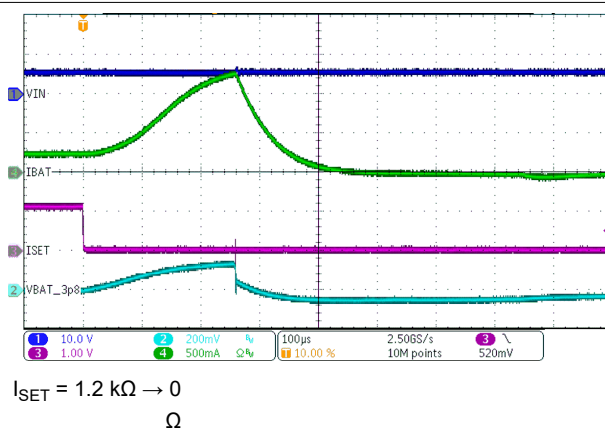

Figure 8-11. ISET Short-Circuit Response

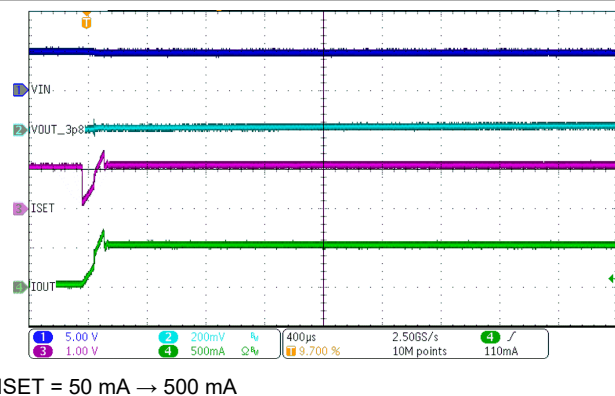

Figure 8-12. ISET Change Response

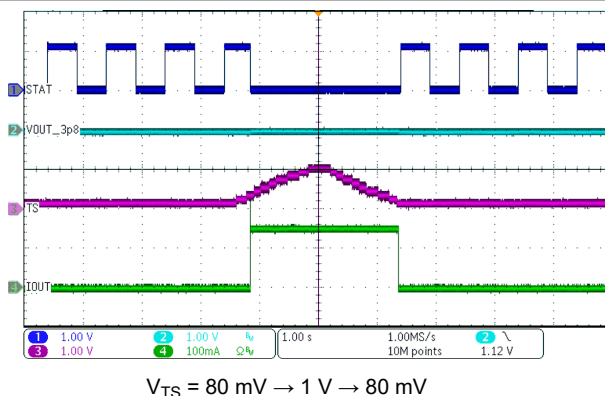

Figure 8-13. TS Change Response

8.2.2 LiFePO₄ Charger Design Example

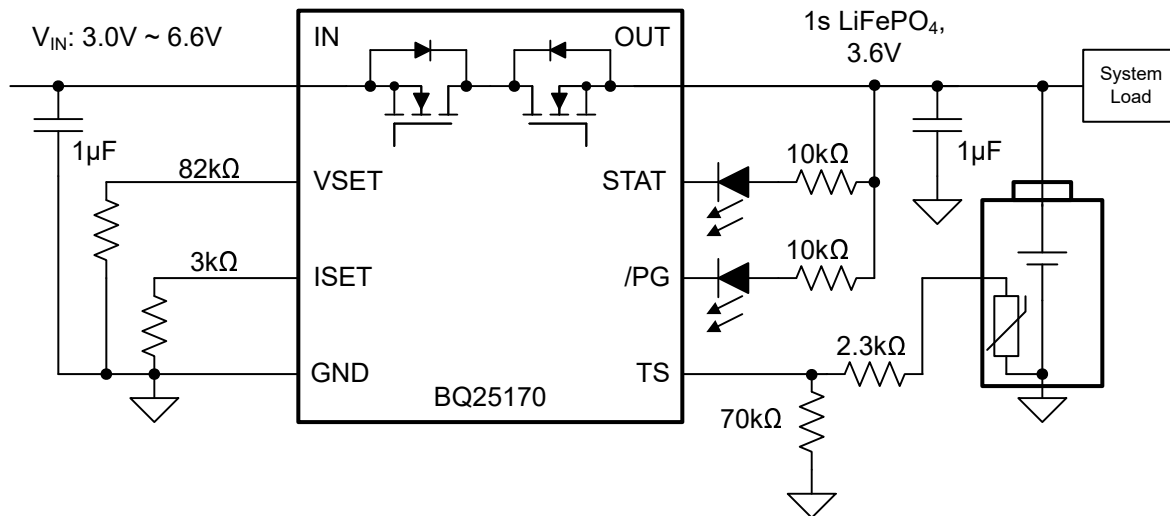

Figure 8-14. BQ25170 Typical Application for LiFePO₄ Charging at 100 mA

8.2.2.1 Design Requirements

The design requirements include the following:

- Input supply = 5 V
- Battery is 1-cell LiFePO₄
- Fast charge current: $I_{CHG} = 100 \text{ mA}$
- Charge voltage: $V_{REG} = 3.6 \text{ V}$
- Charge safety timer: $t_{SAFETY} = 10 \text{ hr}$
- Termination current: $I_{TERM} = 10\%$ of I_{CHG} or 10 mA
- Precharge current: $I_{PRECHG} = 20\%$ of I_{CHG} or 20 mA
- TS – Battery temperature sense = 10-kΩ NTC (103AT)
 - $R_S = 2.3 \text{ k}\Omega$ and $R_P = 70 \text{ k}\Omega$ added to modify battery charging temperature window to: -10°C to 60°C
- TS pin can be pulled down to disable charging

9 Power Supply Recommendations

The device is designed to operate from an input voltage supply range between 3.0 V and 6.6 V (up to 30 V tolerant) and current capability of at least the maximum designed charge current. If located more than a few inches from the IN and GND pins, a larger capacitor is recommended.

10 Layout

10.1 Layout Guidelines

To obtain optimal performance, the decoupling capacitor from IN to GND and the output filter capacitor from OUT to GND should be placed as close as possible to the device, with short trace runs to both IN, OUT and GND.

- All low-current GND connections should be kept separate from the high-current charge or discharge paths from the battery. Use a single-point ground technique incorporating both the small signal ground path and the power ground path.
- The high current charge paths into IN pin and from the OUT pin must be sized appropriately for the maximum charge current in order to avoid voltage drops in these traces.

10.2 Layout Example

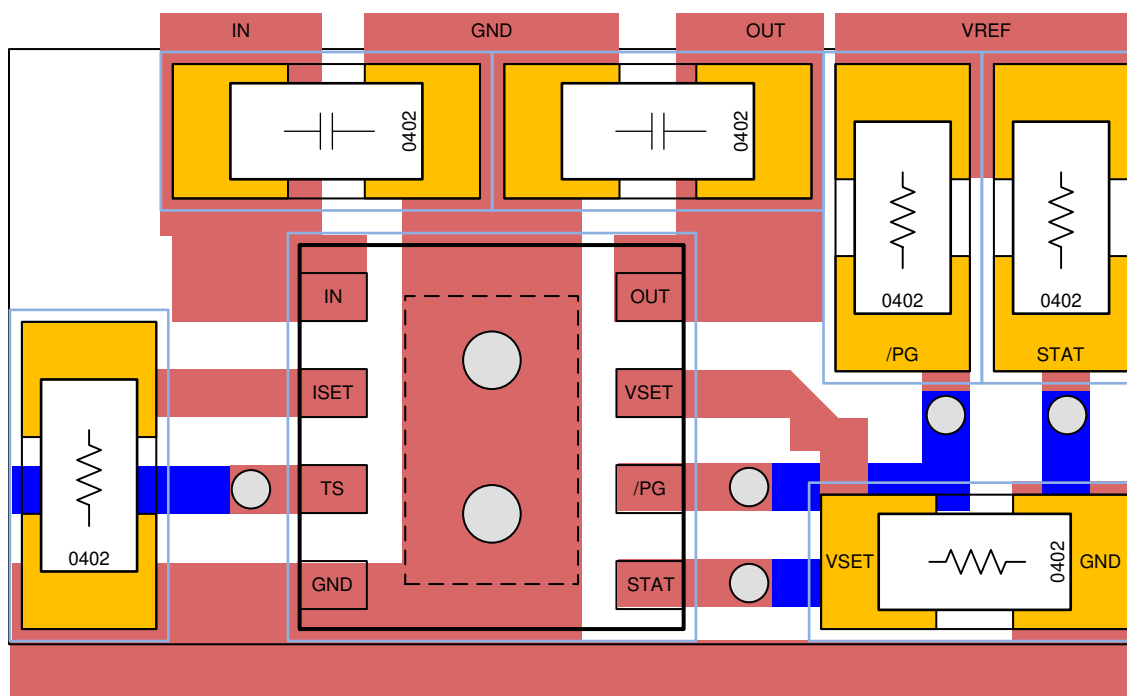

Figure 10-1. Board Layout Example

11 Device and Documentation Support

11.1 Device Support

11.1.1 Third-Party Products Disclaimer

TI'S PUBLICATION OF INFORMATION REGARDING THIRD-PARTY PRODUCTS OR SERVICES DOES NOT CONSTITUTE AN ENDORSEMENT REGARDING THE SUITABILITY OF SUCH PRODUCTS OR SERVICES OR A WARRANTY, REPRESENTATION OR ENDORSEMENT OF SUCH PRODUCTS OR SERVICES, EITHER ALONE OR IN COMBINATION WITH ANY TI PRODUCT OR SERVICE.

11.2 Receiving Notification of Documentation Updates

To receive notification of documentation updates, navigate to the device product folder on ti.com. In the upper right corner, click on *Alert me* to register and receive a weekly digest of any product information that has changed. For change details, review the revision history included in any revised document.

11.3 Support Resources

[TI E2E™ support forums](#) are an engineer's go-to source for fast, verified answers and design help — straight from the experts. Search existing answers or ask your own question to get the quick design help you need.

Linked content is provided "AS IS" by the respective contributors. They do not constitute TI specifications and do not necessarily reflect TI's views; see TI's [Terms of Use](#).

11.4 Trademarks

TI E2E™ is a trademark of Texas Instruments.

All trademarks are the property of their respective owners.

11.5 Electrostatic Discharge Caution



This integrated circuit can be damaged by ESD. Texas Instruments recommends that all integrated circuits be handled with appropriate precautions. Failure to observe proper handling and installation procedures can cause damage.

ESD damage can range from subtle performance degradation to complete device failure. Precision integrated circuits may be more susceptible to damage because very small parametric changes could cause the device not to meet its published specifications.

11.6 Glossary

[TI Glossary](#) This glossary lists and explains terms, acronyms, and definitions.

12 Mechanical, Packaging, and Orderable Information

The following pages include mechanical, packaging, and orderable information. This information is the most current data available for the designated devices. This data is subject to change without notice and revision of this document. For browser-based versions of this data sheet, refer to the left-hand navigation.

PACKAGING INFORMATION

Orderable Device	Status (1)	Package Type	Package Drawing	Pins	Package Qty	Eco Plan (2)	Lead finish/ Ball material (6)	MSL Peak Temp (3)	Op Temp (°C)	Device Marking (4/5)	Samples
BQ25170DSGR	ACTIVE	WSON	DSG	8	3000	RoHS & Green	NIPDAU	Level-2-260C-1 YEAR	-40 to 125	B170	

(1) The marketing status values are defined as follows:

ACTIVE: Product device recommended for new designs.

LIFEBUY: TI has announced that the device will be discontinued, and a lifetime-buy period is in effect.

NRND: Not recommended for new designs. Device is in production to support existing customers, but TI does not recommend using this part in a new design.

PREVIEW: Device has been announced but is not in production. Samples may or may not be available.

OBSOLETE: TI has discontinued the production of the device.

(2) **RoHS:** TI defines "RoHS" to mean semiconductor products that are compliant with the current EU RoHS requirements for all 10 RoHS substances, including the requirement that RoHS substance do not exceed 0.1% by weight in homogeneous materials. Where designed to be soldered at high temperatures, "RoHS" products are suitable for use in specified lead-free processes. TI may reference these types of products as "Pb-Free".

RoHS Exempt: TI defines "RoHS Exempt" to mean products that contain lead but are compliant with EU RoHS pursuant to a specific EU RoHS exemption.

Green: TI defines "Green" to mean the content of Chlorine (Cl) and Bromine (Br) based flame retardants meet JS709B low halogen requirements of <=1000ppm threshold. Antimony trioxide based flame retardants must also meet the <=1000ppm threshold requirement.

(3) MSL, Peak Temp. - The Moisture Sensitivity Level rating according to the JEDEC industry standard classifications, and peak solder temperature.

(4) There may be additional marking, which relates to the logo, the lot trace code information, or the environmental category on the device.

(5) Multiple Device Markings will be inside parentheses. Only one Device Marking contained in parentheses and separated by a "-" will appear on a device. If a line is indented then it is a continuation of the previous line and the two combined represent the entire Device Marking for that device.

(6) Lead finish/Ball material - Orderable Devices may have multiple material finish options. Finish options are separated by a vertical ruled line. Lead finish/Ball material values may wrap to two lines if the finish value exceeds the maximum column width.

Important Information and Disclaimer: The information provided on this page represents TI's knowledge and belief as of the date that it is provided. TI bases its knowledge and belief on information provided by third parties, and makes no representation or warranty as to the accuracy of such information. Efforts are underway to better integrate information from third parties. TI has taken and continues to take reasonable steps to provide representative and accurate information but may not have conducted destructive testing or chemical analysis on incoming materials and chemicals. TI and TI suppliers consider certain information to be proprietary, and thus CAS numbers and other limited information may not be available for release.

In no event shall TI's liability arising out of such information exceed the total purchase price of the TI part(s) at issue in this document sold by TI to Customer on an annual basis.

TAPE AND REEL INFORMATION

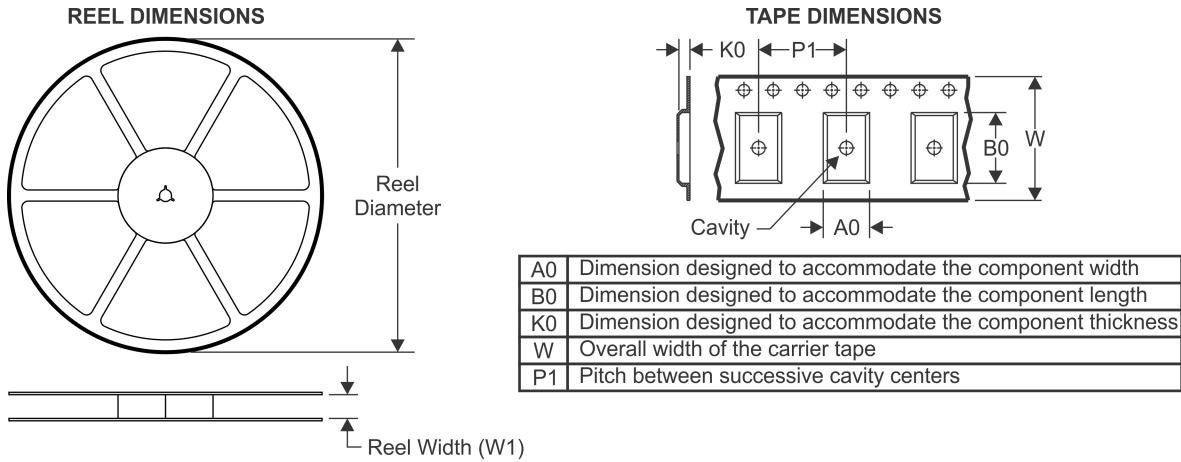

QUADRANT ASSIGNMENTS FOR PIN 1 ORIENTATION IN TAPE

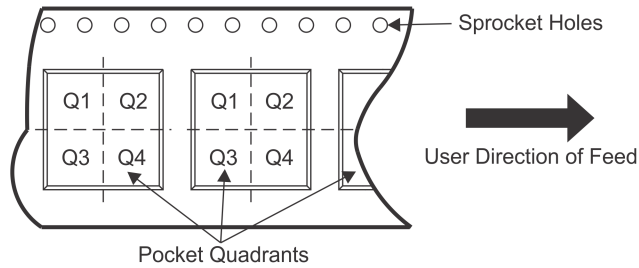

*All dimensions are nominal

Device	Package Type	Package Drawing	Pins	SPQ	Reel Diameter (mm)	Reel Width W1 (mm)	A0 (mm)	B0 (mm)	K0 (mm)	P1 (mm)	W (mm)	Pin1 Quadrant
BQ25170DSGR	WSON	DSG	8	3000	180.0	8.4	2.3	2.3	1.15	4.0	8.0	Q2

PACKAGE MATERIALS INFORMATION

17-Apr-2021

TAPE AND REEL BOX DIMENSIONS

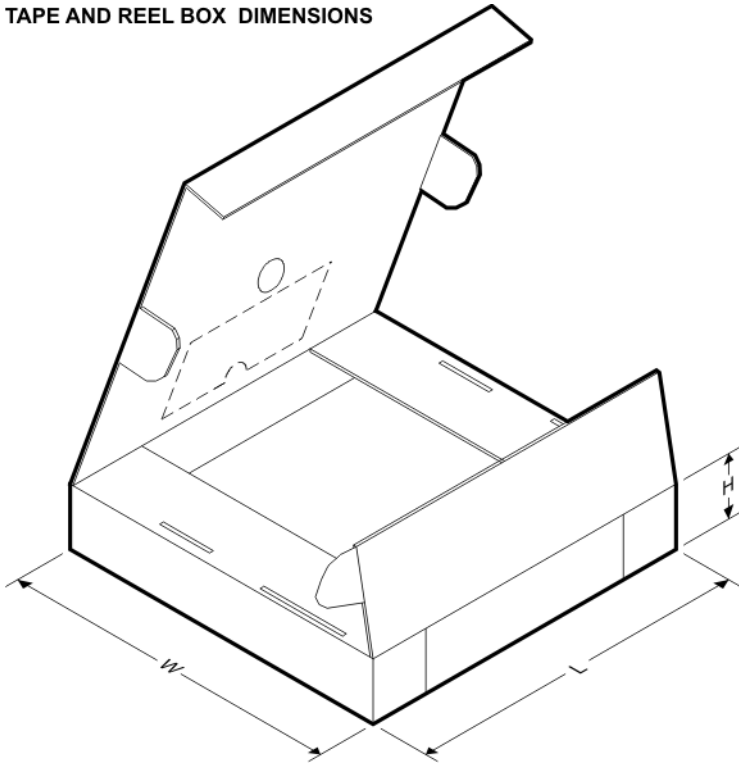

*All dimensions are nominal

Device	Package Type	Package Drawing	Pins	SPQ	Length (mm)	Width (mm)	Height (mm)
BQ25170DSGR	WSON	DSG	8	3000	210.0	185.0	35.0

GENERIC PACKAGE VIEW

DSG 8

WSON - 0.8 mm max height

2 x 2, 0.5 mm pitch

PLASTIC SMALL OUTLINE - NO LEAD

This image is a representation of the package family, actual package may vary.
Refer to the product data sheet for package details.



DSG0008A

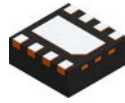

PACKAGE OUTLINE
WSON - 0.8 mm max height

PLASTIC SMALL OUTLINE - NO LEAD

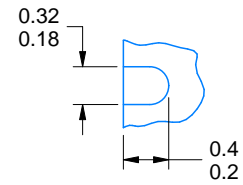
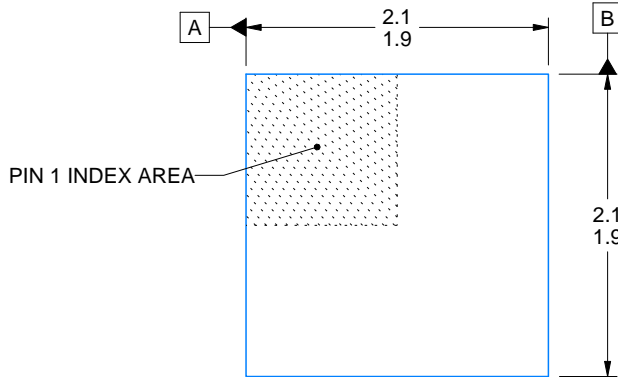

ALTERNATIVE TERMINAL SHAPE
 TYPICAL

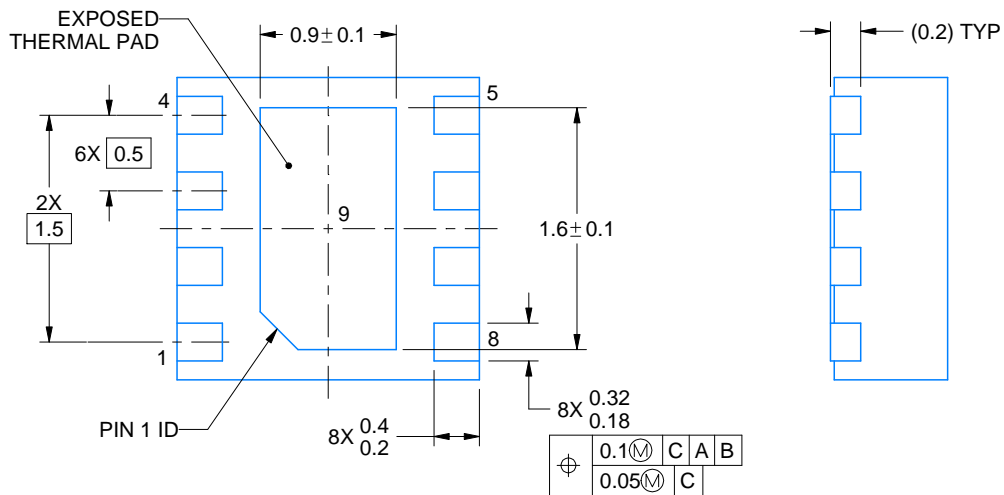
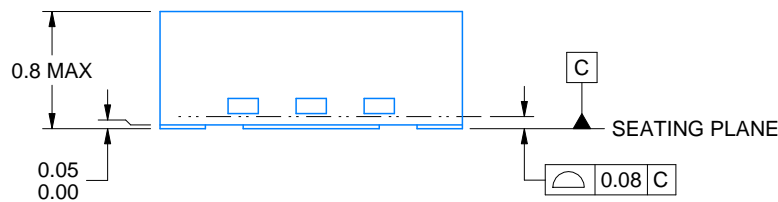

4218900/D 04/2020

NOTES:

1. All linear dimensions are in millimeters. Any dimensions in parenthesis are for reference only. Dimensioning and tolerancing per ASME Y14.5M.
2. This drawing is subject to change without notice.
3. The package thermal pad must be soldered to the printed circuit board for thermal and mechanical performance.

EXAMPLE BOARD LAYOUT

DSG0008A

WSON - 0.8 mm max height

PLASTIC SMALL OUTLINE - NO LEAD

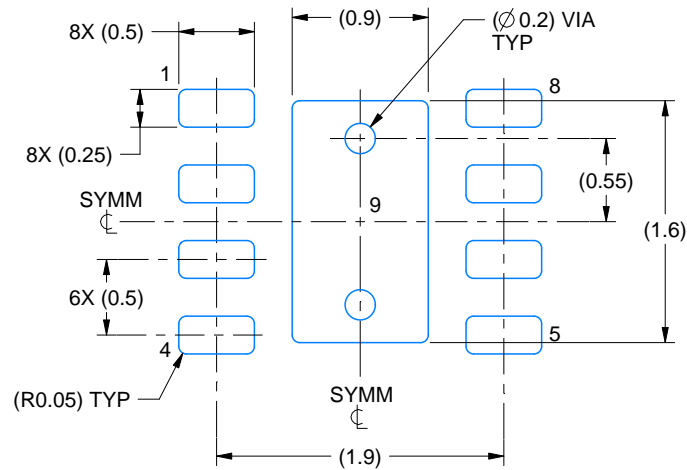

LAND PATTERN EXAMPLE
SCALE:20X

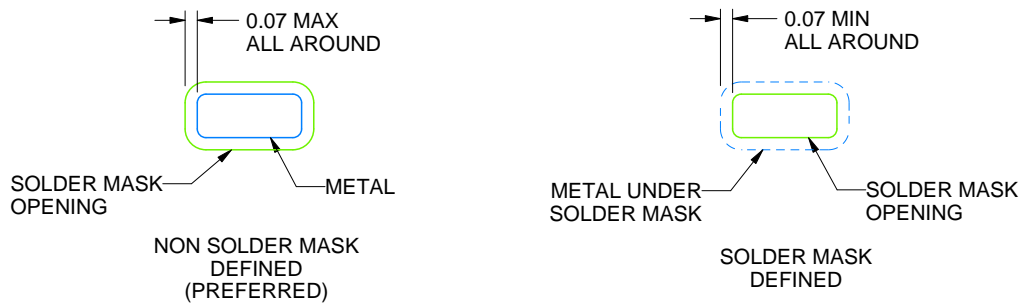

SOLDER MASK DETAILS

4218900/D 04/2020

NOTES: (continued)

4. This package is designed to be soldered to a thermal pad on the board. For more information, see Texas Instruments literature number SLUA271 (www.ti.com/lit/slua271).
5. Vias are optional depending on application, refer to device data sheet. If any vias are implemented, refer to their locations shown on this view. It is recommended that vias under paste be filled, plugged or tented.

EXAMPLE STENCIL DESIGN

DSG0008A

WSON - 0.8 mm max height

PLASTIC SMALL OUTLINE - NO LEAD

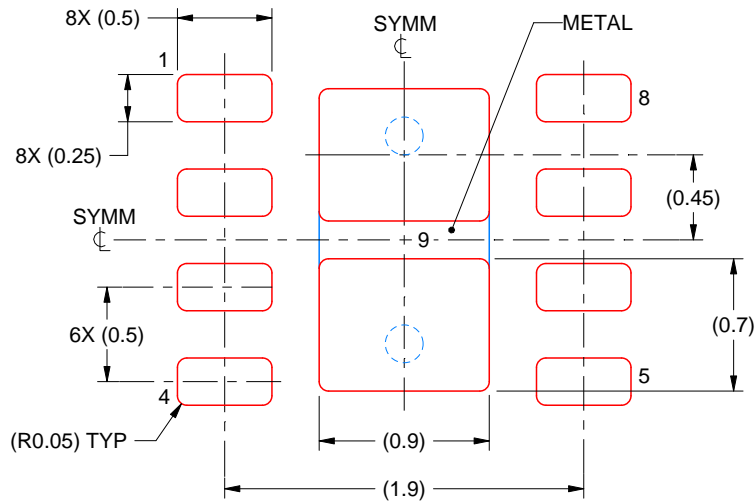

SOLDER PASTE EXAMPLE
BASED ON 0.125 mm THICK STENCIL

EXPOSED PAD 9:
87% PRINTED SOLDER COVERAGE BY AREA UNDER PACKAGE
SCALE:25X

4218900/D 04/2020

NOTES: (continued)

6. Laser cutting apertures with trapezoidal walls and rounded corners may offer better paste release. IPC-7525 may have alternate design recommendations.

IMPORTANT NOTICE AND DISCLAIMER

TI PROVIDES TECHNICAL AND RELIABILITY DATA (INCLUDING DATASHEETS), DESIGN RESOURCES (INCLUDING REFERENCE DESIGNS), APPLICATION OR OTHER DESIGN ADVICE, WEB TOOLS, SAFETY INFORMATION, AND OTHER RESOURCES "AS IS" AND WITH ALL FAULTS, AND DISCLAIMS ALL WARRANTIES, EXPRESS AND IMPLIED, INCLUDING WITHOUT LIMITATION ANY IMPLIED WARRANTIES OF MERCHANTABILITY, FITNESS FOR A PARTICULAR PURPOSE OR NON-INFRINGEMENT OF THIRD PARTY INTELLECTUAL PROPERTY RIGHTS.

These resources are intended for skilled developers designing with TI products. You are solely responsible for (1) selecting the appropriate TI products for your application, (2) designing, validating and testing your application, and (3) ensuring your application meets applicable standards, and any other safety, security, or other requirements. These resources are subject to change without notice. TI grants you permission to use these resources only for development of an application that uses the TI products described in the resource. Other reproduction and display of these resources is prohibited. No license is granted to any other TI intellectual property right or to any third party intellectual property right. TI disclaims responsibility for, and you will fully indemnify TI and its representatives against, any claims, damages, costs, losses, and liabilities arising out of your use of these resources.

TI's products are provided subject to TI's Terms of Sale (or other applicable terms available either on rovided in conjunction with such TI products. TI's provision of these resources does not expand or otherwise alter TI's applicable warranties or warranty disclaimers for TI products.

Mailing Address: Texas Instruments, Post Office Box 655303, Dallas, Texas 75265
Copyright © 2021, Texas Instruments Incorporated