

SGM4040

Micro-Power Precision Shunt Voltage Reference

GENERAL DESCRIPTION

The SGM4040 is a micro-power, precision shunt voltage reference which is easy to use in many applications. It has a fixed output voltage of 2.5V, and draws operating current up to 15mA. The device has no need for external capacitors and can keep stable with any capacitive load.

The SGM4040 features low temperature coefficient, low output noise, and low dynamic impedance. These characteristics enable the device to output stable voltage over a wide operating temperature and current range.

The SGM4040 offers high accuracy of 0.3% (MAX) for B grade and 0.5% (MAX) for C grade.

The SGM4040 is available in Green SOT-23 and SC70-5 packages. It operates over an ambient temperature range of -40°C to +125°C.

FEATURES

- **Fixed Output Voltage: 2.5V**
- **Wide Operating Current Range: 48 μ A to 15mA (TYP)**
- **Output Voltage Accuracy:**
 - ◆ **SGM4040B: 0.3% (MAX)**
 - ◆ **SGM4040C: 0.5% (MAX)**
- **Low Temperature Coefficient: 20ppm/°C (TYP)**
- **Low Output Noise: 20 μ V_{RMS} (TYP)**
- **Stable without External Capacitors**
- **Stable with Any Capacitive Load**
- **-40°C to +125°C Operating Temperature Range**
- **Available in Green SOT-23 and SC70-5 Packages**

APPLICATIONS

Precision Data-Acquisition Systems
Instrumentation and Test Equipment
Industrial Process Controls
Precision Audio Components
Power Management
Battery-Powered Equipment

TYPICAL APPLICATION

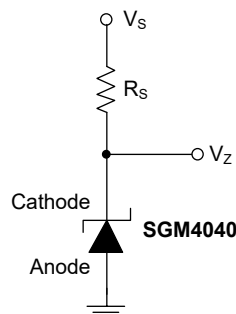
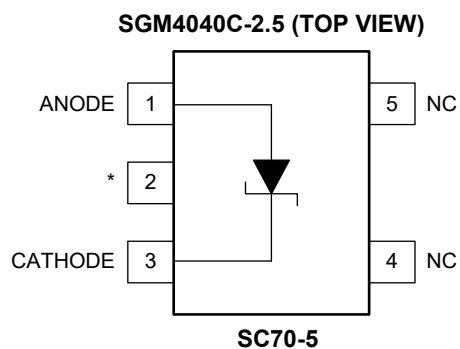
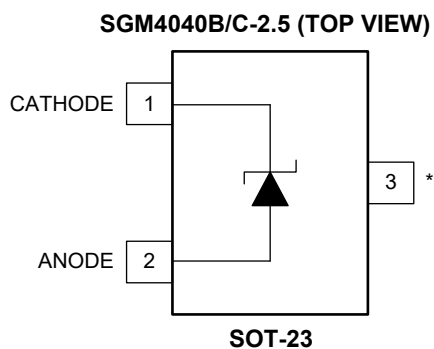

Figure 1. Shunt Regulator Simplified Schematic

PIN CONFIGURATIONS



PIN DESCRIPTION

PIN		NAME	I/O	FUNCTION
SOT-23	SC70-5			
1	3	CATHODE	I/O	Cathode Pin. Shunt current and output voltage.
2	1	ANODE	O	Anode Pin. Connect to GND directly.
3	2	*	—	Must be connected to ANODE pin or left floating.
—	4, 5	NC	—	Not Connected.

SGM4040B-2.5 ELECTRICAL CHARACTERISTICS(Full = -40°C to +125°C, typical values are at $T_A = +25^\circ\text{C}$, unless otherwise noted.)

PARAMETER	SYMBOL	CONDITIONS	TEMP	MIN	TYP	MAX	UNITS
Reverse Breakdown Voltage	V_Z	$I_Z = 100\mu\text{A}$	+25°C		2.5		V
Reverse Breakdown Voltage Tolerance		$I_Z = 100\mu\text{A}$	+25°C	-7.5		7.5	mV
			Full	-20.5		20.5	
Minimum Cathode Current	$I_{Z(\text{MIN})}$		+25°C		48	75	μA
			Full			95	
Average Temperature Coefficient of Reverse Breakdown Voltage	αV_Z	$I_Z = 10\text{mA}$	Full		20		ppm/°C
		$I_Z = 1\text{mA}$	Full		20		
		$I_Z = 100\mu\text{A}$	Full		20		
Reverse Breakdown Voltage Change with Cathode Current Change	$\Delta V_Z/\Delta I_Z$	$I_{Z(\text{MIN})} < I_Z < 1\text{mA}$	+25°C		1.4	4	mV
			Full			7.5	
		$1\text{mA} < I_Z < 15\text{mA}$	+25°C		2.6	4.5	
			Full			6.5	
Reverse Dynamic Impedance	Z_Z	$I_Z = 1\text{mA}, I_{AC} = 0.5I_Z$	+25°C		0.6	1.5	Ω
			Full			2.5	
Wideband Noise	e_n	$I_Z = 100\mu\text{A}, 10\text{Hz} \leq f \leq 10\text{kHz}$	+25°C		20		μV_{RMS}
Thermal Hysteresis ⁽¹⁾	V_{HYST}	$\Delta T_A = -40^\circ\text{C}$ to $+125^\circ\text{C}$			0.05		%

SGM4040C-2.5 ELECTRICAL CHARACTERISTICS(Full = -40°C to +125°C, typical values are at $T_A = +25^\circ\text{C}$, unless otherwise noted.)

PARAMETER	SYMBOL	CONDITIONS	TEMP	MIN	TYP	MAX	UNITS
Reverse Breakdown Voltage	V_Z	$I_Z = 100\mu\text{A}$	+25°C		2.5		V
Reverse Breakdown Voltage Tolerance		$I_Z = 100\mu\text{A}$	+25°C	-12.5		12.5	mV
			Full	-25		25	
Minimum Cathode Current	$I_{Z(\text{MIN})}$		+25°C		48	75	μA
			Full			95	
Average Temperature Coefficient of Reverse Breakdown Voltage	αV_Z	$I_Z = 10\text{mA}$	Full		20		ppm/°C
		$I_Z = 1\text{mA}$	Full		20		
		$I_Z = 100\mu\text{A}$	Full		20		
Reverse Breakdown Voltage Change with Cathode Current Change	$\Delta V_Z/\Delta I_Z$	$I_{Z(\text{MIN})} < I_Z < 1\text{mA}$	+25°C		1.4	4	mV
			Full			7.5	
		$1\text{mA} < I_Z < 15\text{mA}$	+25°C		2.6	4.5	
			Full			6.5	
Reverse Dynamic Impedance	Z_Z	$I_Z = 1\text{mA}, I_{AC} = 0.5I_Z$	+25°C		0.6	1.5	Ω
			Full			2.5	
Wideband Noise	e_n	$I_Z = 100\mu\text{A}, 10\text{Hz} \leq f \leq 10\text{kHz}$	+25°C		20		μV_{RMS}
Thermal Hysteresis ⁽¹⁾	V_{HYST}	$\Delta T_A = -40^\circ\text{C}$ to $+125^\circ\text{C}$			0.05		%

NOTE: 1. Thermal hysteresis is defined as the output voltage difference at the +25°C after a temperature excursion to -40°C, then to +125°C, and back to +25°C.

TYPICAL PERFORMANCE CHARACTERISTICS

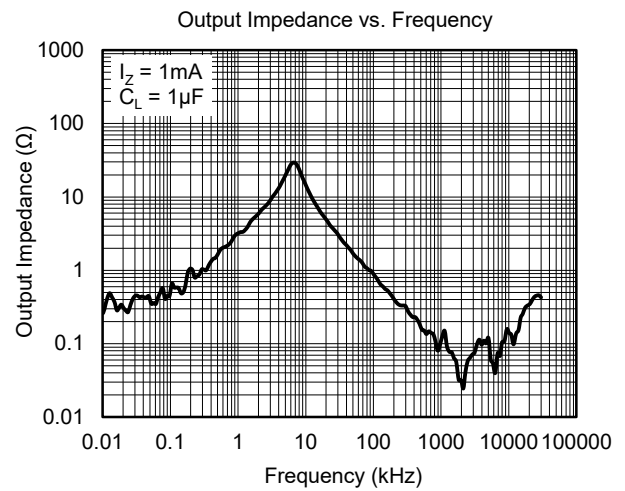
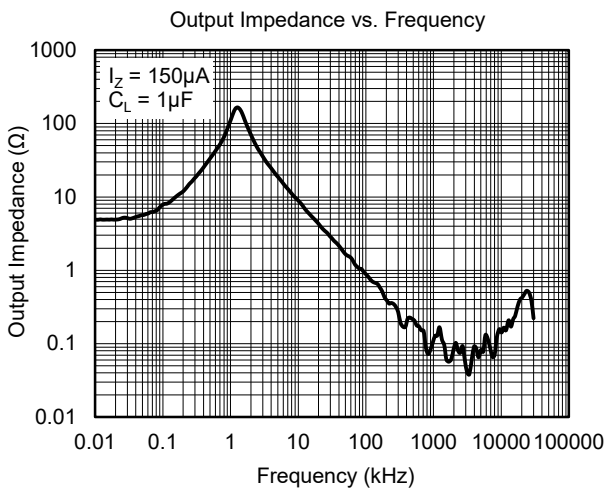
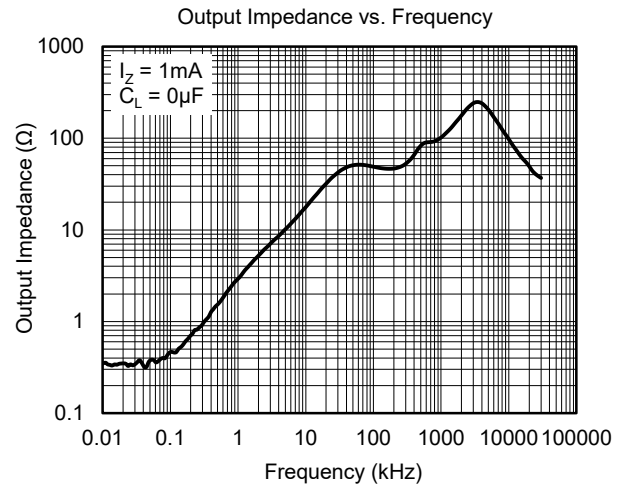
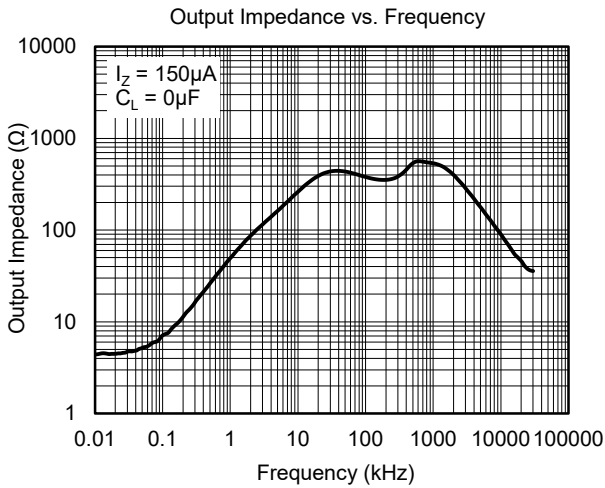
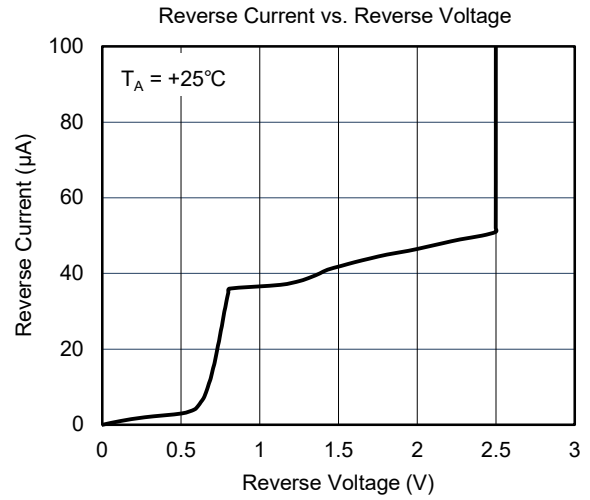
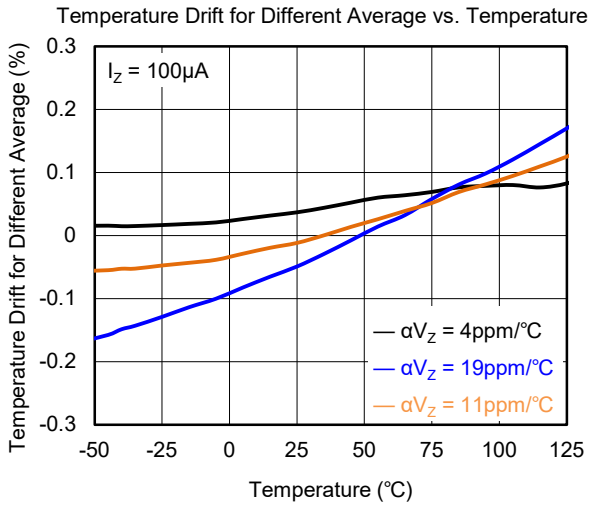

TYPICAL PERFORMANCE CHARACTERISTICS (continued)

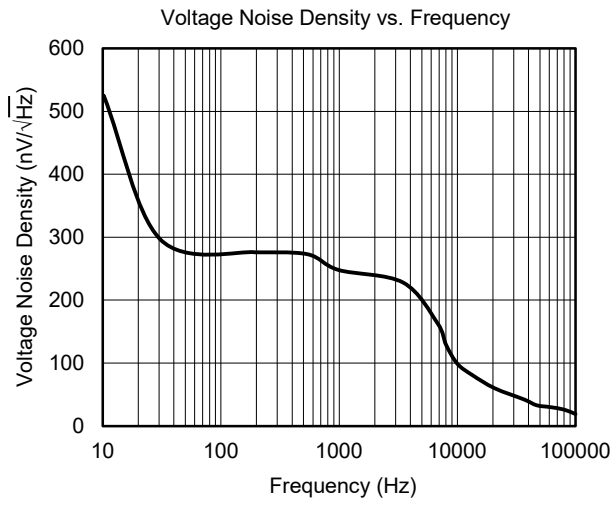

DETAILED DESCRIPTION

SGM4040 is a micro-power, high precision, small-footprint, fixed-voltage shunt voltage reference.

Feature Description

For SGM4040, the precision level of this Zener diode is significant. For the regulation of SGM4040, the required quiescent current for this device is low. Also, shunting the load current to the ground is one method to regulate and it depends on the load resistance and level of input voltage. For operating SGM4040, an external resistor between the cathode and power supply is required for setting the input current. For getting lower noise, an external capacitor is also recommended to filter the noise at the input and output pins of the precision Zener diode.

Device Functional Modes

The output of SGM4040 is fixed and non-adjustable, which means there is a feedback loop inside the device and the Zener diode operates in the closed-loop mode. Also, the device will work typically if I_Z is between the range of I_{ZMIN} and I_{ZMAX} , so a proper selection of external resistor is important to make sure that the load and cathode current are within the typical range.

APPLICATION INFORMATION

The SGM4040 is designed to provide a voltage reference accurately with ultra-low power dissipation. For the application of critical-space system, the sub-miniature packages (SOT-23 and SC70-5) can be selected. Because of the excellent stability of the shunt voltage reference, the capacitors are not required to be connected between CATHODE and ANODE pins. However, if a bypass capacitor is required, the stability of SGM4040 will not be reduced. For SGM4040, the typical cathode current is 48uA to 15mA, and the reversed breakdown voltage is 2.5V.

Between ANODE pin and CATHODE pin is a parasitic Schottky diode. Therefore, leaving * pin (pin 3 of SOT-23 package or pin 2 of SC70-5 package) floating or connected to ANODE pin is a good choice.

Load Current and Cathode

For the shunt regulator shown in Figure 2, R_S is required to be connected between V_S and the cathode of SGM4040. The value of R_S is significant for this shunt regulator because it determines how much current can be flowed to the voltage reference itself (I_Z) and the load (I_L), and the user needs to make sure that the cathode current (I_Z) is operated within the design specification. However, for one extreme case, if the supply voltage and load is varied (the load current I_L is maximum and the V_S is minimum), it is recommended that the resistance of R_S should be selected low enough to guarantee normal operation of the shunt regulator. For the other extreme, I_L is minimum and V_S is maximum, the resistance of R_S should be large enough to guarantee that the operating current I_Z is less than 15mA.

The equation 1 shows the calculation of R_S .

$$R_S = \frac{V_S - V_Z}{I_L + I_Z} \quad (1)$$

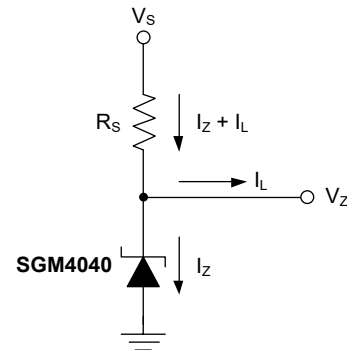

Figure 2. Shunt Regulator

Thermal Hysteresis

The definition of thermal hysteresis is the voltage change at +25°C after thermal cycling to -40°C and +125°C respectively. To explain, first finish thermal cycling at -40°C, then measure the output voltage after moving the device into the condition of +25°C. Second, finish thermal cycling at +125°C and then measure the output voltage at +25°C. The difference of the output voltage at these two testing conditions is the thermal hysteresis. The thermal hysteresis is common for the precision device because of the stress of thermal-mechanical package. Also, thermal hysteresis will be contributed by temperature of mounting, operating and storing.

REVISION HISTORY

NOTE: Page numbers for previous revisions may differ from page numbers in the current version.

Changes from Original (MARCH 2022) to REV.A	Page
Changed from product preview to production data.....	All

PACKAGE INFORMATION

PACKAGE OUTLINE DIMENSIONS

SOT-23

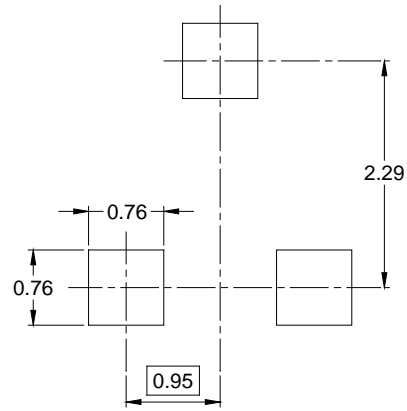
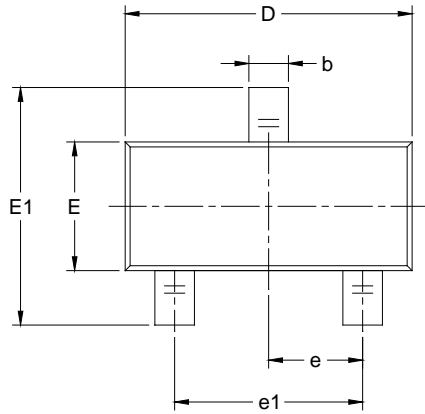

RECOMMENDED LAND PATTERN (Unit: mm)

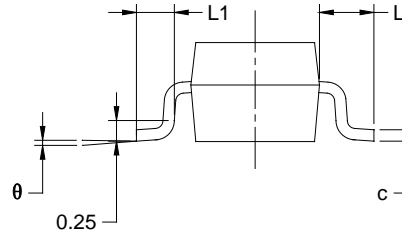
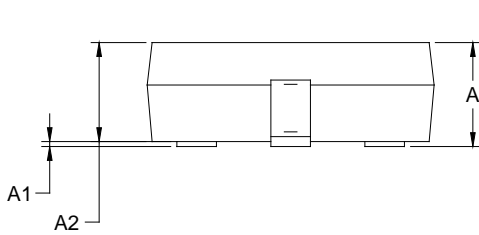

Symbol	Dimensions In Millimeters		Dimensions In Inches	
	MIN	MAX	MIN	MAX
A	0.89	1.12	0.035	0.044
A1	0.01	0.10	0.000	0.004
A2	0.88	1.02	0.035	0.040
b	0.30	0.50	0.012	0.020
c	0.08	0.20	0.003	0.008
D	2.80	3.04	0.110	0.120
E	1.20	1.40	0.047	0.055
E1	2.10	2.64	0.083	0.104
e	0.95 BSC		0.037 BSC	
e1	1.90 BSC		0.075 BSC	
L	0.54 REF		0.021 REF	
L1	0.40	0.60	0.016	0.024
θ	0°	8°	0°	8°

NOTES:

1. Body dimensions do not include mold flash or protrusion.
2. This drawing is subject to change without notice.

PACKAGE INFORMATION

PACKAGE OUTLINE DIMENSIONS

SC70-5

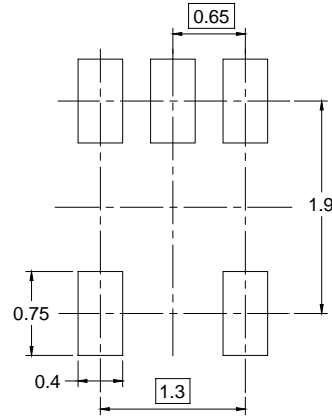
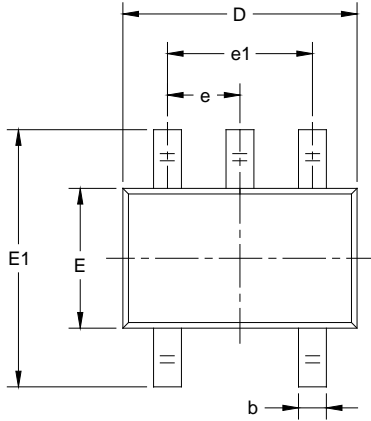

RECOMMENDED LAND PATTERN (Unit: mm)

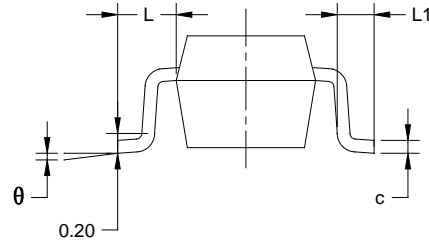
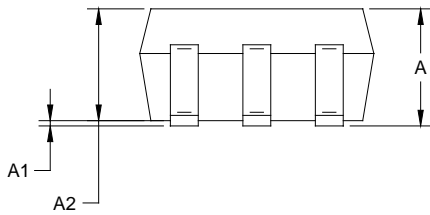

Symbol	Dimensions In Millimeters		Dimensions In Inches	
	MIN	MAX	MIN	MAX
A	0.800	1.100	0.031	0.043
A1	0.000	0.100	0.000	0.004
A2	0.800	1.000	0.031	0.039
b	0.150	0.350	0.006	0.014
c	0.080	0.220	0.003	0.009
D	2.000	2.200	0.079	0.087
E	1.150	1.350	0.045	0.053
E1	2.150	2.450	0.085	0.096
e	0.65 TYP		0.026 TYP	
e1	1.300 BSC		0.051 BSC	
L	0.525 REF		0.021 REF	
L1	0.260	0.460	0.010	0.018
θ	0°	8°	0°	8°

NOTES:

1. Body dimensions do not include mode flash or protrusion.
2. This drawing is subject to change without notice.

PACKAGE INFORMATION

TAPE AND REEL INFORMATION

REEL DIMENSIONS

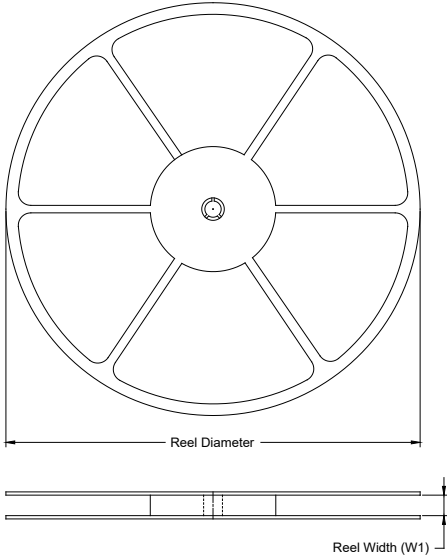

TAPE DIMENSIONS

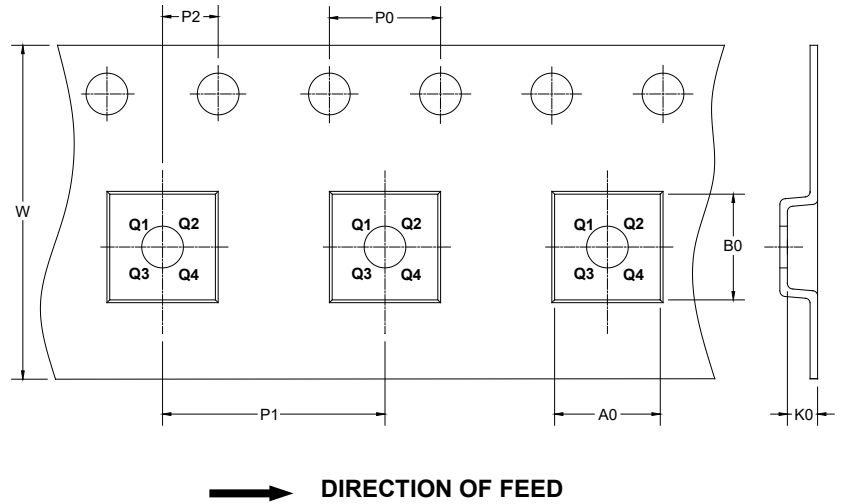

NOTE: The picture is only for reference. Please make the object as the standard.

KEY PARAMETER LIST OF TAPE AND REEL

Package Type	Reel Diameter	Reel Width W1 (mm)	A0 (mm)	B0 (mm)	K0 (mm)	P0 (mm)	P1 (mm)	P2 (mm)	W (mm)	Pin1 Quadrant
SOT-23	7"	9.5	3.15	2.77	1.22	4.0	4.0	2.0	8.0	Q3
SC70-5	7"	9.5	2.25	2.55	1.20	4.0	4.0	2.0	8.0	Q3

DD0001

PACKAGE INFORMATION

CARTON BOX DIMENSIONS



NOTE: The picture is only for reference. Please make the object as the standard.

KEY PARAMETER LIST OF CARTON BOX

Reel Type	Length (mm)	Width (mm)	Height (mm)	Pizza/Carton
7" (Option)	368	227	224	8
7"	442	410	224	18

DD0002