

# SGM8270-2

## Low Noise, Precision, High Voltage, Rail-to-Rail I/O Operational Amplifier

---

### GENERAL DESCRIPTION

The SGM8270-2 is a low noise, precision, high voltage dual operational amplifier which is designed to offer a wide input common mode voltage range and output voltage swing. The device can operate from  $\pm 1.65\text{V}$  to  $\pm 18\text{V}$  dual power supplies or from  $3.3\text{V}$  to  $36\text{V}$  single supply.

The device features low noise, high slew rate, low input bias and offset current, and low offset voltage.

The SGM8270-2 is available in Green SOIC-8 and MSOP-8 packages. It is specified over the extended  $-40^\circ\text{C}$  to  $+125^\circ\text{C}$  temperature range.

### FEATURES

- **Wide Input Common Mode and Differential Voltage Ranges**
- **Low Input Bias and Offset Current**
- **Output Short-Circuit Protection**
- **Rail-to-Rail Input and Output**
- **High Input Impedance**
- **Low Offset Voltage: 2.8mV (MAX)**
- **Low Noise:  $15\text{nV}/\sqrt{\text{Hz}}$  at 1kHz**
- **Gain-Bandwidth Product: 2.5MHz**
- **High Slew Rate:  $8\text{V}/\mu\text{s}$**
- **$-40^\circ\text{C}$  to  $+125^\circ\text{C}$  Operating Temperature Range**
- **Available in Green SOIC-8 and MSOP-8 Packages**

### APPLICATIONS

High Impedance Sensor  
Photodiode Amplifier  
High End, Professional Audio  
DAC Output Amplifier  
Medical

**PACKAGE/ORDERING INFORMATION**

MODEL	PACKAGE DESCRIPTION	SPECIFIED TEMPERATURE RANGE	ORDERING NUMBER	PACKAGE MARKING	PACKING OPTION
SGM8270-2	SOIC-8	-40°C to +125°C	SGM8270-2XS8G/TR	SGM 82702XS8 XXXXX	Tape and Reel, 4000
	MSOP-8	-40°C to +125°C	SGM8270-2XMS8G/TR	SGM82702 XMS8 XXXXX	Tape and Reel, 4000

**MARKING INFORMATION**

NOTE: XXXXX = Date Code and Vendor Code.

**XXXXX**

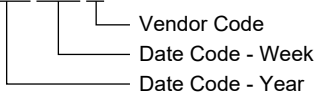

Green (RoHS & HSF): SG Micro Corp defines "Green" to mean Pb-Free (RoHS compatible) and free of halogen substances. If you have additional comments or questions, please contact your SGMICRO representative directly.

**ABSOLUTE MAXIMUM RATINGS**

Supply Voltage, +Vs to -Vs..... 40V  
 Input/Output Voltage Range.....(-Vs) - 0.3V to (+Vs) + 0.3V  
 Junction Temperature.....+150°C  
 Storage Temperature Range.....-65°C to +150°C  
 Lead Temperature (Soldering, 10s).....+260°C  
 ESD Susceptibility  
 HBM.....6000V  
 MM.....400V  
 CDM .....2000V

**RECOMMENDED OPERATING CONDITIONS**

Operating Temperature Range.....-40°C to +125°C

NOTE:

1. Proper power supply sequencing is recommended for the CMOS device. Always sequence Vs on first, followed by the inputs and outputs.

**OVERSTRESS CAUTION**

Stresses beyond those listed in Absolute Maximum Ratings may cause permanent damage to the device. Exposure to absolute maximum rating conditions for extended periods may affect reliability. Functional operation of the device at any conditions beyond those indicated in the Recommended Operating Conditions section is not implied.

**ESD SENSITIVITY CAUTION**

This integrated circuit can be damaged if ESD protections are not considered carefully. SGMICRO recommends that all integrated circuits be handled with appropriate precautions. Failure to observe proper handling and installation procedures can cause damage. ESD damage can range from subtle performance degradation to complete device failure. Precision integrated circuits may be more susceptible to damage because even small parametric changes could cause the device not to meet the published specifications.

**DISCLAIMER**

SG Micro Corp reserves the right to make any change in circuit design, or specifications without prior notice.

**PIN CONFIGURATIONS**

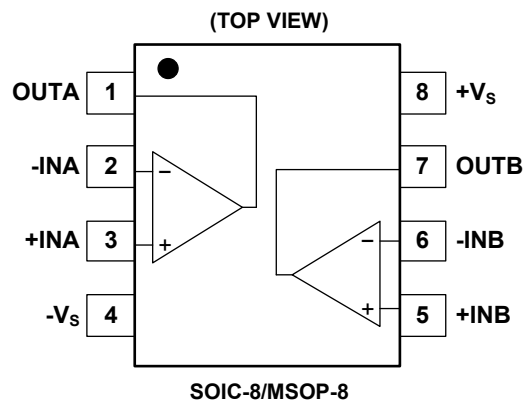

**ELECTRICAL CHARACTERISTICS**(At  $T_A = +25^\circ\text{C}$ ,  $V_S = \pm 1.65\text{V}$  to  $\pm 18\text{V}$  and  $R_L = 2\text{k}\Omega$  connected to  $0\text{V}$ , Full =  $-40^\circ\text{C}$  to  $+125^\circ\text{C}$ , unless otherwise noted.)

PARAMETER	SYMBOL	CONDITIONS	TEMP	MIN	TYP	MAX	UNITS
<b>Input Characteristics</b>							
Input Offset Voltage	$V_{OS}$	$V_{CM} = 0\text{V}$	$+25^\circ\text{C}$		1.2	2.8	mV
			Full			3	
Input Offset Voltage Drift	$\Delta V_{OS}/\Delta T$		Full		0.8		$\mu\text{V}/^\circ\text{C}$
Input Bias Current	$I_B$	$V_{CM} = 0\text{V}$	$+25^\circ\text{C}$		$\pm 10$	$\pm 300$	pA
Input Offset Current	$I_{OS}$	$V_{CM} = 0\text{V}$	$+25^\circ\text{C}$		$\pm 10$	$\pm 300$	pA
Maximum Differential Input Voltage	$ V_{ID} $		Full			$V_S$	V
Maximum Input Difference Bias Current	$ I_{ID} $	$V_S = \pm 18\text{V}$ , $V_{ID} = \pm 18\text{V}$	$+25^\circ\text{C}$		2	3	$\mu\text{A}$
			Full			4	
Input Common Mode Voltage Range	$V_{CM}$		Full	$(-V_S) - 0.1$		$(+V_S) + 0.1$	V
Common Mode Rejection Ratio	CMRR	$V_S = \pm 18\text{V}$ , $(-V_S) - 0.1\text{V} < V_{CM} < (+V_S) - 1.5\text{V}$	$+25^\circ\text{C}$	96	105		dB
			Full	93			
		$V_S = \pm 18\text{V}$ , $(-V_S) - 0.1\text{V} < V_{CM} < (+V_S) + 0.1\text{V}$	$+25^\circ\text{C}$	76	85		
			Full	73			
Open-Loop Voltage Gain	$A_{OL}$	$(-V_S) + 0.2\text{V} < V_{OUT} < (+V_S) - 0.2\text{V}$ , $R_L = 10\text{k}\Omega$	$+25^\circ\text{C}$	103	120		dB
			Full	100			
		$(-V_S) + 0.5\text{V} < V_{OUT} < (+V_S) - 0.5\text{V}$ , $R_L = 2\text{k}\Omega$	$+25^\circ\text{C}$	100	120		
			Full	87			
<b>Output Characteristics</b>							
Output Voltage Swing from Rail	$V_{OUT}$	$V_S = \pm 18\text{V}$ , $R_L = 10\text{k}\Omega$	$+25^\circ\text{C}$		60	80	mV
			Full			110	
		$V_S = \pm 18\text{V}$ , $R_L = 2\text{k}\Omega$	$+25^\circ\text{C}$		300	400	
			Full			540	
Output Short-Circuit Current	$I_{SC}$	$V_S = \pm 18\text{V}$	$+25^\circ\text{C}$	$\pm 28$	$\pm 40$		mA
<b>Power Supply</b>							
Operating Voltage Range	$V_S$		Full	3.3		36	V
Quiescent Current	$I_Q$	$I_{OUT} = 0$	$+25^\circ\text{C}$		1	1.24	mA
			Full			1.5	
Power Supply Rejection Ratio	PSRR	$V_S = 3.3\text{V}$ to $36\text{V}$	$+25^\circ\text{C}$	106	120		dB
			Full	103			
<b>Dynamic Performance</b>							
Gain-Bandwidth Product	GBP	$C_L = 50\text{pF}$	$+25^\circ\text{C}$		2.5		MHz
Phase Margin	$\phi_O$	$C_L = 50\text{pF}$	$+25^\circ\text{C}$		60		$^\circ$
Slew Rate	SR	$V_S = \pm 2.5\text{V}$ to $\pm 18\text{V}$ , $G = +1$	$+25^\circ\text{C}$		8		$\text{V}/\mu\text{s}$
Overload Recovery Time	ORT	$V_{IN} \times G > V_S$	$+25^\circ\text{C}$		1		$\mu\text{s}$
Total Harmonic Distortion + Noise	THD+N	$V_S = \pm 2.5\text{V}$ to $\pm 18\text{V}$ , $V_{OUT} = 2V_{P-P}$ , $f = 1\text{kHz}$ , $G = +1$ , $R_L = 600\Omega$	$+25^\circ\text{C}$		0.005		%
			$+25^\circ\text{C}$		0.0005		%
<b>Noise</b>							
Input Voltage Noise		$f = 0.1\text{Hz}$ to $10\text{Hz}$	$+25^\circ\text{C}$		3		$\mu\text{V}_{P-P}$
Input Voltage Noise Density	$e_n$	$f = 10\text{Hz}$	$+25^\circ\text{C}$		100		$\text{nV}/\sqrt{\text{Hz}}$
		$f = 1\text{kHz}$	$+25^\circ\text{C}$		15		
Input Current Noise Density	$i_n$	$f = 1\text{kHz}$	$+25^\circ\text{C}$		300		$\text{fA}/\sqrt{\text{Hz}}$

**TYPICAL PERFORMANCE CHARACTERISTICS**

At  $T_A = +25^\circ\text{C}$ ,  $V_S = 36\text{V}$  and  $R_L = 2\text{k}\Omega$ , unless otherwise noted.

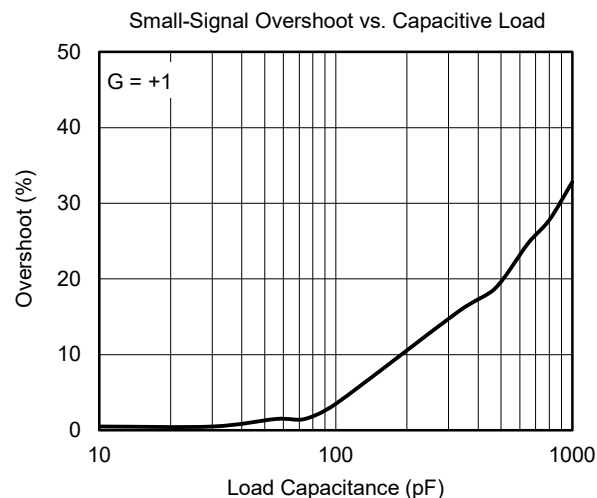
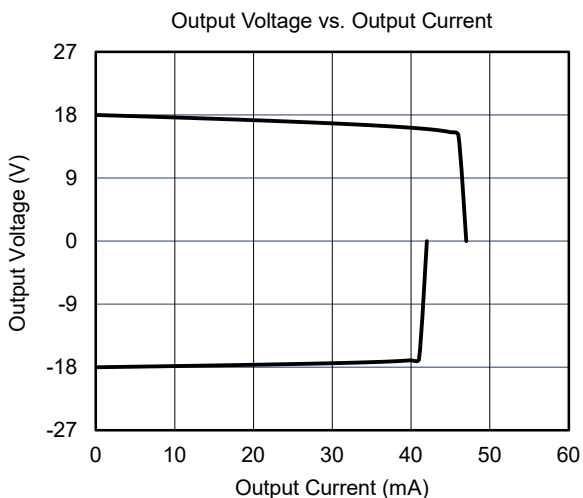
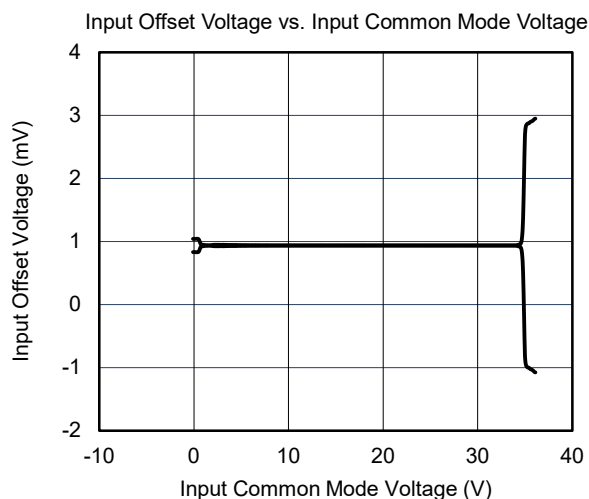
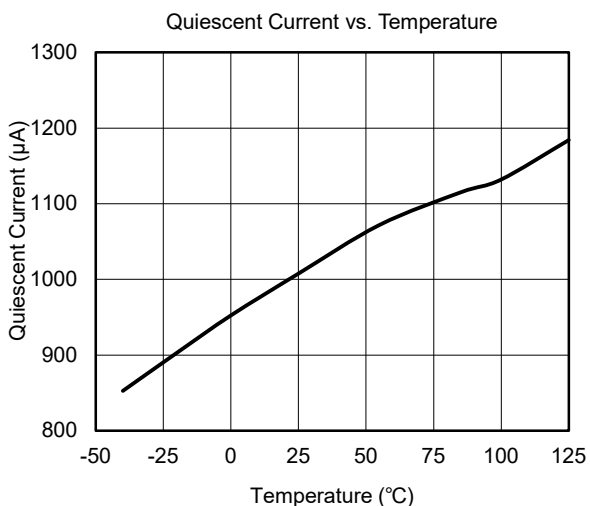
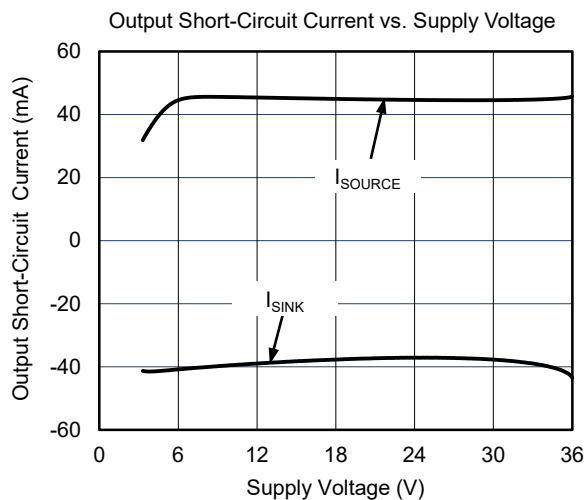
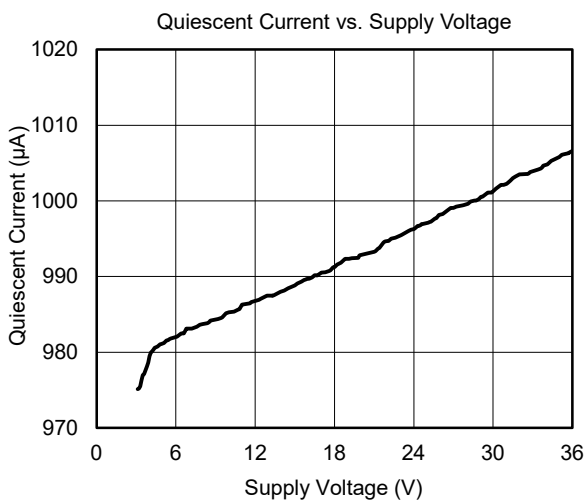

**TYPICAL PERFORMANCE CHARACTERISTICS (continued)**

At  $T_A = +25^\circ\text{C}$ ,  $V_S = 36\text{V}$  and  $R_L = 2\text{k}\Omega$ , unless otherwise noted.

Large-Signal Step Response

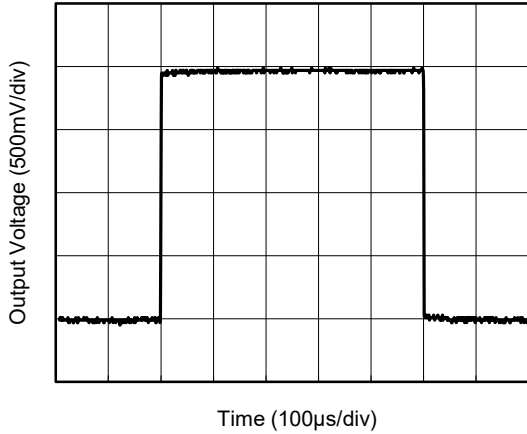

Small-Signal Step Response

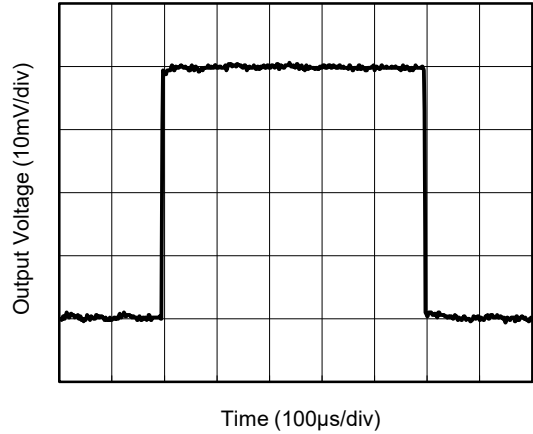

CMRR and PSRR vs. Frequency

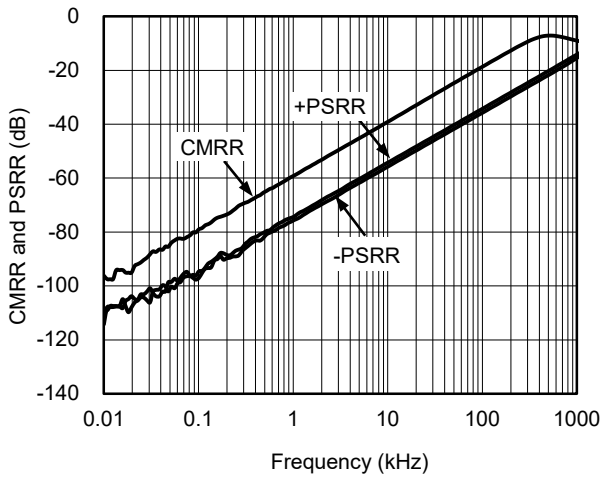

Open-Loop Gain and Phase vs. Frequency

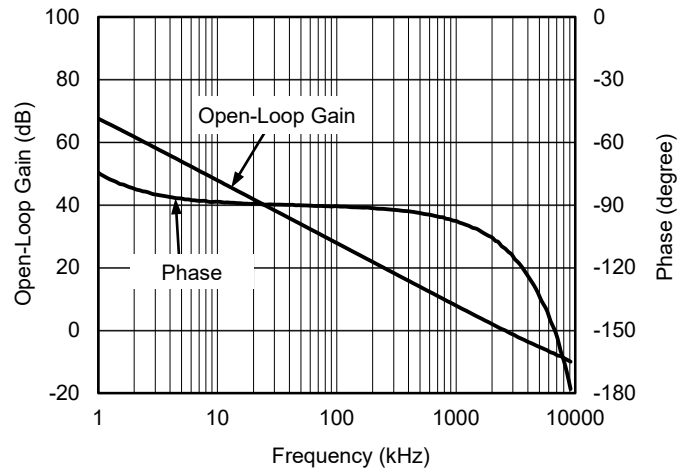

Maximum Output Voltage vs. Frequency

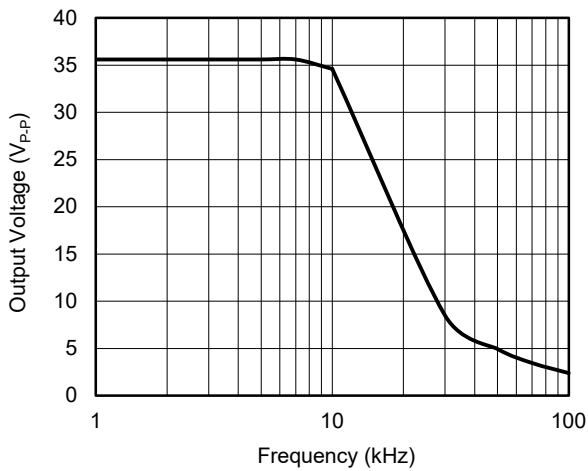

Input Voltage Noise Density vs. Frequency

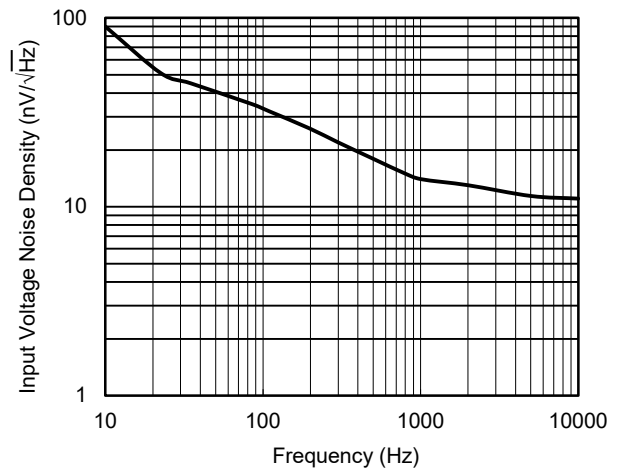

**TYPICAL PERFORMANCE CHARACTERISTICS (continued)**

At  $T_A = +25^\circ\text{C}$ ,  $V_S = 36\text{V}$  and  $R_L = 2\text{k}\Omega$ , unless otherwise noted.

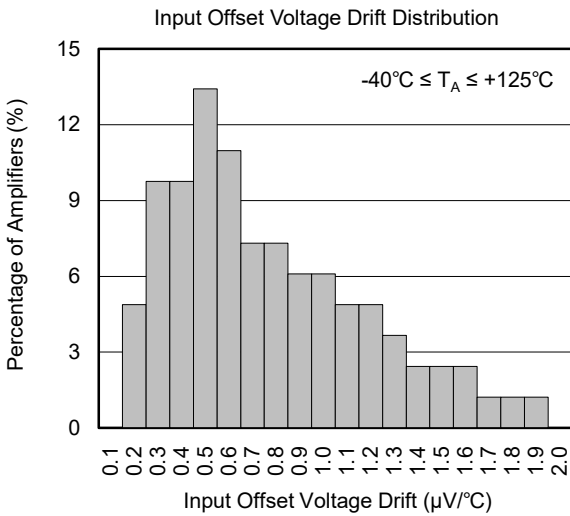
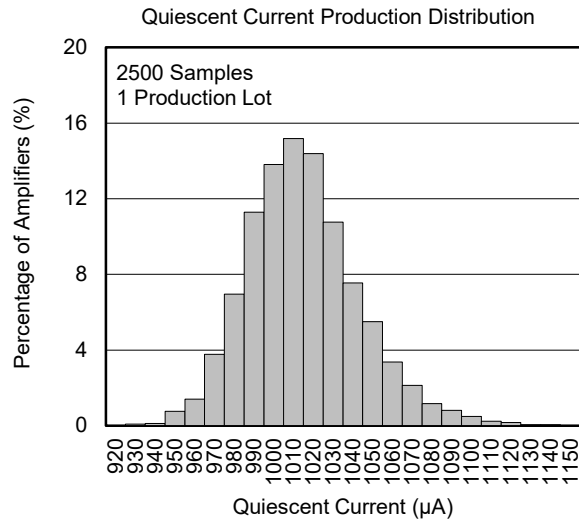
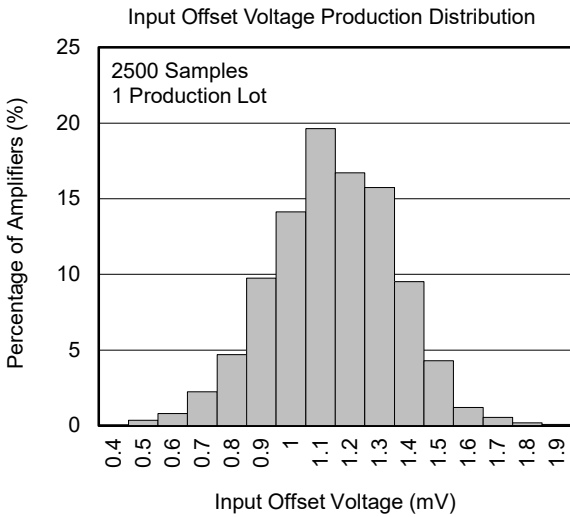
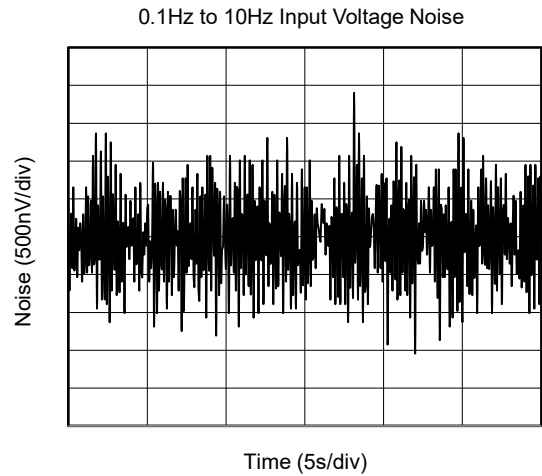
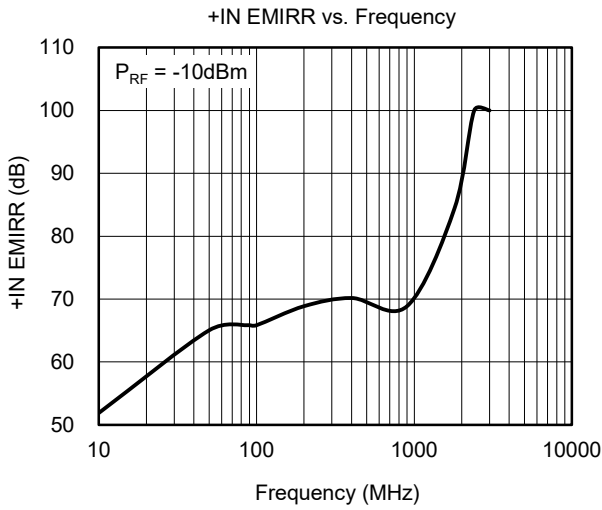

**REVISION HISTORY**

NOTE: Page numbers for previous revisions may differ from page numbers in the current version.

<b>JUNE 2018 – REV.A to REV.A.1</b>	<b>Page</b>
Added MSOP-8 Package.....	All

---

<b>Changes from Original (DECEMBER 2017) to REV.A</b>	<b>Page</b>
Changed from product preview to production data.....	All

---

# PACKAGE INFORMATION

## PACKAGE OUTLINE DIMENSIONS

### SOIC-8

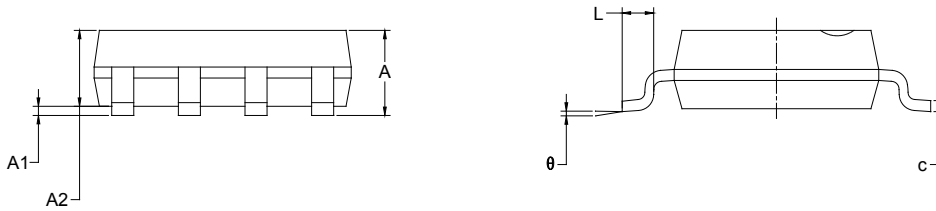
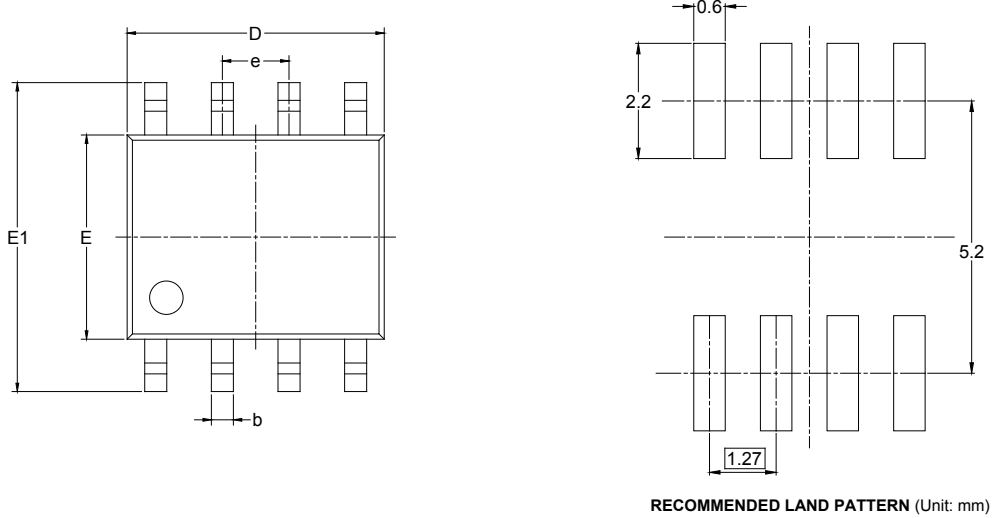

Symbol	Dimensions In Millimeters		Dimensions In Inches	
	MIN	MAX	MIN	MAX
A	1.350	1.750	0.053	0.069
A1	0.100	0.250	0.004	0.010
A2	1.350	1.550	0.053	0.061
b	0.330	0.510	0.013	0.020
c	0.170	0.250	0.006	0.010
D	4.700	5.100	0.185	0.200
E	3.800	4.000	0.150	0.157
E1	5.800	6.200	0.228	0.244
e	1.27 BSC		0.050 BSC	
L	0.400	1.270	0.016	0.050
$\theta$	0°	8°	0°	8°



PACKAGE OUTLINE DIMENSIONS

MSOP-8



RECOMMENDED LAND PATTERN (Unit: mm)

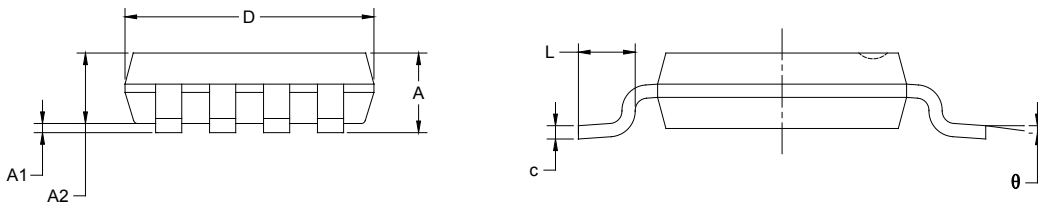

Symbol	Dimensions In Millimeters		Dimensions In Inches	
	MIN	MAX	MIN	MAX
A	0.820	1.100	0.032	0.043
A1	0.020	0.150	0.001	0.006
A2	0.750	0.950	0.030	0.037
b	0.250	0.380	0.010	0.015
c	0.090	0.230	0.004	0.009
D	2.900	3.100	0.114	0.122
E	2.900	3.100	0.114	0.122
E1	4.750	5.050	0.187	0.199
e	0.650 BSC		0.026 BSC	
L	0.400	0.800	0.016	0.031
θ	0°	6°	0°	6°

# PACKAGE INFORMATION

## TAPE AND REEL INFORMATION

### REEL DIMENSIONS



### TAPE DIMENSIONS



NOTE: The picture is only for reference. Please make the object as the standard.

### KEY PARAMETER LIST OF TAPE AND REEL

Package Type	Reel Diameter	Reel Width W1 (mm)	A0 (mm)	B0 (mm)	K0 (mm)	P0 (mm)	P1 (mm)	P2 (mm)	W (mm)	Pin1 Quadrant
SOIC-8	13"	12.4	6.40	5.40	2.10	4.0	8.0	2.0	12.0	Q1
MSOP-8	13"	12.4	5.20	3.30	1.50	4.0	8.0	2.0	12.0	Q1

DD0001

# PACKAGE INFORMATION

## CARTON BOX DIMENSIONS



NOTE: The picture is only for reference. Please make the object as the standard.

## KEY PARAMETER LIST OF CARTON BOX

Reel Type	Length (mm)	Width (mm)	Height (mm)	Pizza/Carton
13"	386	280	370	5

DD0002