

SGM2034

1 μ A Ultra-Low Current Consumption and Low Dropout CMOS Voltage Regulator

GENERAL DESCRIPTION

The SGM2034 is an ultra-low current consumption, low dropout voltage and high accuracy linear regulator. It is capable of supplying 250mA output current with only 1 μ A (TYP) current consumption. The typical dropout voltage is only 70mV at 100mA. The operating input voltage range is from 1.7V to 7.5V and fixed output voltages are 1.2V, 1.8V, 2.5V, 2.8V, 3.0V, 3.3V, 3.6V, 3.8V, 4.0V, 4.5V and 5.0V.

Other features include short-circuit current limit and thermal shutdown protection.

The SGM2034 is available in Green SOT-23-3 and SOT-89-3 packages. It operates over an operating temperature range of -40°C to +85°C.

FEATURES

- **Operating Input Voltage Range: 1.7V to 7.5V**
- **Fixed Outputs of 1.2V, 1.8V, 2.5V, 2.8V, 3.0V, 3.3V, 3.6V, 3.8V, 4.0V, 4.5V and 5.0V**
- **250mA Output Current**
- **High Output Voltage Accuracy: $\pm 1.2\%$ at +25°C**
- **Ultra-Low Quiescent Current: 1 μ A (TYP)**
- **Low Dropout Voltage: 70mV (TYP) at 100mA**
- **Low Reverse Leakage Current: 0.4 μ A (TYP) when $V_{OUT} > V_{IN}$**
- **Current Limiting and Thermal Protection**
- **-40°C to +85°C Operating Temperature Range**
- **Available in Green SOT-23-3 and SOT-89-3 Packages**

APPLICATIONS

Wearable Device
Smart Phone
Portable Equipment

TYPICAL APPLICATION

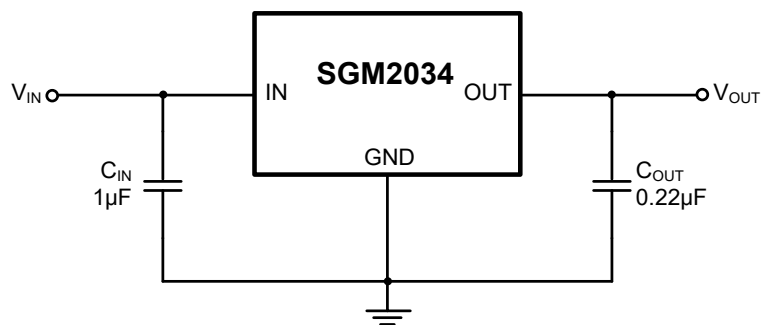

Figure 1. Typical Application Circuit

PACKAGE/ORDERING INFORMATION

MODEL	PACKAGE DESCRIPTION	SPECIFIED TEMPERATURE RANGE	ORDERING NUMBER	PACKAGE MARKING	PACKING OPTION
SGM2034-1.2	SOT-23-3	-40°C to +85°C	SGM2034-1.2YN3G/TR	M90XX	Tape and Reel, 3000
	SOT-89-3	-40°C to +85°C	SGM2034-1.2YK3G/TR	M8FXX	Tape and Reel, 1000
SGM2034-1.8	SOT-23-3	-40°C to +85°C	SGM2034-1.8YN3G/TR	GRCXX	Tape and Reel, 3000
	SOT-89-3	-40°C to +85°C	SGM2034-1.8YK3G/TR	GR2XX	Tape and Reel, 1000
SGM2034-2.5	SOT-23-3	-40°C to +85°C	SGM2034-2.5YN3G/TR	M56XX	Tape and Reel, 3000
	SOT-89-3	-40°C to +85°C	SGM2034-2.5YK3G/TR	M57XX	Tape and Reel, 1000
SGM2034-2.8	SOT-23-3	-40°C to +85°C	SGM2034-2.8YN3G/TR	GR4XX	Tape and Reel, 3000
	SOT-89-3	-40°C to +85°C	SGM2034-2.8YK3G/TR	GR3XX	Tape and Reel, 1000
SGM2034-3.0	SOT-23-3	-40°C to +85°C	SGM2034-3.0YN3G/TR	GP9XX	Tape and Reel, 3000
	SOT-89-3	-40°C to +85°C	SGM2034-3.0YK3G/TR	M2EXX	Tape and Reel, 1000
SGM2034-3.3	SOT-23-3	-40°C to +85°C	SGM2034-3.3YN3G/TR	GRDXX	Tape and Reel, 3000
	SOT-89-3	-40°C to +85°C	SGM2034-3.3YK3G/TR	GR5XX	Tape and Reel, 1000
SGM2034-3.6	SOT-23-3	-40°C to +85°C	SGM2034-3.6YN3G/TR	GR7XX	Tape and Reel, 3000
	SOT-89-3	-40°C to +85°C	SGM2034-3.6YK3G/TR	GR6XX	Tape and Reel, 1000
SGM2034-3.8	SOT-23-3	-40°C to +85°C	SGM2034-3.8YN3G/TR	CKEXX	Tape and Reel, 3000
SGM2034-4.0	SOT-23-3	-40°C to +85°C	SGM2034-4.0YN3G/TR	M97XX	Tape and Reel, 3000
	SOT-89-3	-40°C to +85°C	SGM2034-4.0YK3G/TR	M98XX	Tape and Reel, 1000
SGM2034-4.5	SOT-89-3	-40°C to +85°C	SGM2034-4.5YK3G/TR	GR8XX	Tape and Reel, 1000
SGM2034-5.0	SOT-23-3	-40°C to +85°C	SGM2034-5.0YN3G/TR	GREXX	Tape and Reel, 3000
	SOT-89-3	-40°C to +85°C	SGM2034-5.0YK3G/TR	GRAXX	Tape and Reel, 1000

MARKING INFORMATION

NOTE: XX = Date Code.

YYY X X

Date Code - Week

Date Code - Year

Serial Number

Green (RoHS & HSF): SG Micro Corp defines "Green" to mean Pb-Free (RoHS compatible) and free of halogen substances. If you have additional comments or questions, please contact your SGMICRO representative directly.

ABSOLUTE MAXIMUM RATINGS

IN to GND -0.3V to 8V
 OUT to GND -0.3V to 6V
 Package Thermal Resistance
 SOT-23-3, θ_{JA} 283°C/W
 SOT-89-3, θ_{JA} 101°C/W
 Junction Temperature +150°C
 Storage Temperature Range -65°C to +150°C
 Lead Temperature (Soldering, 10s) +260°C
 ESD Susceptibility
 HBM 8000V
 MM 400V
 CDM 1000V

RECOMMENDED OPERATING CONDITIONS

Input Voltage Range 1.7V to 7.5V
 Input Effective Capacitance, C_{IN} 0.5µF (MIN)
 Output Effective Capacitance, C_{OUT} 0.1µF to 10µF
 Operating Junction Temperature Range -40°C to +85°C

OVERSTRESS CAUTION

Stresses beyond those listed in Absolute Maximum Ratings may cause permanent damage to the device. Exposure to absolute maximum rating conditions for extended periods may affect reliability. Functional operation of the device at any conditions beyond those indicated in the Recommended Operating Conditions section is not implied.

ESD SENSITIVITY CAUTION

This integrated circuit can be damaged if ESD protections are not considered carefully. SGMICRO recommends that all integrated circuits be handled with appropriate precautions. Failure to observe proper handling and installation procedures can cause damage. ESD damage can range from subtle performance degradation to complete device failure. Precision integrated circuits may be more susceptible to damage because even small parametric changes could cause the device not to meet the published specifications.

DISCLAIMER

SG Micro Corp reserves the right to make any change in circuit design, or specifications without prior notice.

PIN CONFIGURATIONS

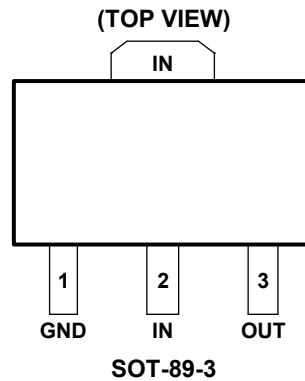
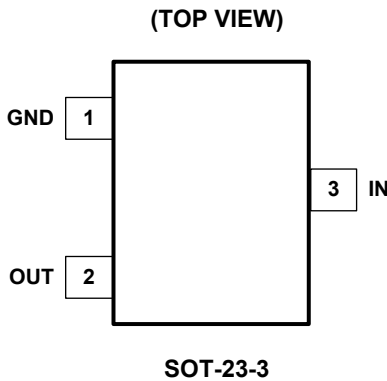

PIN DESCRIPTION

PIN		NAME	FUNCTION
SOT-23-3	SOT-89-3		
1	1	GND	Ground Pin.
2	3	OUT	Regulator Output Pin. It is recommended to use a ceramic capacitor with effective capacitance in the range of 0.1µF to 10µF to get good power supply decoupling. This ceramic capacitor should be placed as close as possible to OUT pin.
3	2	IN	Input Supply Voltage Pin. It is recommended to use a 1µF or larger ceramic capacitor from IN pin to ground. This ceramic capacitor should be placed as close as possible to IN pin.

ELECTRICAL CHARACTERISTICS

($V_{IN} = V_{OUT(NOM)} + 1V$, $I_{OUT} = 0.1mA$, $C_{IN} = 1\mu F$ and $C_{OUT} = 0.22\mu F$, Full = $-40^{\circ}C$ to $+85^{\circ}C$, typical values are at $T_J = +25^{\circ}C$, unless otherwise noted.)

PARAMETER	SYMBOL	CONDITIONS	TEMP	MIN	TYP	MAX	UNITS	
Input Voltage Range	V_{IN}		Full	1.7		7.5	V	
Output Voltage Accuracy	V_{OUT}	$V_{IN} = (V_{OUT(NOM)} + 1V)$ to 7.5V	$+25^{\circ}C$	-1.2		1.2	%	
Maximum Output Current			$+25^{\circ}C$	250			mA	
Output Current Limit	I_{LIMIT}		$+25^{\circ}C$	280	480		mA	
Supply Pin Current	I_Q	No load	Full		1.0	1.5	μA	
Dropout Voltage ⁽¹⁾	V_{DROP}	$I_{OUT} = 100mA$	$1.8V \leq V_{OUT(NOM)} < 2.5V$	$+25^{\circ}C$		145	200	mV
			$2.5V \leq V_{OUT(NOM)} < 3.3V$	$+25^{\circ}C$		100	130	
			$3.3V \leq V_{OUT(NOM)} < 4.2V$	$+25^{\circ}C$		85	110	
			$4.2V \leq V_{OUT(NOM)} < 5.2V$	$+25^{\circ}C$		75	100	
Line Regulation	$\frac{\Delta V_{OUT}}{\Delta V_{IN} \times V_{OUT}}$	$V_{IN} = (V_{OUT(NOM)} + 1V)$ to 7.5V	$+25^{\circ}C$		0.002	0.1	%/V	
Load Regulation	ΔV_{OUT}	$I_{OUT} = 0.1mA$ to 250mA	$+25^{\circ}C$		3	15	mV	
Short Current Limit	I_{SHORT}	$V_{OUT} = 0V$	$+25^{\circ}C$		100		mA	
Reverse Leakage Current ⁽²⁾	I_{RL}	$V_{IN} = 1.7V$, $V_{OUT} = 5.5V$	$+25^{\circ}C$		0.4		μA	
Power Supply Rejection Ratio	PSRR	$I_{OUT} = 30mA$, $V_{OUT} = 1.8V$, $\Delta V_{RIPPLE} = 0.2V_{P-P}$	$f = 217Hz$	$+25^{\circ}C$		38	dB	
			$f = 1kHz$	$+25^{\circ}C$		27		
Output Voltage Temperature Coefficient ⁽³⁾	$\frac{\Delta V_{OUT}}{\Delta T_J \times V_{OUT}}$		Full		18		ppm/ $^{\circ}C$	
Thermal Shutdown Temperature	T_{SHDN}				165		$^{\circ}C$	
Thermal Shutdown Hysteresis	ΔT_{SHDN}				30		$^{\circ}C$	

NOTES:

1. The dropout voltage is defined as the difference between V_{IN} and V_{OUT} when V_{OUT} falls to $95\% \times V_{OUT(NOM)}$.
2. Reverse leakage current is the current flows from the output to the input when $V_{OUT} > V_{IN}$.
3. Output voltage temperature coefficient is defined as the worst-case voltage change divided by the total temperature range.

TYPICAL PERFORMANCE CHARACTERISTICS

$T_J = +25^\circ\text{C}$, $V_{IN} = V_{OUT(NOM)} + 1\text{V}$, $C_{IN} = 1\mu\text{F}$ and $C_{OUT} = 0.22\mu\text{F}$, unless otherwise noted.

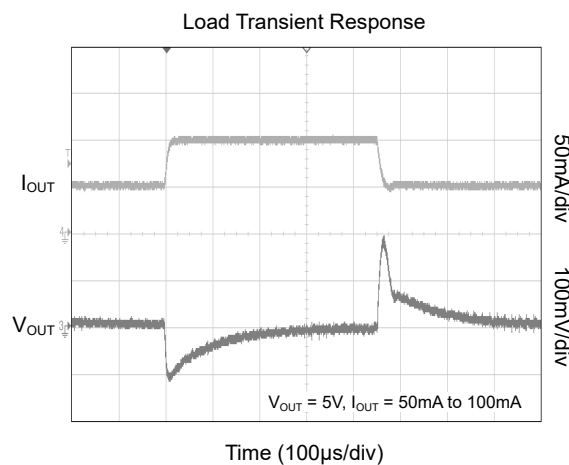
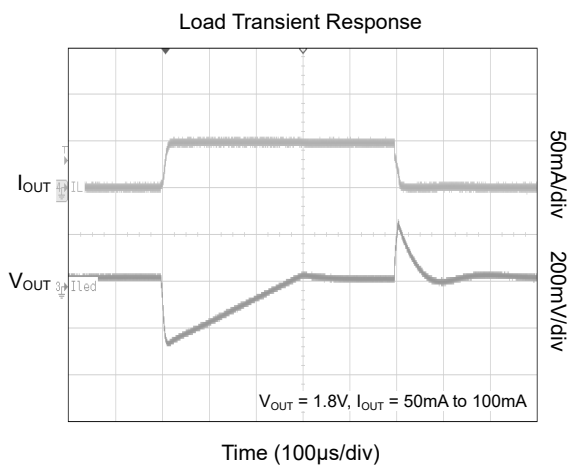
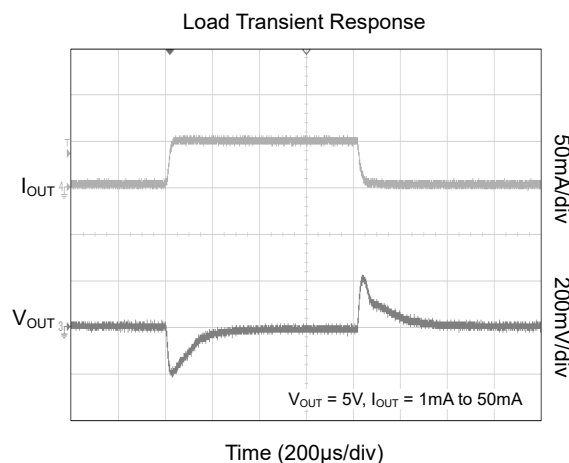
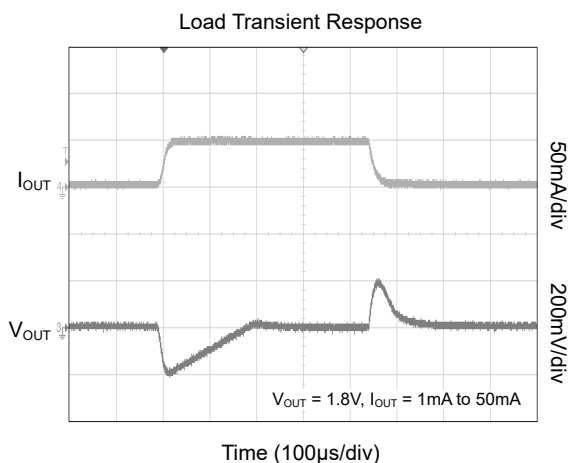
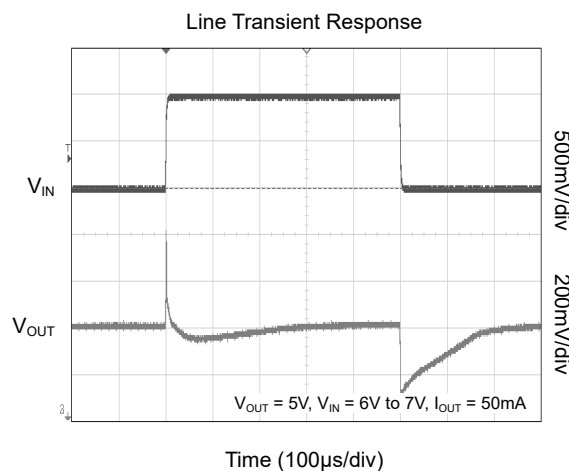
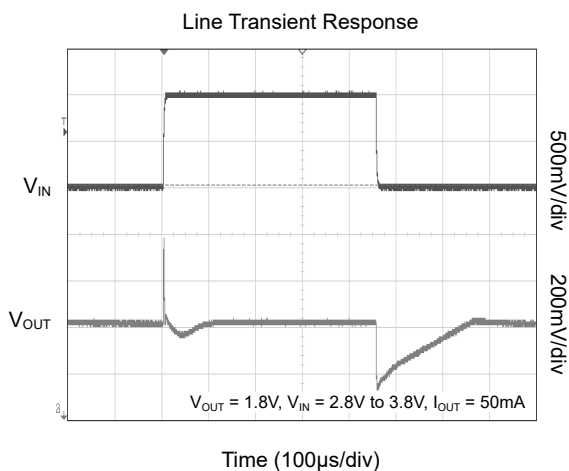

TYPICAL PERFORMANCE CHARACTERISTICS (continued)

$T_J = +25^\circ\text{C}$, $V_{IN} = V_{OUT(NOM)} + 1\text{V}$, $C_{IN} = 1\mu\text{F}$ and $C_{OUT} = 0.22\mu\text{F}$, unless otherwise noted.

Power-Up Output Waveform

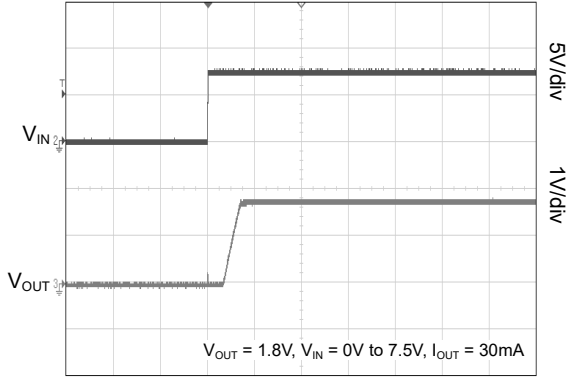

Time (5ms/div)

Power-Up Output Waveform

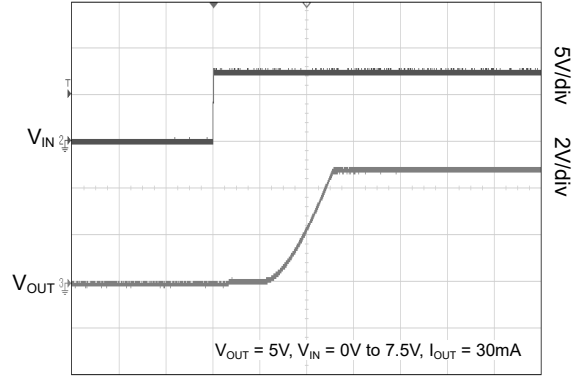

Time (5ms/div)

Power Supply Rejection Ratio vs. Frequency

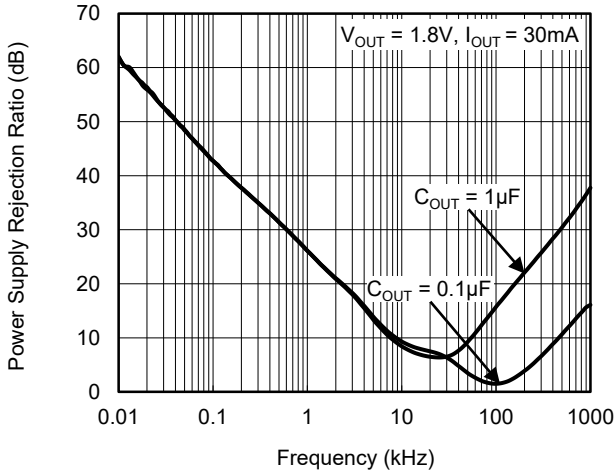

Power Supply Rejection Ratio vs. Frequency

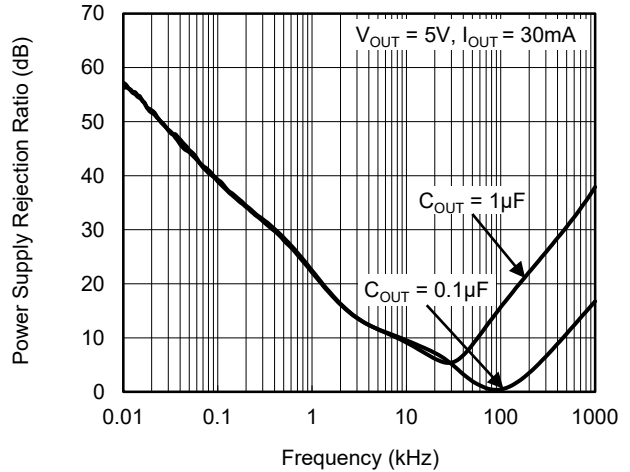

Dropout Voltage vs. Output Current

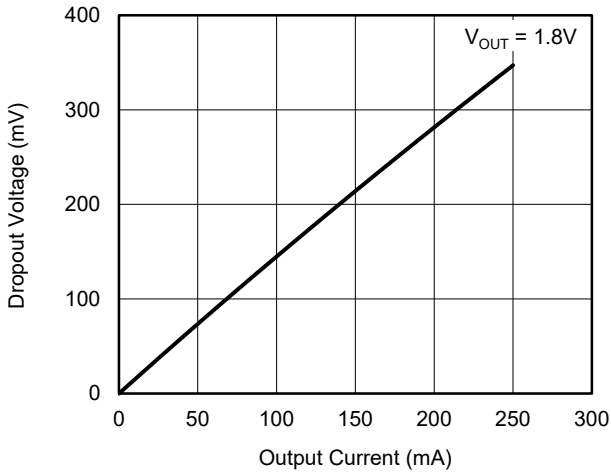

Dropout Voltage vs. Output Current

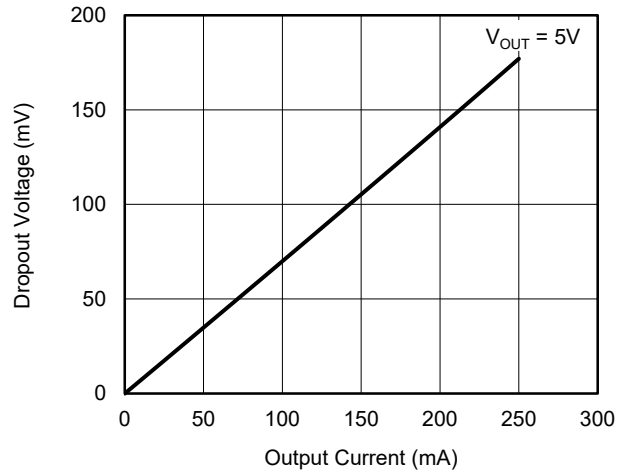

TYPICAL PERFORMANCE CHARACTERISTICS (continued)

$T_J = +25^\circ\text{C}$, $V_{IN} = V_{OUT(NOM)} + 1\text{V}$, $C_{IN} = 1\mu\text{F}$ and $C_{OUT} = 0.22\mu\text{F}$, unless otherwise noted.

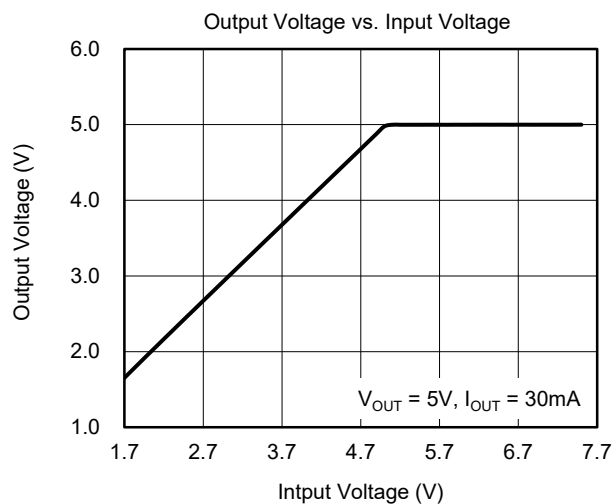
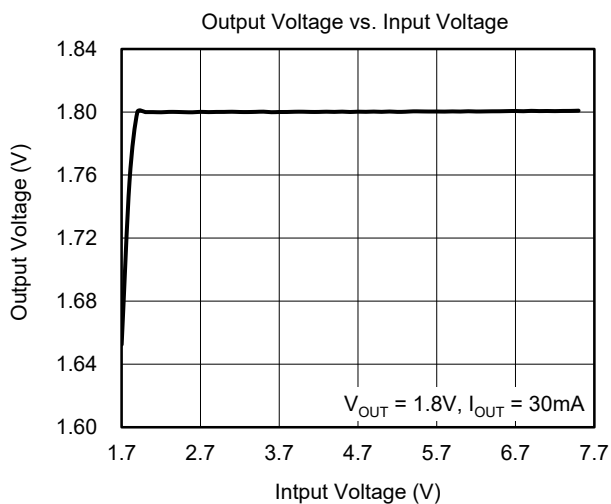
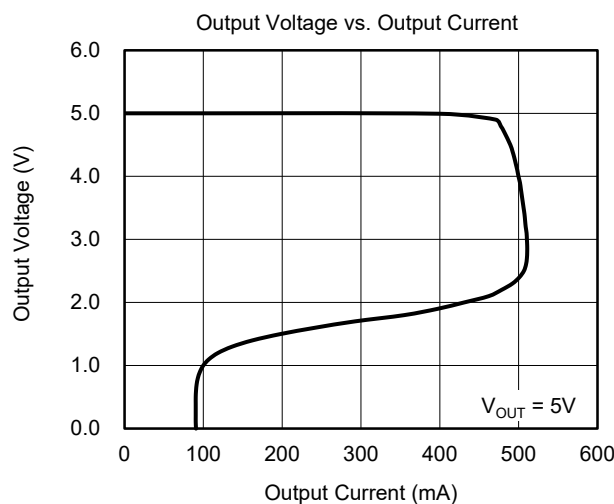
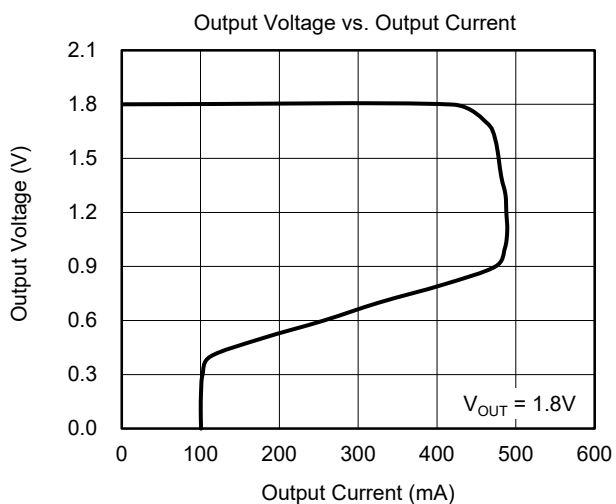
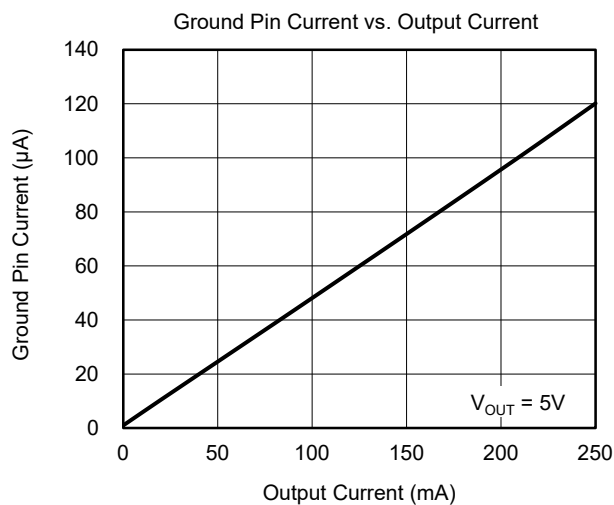
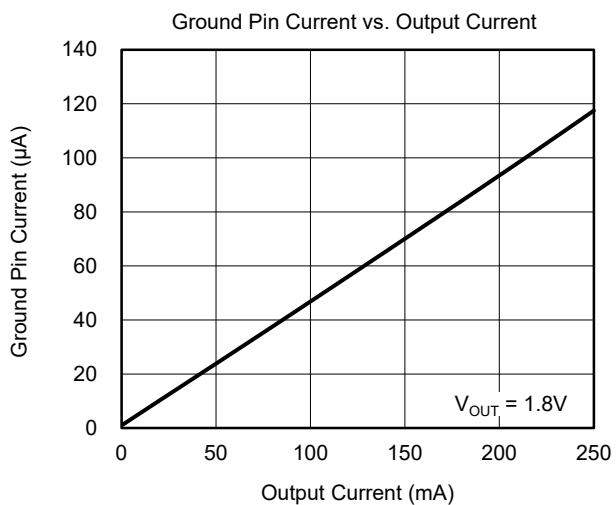

TYPICAL PERFORMANCE CHARACTERISTICS (continued)

$T_J = +25^\circ\text{C}$, $V_{IN} = V_{OUT(NOM)} + 1\text{V}$, $C_{IN} = 1\mu\text{F}$ and $C_{OUT} = 0.22\mu\text{F}$, unless otherwise noted.

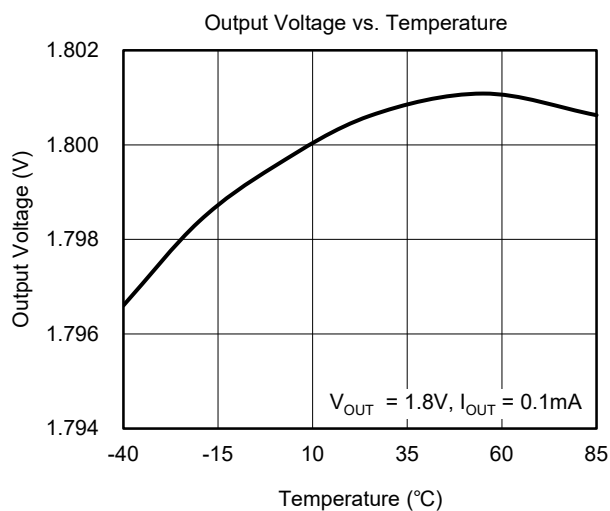
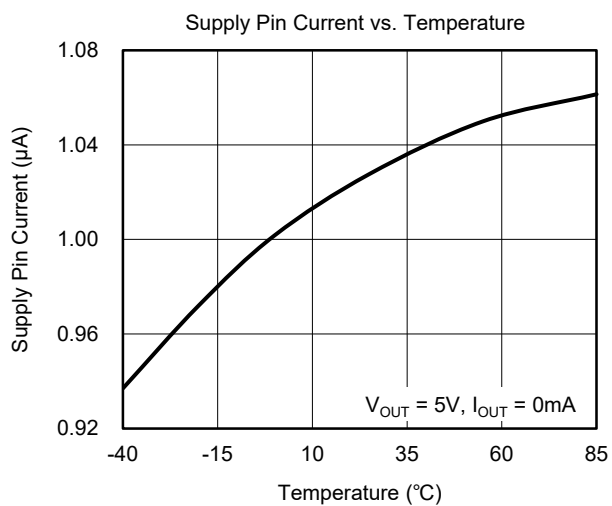
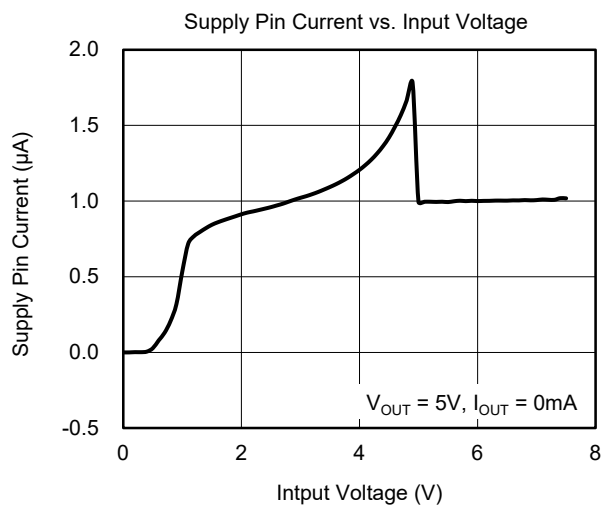
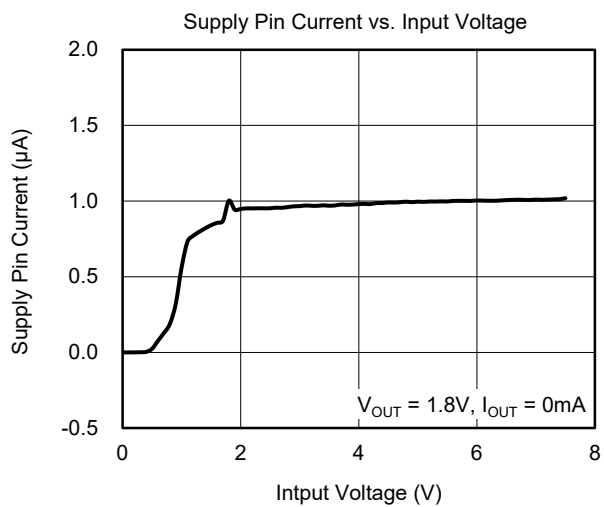

FUNCTIONAL BLOCK DIAGRAM

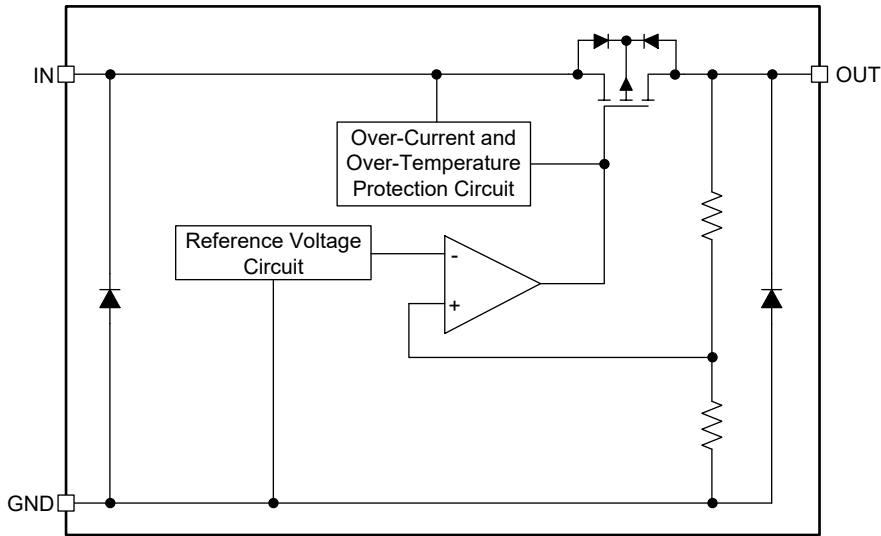

Figure 2. Block Diagram

APPLICATION INFORMATION

Input Capacitor Selection (C_{IN})

The input decoupling capacitor is necessary to be connected as close as possible to the IN pin for ensuring the device stability. 1µF or larger X7R or X5R ceramic capacitor is selected to get good dynamic performance.

When V_{IN} is required to provide large current instantaneously, a large effective input capacitor is required. Multiple input capacitors can limit the input tracking inductance. Adding more input capacitors is available to restrict the ringing and to keep it below the device absolute maximum ratings.

Output Capacitor Selection (C_{OUT})

The output decoupling capacitor should be located as close as possible to the OUT pin. 0.22µF or larger X7R or X5R ceramic capacitor is selected to get good dynamic performance. The minimum effective capacitance of C_{OUT} that SGM2034 can remain stable is 0.1µF. For ceramic capacitor, temperature, DC bias and package size will change the effective capacitance, so enough margin of C_{OUT} must be considered in design. Larger capacitance and lower ESR C_{OUT} will

help improve the load transient response and increase the high frequency PSRR.

Output Current Limit and Short-Circuit Protection

When overload events happen, the output current is internally limited to 480mA (TYP). When the OUT pin is shorted to ground, the short-circuit protection will limit the output current to 100mA (TYP).

Reverse Current Protection

The SGM2034 incorporates reverse current protection circuit that prevents current flow backwards through the pass element when the output voltage is greater than the input voltage. A comparator senses the difference between the input and output voltages. When the difference between the output voltage and input voltage exceeds 800mV (TYP), the gate of the PFET is switched to V_{OUT} and the PFET is turned off. Otherwise, the gate voltage of the PFET is unfixed, and the reverse current may be (V_{OUT} - V_{IN}) / R_{ON}, R_{ON} = V_{DROP} / I_{OUT}.

REVISION HISTORY

NOTE: Page numbers for previous revisions may differ from page numbers in the current version.

NOVEMBER 2020 – REV.A.2 to REV.A.3	Page
Updated Application Information section.....	9
<hr/>	
SEPTEMBER 2019 – REV.A.1 to REV.A.2	Page
Added SGM2034-4.0YN3G/TR and SGM2034-4.0YK3G/TR versions.....	All
<hr/>	
JULY 2019 – REV.A to REV.A.1	Page
Added SGM2034-3.8YN3G/TR and SGM2034-4.5YK3G/TR versions.....	All
<hr/>	
Changes from Original (DECEMBER 2018) to REV.A	Page
Changed from product preview to production data	All

PACKAGE INFORMATION

PACKAGE OUTLINE DIMENSIONS

SOT-23-3

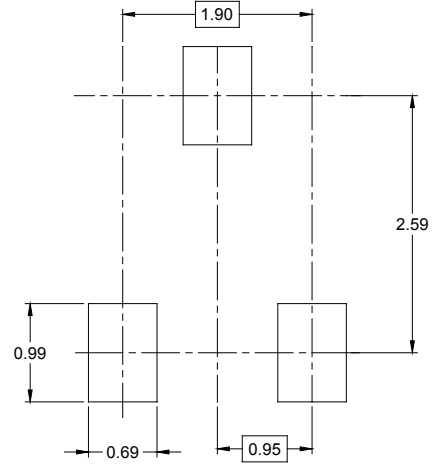
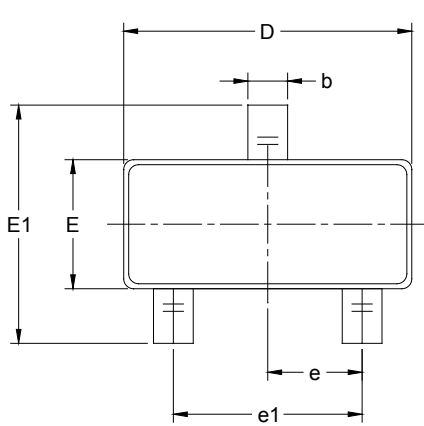

RECOMMENDED LAND PATTERN (Unit: mm)

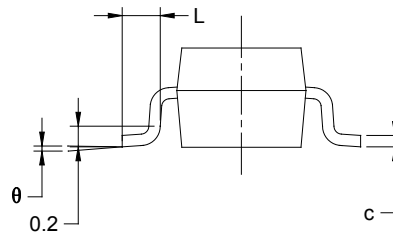
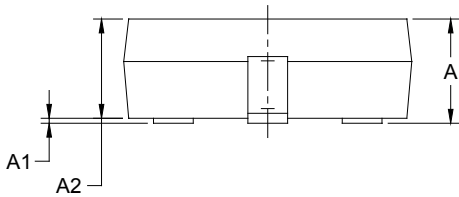

Symbol	Dimensions In Millimeters		Dimensions In Inches	
	MIN	MAX	MIN	MAX
A	1.050	1.250	0.041	0.049
A1	0.000	0.100	0.000	0.004
A2	1.050	1.150	0.041	0.045
b	0.300	0.500	0.012	0.020
c	0.100	0.200	0.004	0.008
D	2.820	3.020	0.111	0.119
E	1.500	1.700	0.059	0.067
E1	2.650	2.950	0.104	0.116
e	0.950 BSC		0.037 BSC	
e1	1.900 BSC		0.075 BSC	
L	0.300	0.600	0.012	0.024
θ	0°	8°	0°	8°

PACKAGE INFORMATION

PACKAGE OUTLINE DIMENSIONS

SOT-89-3

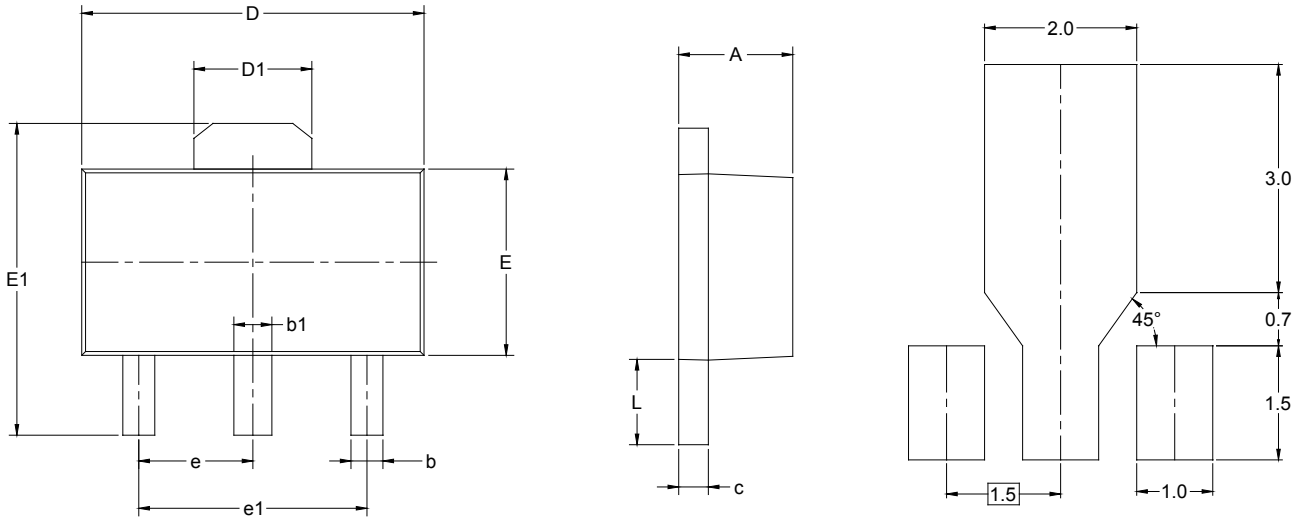

RECOMMENDED LAND PATTERN (Unit: mm)

Symbol	Dimensions In Millimeters		Dimensions In Inches	
	MIN	MAX	MIN	MAX
A	1.400	1.600	0.055	0.063
b	0.320	0.520	0.013	0.020
b1	0.400	0.580	0.016	0.023
c	0.350	0.440	0.014	0.017
D	4.400	4.600	0.173	0.181
D1	1.550 REF		0.061 REF	
E	2.300	2.600	0.091	0.102
E1	3.940	4.250	0.155	0.167
e	1.500 TYP		0.060 TYP	
e1	3.000 TYP		0.118 TYP	
L	0.900	1.200	0.035	0.047

PACKAGE INFORMATION

TAPE AND REEL INFORMATION

REEL DIMENSIONS

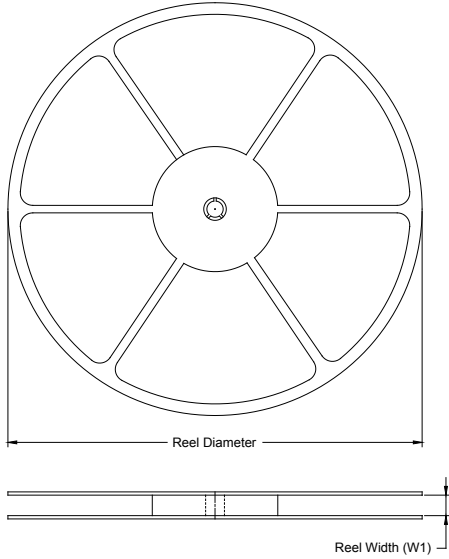

TAPE DIMENSIONS

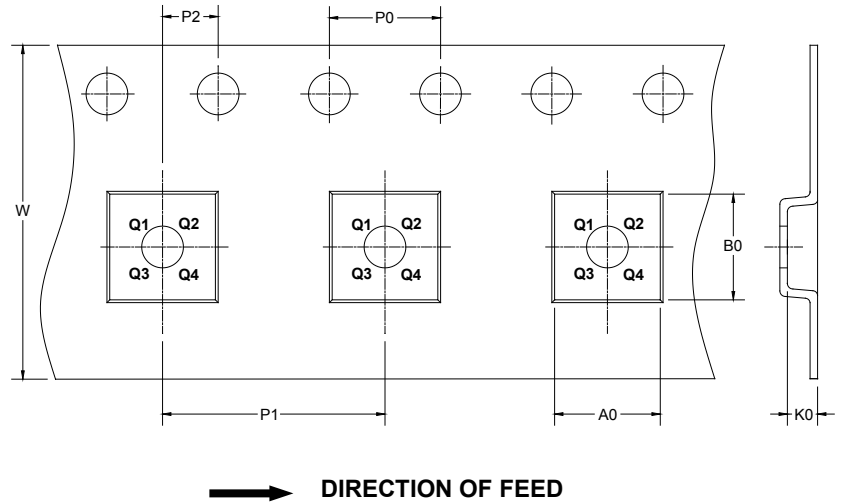

NOTE: The picture is only for reference. Please make the object as the standard.

KEY PARAMETER LIST OF TAPE AND REEL

Package Type	Reel Diameter	Reel Width W1 (mm)	A0 (mm)	B0 (mm)	K0 (mm)	P0 (mm)	P1 (mm)	P2 (mm)	W (mm)	Pin1 Quadrant
SOT-23-3	7"	9.0	3.20	3.30	1.30	4.0	4.0	2.0	8.0	Q3
SOT-89-3	7"	13.2	4.85	4.45	1.85	4.0	8.0	2.0	12.0	Q3

DD0001

PACKAGE INFORMATION

CARTON BOX DIMENSIONS

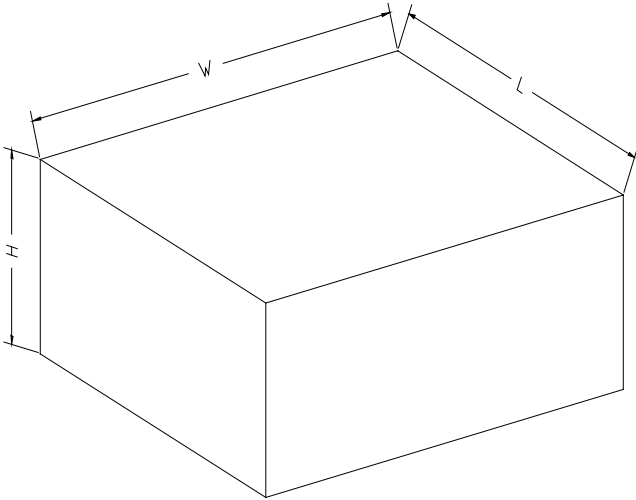

NOTE: The picture is only for reference. Please make the object as the standard.

KEY PARAMETER LIST OF CARTON BOX

Reel Type	Length (mm)	Width (mm)	Height (mm)	Pizza/Carton
7" (Option)	368	227	224	8
7"	442	410	224	18

DD0002