

# SGM61413

## 570kHz, 600mA, 42V

### Synchronous Buck Converter

## GENERAL DESCRIPTION

The SGM61413 is a high frequency, synchronous Buck converter with integrated switches. It can deliver up to 600mA to the output over a wide input voltage range of 5V to 42V. It is suitable for various industrial or automotive applications with high input voltage or for power conditioning from unregulated sources. Moreover, the low 14 $\mu$ A quiescent current and ultra-low shutdown current of only 0.6 $\mu$ A make it a suitable choice for battery-powered applications.

SGM61413 features high efficiency over a wide load range achieved by scaling down the switching frequency at light loads to reduce switching and gate driving losses. Other features include internal compensation, internal monotonic soft-start even with pre-biased output and fast loop response thanks to the peak-current mode controller. Switching at 570kHz, the SGM61413 can prevent EMI noise problems, such as the ones found in AM radio, ADSL and PLC applications.

Protection features include current limiting and short-circuit protection, thermal shutdown with auto recovery and output over-voltage protection. Frequency fold-back helps prevent inductor current runaway during startup.

SGM61413 is available in a Green SOT-23-6 package. It operates over a wide ambient temperature range of -40°C to +125°C.

## FEATURES

- Wide 5V to 42V Operating Input Voltage Range
- 0.8V Internal Reference
- Shutdown Current: 0.6 $\mu$ A (TYP)
- Current Output up to 600mA
- 570kHz Switching Frequency
- Internal Compensation and Soft-Start
- Simple Design and Minimal External Components
- Up to 95% Efficiency at 12V/400mA
- 0.8V to 20V Adjustable Output Voltage
- Current Limit and Short-Circuit Protection
- Output Over-Voltage Protection and Thermal Shutdown
- Power-Save Mode Operation
- Monotonic Startup with Pre-biased Output
- 94% Maximum Duty Cycle
- Available in a Green SOT-23-6 Package
- -40°C to +125°C Operating Temperature Range

## APPLICATIONS

High Voltage Power Conversions  
Automotive Systems  
Industrial Power Systems  
Distributed Power Systems  
Battery Powered Systems  
Power Meters

## TYPICAL APPLICATION

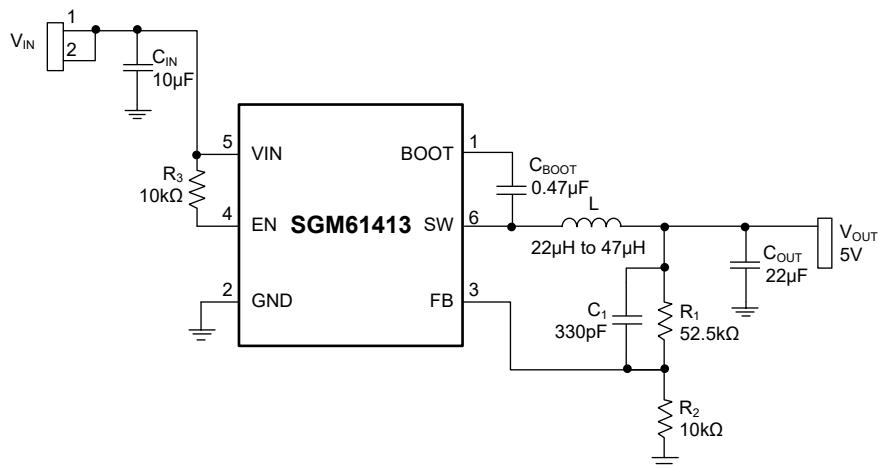

Figure 1. Typical Application Circuit

**PACKAGE/ORDERING INFORMATION**

MODEL	PACKAGE DESCRIPTION	SPECIFIED TEMPERATURE RANGE	ORDERING NUMBER	PACKAGE MARKING	PACKING OPTION
SGM61413	SOT-23-6	-40°C to +125°C	SGM61413XN6G/TR	R10XX	Tape and Reel, 3000

**MARKING INFORMATION**

NOTE: XX = Date Code.

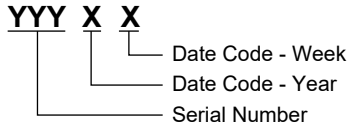

Green (RoHS & HSF): SG Micro Corp defines "Green" to mean Pb-Free (RoHS compatible) and free of halogen substances. If you have additional comments or questions, please contact your SGMICRO representative directly.

**ABSOLUTE MAXIMUM RATINGS**

VIN to GND	-0.3V to 45V
EN to GND	-0.3V to VIN + 0.3V
FB to GND	-0.3V to 5.5V
SW to GND	-0.3V to VIN + 0.3V
BOOT to SW	-0.3V to 5.5V
Package Thermal Resistance	
SOT-23-6, θJA	170°C/W
Junction Temperature	+150°C
Storage Temperature Range	-65°C to +150°C
Lead Temperature (Soldering, 10s)	+260°C
ESD Susceptibility	
HBM	2500V
CDM	1000V

**RECOMMENDED OPERATING CONDITIONS**

Supply Input Voltage Range	5V to 42V
Operating Junction Temperature Range	-40°C to +125°C

**OVERSTRESS CAUTION**

Stresses beyond those listed in Absolute Maximum Ratings may cause permanent damage to the device. Exposure to absolute maximum rating conditions for extended periods may affect reliability. Functional operation of the device at any conditions beyond those indicated in the Recommended Operating Conditions section is not implied.

**ESD SENSITIVITY CAUTION**

This integrated circuit can be damaged if ESD protections are not considered carefully. SGMICRO recommends that all integrated circuits be handled with appropriate precautions. Failure to observe proper handling and installation procedures can cause damage. ESD damage can range from subtle performance degradation to complete device failure. Precision integrated circuits may be more susceptible to damage because even small parametric changes could cause the device not to meet the published specifications.

**DISCLAIMER**

SG Micro Corp reserves the right to make any change in circuit design, or specifications without prior notice.

## PIN CONFIGURATION

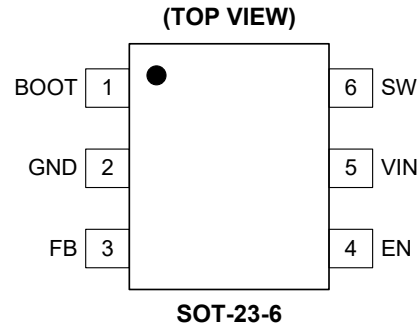

## PIN DESCRIPTION

PIN	NAME	FUNCTION
1	BOOT	Bootstrap pin is used to provide a drive voltage, higher than the input voltage, to the high-side power switch. Place a 0.47 $\mu$ F Boost capacitor ( $C_{BOOT}$ ) as close as possible to the IC between this pin and SW pin.
2	GND	Ground pin is the reference for input and the regulated output voltages. Special layout considerations are required.
3	FB	Feedback pin for programming the output voltage. The SGM61413 regulates the FB pin to 0.8V. Connect the feedback resistor divider tap to this pin. If the FB voltage exceeds 111% of 0.8V, over-voltage protection (OVP) will stop all PWM switching.
4	EN	Enable pin should not be left open and it should not be driven above $V_{IN} + 0.3V$ . Device will operate when the EN pin is high and shut down when the EN pin is low. EN can be tied to VIN pin via a resistor if the shutdown feature is not required or to a logic input for controlling shutdown.
5	VIN	VIN pin is connected to the input supply voltage and powers the internal control circuitry. This voltage is monitored by a UVLO lockout comparator. VIN is also connected to the drain of the converter high-side switch. Due to power switching, this pin has high di/dt transition edges and must be decoupled to the GND by input capacitors as close as possible to the GND pin to minimize the parasitic inductances.
6	SW	Switching node pin is the output of the internal power converter and should be connected to the output inductor. Bootstrap capacitor also connects to this pin. This node should be kept small on the PCB to minimize capacitive coupling, noise coupling and radiation.

**ELECTRICAL CHARACTERISTICS**(V<sub>IN</sub> = 18V, V<sub>EN</sub> = V<sub>IN</sub>, T<sub>J</sub> = -40°C to +125°C, typical values are at T<sub>J</sub> = +25°C, unless otherwise noted.)

PARAMETER	SYMBOL	CONDITIONS	MIN	TYP	MAX	UNITS
Supply Input Voltage	V <sub>IN</sub>		5		42	V
Under-Voltage Lockout Threshold	V <sub>UVLO</sub>		4.4	4.7	5.0	V
Under-Voltage Lockout Threshold Hysteresis	V <sub>UVLO_HYS</sub>			380		mV
VIN Quiescent Current	Shutdown	I <sub>Q</sub>	V <sub>EN</sub> = 0V	0.6	1.4	μA
	Sleep Mode		V <sub>EN</sub> = 2V, Not Switching, V <sub>IN</sub> ≤ 36V	14	20	
Feedback Reference Voltage	V <sub>FB</sub>	V <sub>IN</sub> = 5V	0.770	0.800	0.830	V
Feedback Pin Input Current	I <sub>FB</sub>	V <sub>FB</sub> = 1V		0.1	1	μA
Minimum High-side Switch On-Time	t <sub>ON_MIN</sub>	I <sub>LOAD</sub> = 600mA		100		ns
Minimum High-side Switch Off-Time	t <sub>OFF_MIN</sub>			100		ns
Switching Frequency	f <sub>SW</sub>		400	570	740	kHz
Switch Leakage Current	I <sub>SW_H</sub>	V <sub>SW</sub> = 42V		0.1	1	μA
	I <sub>SW_L</sub>	V <sub>SW</sub> = 0V		0.1	1	μA
High-side Power NMOS Current Limit	I <sub>LIM</sub>	T <sub>J</sub> = +25°C	1.0	1.3	1.7	A
High-side Power NMOS On-Resistance	R <sub>DSON</sub>	I <sub>LOAD</sub> = 0.1A		700		mΩ
Low-side Power NMOS On-Resistance		I <sub>LOAD</sub> = 0.1A		300		mΩ
EN Input High Voltage	V <sub>IH</sub>		1.3			V
EN Input Low Voltage	V <sub>IL</sub>				0.6	
EN Threshold, Hysteresis	V <sub>EN_HYS</sub>			120		mV
Enable Leakage Current	I <sub>EN</sub>	V <sub>EN</sub> = 5V		0.1	1	μA
Output Over-Voltage Threshold	V <sub>OUT_OV</sub>	OVP Rising	0.84	0.89	0.94	V
		OVP Falling	0.79	0.85	0.90	
Thermal Shutdown	T <sub>SHDN</sub>			145		°C
Thermal Shutdown Hysteresis	T <sub>HYS</sub>			20		°C

TYPICAL PERFORMANCE CHARACTERISTICS

T<sub>A</sub> = +25°C, V<sub>IN</sub> = 18V, L = 22µH and C<sub>OUT</sub> = 22µF, unless otherwise noted.

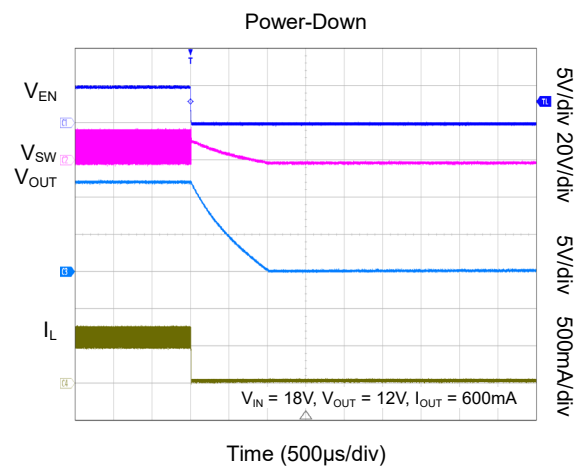
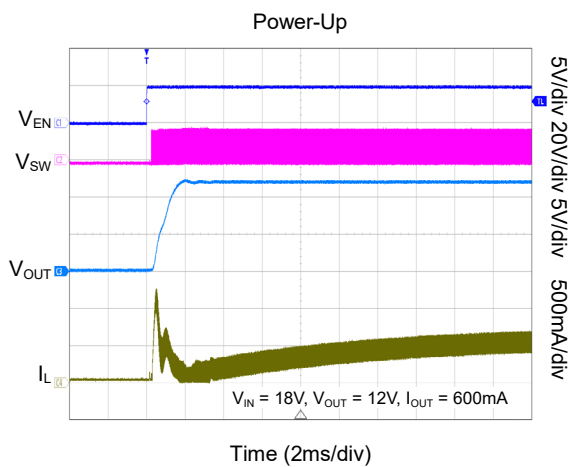
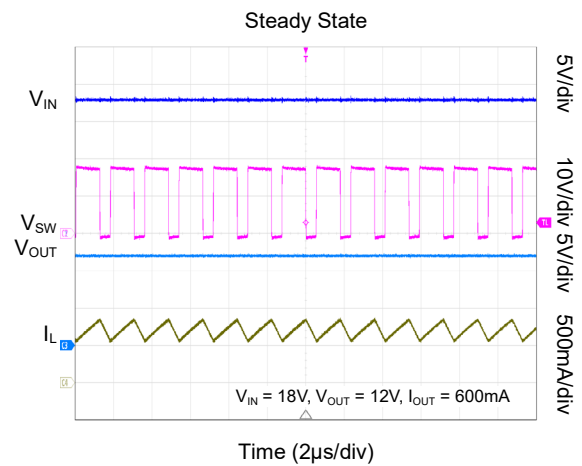
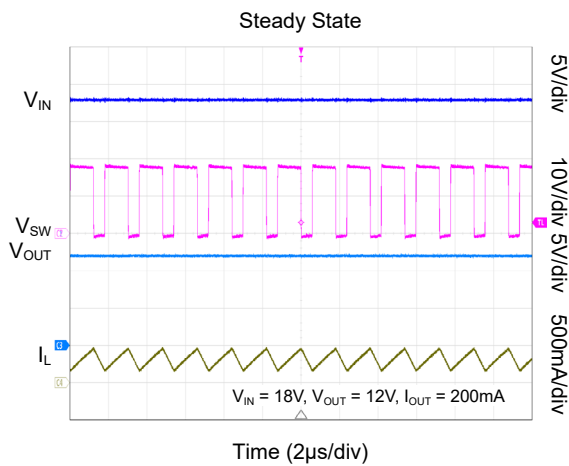
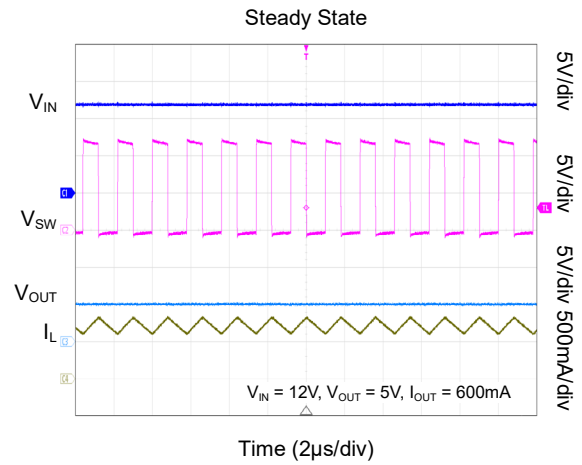
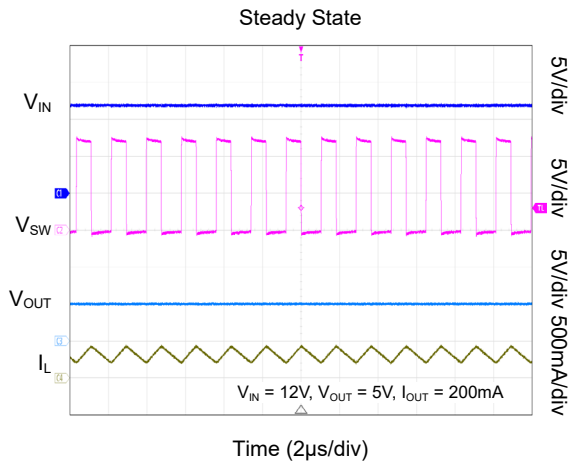

TYPICAL PERFORMANCE CHARACTERISTICS (continued)

$T_A = +25^\circ\text{C}$ ,  $V_{IN} = 18\text{V}$ ,  $L = 22\mu\text{H}$  and  $C_{OUT} = 22\mu\text{F}$ , unless otherwise noted.

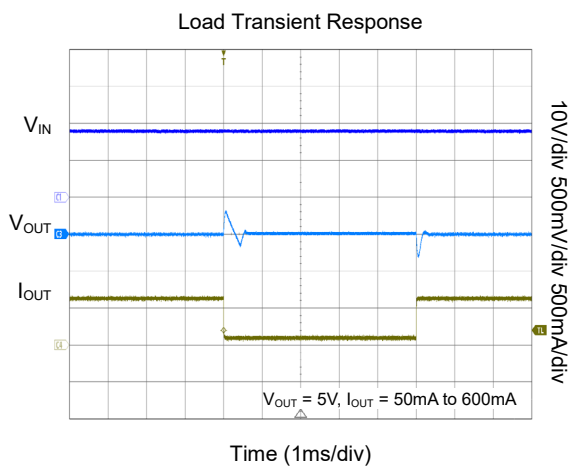
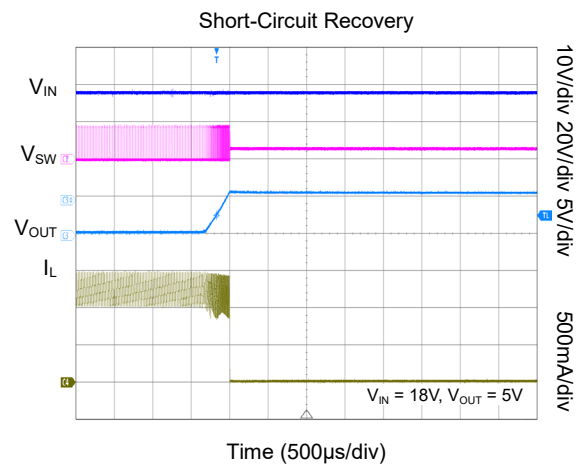
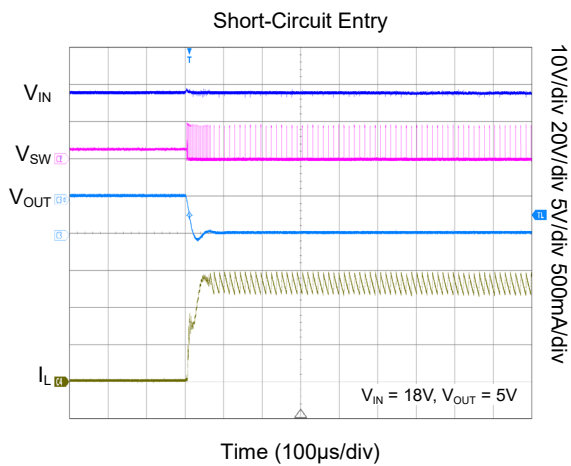
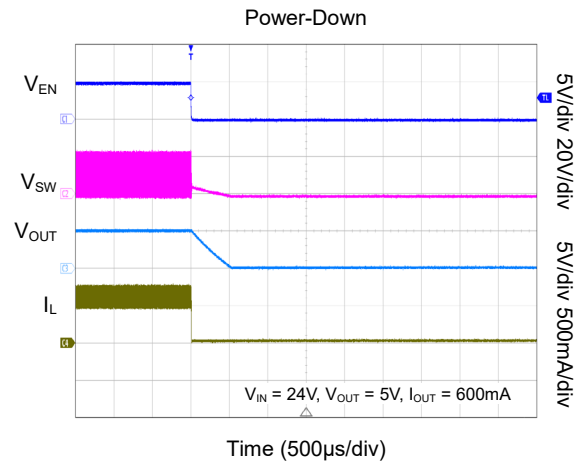
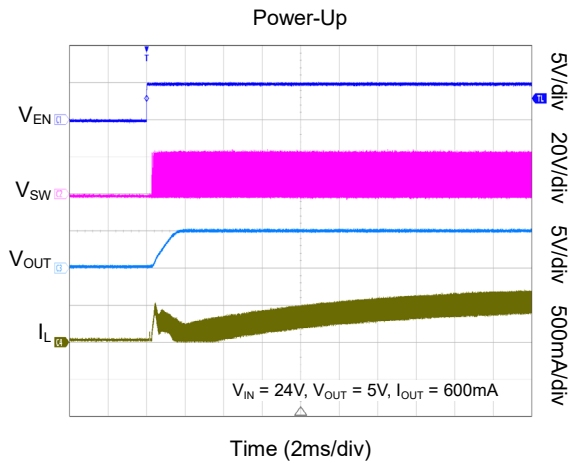

TYPICAL PERFORMANCE CHARACTERISTICS (continued)

T<sub>A</sub> = +25°C, V<sub>IN</sub> = 18V, L = 22μH and C<sub>OUT</sub> = 22μF, unless otherwise noted.

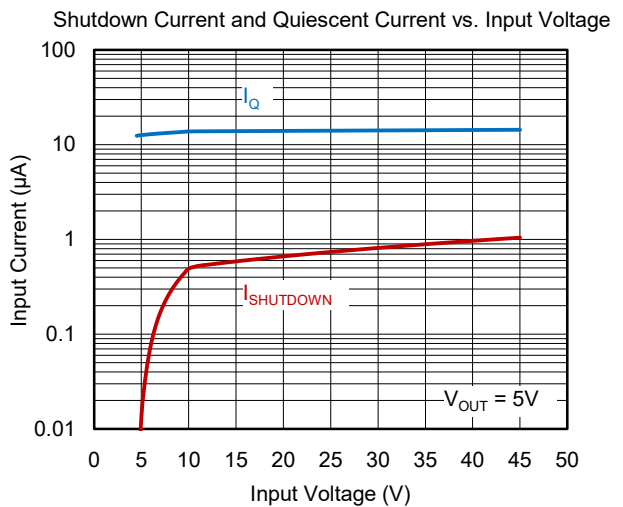
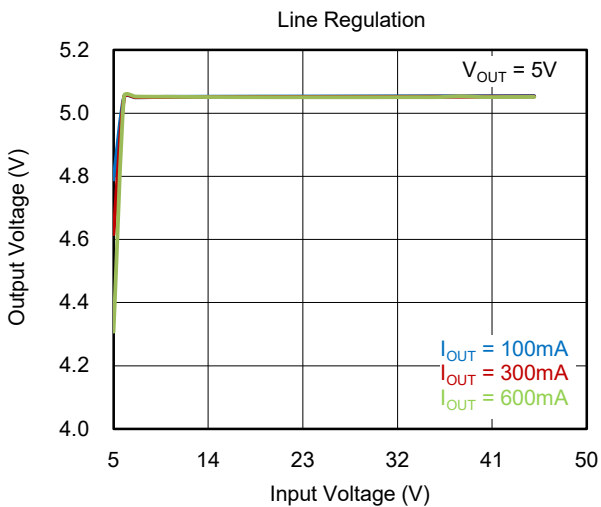
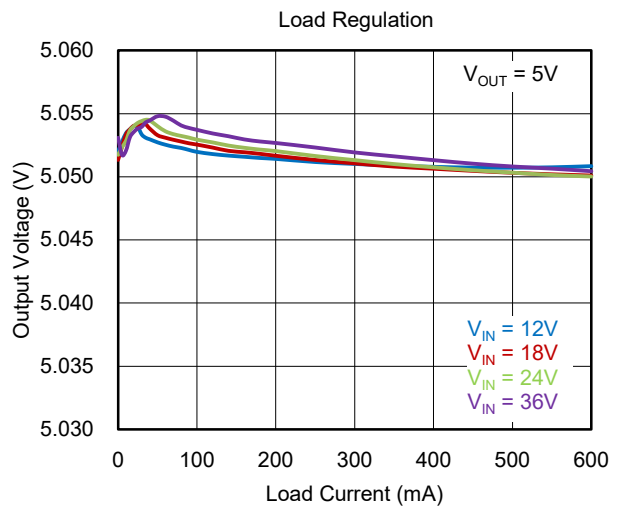
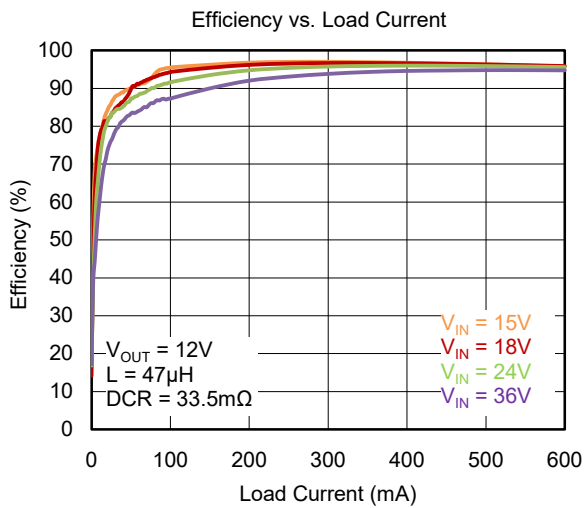
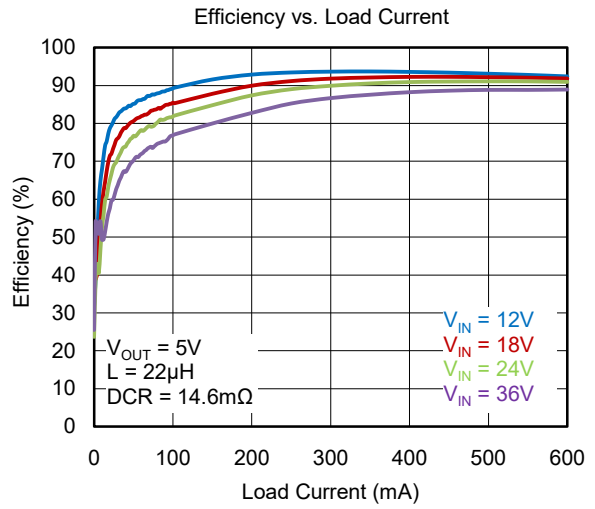
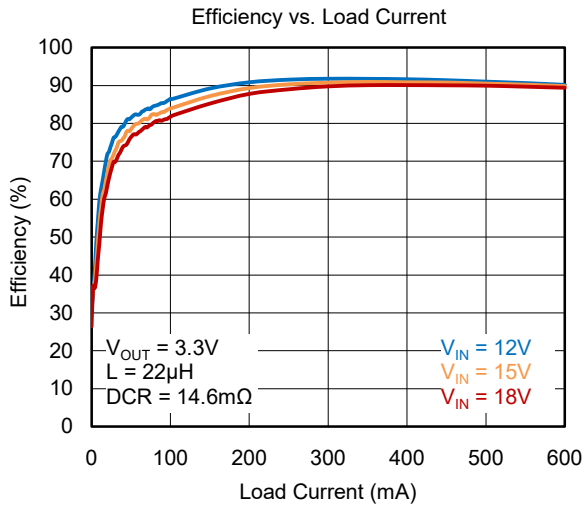

**TYPICAL PERFORMANCE CHARACTERISTICS (continued)**

$T_A = +25^\circ\text{C}$ ,  $V_{IN} = 18\text{V}$ ,  $L = 22\mu\text{H}$  and  $C_{OUT} = 22\mu\text{F}$ , unless otherwise noted.

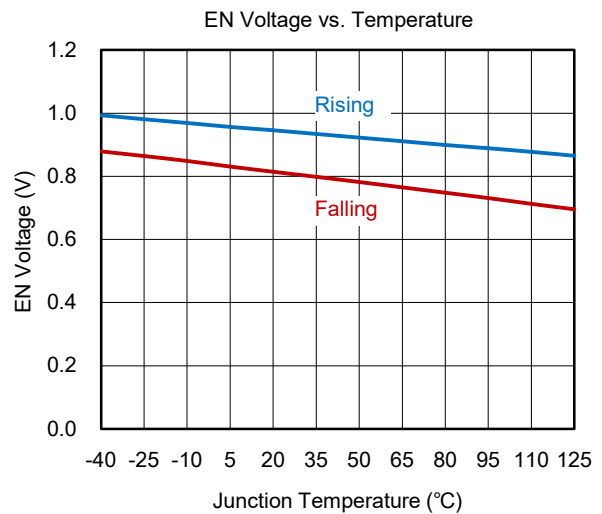
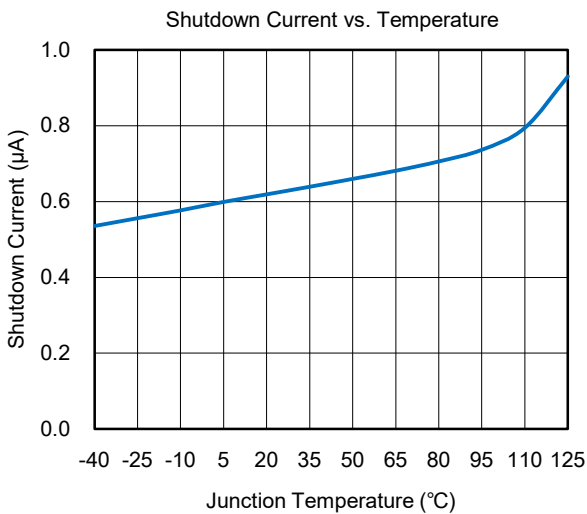
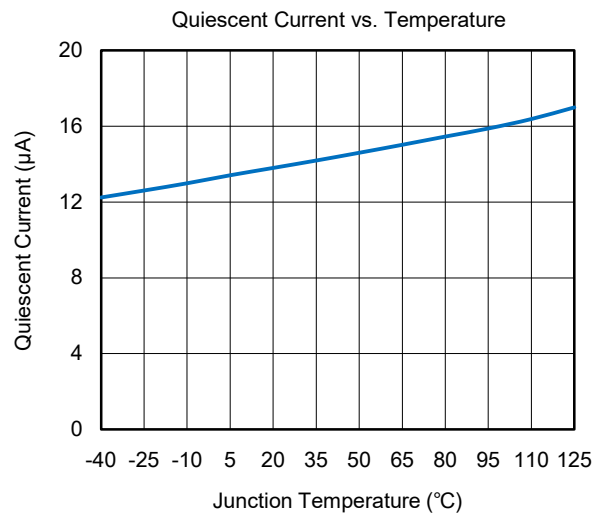
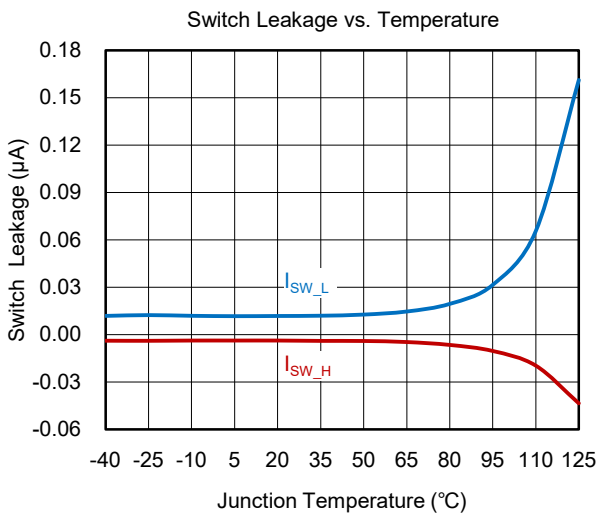
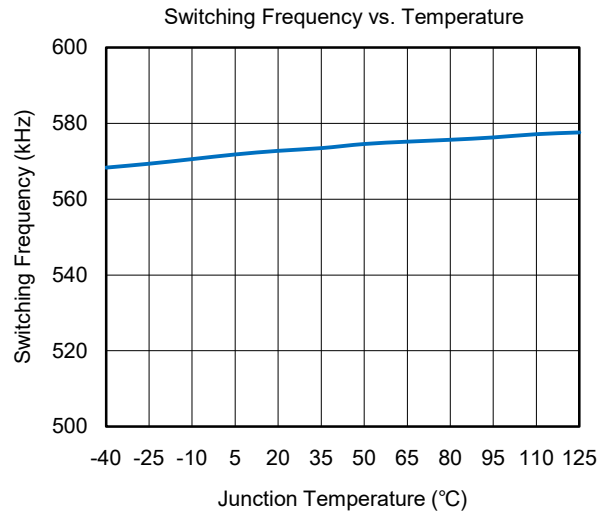
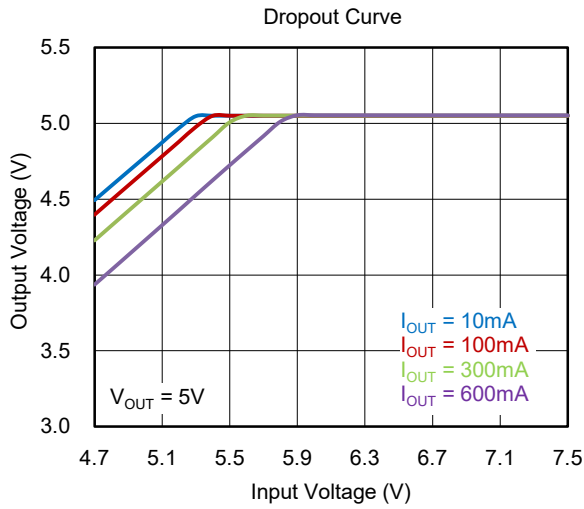



**TYPICAL PERFORMANCE CHARACTERISTICS (continued)**

T<sub>A</sub> = +25°C, V<sub>IN</sub> = 18V, L = 22μH and C<sub>OUT</sub> = 22μF, unless otherwise noted.

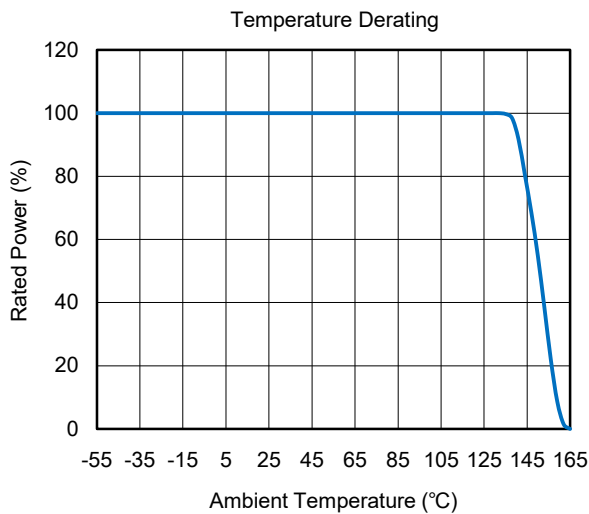
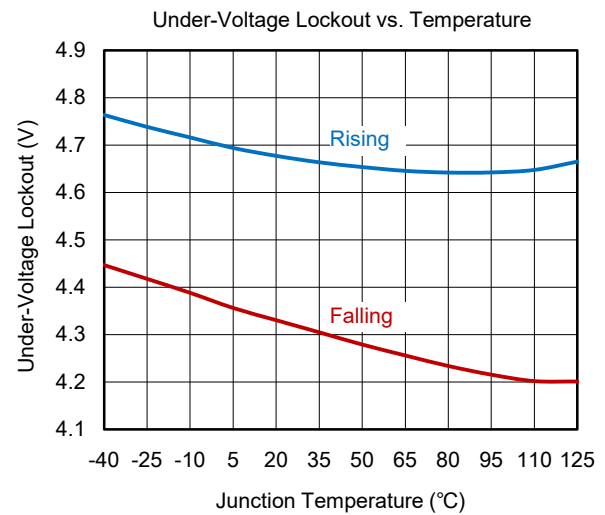
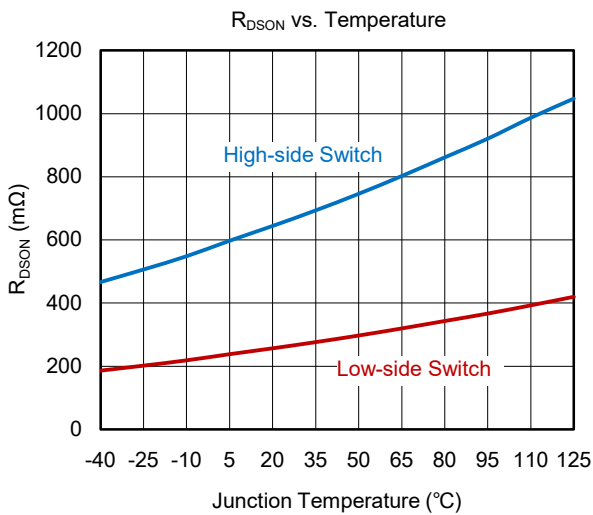
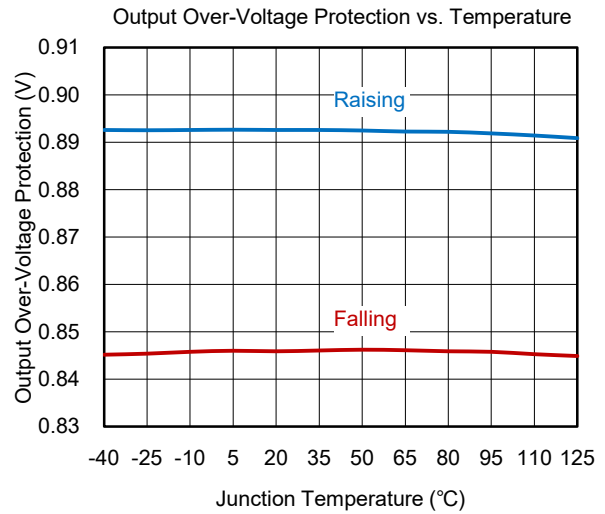
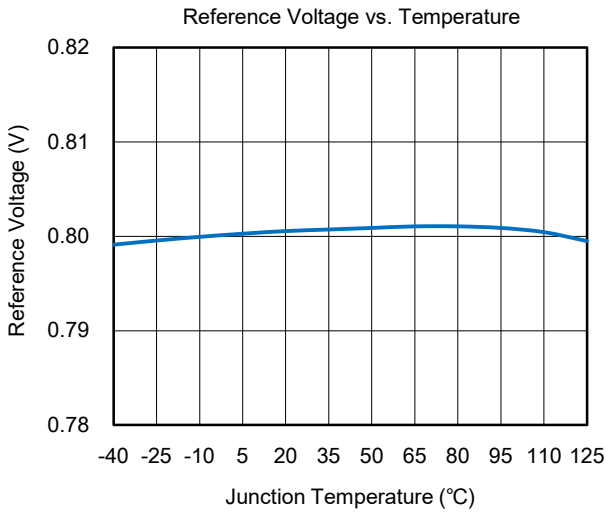



## DETAILED DESCRIPTION

### Overview

The SGM61413 is an internally compensated wide input range current mode controlled synchronous Buck converter. It is designed for high reliability and is particularly suitable for power conditioning from unregulated sources or battery-powered applications that need low sleep/shutdown currents. At no load and with switching stopped, the total operating current is approximately 14 $\mu$ A. If the device is disabled, the total consumption is typically 0.6 $\mu$ A.

Figure 2 shows the simplified block diagram of the SGM61413. The two integrated MOSFET switches of the power stage are both over-current protected and can provide up to 600mA of continuous current for the load. Current limiting of the switches also prevents inductor current runaway. The converter switches are optimized for high efficiency at low duty cycle.

At the beginning of each switching cycle, the high-side switch is turned on. This is the time that feedback voltage ( $V_{FB}$ ) is below the reference voltage ( $V_{REF}$ ) and power must be delivered to the output. After the on-period, the high-side switch is turned off and the low-side switch is turned on until the end of switching cycle. For reliable operation and preventing shoot through, a short dead time is always inserted between gate pulses of the converter complimentary switches. During dead time, both switch gates are kept off.

The device is designed for safe monotonic start-up even if the output is pre-biased.

If the junction temperature exceeds a maximum threshold ( $T_{SHDN}$ , typically +145 $^{\circ}$ C), thermal shutdown protection will happen and switching will stop. The device will automatically recover with soft-start when the junction temperature drops back well below the trip point. This hysteresis is typically 20 $^{\circ}$ C.

The SGM61413 has current limit on both the high-side and low-side MOSFET switches. When current limit is activated, frequency fold-back is also activated. This occurs in the case of output overload or short circuit. Note that SGM61413 will continue to provide its maximum output current and will not shut down or hiccup. In such a case, the junction temperature may rise rapidly and trigger thermal shutdown.

During initial power-up of the device (soft-start), current limit and frequency fold-back are activated to prevent inductor current runaway while the output capacitor is charging to the desired  $V_{OUT}$ .

### Peak-Current Mode (PWM Control)

Figure 2 shows the functional block diagram and Figure 3 shows the switching node operating waveforms of the SGM61413. Switching node voltage is generated by controlling the duty cycles of the complementary high-side and low-side switches. The high-side duty cycle is used as control parameter of the Buck converter to regulate output voltage and is defined as:  $D = t_{ON}/t_{SW}$ , where  $t_{ON}$  is the high-side switch on-time and  $t_{SW}$  is the switching period. When high-side switch is turned on, the SW pin voltage sharply rises towards  $V_{IN}$ , and the inductor current ( $I_L$ ) starts ramping up with  $(V_{IN} - V_{OUT})/L$  slope. When high-side switch is turned off, the low-side switch is turned on after a very short dead time to avoid shoot-through, and  $I_L$  ramps down with  $-V_{OUT}/L$  slope. In ideal case, the output voltage is proportional to the input voltage and duty cycle ( $D = V_{OUT}/V_{IN}$ ) if component parasitics are ignored.

The SGM61413 employs fixed-frequency peak-current mode control in continuous conduction mode (when inductor minimum current is above zero). In light load conditions (when the inductor current reaches zero) the SGM61413 will enter discontinuous conduction mode and the control mode will change to shift frequency, peak-current mode to reduce the switching frequency and the associated switching and gate driving losses (power-save mode).

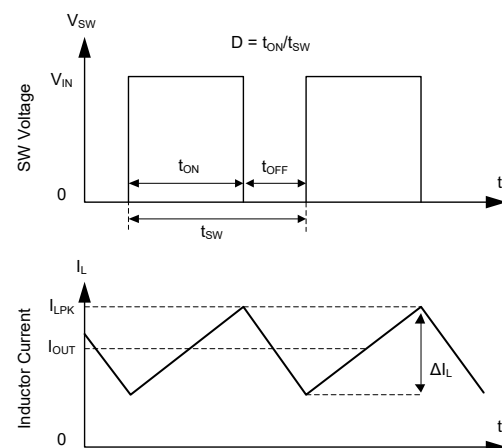

Figure 3. Converter Switching Waveforms in CCM

## DETAILED DESCRIPTION (continued)

In continuous conduction mode, SGM61413 operates at fixed-frequency using peak-current mode control scheme. The controller has an outer voltage feedback loop to get accurate DC voltage regulation. The output of the outer loop is fed to an inner peak-current control loop as reference command that adjusts the peak-current of the inductor. The inductor peak-current is sensed from the high-side switch and is compared to the peak-current reference to control the duty cycle. In other words, as soon as the inductor current reaches the reference peak-current determined by voltage loop, the high-side switch is turned off and the low-side switch is turned on after dead time.

The internally compensated voltage feedback loop allows for simpler design, fewer external components, and stable operation with almost any combination of output capacitors.

### Power-Save Mode

When the load is reduced, the inductor minimum (valley) current eventually reaches zero level (boundary condition). Synchronous rectifier (low-side switch) current is always sensed and when it reaches zero, the controller turns off the low-side switch and does not let the low-side switch sink current. This prevents inductor current from going below zero (negative). This results in discontinuous conduction mode (DCM) operation in which inductor current remains zero until next switching cycle. Both switches are off during this period and do not act as complementary switches. This off-time will extend (that means lower frequency) until output voltage falls below reference voltage again and triggers a new switching cycle. With a new cycle, the high-side switch is turned on again for almost the same  $t_{ON}$  time as CCM. Therefore, the output capacitors take almost the same charge in each cycle and with lighter loads it will take longer off-times until output capacitor voltage falls below the reference voltage. The extended off-times mean lower switching frequency that is called frequency fold-back and significantly reduces the switching losses, but usually increases the output ripple a little bit.

Note that the on-time of synchronous rectifier switch should always be long enough to fully charge the bootstrap capacitor and prevent bootstrap under-voltage lockout due to insufficient voltage for the high-side switch gate driver.

### Floating Driver and Bootstrap Charging UVLO Protection

The high-side MOSFET driver is powered by a floating supply provided by an external bootstrap capacitor. The bootstrap capacitor is charged and regulated to about 5V by the dedicated internal bootstrap regulator. When the voltage between BOOT and SW nodes is below regulation, a PMOS pass transistor turns on and connects VIN and BOOT pins internally, otherwise it will turn off. The power supply for the floating driver has its own UVLO protection. The rising UVLO threshold is about 4.7V and with 380mV hysteresis, the falling threshold is about 4.32V. In case of UVLO, the reference voltage of the controller is reset to zero and after recovery a new soft-start process will start.

### Output Over-Voltage Protection (OVP)

The SGM61413 contains an over-voltage comparator that monitors the FB pin voltage. The over-voltage threshold is approximately 111% of nominal FB voltage. When the voltage at the FB pin exceeds the over-voltage threshold ( $V_{OUT\_OV}$ ), PWM switching will be stopped and both high-side and low-side switches will be turned off. If the over-voltage fault is removed, the regulator will automatically recover.

The error amplifier is normally able to maintain regulation since the synchronous output stage has excellent sink and source capability. However it is not able to regulate output when the FB pin is disconnected or when the output is shorted to a higher supply like input supply. Also when  $V_{OUT}$  is set to its minimum (0.8V) usually there is no voltage divider and  $V_{OUT}$  is directly connected to FB through a resistor ( $R_1$  in the divider) and there is no resistor to ground (no  $R_2$ ). In such case and with no load, an internal current source of  $5\mu A \sim 6\mu A$  from BOOT into the SW pin, which can slowly charge the output capacitor and pull  $V_{OUT}$  up to  $V_{IN}$ . Therefore a minimum load of at least  $10\mu A$  must be always present on  $V_{OUT}$  (for example an  $80k\Omega$  resistor:  $0.8V/10\mu A = 80k\Omega$ ).

If the FB pin is disconnected, a tiny internal current source will force the voltage at the FB pin to rise above  $V_{OUT\_OV}$  that triggers over-voltage protection and disables the regulator to protect the loads from a significant over-voltage. Also, if by accident a higher external voltage is shorted to the output,  $V_{FB}$  will rise above the over-voltage threshold and trigger an OVP event to protect the low-side switch.

**DETAILED DESCRIPTION (continued)****Minimum High-side On/Off-Time and Frequency Fold-Back**

The shortest duration for the high-side switch on-time ( $t_{ON\_MIN}$ ) is 100ns (TYP). For the off-time ( $t_{OFF\_MIN}$ ) the minimum value is 100ns (TYP). The duty cycle (or equivalently the  $V_{OUT}/V_{IN}$  ratio) range in CCM operation is limited by  $t_{ON\_MIN}$  and  $t_{OFF\_MIN}$  depending on the switching frequency. Note that at 570kHz the total cycle time is  $t_{SW} = 1.75\mu s$ .

The minimum and maximum duty cycles without frequency fold-back are given by Equations 1 and 2:

$$D_{MIN} = t_{ON\_MIN} \times f_{SW} \quad (1)$$

and

$$D_{MAX} = 1 - t_{OFF\_MIN} \times f_{SW} \quad (2)$$

For any given output voltage, the highest input voltage without frequency fold-back can be calculated from:

$$V_{IN\_MAX} = \frac{V_{OUT}}{f_{SW} \times t_{ON\_MIN}} \quad (3)$$

The minimum  $V_{IN}$  is estimated by:

$$V_{IN\_MIN} = \frac{V_{OUT}}{1 - f_{SW} \times t_{OFF\_MIN}} \quad (4)$$

**Input Voltage**

The SGM61413 can operate efficiently for inputs as high as 42V. For CCM operation (continuous conduction mode) keep duty cycle between 6% and 94%.

**Output Voltage**

The output voltage can be stepped down to as low as the 0.8V reference voltage ( $V_{REF}$ ). As explained before, when the output voltage is set to 0.8V and there is no voltage divider, a minimum small load will be needed.

An 80k $\Omega$  resistor to ground will prevent the output voltage floating up.

**Soft-Start**

Soft-start is necessary to limit the input inrush current right after power-up or enabling the device. Soft-start is implemented by slowly ramping up the reference voltage that in turn slowly ramps up the output voltage to its target regulation value.

**Enable**

EN pin turns the SGM61413 operation on or off conditions. If an applied voltage less than 0.5V, the device will shut down. If the voltage more than 1.2V, the device will start the regulator. The EN pin is an input and must not be left open. The simplest way to enable the device is to connect the EN pin to  $V_{IN}$  pin via a resistor. This enables the SGM61413 to start up automatically when  $V_{IN}$  is within the operating range. An external logic signal can be used to drive the EN input for power savings, power supply sequencing and/or protection. If the EN pin is driven by an external logic signal, a 10k $\Omega$  resistor in series with the input is recommended.

Note: Voltage on the EN pin should never exceed  $V_{IN} + 0.3V$ . Do not drive the EN pin with a logic level if  $V_{IN}$  is not present. This can damage the EN pin and the device.

**Thermal Shutdown**

Thermal protection is designed to protect the die against overheating damage. If the junction temperature exceeds +145 $^{\circ}C$ , the switching stops and the device shuts down. Automatic recovery with an internal soft-start will begin when the junction temperature drops below the +120 $^{\circ}C$  falling threshold.

TYPICAL APPLICATION CIRCUITS

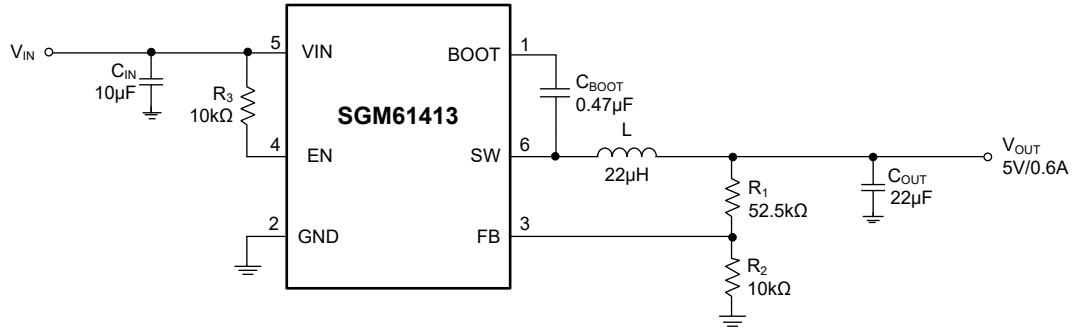

Figure 4. 5V Output Typical Application Circuit

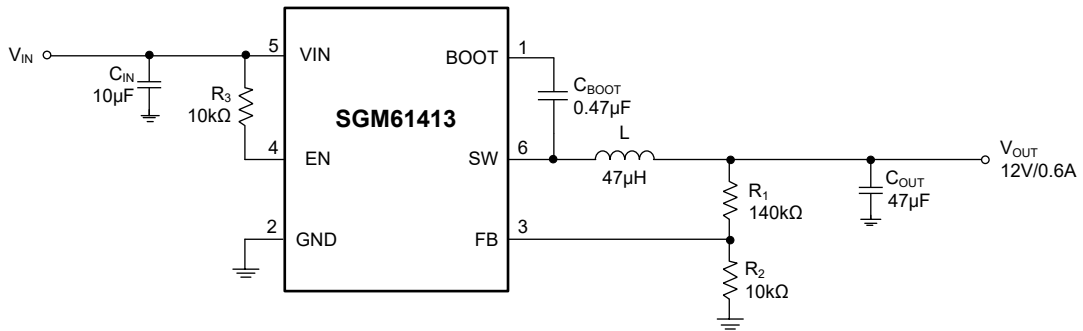

Figure 5. 12V Output Typical Application Circuit

## APPLICATION INFORMATION

### External Components

The following guides can be used to select external components.

f <sub>sw</sub> (kHz)	V <sub>OUT</sub> (V)	R <sub>1</sub> (kΩ)	R <sub>2</sub> (kΩ)	L (μH)	C <sub>BOOT</sub> (μF)	C <sub>IN</sub> (μF)	C <sub>OUT</sub> (μF)
570	3.3	31.2	10	22	0.47	10	22
	5	52.5	10	22	0.47	10	22
	12	140	10	47	0.47	10	47

### Output Voltage Programming

Output voltage can be set with a resistor divider feedback network between output and FB pin as shown in Figure 4 and Figure 5. Usually, a design is started by selecting lower resistor R<sub>1</sub> and calculating R<sub>2</sub> with the following equation:

$$V_{OUT} = V_{REF} \times \left( 1 + \frac{R_1}{R_2} \right) \quad (5)$$

where V<sub>REF</sub> = 0.8V.

To keep operating quiescent current small and prevent voltage errors due to leakage currents, it is recommended to choose R<sub>1</sub> in the range of 10kΩ to 200kΩ.

If the output has no load other than the FB divider, make sure the divider draws at least 10μA from V<sub>OUT</sub> or an internal current source (5μA ~ 6μA) from BOOT to SW will slowly charge the output capacitor beyond the desired voltage.

### Inductor Selection

Higher operating frequency allows the designer to choose smaller inductor and capacitor values; however, the switching and gate losses are increased. On the other hand, at lower frequencies the current ripple (ΔI<sub>L</sub>) is higher, which results in higher light load losses. Use Equation 6 to calculate the required inductance (L<sub>MIN</sub>). K is the ratio of the inductor peak-to-peak ripple (ΔI<sub>L</sub>) to the maximum operating DC current (I<sub>OUT</sub>). The recommended selection range for K is between 0.2 and 0.4. Choosing a higher K value reduces the selected inductance, but a too high K factor may result in insufficient slope compensation. The inductance is selected based on the desired peak-to-peak ripple current (ΔI<sub>L</sub>) for CCM. Equation 7 shows that ΔI<sub>L</sub> is inversely proportional to f<sub>SW</sub> × L and is increased at the maximum input voltage (V<sub>IN\_MAX</sub>). Therefore by accepting larger ΔI<sub>L</sub> values, smaller inductances can be chosen but the cost is higher output voltage ripple and increased core losses.

Inductor peak-current should never exceed the saturation even in transients to avoid over-current protection. Also inductor RMS rating should always be larger than operating RMS current even at maximum ambient temperature.

$$\Delta I_L = \frac{V_{OUT} \times (V_{IN\_MAX} - V_{OUT})}{V_{IN\_MAX} \times L \times f_{SW}} \quad (6)$$

$$L_{MIN} = \frac{V_{IN\_MAX} - V_{OUT}}{I_{OUT} \times K_{IND}} \times \frac{V_{OUT}}{V_{IN\_MAX} \times f_{SW}} \quad (7)$$

where K<sub>IND</sub> = ΔI<sub>L</sub>/I<sub>OUT</sub> (DC Current, MAX).

Note that it is generally desired to choose a smaller inductance value to have faster transient response, smaller size, and lower DCR. On the other hand, if the inductance is too small, current ripple will increase which can trigger over-current protection. Larger inductor current ripple also implies larger output voltage ripple with the same output capacitors. For peak-current mode control, it is recommended to choose large current ripple, because controller comparator performs better with higher signal to noise ratio. So, for this design example, K<sub>IND</sub> = 0.4 is chosen, and the minimum inductor value for 12V input voltage is calculated to be 21.7μH. The nearest standard value would be a 22μH ferrite inductor with a 1A RMS current rating and 1.5A saturation current that are well above the designed converter output current RMS and DC respectively.

### Bootstrap Capacitor Selection

The SGM61413 requires a small external bootstrap capacitor, C<sub>BOOT</sub>, between the BOOT and SW pins to provide the gate drive supply voltage for the high-side MOSFET. The bootstrap capacitor is refreshed when the high-side MOSFET is off and the low-side switch conducts. An X7R or X5R 0.47μF ceramic capacitor with a voltage rating of 16V or higher is recommended for stable operating performance over-temperature and voltage variations.

## APPLICATION INFORMATION (continued)

### Input Capacitor Selection

The input capacitor also provides the high frequency switching transient currents. So, choosing a low-ESR and small size capacitor with high self-resonance frequency and sufficient RMS rating is necessary. The recommended high frequency decoupling capacitor value is 10 $\mu$ F X5R or X7R or higher. It is recommended to choose the voltage rating of the capacitor(s) at least twice the maximum input voltage to avoid derating of the ceramic capacitors with DC voltage. Some bulk capacitances may be needed, especially if the SGM61413 is not located within 5cm distance from the input voltage source for input stability.

Bulk capacitors have high Equivalent Series Resistance (ESR) and can provide the damping needed to prevent input voltage spiking due to the wiring inductance of the input. The value for this capacitor is not critical but must be rated to handle the maximum input voltage including ripple.

For this design, one 10 $\mu$ F, X7R, 50V is used for the input decoupling capacitor. The ESR is approximately 10m $\Omega$ , and the current rating is 1A. To improve high frequency filtering, a small parallel 0.1 $\mu$ F capacitor may be placed as close as possible to the device pins.

### Output Capacitor Selection

This device is designed to be used with external LC filters. The minimum required capacitance to keep cost and size down and bandwidth high. The main factors for designing  $C_{OUT}$  are output voltage ripple, control loop stability and the magnitude of output voltage overshoot/undershoot after a load transients. So,  $C_{OUT}$  should be chosen carefully. The output voltage ripple has two main components. One is due to the ac current ( $\Delta I_L$ ) going through the capacitor ESR:

$$\Delta V_{OUT\_ESR} = \Delta I_L \times ESR = K_{IND} \times I_{OUT} \times ESR \quad (8)$$

and the other one is caused by the charge and discharge of capacitor by the ac current ( $\Delta I_L$ ):

$$\Delta V_{OUT\_C} = \frac{\Delta I_L}{8 \times f_{SW} \times C_{OUT}} = \frac{K_{IND} \times I_{OUT}}{8 \times f_{SW} \times C_{OUT}} \quad (9)$$

These AC components are not in phase and the total peak-to-peak ripple is less than  $\Delta V_{OUT\_ESR} + \Delta V_{OUT\_C}$ .

Transient performance specification usually limits output capacitance if the system requires tight voltage regulation in presence of large current steps and/or fast slew rate. The output capacitor must provide the increased load current or absorb the excess inductor current (when the load current steps down) until the control loop can re-adjust the current of the inductor to the new load level. The control loop of regulator usually requires 8 or more clock cycles to adjust the inductance current to the new load level. The output capacitance must be as large as possible to provide a current difference of 8 clock cycles to keep the output voltage within the specified range. Equation 10 shows the minimum output capacitance required to specify output overshoot/undershoot.

$$C_{OUT} > \frac{1}{2} \times \frac{8 \times (I_{OH} - I_{OL})}{f_{SW} \times \Delta V_{OUT\_SHOOT}} \quad (10)$$

where:

$I_{OL}$  = Low level of the output current step during load transient.

$I_{OH}$  = High level of the output current during load transient.

$V_{OUT\_SHOOT}$  = Target output voltage over/undershoot.

In this example, maximum acceptable ripple is 30mV. Assuming  $\Delta V_{OUT\_ESR} = \Delta V_{OUT\_C} = 30mV$  and  $K_{IND} = 0.4$ . Equation 8 results in  $ESR < 125m\Omega$  and Equation 9 leads to  $C_{OUT} > 1.8\mu F$ . If the overshoot/undershoot transient requirement is 5% then  $\Delta V_{OUT\_SHOOT} = 5\% \times V_{OUT} = 250mV$ . Equations 10, half load (0.3A) to full load (0.6A) transient, lead to  $C_{OUT} > 8.6\mu F$ . So, in summary, the most stringent criteria for the output capacitor is transient constrain of  $C_{OUT} > 8.6\mu F$ . For the derating margin, one 22 $\mu$ F, 10V, X7R ceramic capacitor with 10m $\Omega$  ESR is used.



APPLICATION INFORMATION (continued)

Layout Guide

Careful layout is always important to ensure good performance and stable operation to any kind of switching regulator. Place the capacitors close to the device, use the GND pin of the device as the center of star-connection to other grounds, and minimize the trace area of the SW node. With smaller transient current loops, lower parasitic ringing will be achieved.

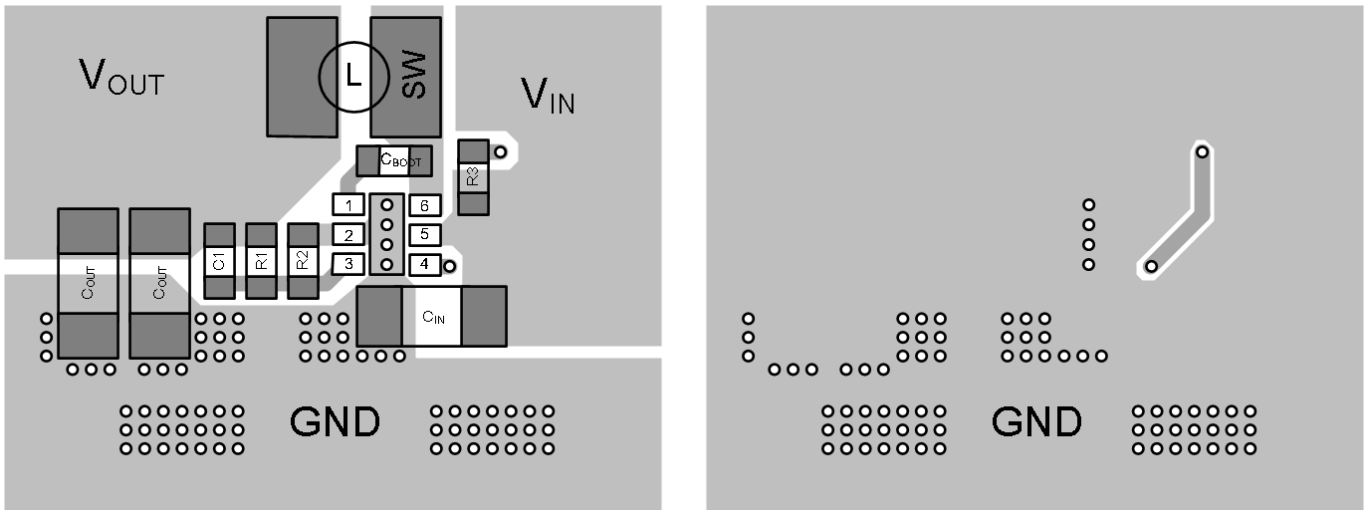

Figure 6. Suggested PCB

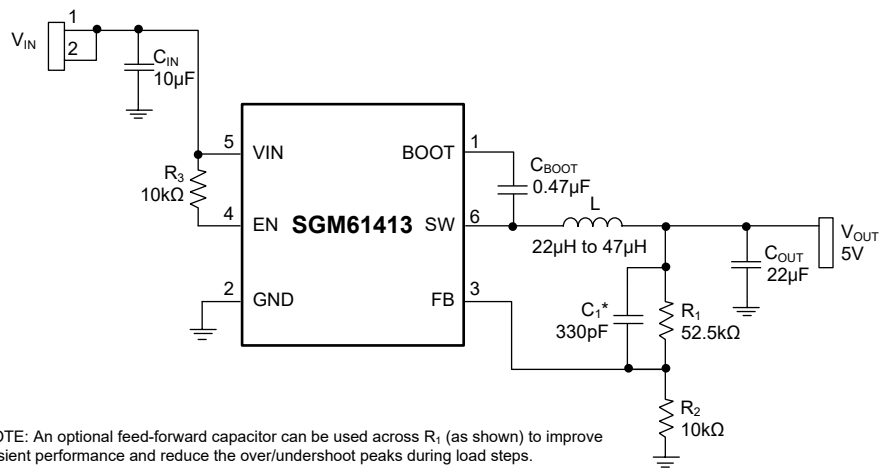

Figure 7. Typical Application Circuit

**REVISION HISTORY**

NOTE: Page numbers for previous revisions may differ from page numbers in the current version.

<b>MAY 2022 – REV.A to REV.A.1</b>	<b>Page</b>
Updated Detailed Description and Application Information sections.....	11 to 17

---

<b>Changes from Original (MARCH 2021) to REV.A</b>	<b>Page</b>
Changed from product preview to production data.....	All

---

# PACKAGE INFORMATION

## PACKAGE OUTLINE DIMENSIONS

### SOT-23-6

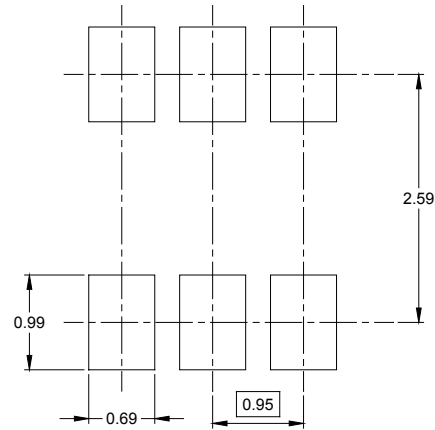
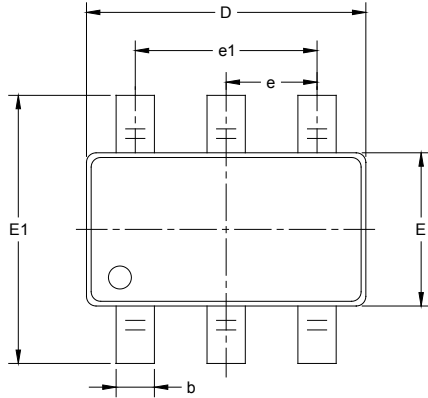

RECOMMENDED LAND PATTERN (Unit: mm)

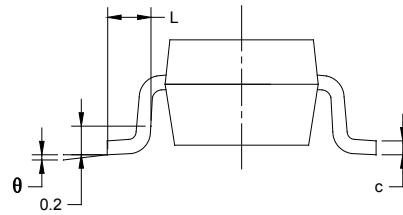
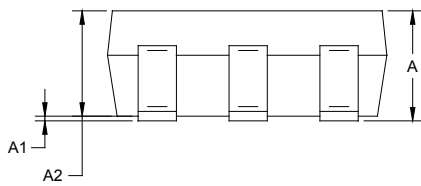

Symbol	Dimensions In Millimeters		Dimensions In Inches	
	MIN	MAX	MIN	MAX
A	1.050	1.250	0.041	0.049
A1	0.000	0.100	0.000	0.004
A2	1.050	1.150	0.041	0.045
b	0.300	0.500	0.012	0.020
c	0.100	0.200	0.004	0.008
D	2.820	3.020	0.111	0.119
E	1.500	1.700	0.059	0.067
E1	2.650	2.950	0.104	0.116
e	0.950 BSC		0.037 BSC	
e1	1.900 BSC		0.075 BSC	
L	0.300	0.600	0.012	0.024
$\theta$	0°	8°	0°	8°

# PACKAGE INFORMATION

## TAPE AND REEL INFORMATION

### REEL DIMENSIONS

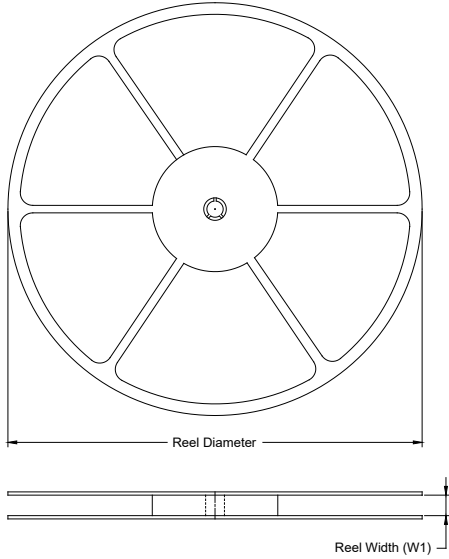

### TAPE DIMENSIONS

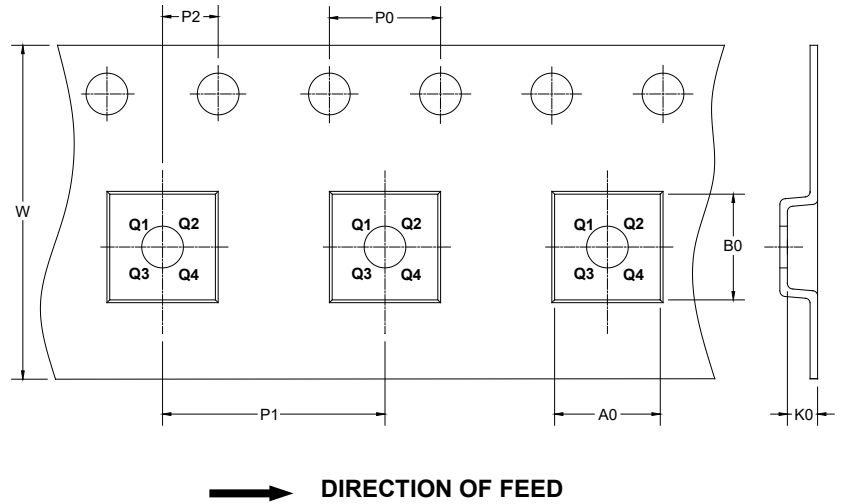

NOTE: The picture is only for reference. Please make the object as the standard.

### KEY PARAMETER LIST OF TAPE AND REEL

Package Type	Reel Diameter	Reel Width W1 (mm)	A0 (mm)	B0 (mm)	K0 (mm)	P0 (mm)	P1 (mm)	P2 (mm)	W (mm)	Pin1 Quadrant
SOT-23-6	7"	9.5	3.17	3.23	1.37	4.0	4.0	2.0	8.0	Q3

DD0001

# PACKAGE INFORMATION

## CARTON BOX DIMENSIONS



NOTE: The picture is only for reference. Please make the object as the standard.

## KEY PARAMETER LIST OF CARTON BOX

Reel Type	Length (mm)	Width (mm)	Height (mm)	Pizza/Carton
7" (Option)	368	227	224	8
7"	442	410	224	18

DD0002