

74LV1T08

Single 2-Input Translating AND Gate

GENERAL DESCRIPTION

The 74LV1T08 is a single level translating 2-input AND gate that is designed for 1.6V to 5.5V V_{CC} operation. The input is designed with a low threshold circuit to match 1.8V input logic at $V_{CC} = 3.3V$ and can be used in 1.8V to 3.3V level up translation. In addition, the 5V tolerant input pins enable level down translation (for example, 3.3V to 2.5V output at $V_{CC} = 2.5V$). The output level is referenced to the supply voltage and supports 1.8V, 2.5V, 3.3V and 5.0V CMOS levels. The wide V_{CC} range allows the generation of output levels to connect to controllers or processors.

APPLICATIONS

Portable Applications
 PC and Notebooks
 Automotive
 Industrial Controllers
 Telecom

FEATURES

- **Single Supply Voltage Translator at 1.8V, 2.5V, 3.3V and 5.0V**
- **Up Translation:**
 - ♦ 1.2V to 1.8V at $V_{CC} = 1.8V$
 - ♦ 1.5V to 2.5V at $V_{CC} = 2.5V$
 - ♦ 1.8V to 3.3V at $V_{CC} = 3.3V$
 - ♦ 3.3V to 5.0V at $V_{CC} = 5.0V$
- **Down Translation:**
 - ♦ 3.3V to 1.8V at $V_{CC} = 1.8V$
 - ♦ 3.3V to 2.5V at $V_{CC} = 2.5V$
 - ♦ 5.0V to 3.3V at $V_{CC} = 3.3V$
- **5V Tolerant Inputs**
- **-40°C to +125°C Operating Temperature Range**
- **Available in a Green SC70-5 Package**

LOGIC SYMBOL

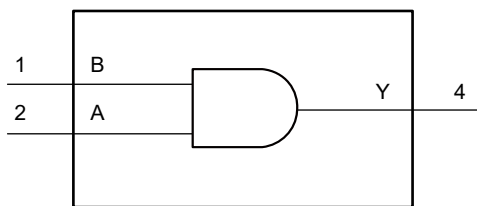

LOGIC DIAGRAM

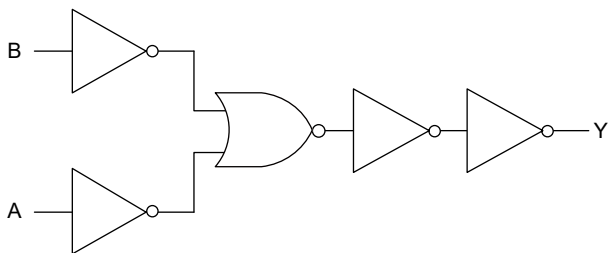

FUNCTION TABLE

INPUT		OUTPUT
A	B	Y
L	L	L
L	H	L
H	L	L
H	H	H

$$Y = A \cdot B \text{ or } Y = \overline{\overline{A} + \overline{B}}$$

H = High Voltage Level

L = Low Voltage Level

PACKAGE/ORDERING INFORMATION

MODEL	PACKAGE DESCRIPTION	SPECIFIED TEMPERATURE RANGE	ORDERING NUMBER	PACKAGE MARKING	PACKING OPTION
74LV1T08	SC70-5	-40°C to +125°C	74LV1T08XC5G/TR	R59XX	Tape and Reel, 3000

MARKING INFORMATION

NOTE: XX = Date Code.

YYY X X

Date Code - Week

Date Code - Year

Serial Number

Green (RoHS & HSF): SG Micro Corp defines "Green" to mean Pb-Free (RoHS compatible) and free of halogen substances. If you have additional comments or questions, please contact your SGMICRO representative directly.

ABSOLUTE MAXIMUM RATINGS ⁽¹⁾

Supply Voltage, V_{CC}	-0.5V to 7V
Input Voltage, V_I ⁽²⁾	-0.5V to 7V
Output Voltage, V_O ⁽²⁾	
Output in High-State or Low-State ⁽³⁾	-0.5V to $V_{CC} + 0.5V$
Output in Power-Off State.....	-0.5V to 0.5V
Input Clamping Current, I_{IK} ($V_I < 0V$).....	-20mA
Output Clamping Current, I_{OK} ($V_O > V_{CC}$ or $V_O < 0V$).....	$\pm 20mA$
Output Current, I_O ($V_O = 0V$ to V_{CC}).....	$\pm 25mA$
Supply Current, I_{CC}	25mA
Ground Current, I_{GND}	-25mA
Junction Temperature ⁽⁴⁾	+150°C
Storage Temperature Range.....	-65°C to +150°C
Lead Temperature (Soldering, 10s).....	+260°C
ESD Susceptibility	
HBM.....	4000V
CDM.....	1000V

RECOMMENDED OPERATING CONDITIONS

Supply Voltage, V_{CC}	1.6V to 5.5V
Input Voltage, V_I	0V to 5.5V
Output Voltage, V_O	
Output in High-State or Low-State.....	0V to V_{CC}
Input Transition Rise and Fall Rate, $\Delta t/\Delta V$	
$V_{CC} = 1.8V$ to $5.5V$	20ns/V (MAX)
Operating Temperature Range.....	-40°C to +125°C

OVERSTRESS CAUTION

1. Stresses beyond those listed in Absolute Maximum Ratings may cause permanent damage to the device. Exposure to absolute maximum rating conditions for extended periods may affect reliability. Functional operation of the device at any conditions beyond those indicated in the Recommended Operating Conditions section is not implied.
2. The input and output voltage ratings may be exceeded if the input and output clamp current ratings are observed.
3. This value is limited to 7V maximum.
4. The performance capability of a high-performance integrated circuit in conjunction with its thermal environment can create junction temperatures which are detrimental to reliability.

ESD SENSITIVITY CAUTION

This integrated circuit can be damaged if ESD protections are not considered carefully. SGMICRO recommends that all integrated circuits be handled with appropriate precautions. Failure to observe proper handling and installation procedures can cause damage. ESD damage can range from subtle performance degradation to complete device failure. Precision integrated circuits may be more susceptible to damage because even small parametric changes could cause the device not to meet the published specifications.

DISCLAIMER

SG Micro Corp reserves the right to make any change in circuit design, or specifications without prior notice.

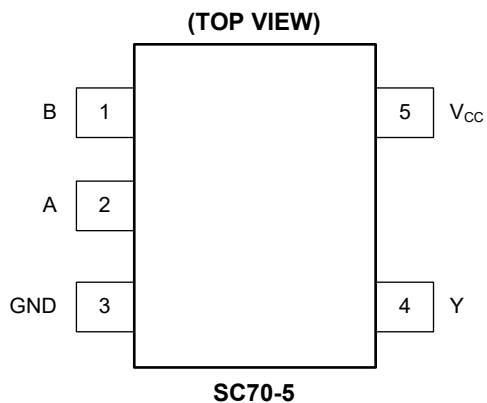
PIN CONFIGURATION**PIN DESCRIPTION**

PIN	NAME	FUNCTION
1, 2	B, A	Data Inputs.
3	GND	Ground.
4	Y	Data Output.
5	V _{cc}	Supply Voltage.

ELECTRICAL CHARACTERISTICS(Full = -40°C to +125°C, all typical values are measured at $T_A = +25^\circ\text{C}$, unless otherwise noted.)

PARAMETER	SYMBOL	CONDITIONS	TEMP	MIN	TYP	MAX	UNITS	
High-Level Input Voltage	V_{IH}	$V_{CC} = 1.65\text{V to } 1.8\text{V}$	Full	1			V	
		$V_{CC} = 2.0\text{V}$	Full	1.03				
		$V_{CC} = 2.25\text{V to } 2.5\text{V}$	Full	1.18				
		$V_{CC} = 2.75\text{V}$	Full	1.23				
		$V_{CC} = 3.0\text{V to } 3.3\text{V}$	Full	1.37				
		$V_{CC} = 3.6\text{V}$	Full	1.48				
		$V_{CC} = 4.5\text{V to } 5.0\text{V}$	Full	2.03				
		$V_{CC} = 5.5\text{V}$	Full	2.11				
Low-Level Input Voltage	V_{IL}	$V_{CC} = 1.65\text{V to } 2.0\text{V}$	Full			0.55	V	
		$V_{CC} = 2.25\text{V to } 2.75\text{V}$	Full			0.71		
		$V_{CC} = 3.0\text{V to } 3.6\text{V}$	Full			0.65		
		$V_{CC} = 4.5\text{V to } 5.5\text{V}$	Full			0.8		
High-Level Output Voltage	V_{OH}	$V_I = V_{IH} \text{ or } V_{IL}$	$V_{CC} = 1.65\text{V to } 5.5\text{V}, I_O = -20\mu\text{A}$	Full	$V_{CC} - 0.05$	$V_{CC} - 0.01$	V	
			$V_{CC} = 1.65\text{V}, I_O = -2\text{mA}$	Full	1.39	1.53		
			$V_{CC} = 1.8\text{V}, I_O = -2\text{mA}$	Full	1.56	1.7		
			$V_{CC} = 2.3\text{V}, I_O = -2.3\text{mA}$	Full	2.08	2.22		
			$V_{CC} = 2.3\text{V}, I_O = -3\text{mA}$	Full	2.06	2.18		
			$V_{CC} = 2.5\text{V}, I_O = -3\text{mA}$	Full	2.28	2.4		
			$V_{CC} = 3.0\text{V}, I_O = -3\text{mA}$	Full	2.8	2.92		
			$V_{CC} = 3.0\text{V}, I_O = -5.5\text{mA}$	Full	2.7	2.85		
			$V_{CC} = 3.3\text{V}, I_O = -5.5\text{mA}$	Full	3.02	3.16		
			$V_{CC} = 4.5\text{V}, I_O = -4\text{mA}$	Full	4.3	4.42		
			$V_{CC} = 4.5\text{V}, I_O = -8\text{mA}$	Full	4.2	4.35		
$V_{CC} = 5.0\text{V}, I_O = -8\text{mA}$	Full	4.72	4.86					
Low-Level Output Voltage	V_{OL}	$V_I = V_{IH} \text{ or } V_{IL}$	$V_{CC} = 1.65\text{V to } 5.5\text{V}, I_O = 20\mu\text{A}$	Full		0.01	0.05	V
			$V_{CC} = 1.65\text{V}, I_O = 2\text{mA}$	Full		0.08	0.2	
			$V_{CC} = 2.3\text{V}, I_O = 2.3\text{mA}$	Full		0.06	0.15	
			$V_{CC} = 2.3\text{V}, I_O = 3\text{mA}$	Full		0.08	0.2	
			$V_{CC} = 3.0\text{V}, I_O = 3\text{mA}$	Full		0.06	0.15	
			$V_{CC} = 3.0\text{V}, I_O = 5.5\text{mA}$	Full		0.12	0.24	
			$V_{CC} = 4.5\text{V}, I_O = 4\text{mA}$	Full		0.08	0.2	
			$V_{CC} = 4.5\text{V}, I_O = 8\text{mA}$	Full		0.14	0.35	
Input Leakage Current	I_I	$V_{CC} = 0\text{V to } 5.5\text{V}, V_I = V_{CC} \text{ or } \text{GND}$	Full		± 0.01	± 1	μA	
Supply Current	I_{CC}	$V_{CC} = 1.8\text{V}, 2.5\text{V}, 3.3\text{V}, 5.0\text{V}, V_I = V_{CC} \text{ or } \text{GND}, I_O = 0\text{A}$	Full		0.01	2	μA	
Additional Supply Current	ΔI_{CC}	Per input pin, $V_{CC} = 1.8\text{V}, V_I = 0.3\text{V or } 1.1\text{V}, I_O = 0\text{A}, \text{ other pins at } V_{CC} \text{ or } \text{GND}$	Full		0.1	5	μA	
		Per input pin, $V_{CC} = 5.5\text{V}, V_I = 0.3\text{V or } 3.4\text{V}, I_O = 0\text{A}, \text{ other pins at } V_{CC} \text{ or } \text{GND}$	Full		0.4	1	mA	

DYNAMIC CHARACTERISTICS(For test circuit, see Figure 1. Full = -40°C to +125°C, all typical values are measured at T_A = +25°C, unless otherwise noted.)

PARAMETER	SYMBOL	CONDITIONS	TEMP	MIN ⁽¹⁾	TYP	MAX ⁽¹⁾	UNITS	
Propagation Delay ⁽²⁾	t _{PD}	A, B to Y, see Figure 2	V _{CC} = 1.8V, C _L = 15pF	Full	0.5	7.9	15.5	ns
			V _{CC} = 1.8V, C _L = 30pF	Full	0.5	8.7	18	
			V _{CC} = 2.5V, C _L = 15pF	Full	0.5	5	9.5	
			V _{CC} = 2.5V, C _L = 30pF	Full	0.5	5.3	10	
			V _{CC} = 3.3V, C _L = 15pF	Full	0.1	3.9	7	
			V _{CC} = 3.3V, C _L = 30pF	Full	0.1	4	7.8	
			V _{CC} = 5.0V, C _L = 15pF	Full	0.1	2.9	4.5	
			V _{CC} = 5.0V, C _L = 30pF	Full	0.1	3.2	5.2	
Input Capacitance	C _I	V _I = V _{CC} or GND, V _{CC} = 3.3V	+25°C		4		pF	
Output Capacitance	C _O	V _{CC} = 0V, V _O = GND	+25°C		9		pF	
Power Dissipation Capacitance ⁽³⁾	C _{PD}	Per buffer, V _I = GND to V _{CC} , C _L = 30pF, f = 10MHz	V _{CC} = 1.8V	+25°C		6		pF
			V _{CC} = 2.5V	+25°C		5.5		
			V _{CC} = 3.3V	+25°C		5.5		
			V _{CC} = 5.0V	+25°C		6		

NOTES:

- Specified by design and characterization; not production tested.
- t_{PD} is the same as t_{PLH} and t_{PHL}.
- C_{PD} is used to determine the dynamic power dissipation (P_D in μW).

$$P_D = C_{PD} \times V_{CC}^2 \times f_i \times N + \Sigma(C_L \times V_{CC}^2 \times f_o)$$
 where:
 f_i = Input frequency in MHz.
 f_o = Output frequency in MHz.
 C_L = Output load capacitance in pF.
 V_{CC} = Supply voltage in Volts.
 N = Number of inputs switching.
 Σ(C_L × V_{CC}² × f_o) = Sum of the outputs.

TEST CIRCUIT

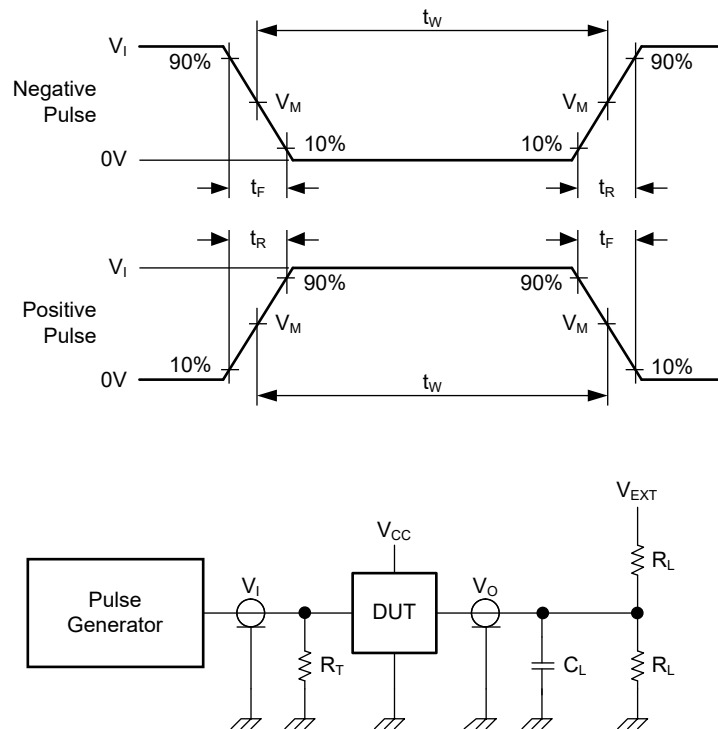

Test conditions are given in Table 1.

Definitions test circuit:

R_L = Load resistance.

C_L = Load capacitance including jig and probe capacitance.

R_T = Termination resistance should be equal to output impedance Z_O of the pulse generator.

V_{EXT} = External voltage for measuring switching times.

Figure 1. Test Circuit for Measuring Switching Times

Table 1. Test Conditions

SUPPLY VOLTAGE	INPUT			LOAD		V_{EXT}
V_{CC}	V_I	$\Delta t/\Delta V$ ⁽¹⁾	f_{MAX}	C_L	R_L	t_{PLH}, t_{PHL}
1.8V	V_{CC}	$\leq 1.0\text{ns/V}$	15MHz	15pF, 30pF	1M Ω	GND
2.5V	V_{CC}	$\leq 1.0\text{ns/V}$	25MHz	15pF, 30pF	1M Ω	GND
3.3V	3V	$\leq 1.0\text{ns/V}$	50MHz	15pF, 30pF	1M Ω	GND
5.0V	3V	$\leq 1.0\text{ns/V}$	50MHz	15pF, 30pF	1M Ω	GND

NOTE:

1. $dV/dt \geq 1.0\text{V/ns}$.

WAVEFORMS

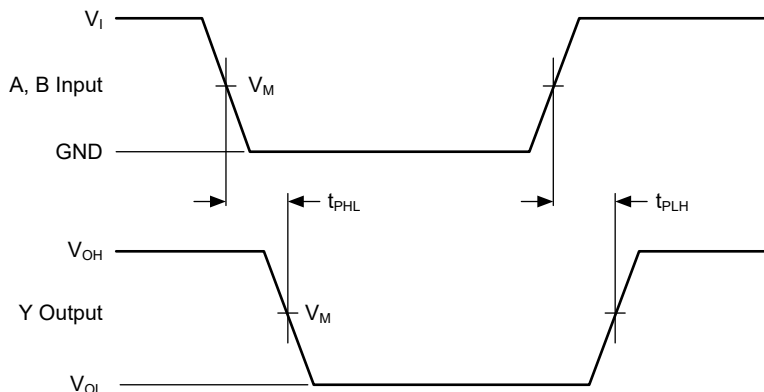

Test conditions are given in Table 1.

Measurement points are given in Table 2.

Logic levels: V_{OL} and V_{OH} are typical voltage output levels that occur with the output load.

Figure 2. The Input A, B to Output Y Propagation Delays

Table 2. Measurement Points

INPUT	OUTPUT
$V_M^{(1)}$	V_M
$0.5 \times V_I$	$0.5 \times V_{CC}$

NOTE:

1. The measurement points should be V_{IH} or V_{IL} when the input rising or falling time exceeds 1.0ns.

REVISION HISTORY

NOTE: Page numbers for previous revisions may differ from page numbers in the current version.

NOVEMBER 2021 – REV.A to REV.A.1	Page
Updated Dynamic Characteristics section.....	5
Added note of Table 2	7

Changes from Original (FEBRUARY 2021) to REV.A	Page
Changed from product preview to production data.....	All

PACKAGE INFORMATION

PACKAGE OUTLINE DIMENSIONS

SC70-5

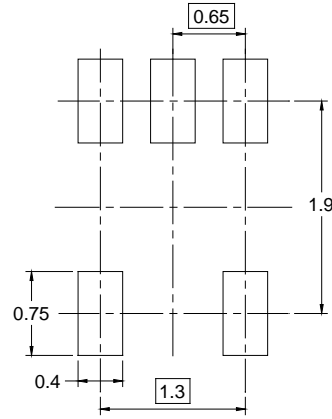

RECOMMENDED LAND PATTERN (Unit: mm)

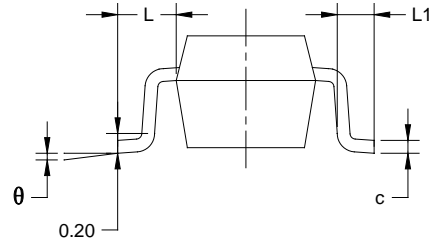
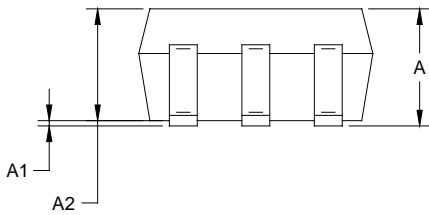

Symbol	Dimensions In Millimeters		Dimensions In Inches	
	MIN	MAX	MIN	MAX
A	0.800	1.100	0.031	0.043
A1	0.000	0.100	0.000	0.004
A2	0.800	1.000	0.031	0.039
b	0.150	0.350	0.006	0.014
c	0.080	0.220	0.003	0.009
D	2.000	2.200	0.079	0.087
E	1.150	1.350	0.045	0.053
E1	2.150	2.450	0.085	0.096
e	0.65 TYP		0.026 TYP	
e1	1.300 BSC		0.051 BSC	
L	0.525 REF		0.021 REF	
L1	0.260	0.460	0.010	0.018
θ	0°	8°	0°	8°

NOTES:

1. Body dimensions do not include mode flash or protrusion.
2. This drawing is subject to change without notice.

PACKAGE INFORMATION

TAPE AND REEL INFORMATION

REEL DIMENSIONS



TAPE DIMENSIONS



NOTE: The picture is only for reference. Please make the object as the standard.

KEY PARAMETER LIST OF TAPE AND REEL

Package Type	Reel Diameter	Reel Width W1 (mm)	A0 (mm)	B0 (mm)	K0 (mm)	P0 (mm)	P1 (mm)	P2 (mm)	W (mm)	Pin1 Quadrant
SC70-5	7"	9.5	2.25	2.55	1.20	4.0	4.0	2.0	8.0	Q3

DD0001

PACKAGE INFORMATION

CARTON BOX DIMENSIONS



NOTE: The picture is only for reference. Please make the object as the standard.

KEY PARAMETER LIST OF CARTON BOX

Reel Type	Length (mm)	Width (mm)	Height (mm)	Pizza/Carton
7" (Option)	368	227	224	8
7"	442	410	224	18

DD0002