

SGM2210

300mA, Low Quiescent Current and Low Noise Linear Regulator

GENERAL DESCRIPTION

The SGM2210 is a low quiescent current, low noise and low dropout voltage linear regulator. It is capable of supplying 300mA output current with typical dropout voltage of 240mV. The operating input voltage range is from 2.5V to 20V. The fixed output voltage range is from 1.2V to 5.0V and adjustable output voltage range is from 1.2V to 12V.

Other features include logic-controlled shutdown mode, short-circuit current limit and thermal shutdown protection. The SGM2210 has automatic discharge function to quickly discharge V_{OUT} in the disabled status.

The SGM2210 is available in a Green SOT-23-5 package. It operates over an operating temperature range of -40°C to +125°C.

FEATURES

- Operating Input Voltage Range: 2.5V to 20V
- Fixed Outputs of 1.2V, 1.8V, 2.5V, 3.3V and 5.0V
- Adjustable Output from 1.2V to 12V
- 300mA Output Current
- Output Voltage Accuracy: $\pm 1\%$ at +25°C
- Quiescent Current: 36 μ A (TYP)
- Low Dropout: 80mV (TYP) at 100mA, $V_{OUT} = 3.3V$
- Low Noise: 48 μ V_{RMS} (TYP) at $V_{OUT} = 3.3V$
- High PSRR: 100dB (TYP) at 1kHz
- Current Limiting and Thermal Protection
- With Output Automatic Discharge
- Stable with Small Case Size Ceramic Capacitors
- Shutdown Supply Current: 0.5 μ A (TYP)
- -40°C to +125°C Operating Temperature Range
- Available in a Green SOT-23-5 Package

APPLICATIONS

Palmtop Computers
Portable Electronics
Industrial and Medical Equipment
Battery-Powered Equipment

TYPICAL APPLICATION

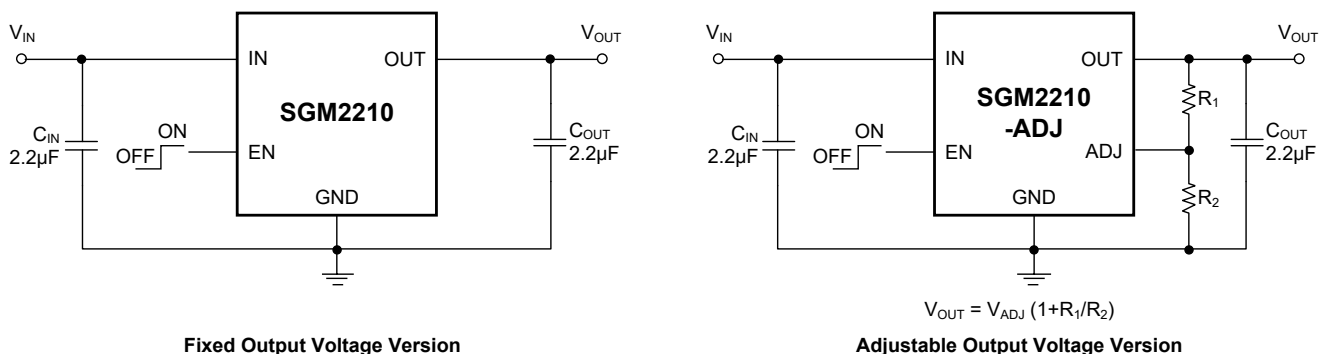

Figure 1. Typical Application Circuits

PACKAGE/ORDERING INFORMATION

| MODEL | V _{OUT} (V) | PACKAGE DESCRIPTION | SPECIFIED TEMPERATURE RANGE | ORDERING NUMBER | PACKAGE MARKING | PACKING OPTION |
|-------------|----------------------|---------------------|-----------------------------|--------------------|-----------------|---------------------|
| SGM2210-1.2 | 1.2 | SOT-23-5 | -40°C to +125°C | SGM2210-1.2XN5G/TR | CC0XX | Tape and Reel, 3000 |
| SGM2210-1.8 | 1.8 | SOT-23-5 | -40°C to +125°C | SGM2210-1.8XN5G/TR | CC6XX | Tape and Reel, 3000 |
| SGM2210-2.5 | 2.5 | SOT-23-5 | -40°C to +125°C | SGM2210-2.5XN5G/TR | CCDXX | Tape and Reel, 3000 |
| SGM2210-3.3 | 3.3 | SOT-23-5 | -40°C to +125°C | SGM2210-3.3XN5G/TR | MWDXX | Tape and Reel, 3000 |
| SGM2210-5.0 | 5.0 | SOT-23-5 | -40°C to +125°C | SGM2210-5.0XN5G/TR | MWEXX | Tape and Reel, 3000 |
| SGM2210-ADJ | Adjustable | SOT-23-5 | -40°C to +125°C | SGM2210-ADJXN5G/TR | MWFXX | Tape and Reel, 3000 |

MARKING INFORMATION

NOTE: XX = Date Code.

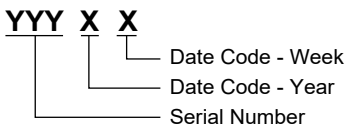

Green (RoHS & HSF): SG Micro Corp defines "Green" to mean Pb-Free (RoHS compatible) and free of halogen substances. If you have additional comments or questions, please contact your SGMICRO representative directly.

ABSOLUTE MAXIMUM RATINGS

- DC Input Voltage Range -0.3V to 22V
- DC Output Voltage Range -0.3V to V_{IN} + 0.3V
- Enable Input Voltage Range -0.3V to V_{IN} + 0.3V
- ADJ Pin Voltage Range -0.3V to 2V
- Output Current Internally Limited
- Package Thermal Resistance
- SOT-23-5, θ_{JA} 170°C/W
- SOT-23-5, θ_{JB} 38°C/W
- SOT-23-5, θ_{JC} 52°C/W
- Junction Temperature +150°C
- Storage Temperature Range -65°C to +150°C
- Lead Temperature (Soldering, 10s) +260°C
- ESD Susceptibility
- HBM 8000V
- CDM 1000V

RECOMMENDED OPERATING CONDITIONS

- Input Voltage Range 2.5V to 20V
- Input Effective Capacitance, C_{IN} 1µF (MIN)
- Output Effective Capacitance, C_{OUT} 1µF to 22µF
- Operating Junction Temperature Range -40°C to +125°C

OVERSTRESS CAUTION

Stresses beyond those listed in Absolute Maximum Ratings may cause permanent damage to the device. Exposure to absolute maximum rating conditions for extended periods may affect reliability. Functional operation of the device at any conditions beyond those indicated in the Recommended Operating Conditions section is not implied.

ESD SENSITIVITY CAUTION

This integrated circuit can be damaged if ESD protections are not considered carefully. SGMICRO recommends that all integrated circuits be handled with appropriate precautions. Failure to observe proper handling and installation procedures can cause damage. ESD damage can range from subtle performance degradation to complete device failure. Precision integrated circuits may be more susceptible to damage because even small parametric changes could cause the device not to meet the published specifications.

DISCLAIMER

SG Micro Corp reserves the right to make any change in circuit design, or specifications without prior notice.

PIN CONFIGURATIONS

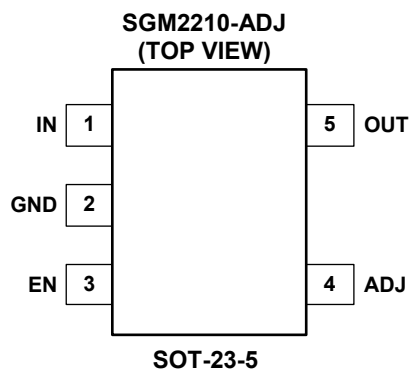
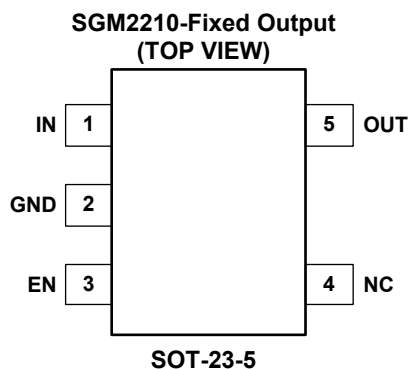

PIN DESCRIPTION

| PIN | NAME | FUNCTION |
|-----|------|---|
| 1 | IN | Input Supply Voltage Pin. It is recommended to use a 2.2 μ F or larger ceramic capacitor from IN pin to ground to get good power supply decoupling. This ceramic capacitor should be placed as close as possible to IN pin. |
| 2 | GND | Ground. |
| 3 | EN | Enable Pin. Drive EN high to turn on the regulator. Drive EN low to turn off the regulator. |
| 4 | NC | No Connection (fixed voltage version only). |
| | ADJ | Feedback Voltage Input Pin (adjustable voltage version only). Connect this pin to the midpoint of an external resistor divider to adjust the output voltage. Place the resistors as close as possible to this pin. |
| 5 | OUT | Regulator Output Pin. It is recommended to use a ceramic capacitor with effective capacitance in the range of 1 μ F to 22 μ F to ensure stability. This ceramic capacitor should be placed as close as possible to OUT pin. |

ELECTRICAL CHARACTERISTICS

(Fixed version, $V_{IN} = V_{OUT(NOM)} + 1V$, $V_{EN} = V_{IN}$, $I_{OUT} = 1mA$, $C_{IN} = C_{OUT} = 2.2\mu F$, $T_J = -40^\circ C$ to $+125^\circ C$, typical values are at $T_J = +25^\circ C$, unless otherwise noted.)

| PARAMETER | SYMBOL | CONDITIONS | TEMP | MIN | TYP | MAX | UNITS |
|--------------------------------|--|--|-----------------|------|--------|-------|---------------|
| Operating Input Voltage | V_{IN} | | +25°C | 2.5 | | 20 | V |
| Output Voltage Accuracy | V_{OUT} | $I_{OUT} = 1mA$ | +25°C | -1 | | 1 | % |
| | | $I_{OUT} = 1mA$ to 300mA | -40°C to +125°C | -1.5 | | 1.5 | |
| Line Regulation | $\frac{\Delta V_{OUT}}{\Delta V_{IN} \times V_{OUT}}$ | $V_{IN} = (V_{OUT(NOM)} + 1V)$ to 20V, $I_{OUT} = 1mA$ | +25°C | | 0.001 | 0.005 | % / V |
| | | | -40°C to +125°C | | | 0.01 | |
| Load Regulation | $\frac{\Delta V_{OUT}}{V_{OUT} \times \Delta I_{OUT}}$ | $I_{OUT} = 1mA$ to 300mA | +25°C | | 0.0005 | 0.001 | % / mA |
| | | | -40°C to +125°C | | | 0.003 | |
| Dropout Voltage ⁽¹⁾ | V_{DROP} | $I_{OUT} = 100mA$, $V_{OUT} = 3.3V$ | +25°C | | 80 | 95 | mV |
| | | | -40°C to +125°C | | | 130 | |
| | | $I_{OUT} = 300mA$, $V_{OUT} = 3.3V$ | +25°C | | 240 | 280 | |
| | | | -40°C to +125°C | | | 380 | |
| Output Voltage Noise | e_n | $f = 10Hz$ to 100kHz, $I_{OUT} = 10mA$, $V_{OUT} = 3.3V$ | +25°C | | 48 | | μV_{RMS} |
| Power Supply Rejection Ratio | PSRR | $V_{IN} = V_{OUT(NOM)} + 1V$, $\Delta V_{RIPPLE} = 0.2V_{P-P}$ $f = 1kHz$, $I_{OUT} = 10mA$, $V_{OUT} = 3.3V$ | +25°C | | 100 | | dB |
| | | $V_{IN} = V_{OUT(NOM)} + 1V$, $\Delta V_{RIPPLE} = 0.2V_{P-P}$ $f = 10kHz$, $I_{OUT} = 10mA$, $V_{OUT} = 3.3V$ | +25°C | | 82 | | |
| Quiescent Current | I_Q | $V_{IN} = (V_{OUT(NOM)} + 1V)$ to 20V, $I_{OUT} = 0mA$ | +25°C | | 36 | 50 | μA |
| | | | -40°C to +125°C | | | 60 | |
| | | $V_{IN} = (V_{OUT(NOM)} + 1V)$ to 20V, $I_{OUT} = 300mA$ | +25°C | | 620 | 720 | |
| | | | -40°C to +125°C | | | 760 | |
| Shutdown Current | I_{SHDN} | $V_{EN} = GND$ | +25°C | | 0.5 | 1 | μA |
| | | | -40°C to +125°C | | | 1.5 | |
| Output Current Limit | I_{LIMIT} | $V_{OUT} = 90\%V_{OUT(NOM)}$ | +25°C | 550 | 900 | | mA |
| Short Circuit Current | I_{SHORT} | $V_{OUT} = 0V$ | +25°C | | 600 | | mA |
| Enable Input Logic Low | V_{IL} | $V_{IN} = 2.5V$ to 20V | -40°C to +125°C | | | 0.4 | V |
| Enable Input Logic High | V_{IH} | $V_{IN} = 2.5V$ to 20V | -40°C to +125°C | 1.3 | | | |
| EN Pin Input Current | I_{EN} | $V_{EN} = V_{IN}$ | +25°C | | 300 | 600 | nA |
| | | | -40°C to +125°C | | | 1000 | |
| Output Discharge Resistance | R_{DIS} | $V_{IN} = 2.5V$, $V_{EN} = 0V$ | +25°C | | 95 | | Ω |
| Thermal Shutdown Temperature | T_{SHDN} | | | | 155 | | °C |
| Thermal Shutdown Hysteresis | ΔT_{SHDN} | | | | 20 | | °C |

NOTE:

1. The dropout voltage is defined as the difference between V_{IN} and V_{OUT} when V_{OUT} falls to $95\% \times V_{OUT(NOM)}$.

ELECTRICAL CHARACTERISTICS (continued)

(Adjustable version, $V_{IN} = V_{OUT(NOM)} + 1V$, $V_{EN} = V_{IN}$, $I_{OUT} = 1mA$, $C_{IN} = C_{OUT} = 2.2\mu F$, $T_J = -40^\circ C$ to $+125^\circ C$, typical values are at $T_J = +25^\circ C$, unless otherwise noted.)

| PARAMETER | SYMBOL | CONDITIONS | TEMP | MIN | TYP | MAX | UNITS |
|--------------------------------|--|---|--|-------|--------|-------|---------------|
| Operating Input Voltage | V_{IN} | | +25°C | 2.5 | | 20 | V |
| Adjustable Voltage | V_{FB} | | +25°C | | 1.2 | | V |
| Adjustable Voltage Accuracy | | $I_{OUT} = 1mA$ | +25°C | -1 | | 1 | % |
| | | $I_{OUT} = 1mA$ to 300mA | -40°C to +125°C | -1.5 | | 1.5 | |
| Line Regulation | $\frac{\Delta V_{OUT}}{\Delta V_{IN} \times V_{OUT}}$ | $V_{IN} = (V_{OUT(NOM)} + 1V)$ to 20V, $I_{OUT} = 1mA$ | +25°C | | 0.001 | 0.005 | %V |
| | | | -40°C to +125°C | | | 0.01 | |
| Load Regulation | $\frac{\Delta V_{OUT}}{V_{OUT} \times \Delta I_{OUT}}$ | $I_{OUT} = 1mA$ to 300mA | +25°C | | 0.0005 | 0.001 | %/mA |
| | | | -40°C to +125°C | | | 0.003 | |
| Dropout Voltage ⁽¹⁾ | V_{DROP} | $I_{OUT} = 100mA$, $V_{OUT} = 3.3V$ | +25°C | | 80 | 95 | mV |
| | | | -40°C to +125°C | | | 130 | |
| | | $I_{OUT} = 300mA$, $V_{OUT} = 3.3V$ | +25°C | | 240 | 280 | |
| | | | -40°C to +125°C | | | 380 | |
| Output Voltage Noise | e_n | $f = 10Hz$ to 100kHz, $I_{OUT} = 10mA$, $V_{OUT} = 3.3V$ | +25°C | | 48 | | μV_{RMS} |
| ADJ Pin Current | I_{ADJ} | | +25°C | | 1 | 3 | nA |
| | | | -40°C to +125°C | | | 5 | |
| Power Supply Rejection Ratio | PSRR | $V_{IN} = V_{OUT(NOM)} + 1V$, $\Delta V_{RIPPLE} = 0.2V_{P-P}$ $f = 1kHz$, $I_{OUT} = 10mA$, $V_{OUT} = 3.3V$ | +25°C | | 100 | | dB |
| | | | $V_{IN} = V_{OUT(NOM)} + 1V$, $\Delta V_{RIPPLE} = 0.2V_{P-P}$ $f = 10kHz$, $I_{OUT} = 10mA$, $V_{OUT} = 3.3V$ | +25°C | | 82 | |
| Quiescent Current | I_Q | $V_{IN} = (V_{OUT(NOM)} + 1V)$ to 20V, $I_{OUT} = 0mA$ | +25°C | | 36 | 50 | μA |
| | | | -40°C to +125°C | | | 60 | |
| | | $V_{IN} = (V_{OUT(NOM)} + 1V)$ to 20V, $I_{OUT} = 300mA$ | +25°C | | 620 | 720 | |
| | | | -40°C to +125°C | | | 760 | |
| Shutdown Current | I_{SHDN} | $V_{EN} = GND$ | +25°C | | 0.5 | 1 | μA |
| | | | -40°C to +125°C | | | 1.5 | |
| Output Current Limit | I_{LIMIT} | $V_{OUT} = 90\%V_{OUT(NOM)}$ | +25°C | 550 | 900 | | mA |
| Short Circuit Current | I_{SHORT} | $V_{OUT} = 0V$ | +25°C | | 600 | | mA |
| Enable Input Logic Low | V_{IL} | $V_{IN} = 2.5V$ to 20V | -40°C to +125°C | | | 0.4 | V |
| Enable Input Logic High | V_{IH} | $V_{IN} = 2.5V$ to 20V | -40°C to +125°C | 1.3 | | | |
| EN Pin Input Current | I_{EN} | $V_{EN} = V_{IN}$ | +25°C | | 300 | 600 | nA |
| | | | -40°C to +125°C | | | 1000 | |
| Output Discharge Resistance | R_{DIS} | $V_{IN} = 2.5V$, $V_{EN} = 0V$ | +25°C | | 95 | | Ω |
| Thermal Shutdown Temperature | T_{SHDN} | | | | 155 | | °C |
| Thermal Shutdown Hysteresis | ΔT_{SHDN} | | | | 20 | | °C |

NOTE:

1. The dropout voltage is defined as the difference between V_{IN} and V_{OUT} when V_{OUT} falls to $95\% \times V_{OUT(NOM)}$.

TYPICAL PERFORMANCE CHARACTERISTICS

$T_J = +25^\circ\text{C}$, $V_{IN} = V_{OUT(NOM)} + 1\text{V}$, $V_{EN} = V_{IN}$, $C_{IN} = C_{OUT} = 2.2\mu\text{F}$, unless otherwise noted.

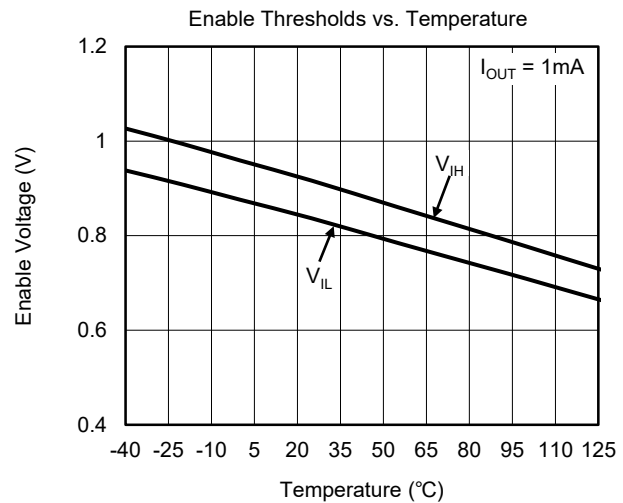
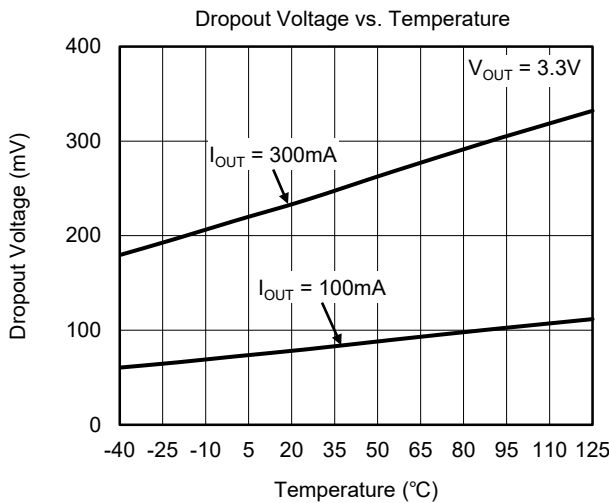
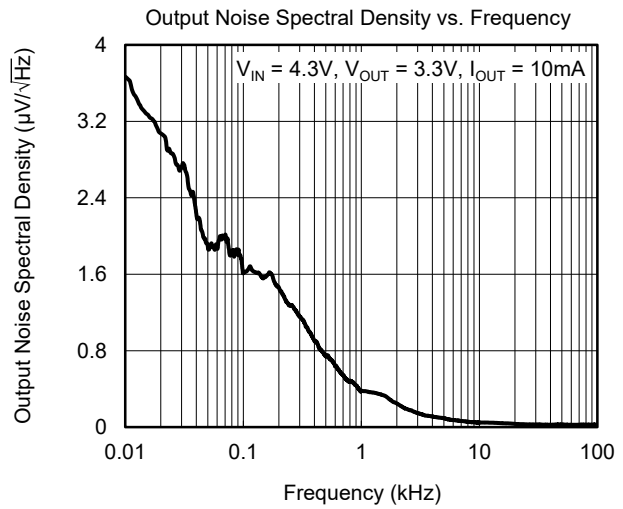
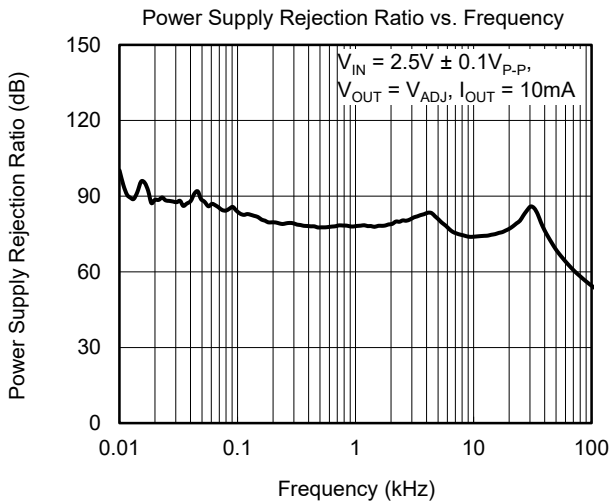
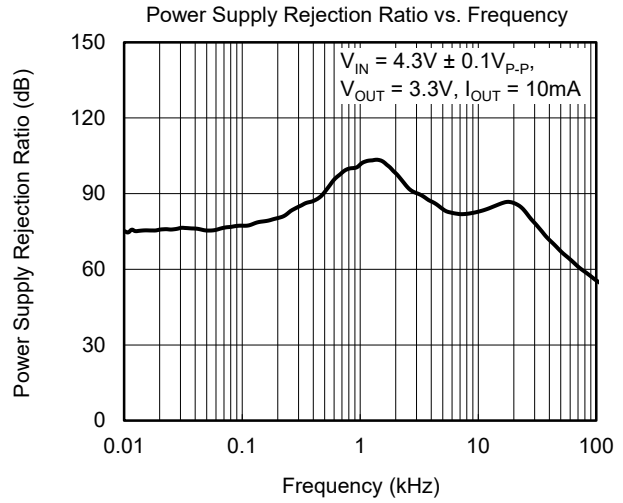
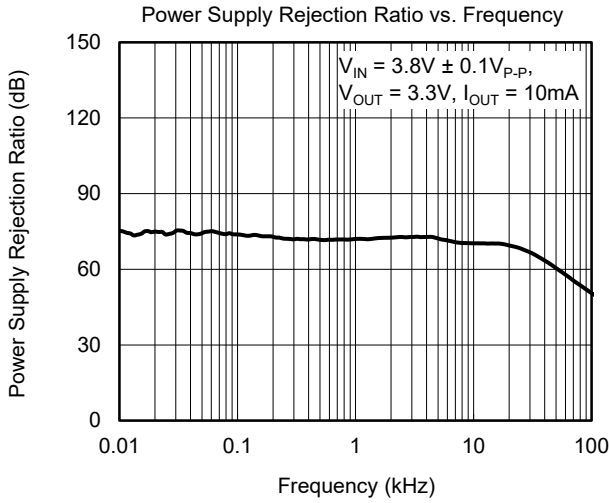

TYPICAL PERFORMANCE CHARACTERISTICS (continued)

$T_J = +25^\circ\text{C}$, $V_{IN} = V_{OUT(NOM)} + 1\text{V}$, $V_{EN} = V_{IN}$, $C_{IN} = C_{OUT} = 2.2\mu\text{F}$, unless otherwise noted.

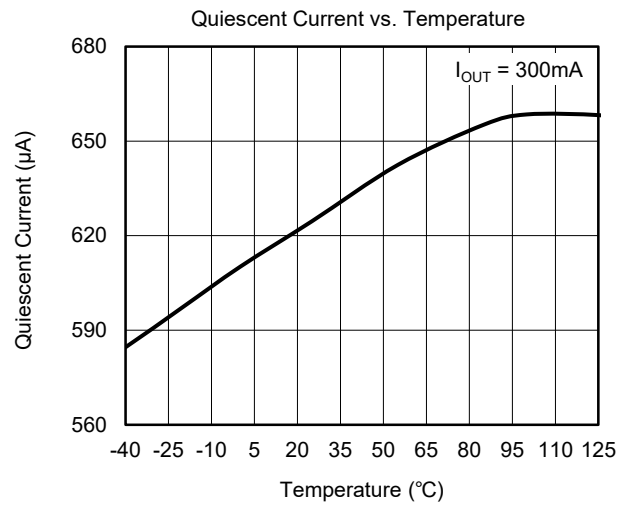
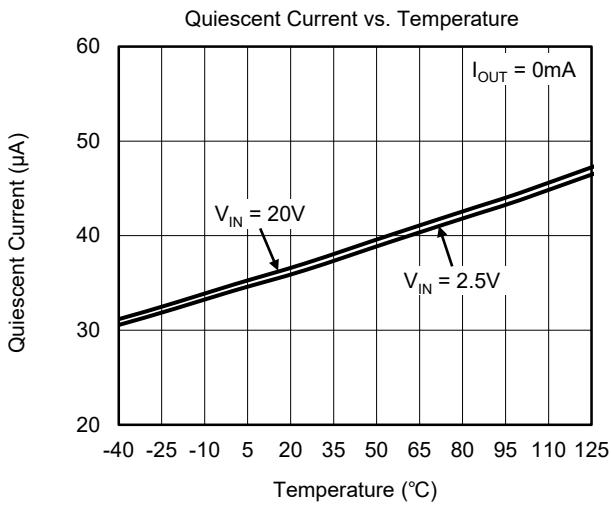
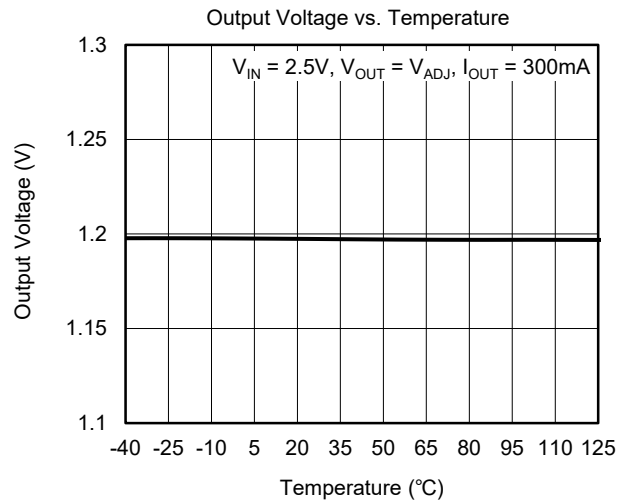
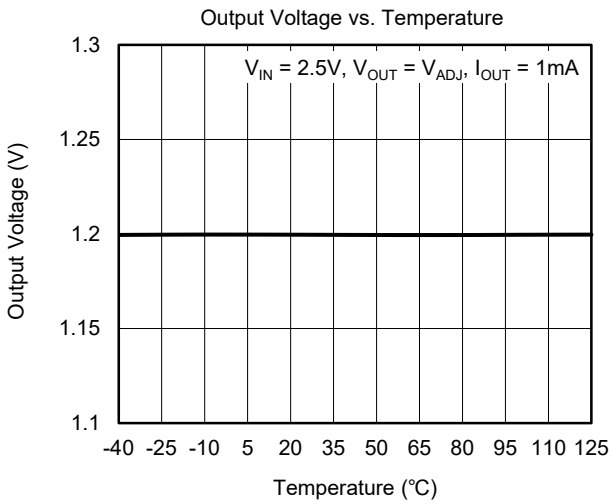
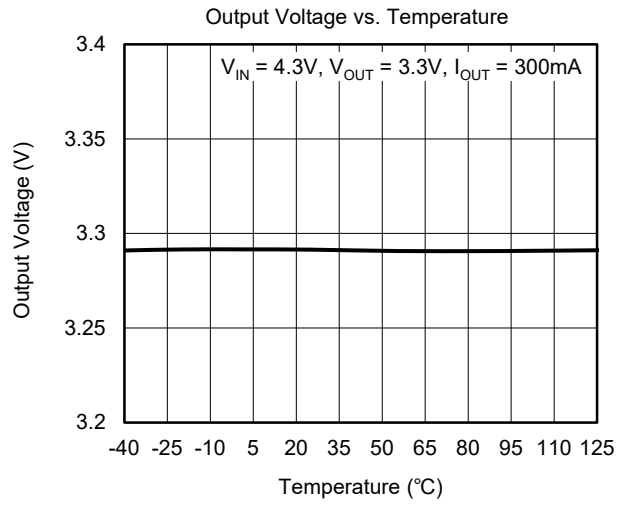
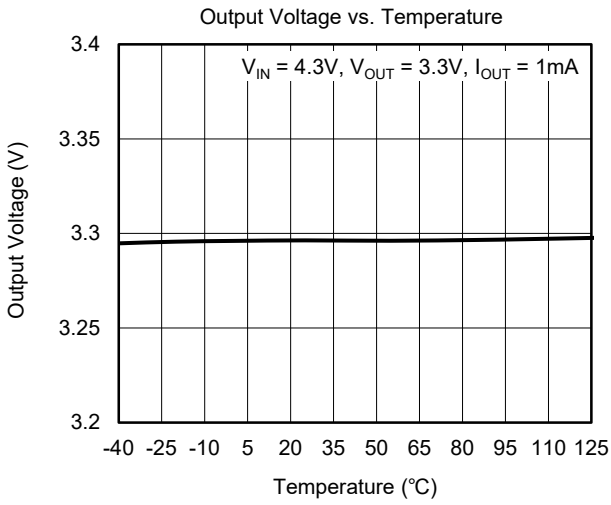

TYPICAL PERFORMANCE CHARACTERISTICS (continued)

$T_J = +25^\circ\text{C}$, $V_{IN} = V_{OUT(NOM)} + 1\text{V}$, $V_{EN} = V_{IN}$, $C_{IN} = C_{OUT} = 2.2\mu\text{F}$, unless otherwise noted.

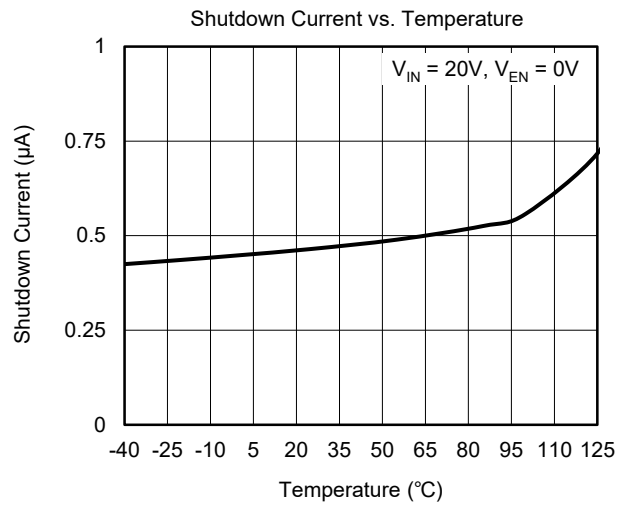
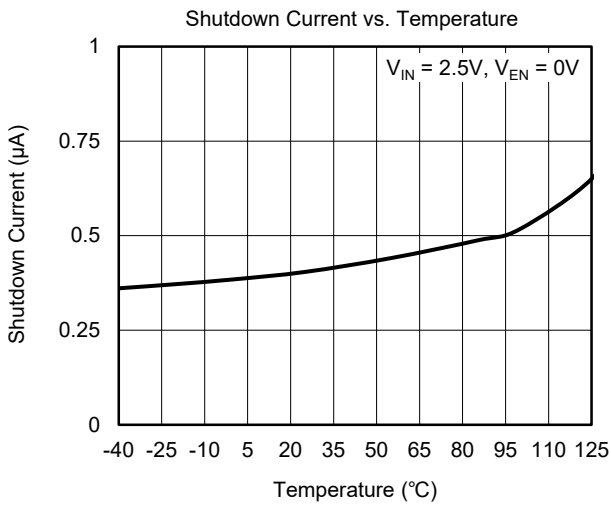
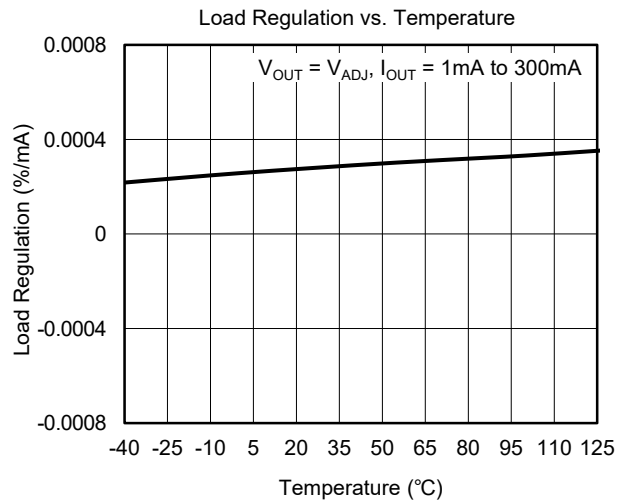
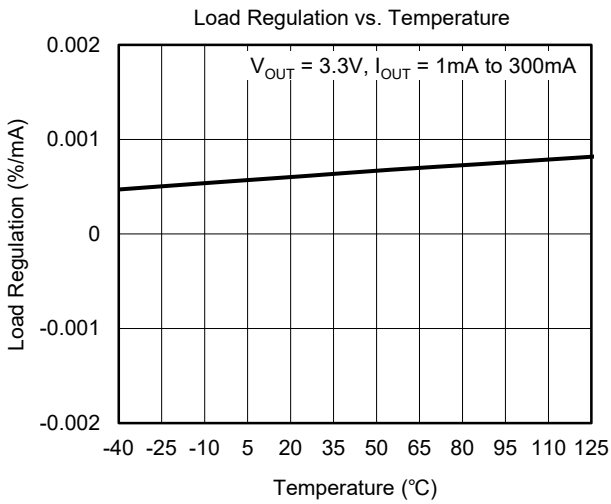
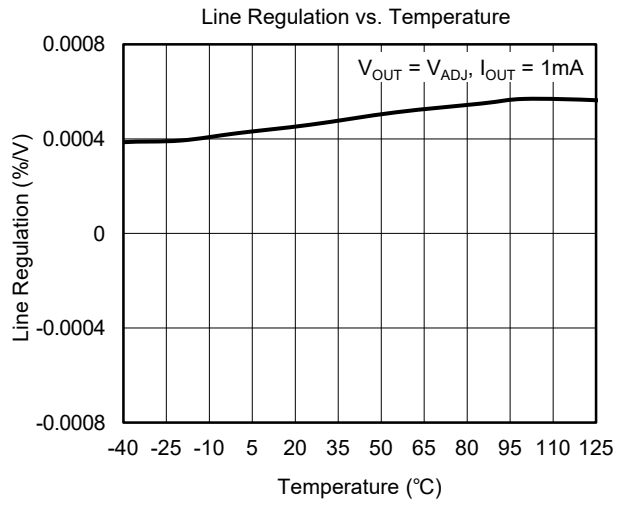
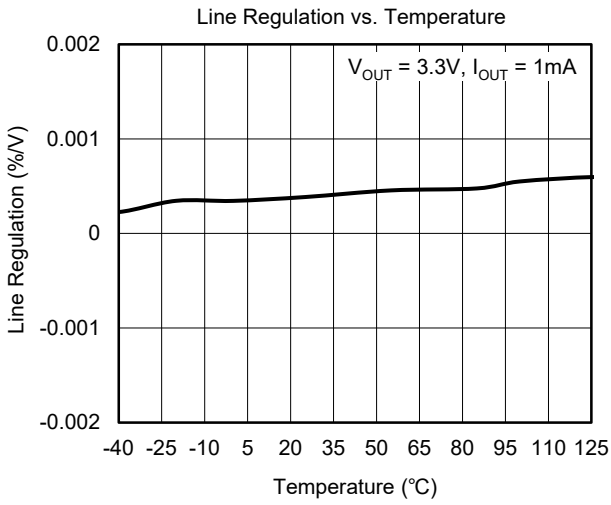

TYPICAL PERFORMANCE CHARACTERISTICS (continued)

$T_J = +25^\circ\text{C}$, $V_{IN} = V_{OUT(NOM)} + 1\text{V}$, $V_{EN} = V_{IN}$, $C_{IN} = C_{OUT} = 2.2\mu\text{F}$, unless otherwise noted.

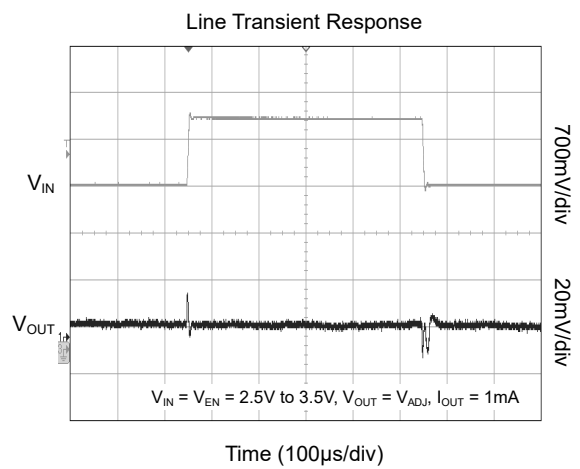
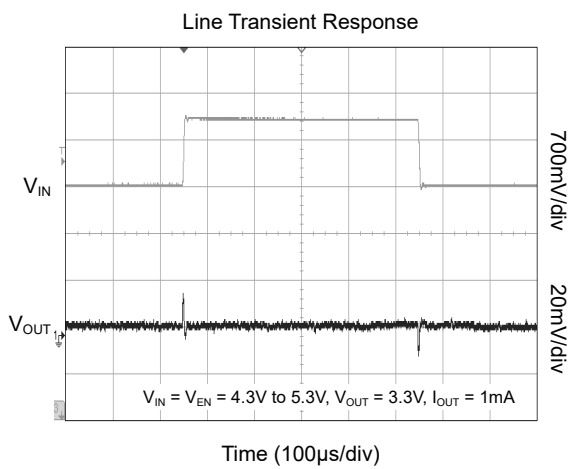
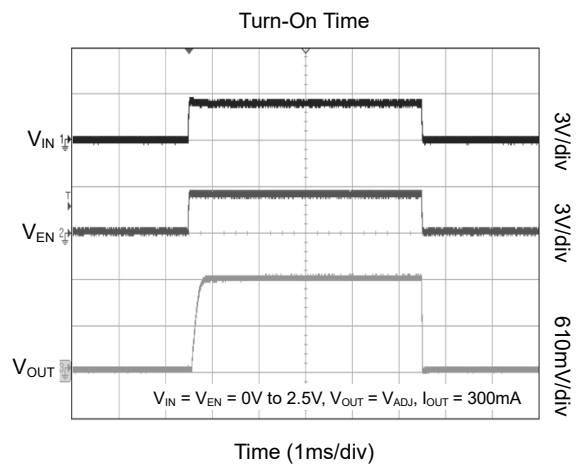
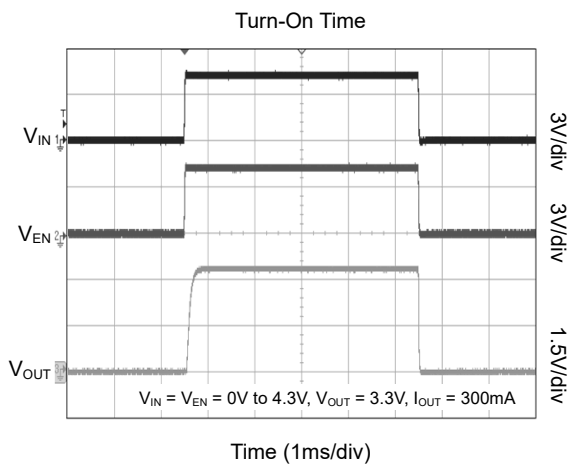
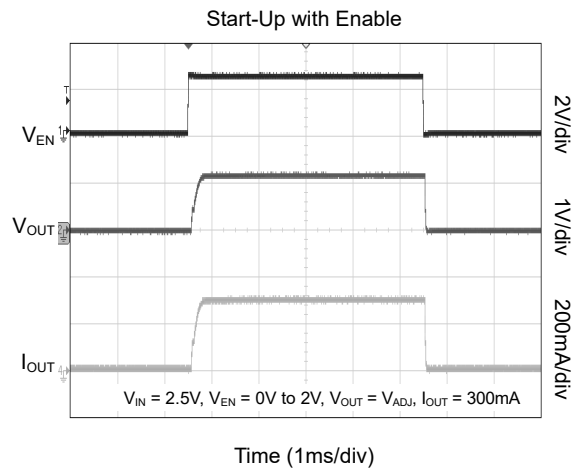
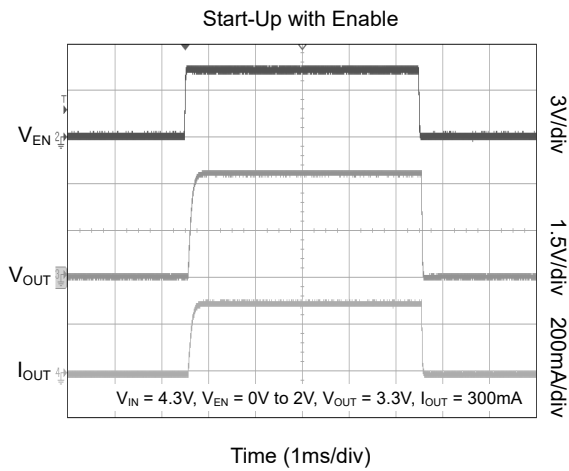

TYPICAL PERFORMANCE CHARACTERISTICS (continued)

$T_J = +25^\circ\text{C}$, $V_{IN} = V_{OUT(NOM)} + 1\text{V}$, $V_{EN} = V_{IN}$, $C_{IN} = C_{OUT} = 2.2\mu\text{F}$, unless otherwise noted.

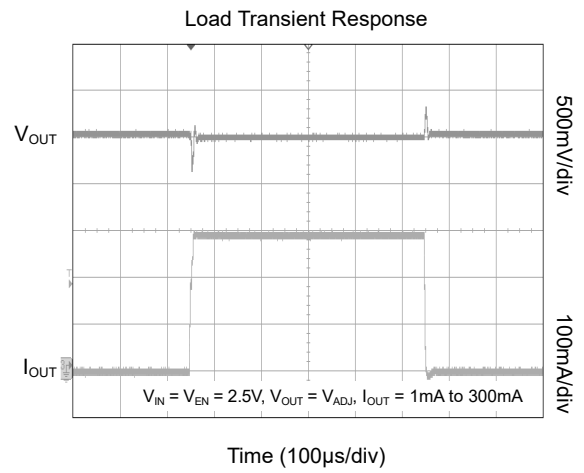
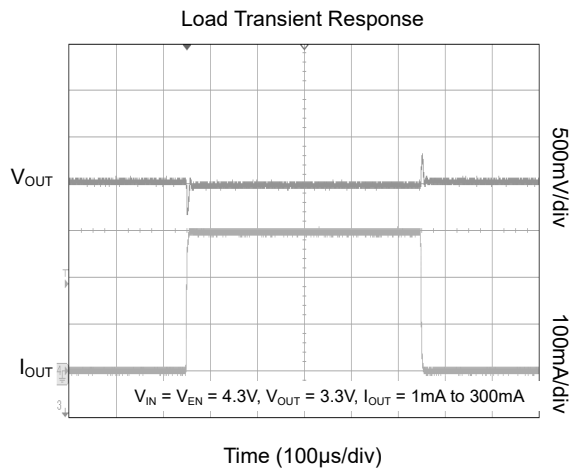

FUNCTIONAL BLOCK DIAGRAM

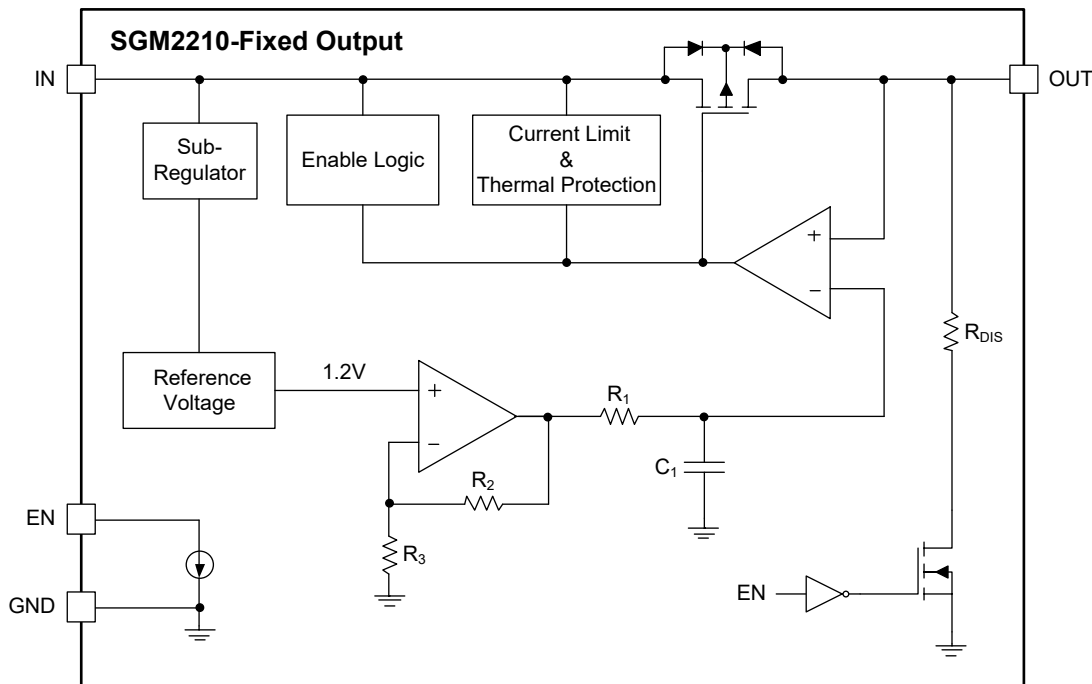

Figure 2. Fixed Version Block Diagram

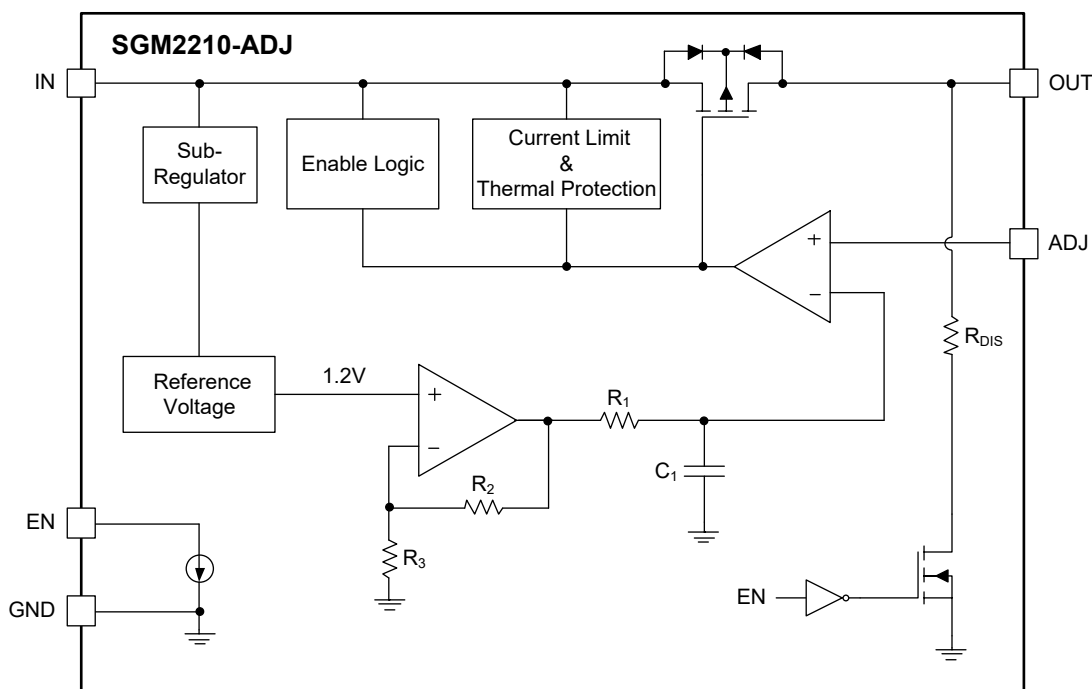

Figure 3. Adjustable Version Block Diagram

APPLICATION INFORMATION

The SGM2210 is a low quiescent current, low noise and low dropout voltage linear regulator and provides 300mA output current. These features make the device a reliable solution to solve many challenging problems in the generation of clean and accurate power supply. The high performance also makes the SGM2210 useful in a variety of applications. The SGM2210 provides protection functions for output overload, output short-circuit condition and overheating.

The SGM2210 provides an EN pin as an external chip enable control to enable/disable the device. When the regulator is in shutdown state, the shutdown current consumes as low as 0.5µA (TYP).

Input Capacitor Selection (C_{IN})

The input decoupling capacitor should be placed as close as possible to the IN pin for ensuring the device stability. 2.2µF or larger X7R or X5R ceramic capacitor is selected to get good dynamic performance.

When V_{IN} is required to provide large current instantaneously, a large effective input capacitor is required. Multiple input capacitors can limit the input tracking inductance. Adding more input capacitors is available to restrict the ringing and to keep it below the device absolute maximum ratings.

Output Capacitor Selection (C_{OUT})

The output decoupling capacitor should be placed as close as possible to the OUT pin. 2.2µF or larger X7R or X5R ceramic capacitor is selected to get good dynamic performance. The minimum effective capacitance of C_{OUT} that SGM2210 can remain stable is 1µF. For ceramic capacitor, temperature, DC bias and package size will change the effective capacitance, so enough margin of C_{OUT} must be considered in design. Additionally, C_{OUT} with larger capacitance and lower ESR will help increase the high frequency PSRR and improve the load transient response.

Adjustable Regulator

The output voltage of the SGM2210-ADJ can be adjusted from 1.2V to 12V. The ADJ pin will be connected to two external resistors as shown in Figure 4. The output voltage is determined by the following equation:

$$V_{OUT} = V_{FB} \times \left(1 + \frac{R_1}{R_2} \right) \tag{1}$$

where:

V_{OUT} is output voltage and V_{FB} is the internal voltage reference, V_{FB} = 1.2V.

One parallel capacitor (C₁) with R₁ can be used to improve the feedback loop stability and PSRR, increase the transient response and reduce the output noise. Use R₂ = 150kΩ to maintain an 8µA minimum load.

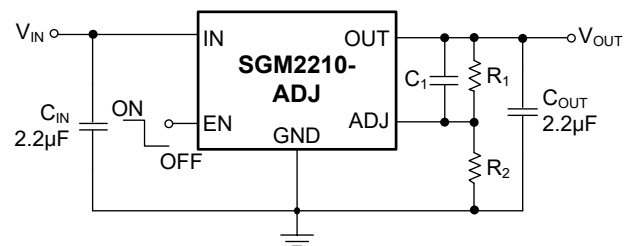

Figure 4. Adjustable Output Voltage Application

Enable Operation

The EN pin of the SGM2210 is used to enable/disable the device and to deactivate/activate the output automatic discharge function.

When the EN pin voltage is lower than 0.4V, the device is in shutdown state. There is no current flowing from IN to OUT pins. In this state, the automatic discharge transistor is active to discharge the output voltage through a 95Ω (TYP) resistor.

When the EN pin voltage is higher than 1.3V, the device is in active state. The output voltage is regulated to expected value and the automatic discharge transistor is turned off.

Reverse Current Protection

The power transistor has an inherent body diode, this body diode will be forward biased when V_{OUT} > V_{IN}. When V_{OUT} > V_{IN}, the reverse current flowing from the OUT pin to the IN pin will damage the SGM2210. If V_{OUT} > (V_{IN} + 0.3V) is expected in the application, one external Schottky diode will be added between the OUT pin and IN pin to protect the SGM2210.

Output Current Limit and Short-Circuit Protection

When overload events happen, the output current is internally limited to 900mA (TYP). When the OUT pin is shorted to ground, the short-circuit protection will limit the output current to 600mA (TYP).

APPLICATION INFORMATION (continued)**Thermal Shutdown**

The SGM2210 can detect the temperature of die. When the die temperature exceeds the threshold value of thermal shutdown, the SGM2210 will be in shutdown state and it will remain in this state until the die temperature decreases to +135°C.

Layout Guidelines

To get good PSRR, low output noise and high transient response performance, the input and output bypass capacitors must be placed as close as possible to the IN pin and OUT pin separately. V_{IN} and V_{OUT} had better use separate ground planes and these ground planes are single point connected to the GND pin.

REVISION HISTORY

NOTE: Page numbers for previous revisions may differ from page numbers in the current version.

| DECEMBER 2021 – REV.A to REV.A.1 | Page |
|---|-------------|
| Updated Electrical Characteristics section | 4, 5 |
| Changes from Original (DECEMBER 2019) to REV.A | Page |
| Changed from product preview to production data | All |

PACKAGE INFORMATION

PACKAGE OUTLINE DIMENSIONS

SOT-23-5

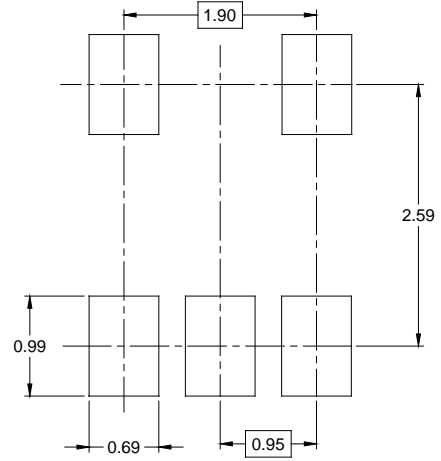
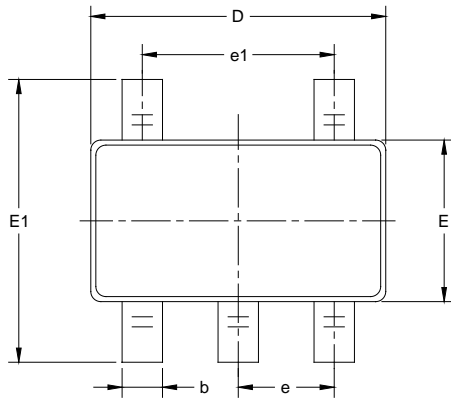

RECOMMENDED LAND PATTERN (Unit: mm)

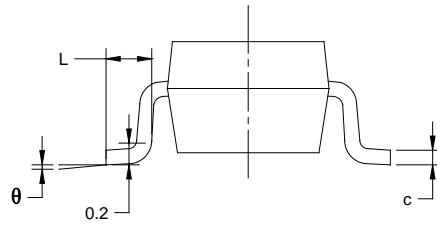
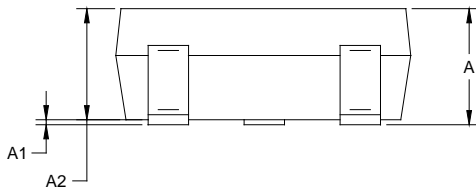

| Symbol | Dimensions In Millimeters | | Dimensions In Inches | |
|----------|------------------------------|-------|-------------------------|-------|
| | MIN | MAX | MIN | MAX |
| A | 1.050 | 1.250 | 0.041 | 0.049 |
| A1 | 0.000 | 0.100 | 0.000 | 0.004 |
| A2 | 1.050 | 1.150 | 0.041 | 0.045 |
| b | 0.300 | 0.500 | 0.012 | 0.020 |
| c | 0.100 | 0.200 | 0.004 | 0.008 |
| D | 2.820 | 3.020 | 0.111 | 0.119 |
| E | 1.500 | 1.700 | 0.059 | 0.067 |
| E1 | 2.650 | 2.950 | 0.104 | 0.116 |
| e | 0.950 BSC | | 0.037 BSC | |
| e1 | 1.900 BSC | | 0.075 BSC | |
| L | 0.300 | 0.600 | 0.012 | 0.024 |
| θ | 0° | 8° | 0° | 8° |

NOTES:

1. Body dimensions do not include mode flash or protrusion.
2. This drawing is subject to change without notice.

PACKAGE INFORMATION

TAPE AND REEL INFORMATION

REEL DIMENSIONS



TAPE DIMENSIONS



NOTE: The picture is only for reference. Please make the object as the standard.

KEY PARAMETER LIST OF TAPE AND REEL

| Package Type | Reel Diameter | Reel Width W1 (mm) | A0 (mm) | B0 (mm) | K0 (mm) | P0 (mm) | P1 (mm) | P2 (mm) | W (mm) | Pin1 Quadrant |
|--------------|---------------|--------------------|---------|---------|---------|---------|---------|---------|--------|---------------|
| SOT-23-5 | 7" | 9.5 | 3.20 | 3.20 | 1.40 | 4.0 | 4.0 | 2.0 | 8.0 | Q3 |

DD0001

PACKAGE INFORMATION

CARTON BOX DIMENSIONS



NOTE: The picture is only for reference. Please make the object as the standard.

KEY PARAMETER LIST OF CARTON BOX

| Reel Type | Length (mm) | Width (mm) | Height (mm) | Pizza/Carton |
|-------------|-------------|------------|-------------|--------------|
| 7" (Option) | 368 | 227 | 224 | 8 |
| 7" | 442 | 410 | 224 | 18 |

DD0002