

SGM8965A-1/SGM8965A-2

50MHz, Low Distortion, RRIO, Single-Supply Operational Amplifiers

GENERAL DESCRIPTION

The SGM8965A-1/2 are zero-crossover, rail-to-rail input and output, high-performance, CMOS operational amplifiers which are optimized for low voltage, single-supply applications. Rail-to-rail input and output, low noise and high speed operation make these devices ideal for driving sampling analog-to-digital converters (ADCs). Applications include audio, signal conditioning and sensor amplification. The SGM8965A-1/2 operational amplifiers are also well-suited for cell phone power amplifier control loops.

Special features include no input stage crossover distortion, high input impedance, and rail-to-rail input and output swing. The input common mode voltage range includes both the negative and positive supplies. The output voltage swing is within 6mV (TYP) of the rails.

The single SGM8965A-1 is available in Green SOT-23-5 and SOIC-8 packages. The dual SGM8965A-2 is available in Green SOIC-8 and MSOP-8 packages. They are specified for operation from -40°C to +125°C.

FEATURES

- **Gain Bandwidth: 50MHz**
- **High CMRR: 94dB (TYP)**
- **Rail-to-Rail Input and Output**
- **Low Noise: 5.5nV/√Hz at 100kHz**
- **Slew Rate: 30V/μs**
- **High Precision:**
 - **Low Offset: 50μV (TYP), 280μV (MAX)**
 - **Low Input Bias Current: 1pA (TYP)**
- **Unity-Gain Stable**
- **2.2V to 5.5V Operation Voltage Range**
- **-40°C to +125°C Operating Temperature Range**
- **Small Packaging:**
 - **SGM8965A-1 Available in Green SOT-23-5 and SOIC-8 Packages**
 - **SGM8965A-2 Available in Green SOIC-8 and MSOP-8 Packages**

APPLICATIONS

Signal Conditioning
Data Acquisition
Process Control
Active Filter
Test Equipment
Audio
Wideband Amplifier

PACKAGE/ORDERING INFORMATION

MODEL	PACKAGE DESCRIPTION	SPECIFIED TEMPERATURE RANGE	ORDERING NUMBER	PACKAGE MARKING	PACKING OPTION
SGM8965A-1	SOT-23-5	-40°C to +125°C	SGM8965A-1XN5G/TR	MLEXX	Tape and Reel, 3000
	SOIC-8	-40°C to +125°C	SGM8965A-1XS8G/TR	SGM MLCXS8 XXXXX	Tape and Reel, 4000
SGM8965A-2	SOIC-8	-40°C to +125°C	SGM8965A-2XS8G/TR	SGM MLBXS8 XXXXX	Tape and Reel, 4000
	MSOP-8	-40°C to +125°C	SGM8965A-2XMS8G/TR	SGMMLD XMS8 XXXXX	Tape and Reel, 4000

MARKING INFORMATION

NOTE: XX = Date Code. XXXXX = Date Code, Trace Code and Vendor Code.

SOT-23-5

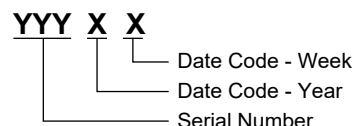

SOIC-8/MSOP-8

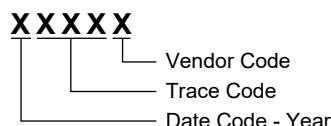

Green (RoHS & HSF): SG Micro Corp defines "Green" to mean Pb-Free (RoHS compatible) and free of halogen substances. If you have additional comments or questions, please contact your SGMICRO representative directly.

ABSOLUTE MAXIMUM RATINGS

- Supply Voltage..... 6V
- Input Voltage Range..... (-V_S) - 0.3V to (+V_S) + 0.3V
- Input Current (All pins except power supply pins)..... ±10mA
- Output Short-Circuit..... Continuous
- Junction Temperature..... +150°C
- Storage Temperature Range..... -65°C to +150°C
- Lead Temperature (Soldering, 10s)..... +260°C
- ESD Susceptibility
- HBM (SGM8265A-1)..... 5000V
- HBM (SGM8265A-2)..... 7000V
- CDM..... 2000V

RECOMMENDED OPERATING CONDITIONS

- Supply Voltage Range..... 2.2V to 5.5V
- Operating Temperature Range..... -40°C to +125°C

OVERSTRESS CAUTION

Stresses beyond those listed in Absolute Maximum Ratings may cause permanent damage to the device. Exposure to absolute maximum rating conditions for extended periods may affect reliability. Functional operation of the device at any conditions beyond those indicated in the Recommended Operating Conditions section is not implied.

ESD SENSITIVITY CAUTION

This integrated circuit can be damaged by ESD if you don't pay attention to ESD protection. SGMICRO recommends that all integrated circuits be handled with appropriate precautions. Failure to observe proper handling and installation procedures can cause damage. ESD damage can range from subtle performance degradation to complete device failure. Precision integrated circuits may be more susceptible to damage because very small parametric changes could cause the device not to meet its published specifications.

DISCLAIMER

SG Micro Corp reserves the right to make any change in circuit design, or specifications without prior notice.

PIN CONFIGURATIONS

SGM8965A-1 (TOP VIEW)

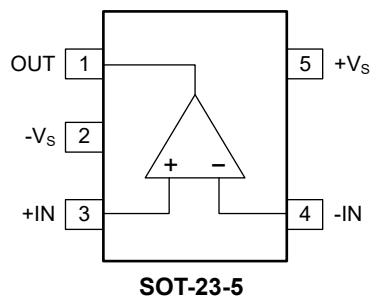

SGM8965A-1 (TOP VIEW)

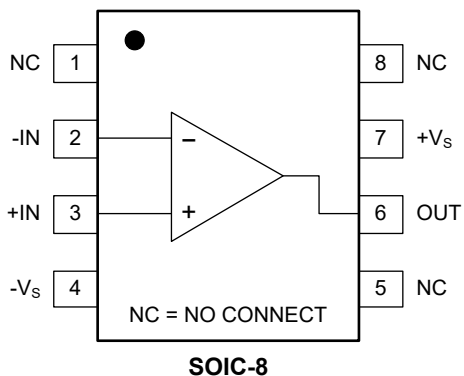

SGM8965A-2 (TOP VIEW)

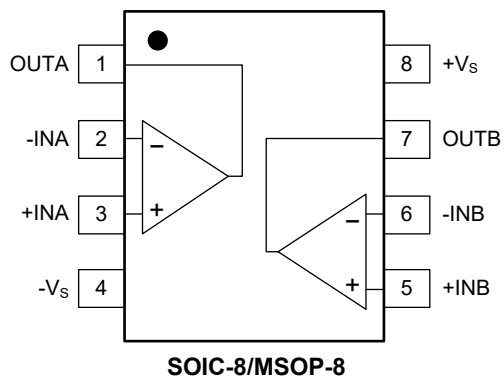

ELECTRICAL CHARACTERISTICS

(At $T_A = +25^\circ\text{C}$, $V_S = 2.2\text{V}$ to 5.5V , $V_{CM} = V_S/2$, $V_{OUT} = V_S/2$ and $R_L = 10\text{k}\Omega$ connected to $V_S/2$, Full = -40°C to $+125^\circ\text{C}$, unless otherwise noted.)

PARAMETER	CONDITIONS	TEMP	MIN	TYP	MAX	UNITS
Input Characteristics						
Input Offset Voltage (V_{OS})		$+25^\circ\text{C}$		50	280	μV
Input Offset Voltage Drift ($\Delta V_{OS}/\Delta T$)		Full		1.4		$\mu\text{V}/^\circ\text{C}$
Input Bias Current (I_B)		Full		1	2800	pA
Input Offset Current (I_{OS})		Full		1	180	pA
Input Common Mode Voltage Range (V_{CM})		Full	$(-V_S) - 0.1$		$(+V_S) + 0.1$	V
Common Mode Rejection Ratio (CMRR)	$(-V_S) - 0.1\text{V} \leq V_{CM} \leq (+V_S) + 0.1\text{V}$	$+25^\circ\text{C}$	77	94		dB
		Full	68			
Open-Loop Voltage Gain (A_{OL})	$R_L = 600\Omega$, $200\text{mV} < V_{OUT} < (+V_S) - 200\text{mV}$	$+25^\circ\text{C}$	91	118		dB
		Full	88			
	$R_L = 10\text{k}\Omega$, $100\text{mV} < V_{OUT} < (+V_S) - 100\text{mV}$	$+25^\circ\text{C}$	92	118		
		Full	89			
Output Characteristics						
Output Voltage Swing from Rail	$R_L = 10\text{k}\Omega$, $V_S = 5.5\text{V}$	Full		6	12	mV
Output Short-Circuit Current (I_{SC})	$V_S = 5.5\text{V}$	$+25^\circ\text{C}$		85		mA
Open-Loop Output Impedance	$f = 1\text{MHz}$, $I_{OUT} = 0$	$+25^\circ\text{C}$		30		Ω
Power Supply						
Specified Voltage Range (V_S)		Full	2.2		5.5	V
Quiescent Current/Amplifier (I_Q)	$I_{OUT} = 0\text{A}$	$+25^\circ\text{C}$		5	6.5	mA
		Full			6.7	
Power Supply Rejection Ratio (PSRR)		Full		4	70	$\mu\text{V}/\text{V}$
Dynamic Performance						
Gain-Bandwidth Product (GBP)	$R_L = 10\text{k}\Omega$, $C_L = 10\text{pF}$	$+25^\circ\text{C}$		50		MHz
Phase Margin (ϕ_o)	$R_L = 10\text{k}\Omega$, $C_L = 10\text{pF}$	$+25^\circ\text{C}$		55		$^\circ$
Slew Rate (SR)	$G = +1$	$+25^\circ\text{C}$		30		$\text{V}/\mu\text{s}$
Settling Time to 0.1%	4V step, $G = -1$	$+25^\circ\text{C}$		380		ns
Settling Time to 0.01%	4V step, $G = -1$	$+25^\circ\text{C}$		650		ns
Overload Recovery Time	$V_{IN} \times G > V_S$	$+25^\circ\text{C}$		< 0.1		μs
Total Harmonic Distortion + Noise (THD+N)	$R_L = 600\Omega$, $V_{OUT} = 4V_{P-P}$, $G = +1$, $f = 1\text{kHz}$	$+25^\circ\text{C}$		0.00018		%
Noise						
Input Voltage Noise	$f = 0.1\text{Hz}$ to 10Hz	$+25^\circ\text{C}$		9		μV_{P-P}
Input Voltage Noise Density (e_n)	$f = 100\text{kHz}$	$+25^\circ\text{C}$		5.5		$\text{nV}/\sqrt{\text{Hz}}$
Input Current Noise Density (i_n)	$f = 10\text{kHz}$	$+25^\circ\text{C}$		20		$\text{fA}/\sqrt{\text{Hz}}$

TYPICAL PERFORMANCE CHARACTERISTICS

At $T_A = +25^\circ\text{C}$, $V_S = 5\text{V}$, $R_L = 10\text{k}\Omega$ and $C_L = 10\text{pF}$, unless otherwise noted.

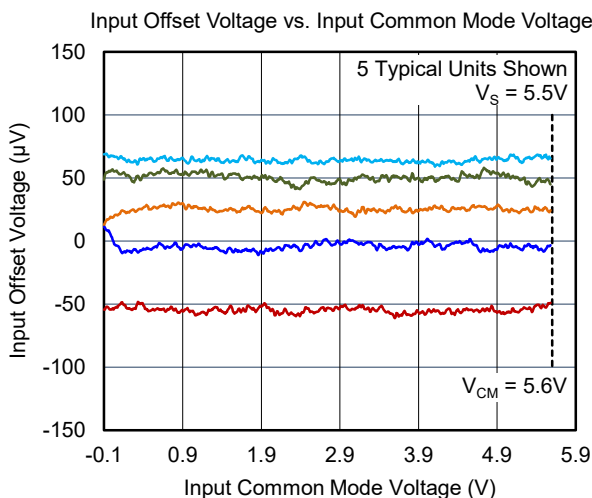
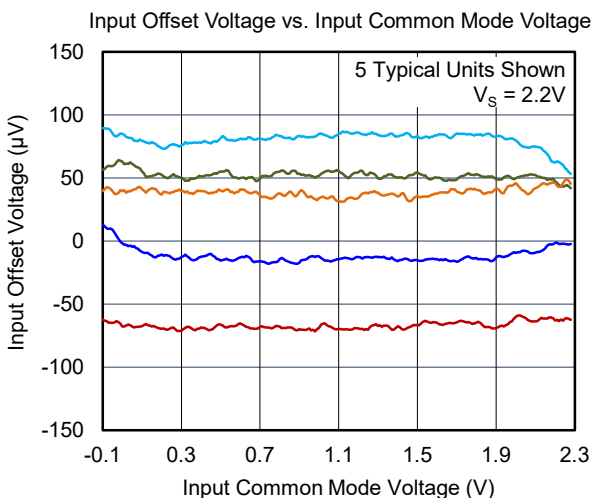
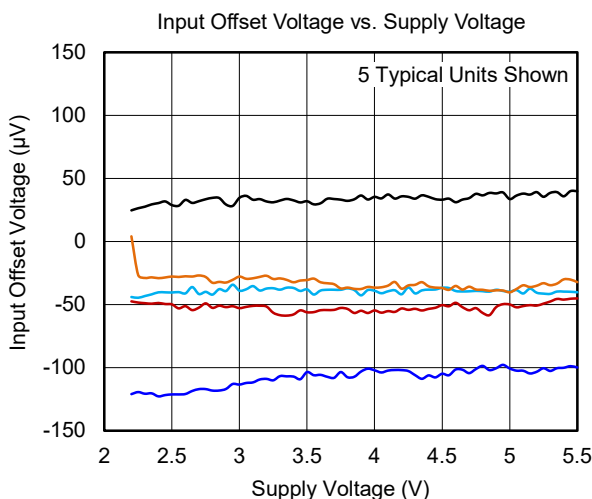
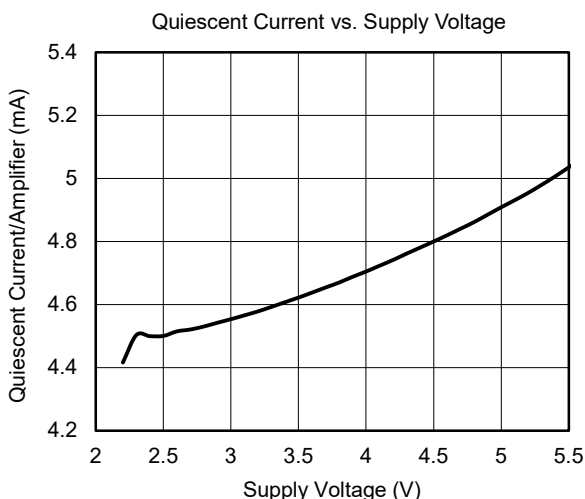
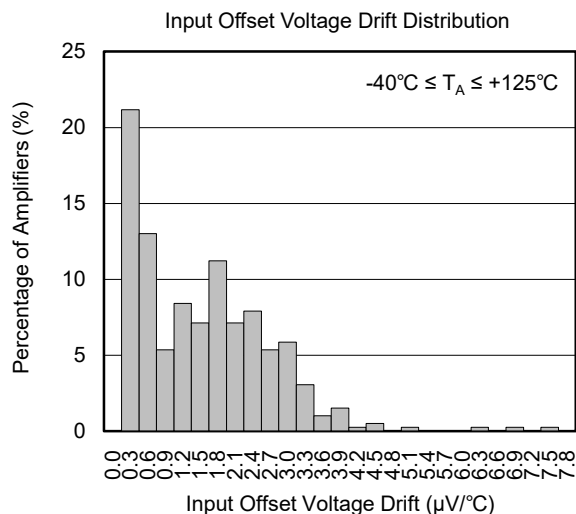
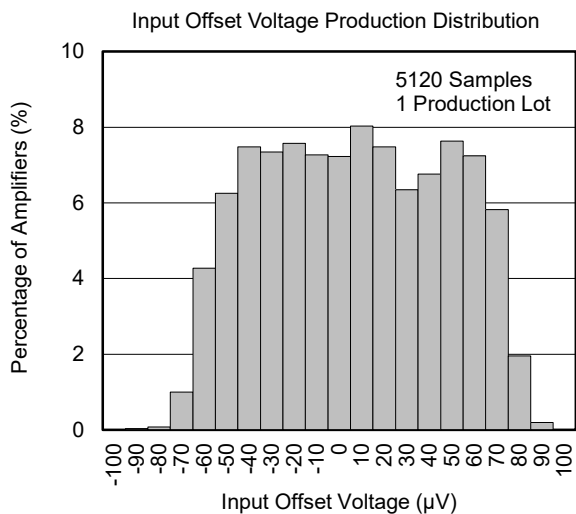

TYPICAL PERFORMANCE CHARACTERISTICS (continued)

At $T_A = +25^\circ\text{C}$, $V_S = 5\text{V}$, $R_L = 10\text{k}\Omega$ and $C_L = 10\text{pF}$, unless otherwise noted.

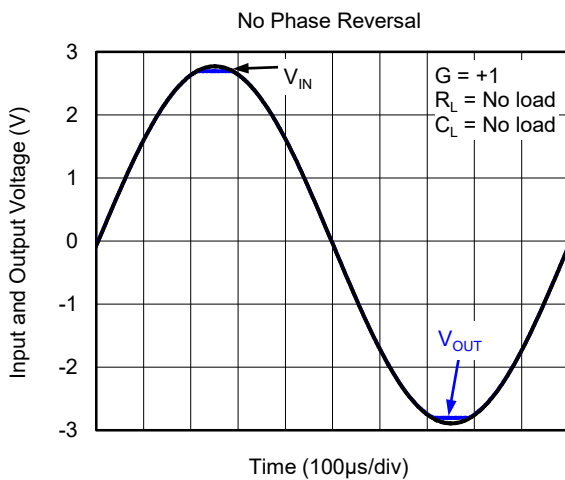
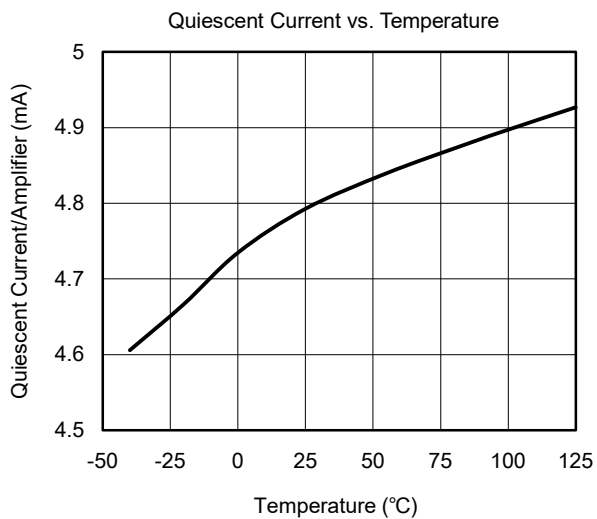
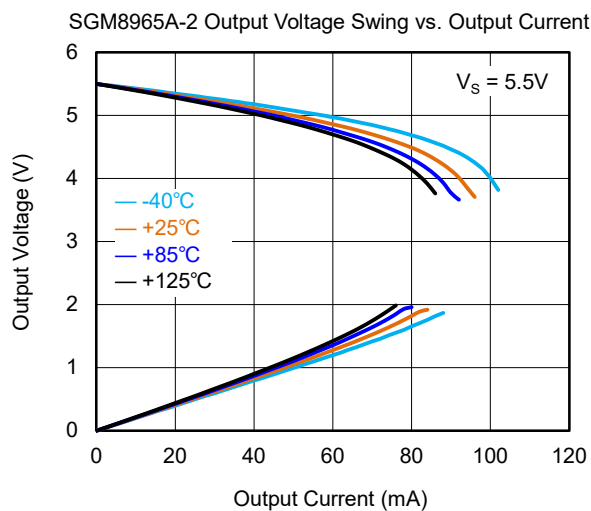
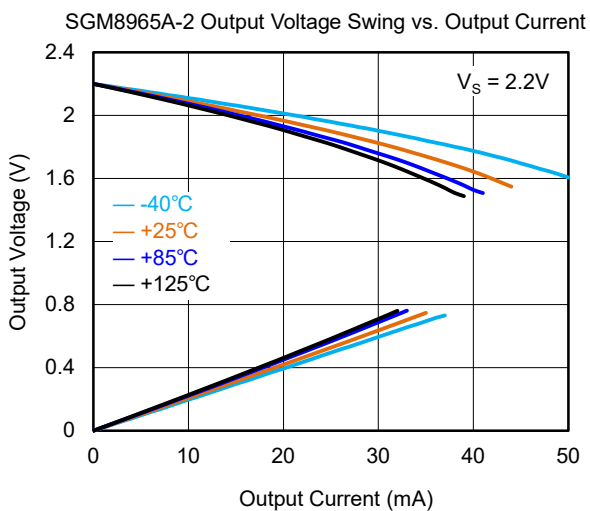
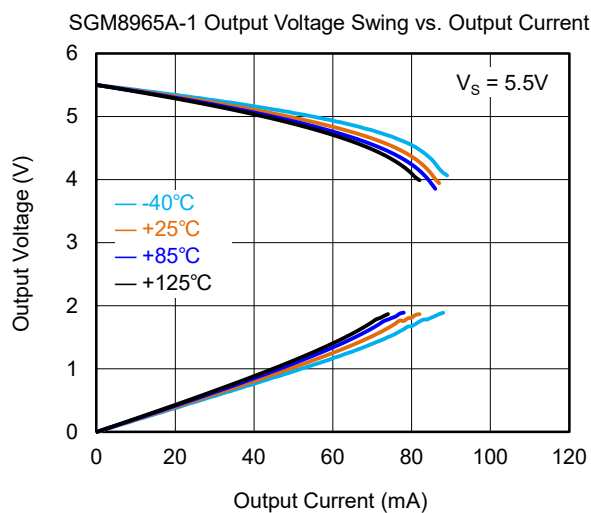
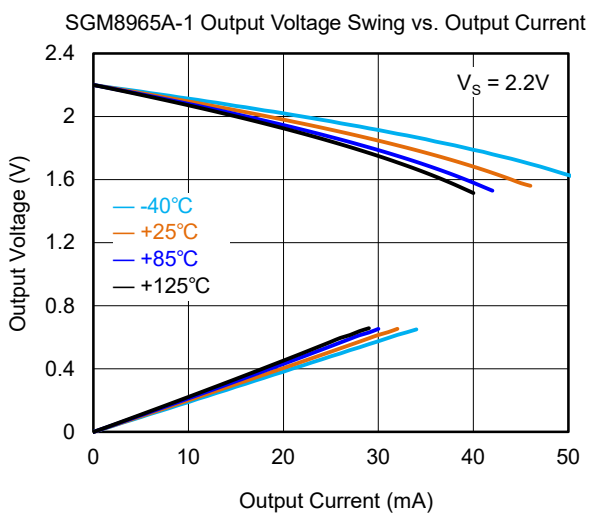

TYPICAL PERFORMANCE CHARACTERISTICS (continued)

At $T_A = +25^\circ\text{C}$, $V_S = 5\text{V}$, $R_L = 10\text{k}\Omega$ and $C_L = 10\text{pF}$, unless otherwise noted.

Small-Signal Step Response

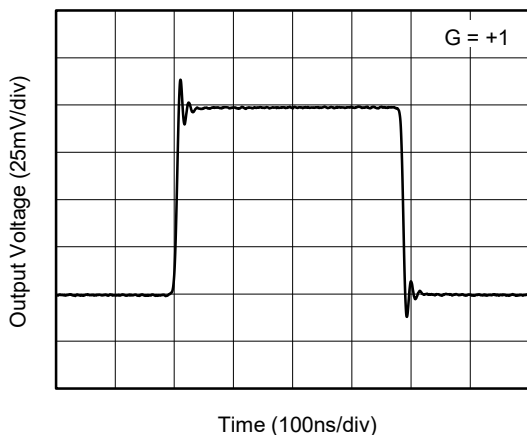

Large-Signal Step Response

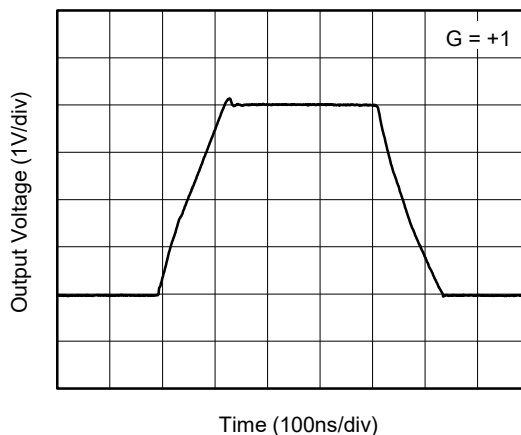

Positive Overload Recovery

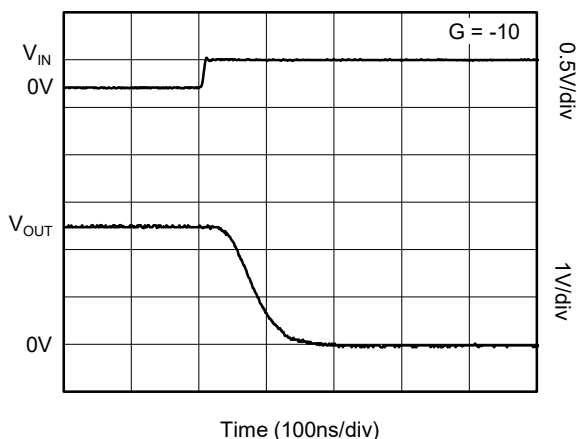

Negative Overload Recovery

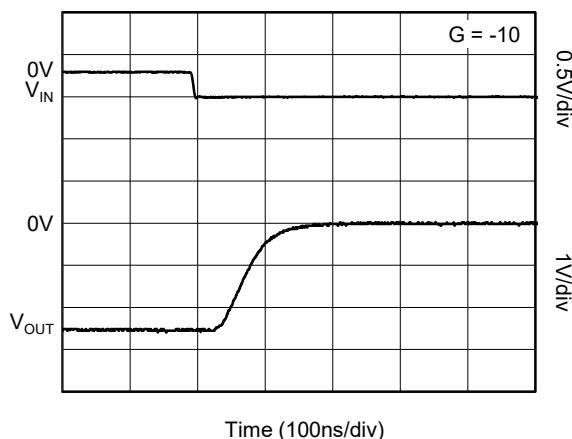

0.1Hz to 10Hz Input Voltage Noise

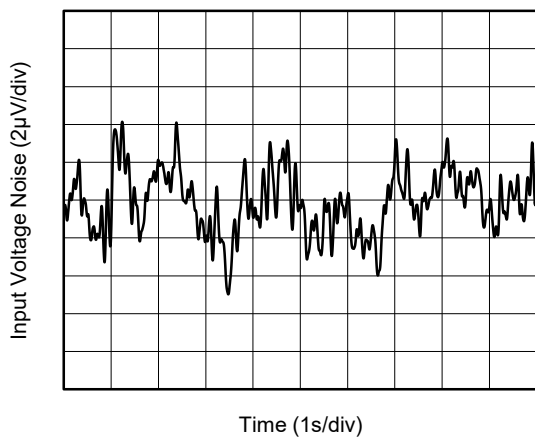

Input Voltage Noise Density vs. Frequency

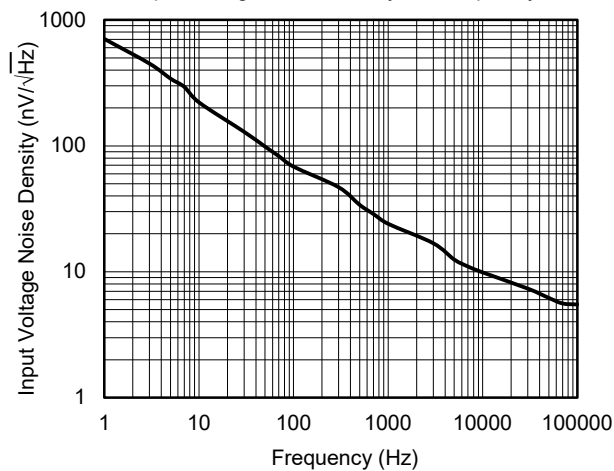

TYPICAL PERFORMANCE CHARACTERISTICS (continued)

At $T_A = +25^\circ\text{C}$, $V_S = 5\text{V}$, $R_L = 10\text{k}\Omega$ and $C_L = 10\text{pF}$, unless otherwise noted.

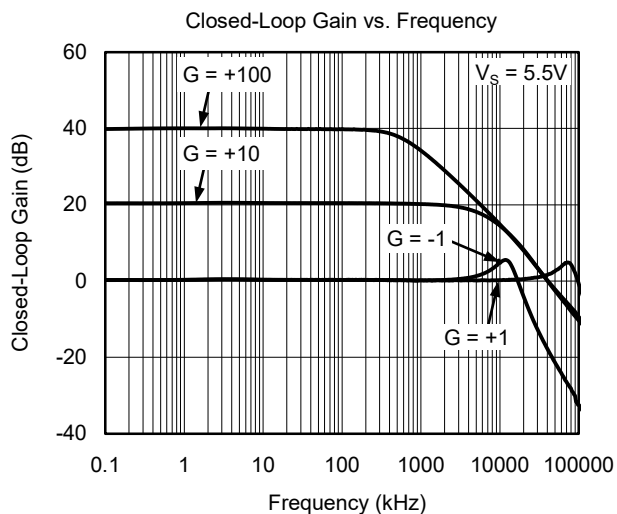
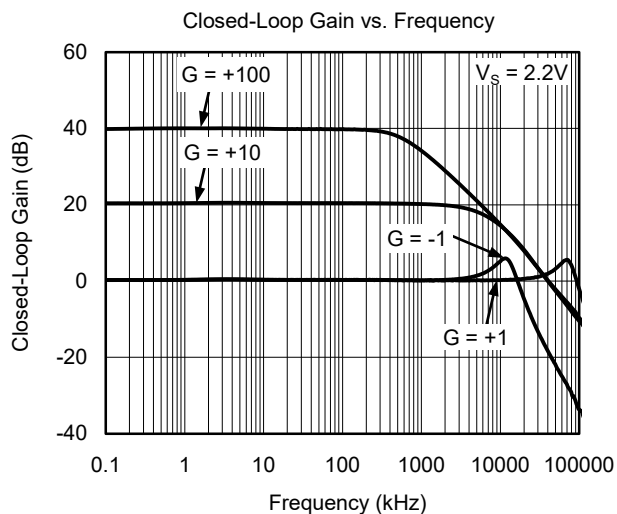
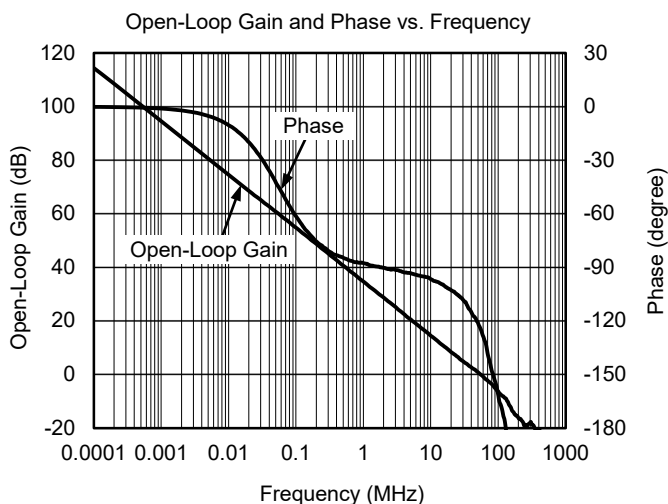
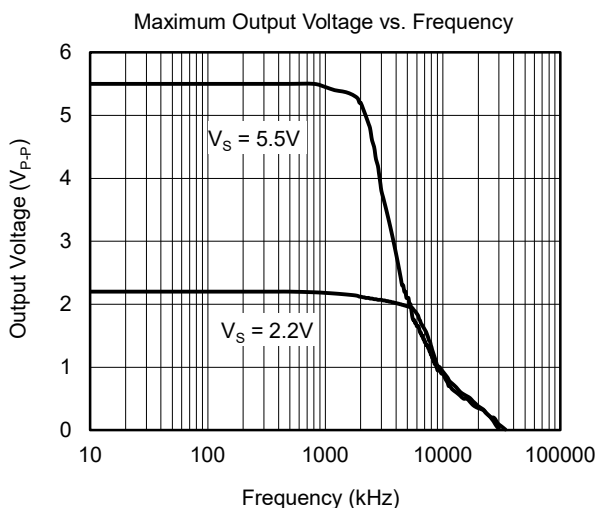
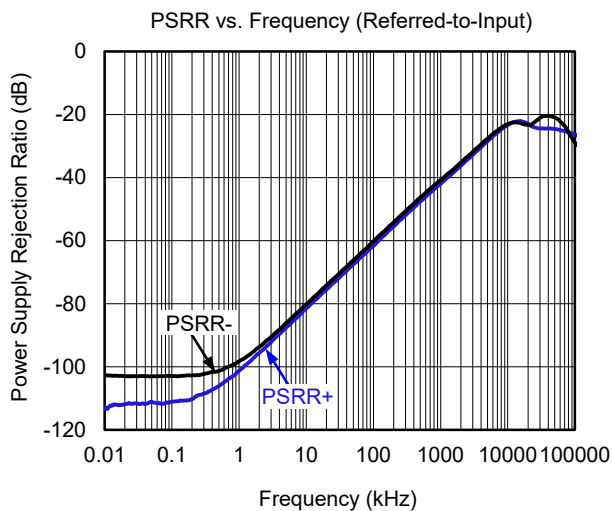
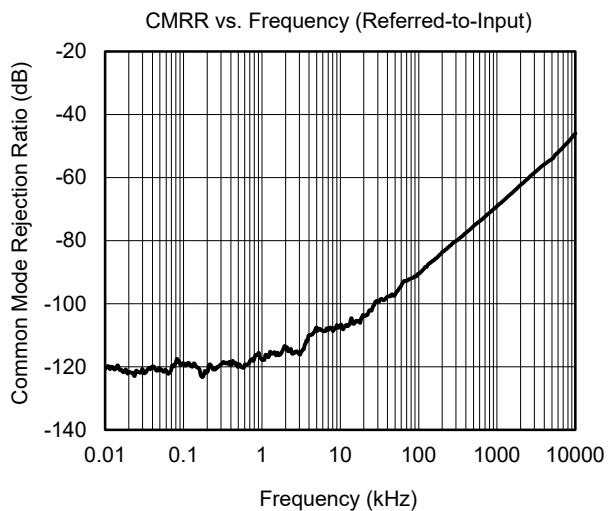

TYPICAL PERFORMANCE CHARACTERISTICS (continued)

At $T_A = +25^\circ\text{C}$, $V_S = 5\text{V}$, $R_L = 10\text{k}\Omega$ and $C_L = 10\text{pF}$, unless otherwise noted.

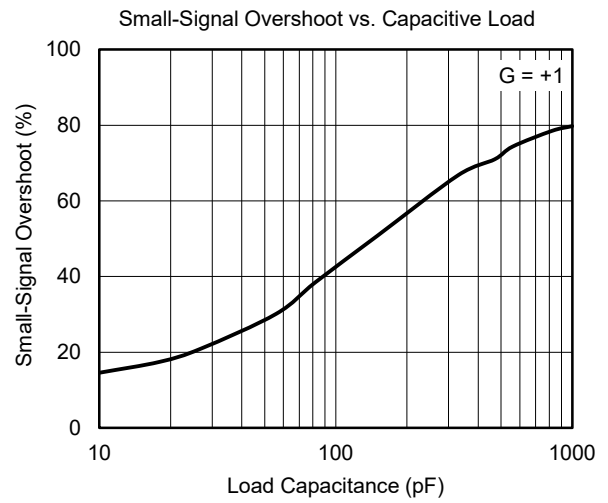
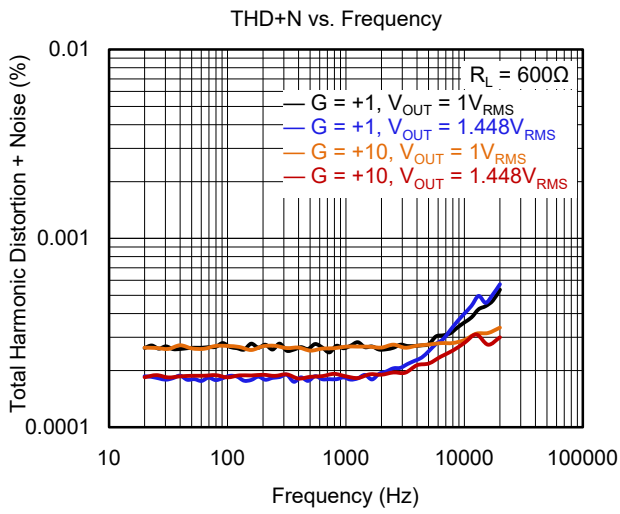

APPLICATION INFORMATION

Basic Amplifier Configurations

As with other single-supply operational amplifiers, the SGM8965A-1/2 may be operated with either a single supply or dual supplies. A typical dual-supply connection is shown in Figure 1, which is accompanied by a single-supply connection. The SGM8965A-1 is configured as a basic inverting amplifier with a gain of $-10V/V$. The dual-supply connection has an output voltage centered on zero, while the single-supply

connection has an output centered on the common mode voltage V_{CM} . For the circuit shown, this voltage is 1.5V, but may be any value within the input common mode voltage range. The SGM8965A-1 V_{CM} range extends 100mV beyond the power supply rails.

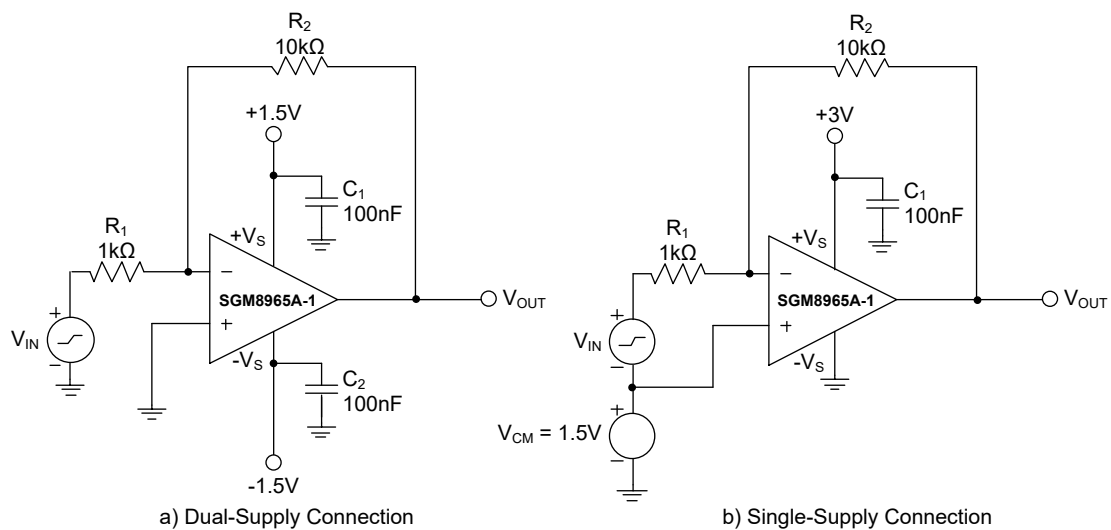
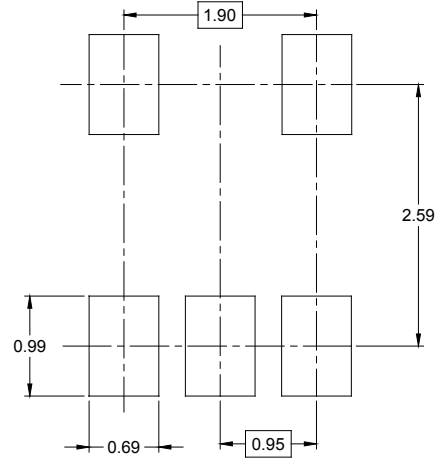
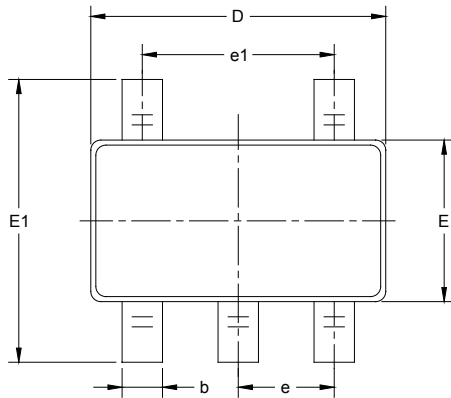

Figure 1. Basic Circuit Connections

PACKAGE INFORMATION

PACKAGE OUTLINE DIMENSIONS

SOT-23-5



RECOMMENDED LAND PATTERN (Unit: mm)

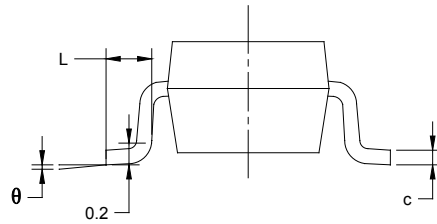

Symbol	Dimensions In Millimeters		Dimensions In Inches	
	MIN	MAX	MIN	MAX
A	1.050	1.250	0.041	0.049
A1	0.000	0.100	0.000	0.004
A2	1.050	1.150	0.041	0.045
b	0.300	0.500	0.012	0.020
c	0.100	0.200	0.004	0.008
D	2.820	3.020	0.111	0.119
E	1.500	1.700	0.059	0.067
E1	2.650	2.950	0.104	0.116
e	0.950 BSC		0.037 BSC	
e1	1.900 BSC		0.075 BSC	
L	0.300	0.600	0.012	0.024
θ	0°	8°	0°	8°

PACKAGE INFORMATION

PACKAGE OUTLINE DIMENSIONS

SOIC-8

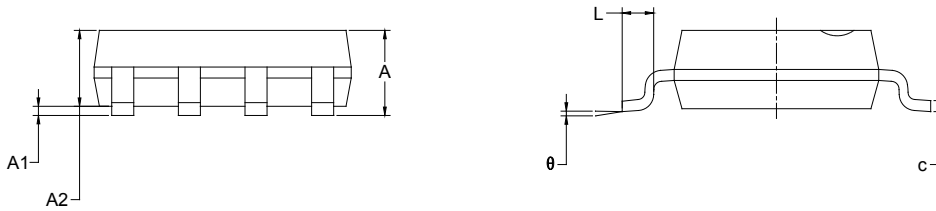
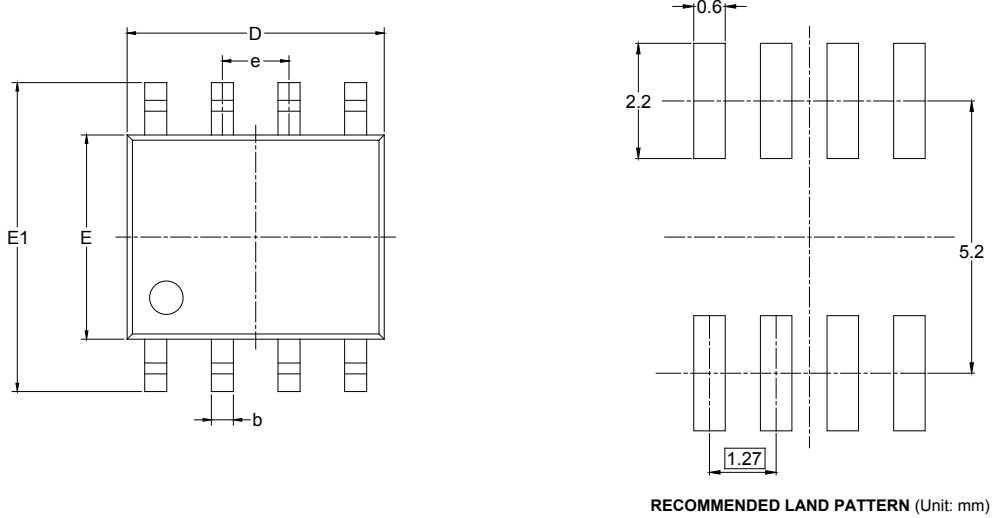

Symbol	Dimensions In Millimeters		Dimensions In Inches	
	MIN	MAX	MIN	MAX
A	1.350	1.750	0.053	0.069
A1	0.100	0.250	0.004	0.010
A2	1.350	1.550	0.053	0.061
b	0.330	0.510	0.013	0.020
c	0.170	0.250	0.006	0.010
D	4.700	5.100	0.185	0.200
E	3.800	4.000	0.150	0.157
E1	5.800	6.200	0.228	0.244
e	1.27 BSC		0.050 BSC	
L	0.400	1.270	0.016	0.050
θ	0°	8°	0°	8°

PACKAGE OUTLINE DIMENSIONS

MSOP-8



RECOMMENDED LAND PATTERN (Unit: mm)

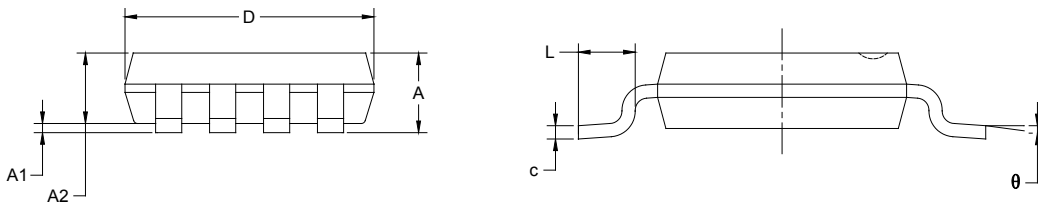

Symbol	Dimensions In Millimeters		Dimensions In Inches	
	MIN	MAX	MIN	MAX
A	0.820	1.100	0.032	0.043
A1	0.020	0.150	0.001	0.006
A2	0.750	0.950	0.030	0.037
b	0.250	0.380	0.010	0.015
c	0.090	0.230	0.004	0.009
D	2.900	3.100	0.114	0.122
E	2.900	3.100	0.114	0.122
E1	4.750	5.050	0.187	0.199
e	0.650 BSC		0.026 BSC	
L	0.400	0.800	0.016	0.031
θ	0°	6°	0°	6°

PACKAGE INFORMATION

TAPE AND REEL INFORMATION

REEL DIMENSIONS

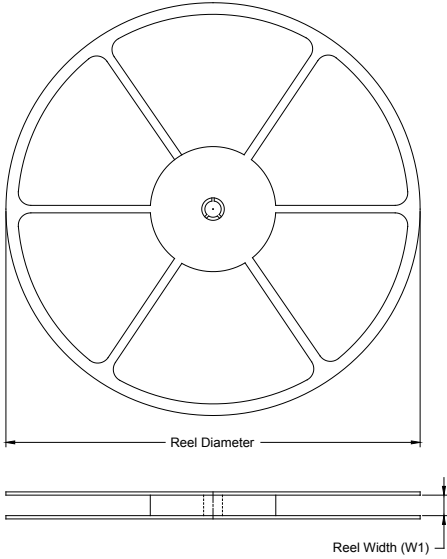

TAPE DIMENSIONS

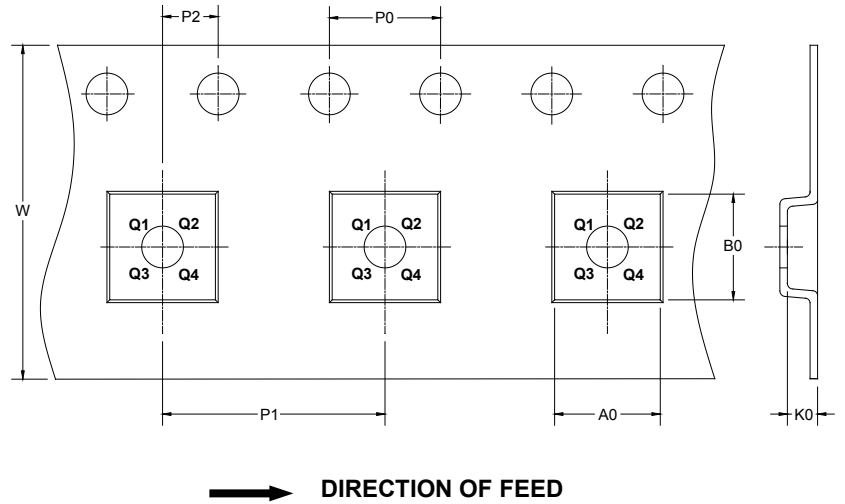

NOTE: The picture is only for reference. Please make the object as the standard.

KEY PARAMETER LIST OF TAPE AND REEL

Package Type	Reel Diameter	Reel Width W1 (mm)	A0 (mm)	B0 (mm)	K0 (mm)	P0 (mm)	P1 (mm)	P2 (mm)	W (mm)	Pin1 Quadrant
SOT-23-5	7"	9.5	3.20	3.20	1.40	4.0	4.0	2.0	8.0	Q3
SOIC-8	13"	12.4	6.40	5.40	2.10	4.0	8.0	2.0	12.0	Q1
MSOP-8	13"	12.4	5.20	3.30	1.50	4.0	8.0	2.0	12.0	Q1

DD0001

PACKAGE INFORMATION

CARTON BOX DIMENSIONS



NOTE: The picture is only for reference. Please make the object as the standard.

KEY PARAMETER LIST OF CARTON BOX

Reel Type	Length (mm)	Width (mm)	Height (mm)	Pizza/Carton
7" (Option)	368	227	224	8
7"	442	410	224	18
13"	386	280	370	5

DD0002