

SGM2588

Power Distribution Switch

GENERAL DESCRIPTION

The SGM2588 is an integrated 100mΩ (TYP) power switch for self-powered and bus-powered Universal Series Bus (USB) applications.

The SGM2588 is internally current limited and has thermal shutdown that protects device and load from over-current damage. Thermal shutdown shuts off the output MOSFET and asserts the $\overline{\text{FAULT}}$ output if the die temperature exceeds 150°C until the die temperature drops to 130°C.

This device employs soft-start circuit that minimizes inrush current in applications where highly capacitive loads are employed.

An open drain $\overline{\text{FAULT}}$ flag asserts low during over-current and thermal conditions after a 13ms blanking time to prevent false reporting.

SGM2588 is available in the Green SOT-23-5 package. It is rated over the -40°C to +85°C temperature range.

FEATURES

- 100mΩ (TYP) High-side N-Channel MOSFET
- Three Current Limit Levels
 - SGM2588A/B/G: 1100 ± 100mA
 - SGM2588C/D/I: 2100 ± 210mA
 - SGM2588E/F/K: 2600 ± 300mA
- Input Voltage Range: 2.5V to 5.5V
- Low 23μA Quiescent Current
- Typical 0.1μA Shutdown Current
- Soft-Start Function
- Thermal Shutdown Protection
- Under-Voltage Lockout Protection for VIN
- No Reversed Leakage Current (Reverse Blocking)
- Fault Flag ($\overline{\text{FAULT}}$) with 13ms Filter Eliminates False Assertions
- Automatic Output Discharge in Shutdown Mode (SGM2588A/B/C/D/E/F)
- 500kΩ Pull-Down Resistor at EN Pin (SGM2588G/I/K)
- Available in the Green SOT-23-5 Package

APPLICATIONS

General Purpose Power Switching
USB Bus/Self Powered Hubs/Peripherals
ACPI Power Distribution
Smart Phone & LCD TV

TYPICAL APPLICATION

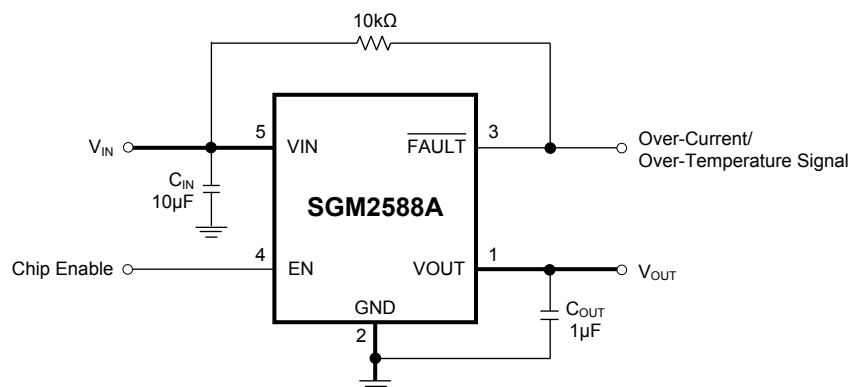

Figure 1. Typical Application Circuit

PACKAGE/ORDERING INFORMATION

MODEL	PACKAGE DESCRIPTION	SPECIFIED TEMPERATURE RANGE	ORDERING NUMBER	PACKAGE MARKING	PACKING OPTION
SGM2588A (Active High)	SOT-23-5	-40°C to +85°C	SGM2588AYN5G/TR	SSCXX	Tape and Reel, 3000
SGM2588B (Active Low)	SOT-23-5	-40°C to +85°C	SGM2588BYN5G/TR	SSDXX	Tape and Reel, 3000
SGM2588C (Active High)	SOT-23-5	-40°C to +85°C	SGM2588CYN5G/TR	SSEX	Tape and Reel, 3000
SGM2588D (Active Low)	SOT-23-5	-40°C to +85°C	SGM2588DYN5G/TR	ST0XX	Tape and Reel, 3000
SGM2588E (Active High)	SOT-23-5	-40°C to +85°C	SGM2588EYN5G/TR	ST1XX	Tape and Reel, 3000
SGM2588F (Active Low)	SOT-23-5	-40°C to +85°C	SGM2588FYN5G/TR	ST2XX	Tape and Reel, 3000
SGM2588G (Active High)	SOT-23-5	-40°C to +85°C	SGM2588GYN5G/TR	G51XX	Tape and Reel, 3000
SGM2588I (Active High)	SOT-23-5	-40°C to +85°C	SGM2588IYN5G/TR	G52XX	Tape and Reel, 3000
SGM2588K (Active High)	SOT-23-5	-40°C to +85°C	SGM2588KYN5G/TR	G53XX	Tape and Reel, 3000

Green (RoHS & HSF): SG Micro Corp defines "Green" to mean Pb-Free (RoHS compatible) and free of halogen substances. If you have additional comments or questions, please contact your SGMICRO representative directly.

ABSOLUTE MAXIMUM RATINGS

All Pins.....	6V
$\overline{\text{FAULT}}$ Current.....	25mA
Power Dissipation, P_D @ $T_A = 25^\circ\text{C}$	
SOT-23-5.....	0.3W
Package Thermal Resistance	
SOT-23-5, θ_{JA}	280°C/W
SOT-23-5, θ_{JC}	93°C/W
Junction Temperature.....	150°C
Storage Temperature Range.....	-65°C to +150°C
Lead Temperature (Soldering, 10s).....	260°C
ESD Susceptibility	
HBM.....	2000V
MM.....	400V

RECOMMENDED OPERATING CONDITIONS

Input Voltage Range.....	2.5V to 5.5V
EN Voltage Range.....	-0.3V to 5.5V
All Other Pins.....	0V to 5.5V
Junction Temperature Range.....	-40°C to +125°C
Operating Temperature Range.....	-40°C to +85°C

MARKING INFORMATION

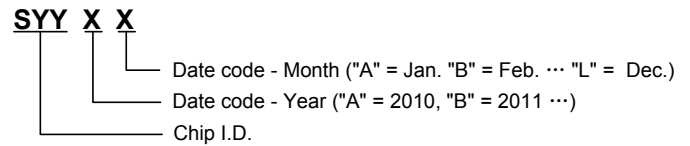

For example: SSCCA (2012, January)

OVERSTRESS CAUTION

Stresses beyond those listed may cause permanent damage to the device. Functional operation of the device at these or any other conditions beyond those indicated in the operational section of the specification is not implied. Exposure to absolute maximum rating conditions for extended periods may affect reliability.

ESD SENSITIVITY CAUTION

This integrated circuit can be damaged by ESD if you don't pay attention to ESD protection. SGMICRO recommends that all integrated circuits be handled with appropriate precautions. Failure to observe proper handling and installation procedures can cause damage. ESD damage can range from subtle performance degradation to complete device failure. Precision integrated circuits may be more susceptible to damage because very small parametric changes could cause the device not to meet its published specifications.

DISCLAIMER

SG Micro Corp reserves the right to make any change in circuit design, specification or other related things if necessary without notice at any time.

PIN CONFIGURATION

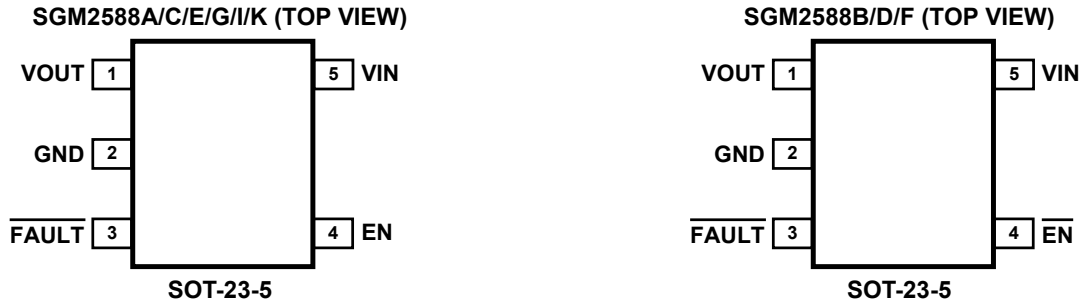

PIN DESCRIPTION

PIN	NAME	FUNCTION
1	VOUT	Output Voltage.
2	GND	Ground.
3	FAULT	Fault Flag. Active low, open-drain output. Indicates over-current or thermal shutdown conditions. Over-current condition must last longer than t_D in order to assert FAULT.
4	EN/EN	Chip Enable. Do not floating for SGM2588A/B/C/D/E/F. Active HIGH for SGM2588A/C/E/G/I/K (EN) and active LOW for SGM2588B/D/F (EN). SGM2588G/I/K have integrated a 500kΩ pull-down resistor at EN PIN.
5	VIN	Power Input Voltage.

TEST CIRCUIT

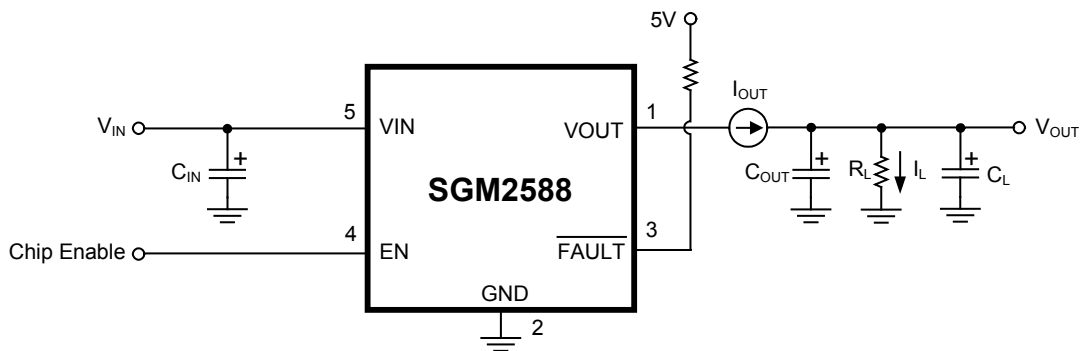

Figure 2. SGM2588 Test Circuit

ELECTRICAL CHARACTERISTICS(V_{IN} = 5V, T_A = 25°C, unless otherwise noted.)

PARAMETER		SYMBOL	CONDITIONS	MIN	TYP	MAX	UNITS
Input Voltage Range		V _{IN}		2.5		5.5	V
Quiescent Supply Current		I _Q	Switch on, V _{OUT} = open		23	35	μA
Shutdown Supply Current		I _{SD}	Switch off, V _{OUT} = open		0.1		μA
Supply Leakage Current (SGM2588A/B/C/D/E/F)		I _{LEAKAGE}	Switch off, V _{OUT} = 0V		0.1		μA
Output Leakage Current (SGM2588G/I/K)			Switch off, V _{OUT} = 5V		0.1		μA
Enable Input Threshold		V _{IH}	V _{IN} = 2.5V to 5.5V	1.6			V
		V _{IL}	V _{IN} = 2.5V to 5.5V			0.4	
Enable Input Current (SGM2588A/B/C/D/E/F)		I _{EN}	V _{EN} = 0V to 5V		0.1		μA
EN Pin Pull-Down Resistor (SGM2588G/I/K)		R _{PULL_DOWN}			500		kΩ
Switch Resistance		R _{DS(ON)}	I _{OUT} = 500mA		100		mΩ
Output Turn-On Delay Time		t _{ON}	R _L = 10Ω, C _L = 1μF, Figure 3		2.3		ms
Output Turn-Off Delay Time		t _{OFF}	R _L = 10Ω, C _L = 1μF, Figure 3		25		μs
Current Limit Threshold	SGM2588A/B/G	I _{LIM}	Ramped load	1000	1100	1200	mA
	SGM2588C/D/I		Ramped load	1890	2100	2310	
	SGM2588E/F/K		Ramped load	2300	2600	2900	
Over-Current FAULT _̄ Response Delay Time		t _D	Apply V _{OUT} = 0 until FAULT _̄ is low		13		ms
Under-Voltage Lockout Threshold		V _{UVLO}	V _{IN} rising		2.15	2.3	V
Under-Voltage Lockout Threshold Hysteresis					0.1		V
FAULT _̄ Output Resistance		R _{FAULT}	FAULT _̄ is low and I _{SINK} = 10mA		20		Ω
FAULT _̄ Leakage Current		I _{FAULT}	FAULT _̄ is high		0.1		μA
V _{OUT} Shutdown Discharge Resistance (SGM2588A/B/C/D/E/F)		R _{DIS}	Switch off		50		Ω
Thermal Shutdown Temperature			T _J increasing		150		°C
Thermal Shutdown Hysteresis					20		°C

TYPICAL PERFORMANCE CHARACTERISTICS

$V_{IN} = 5V$, $T_A = 25^\circ C$, unless otherwise noted.

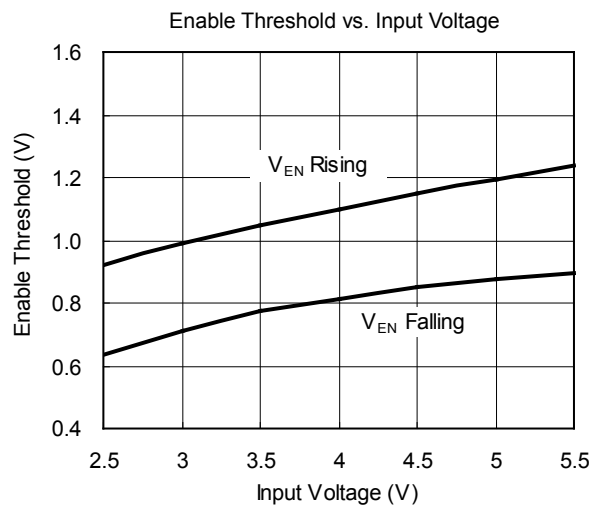
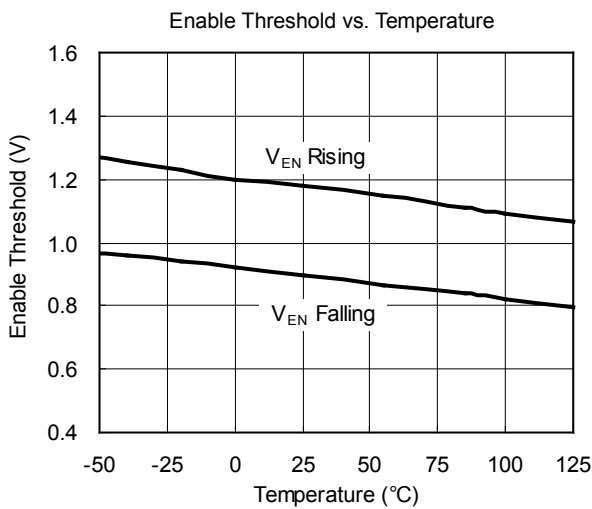
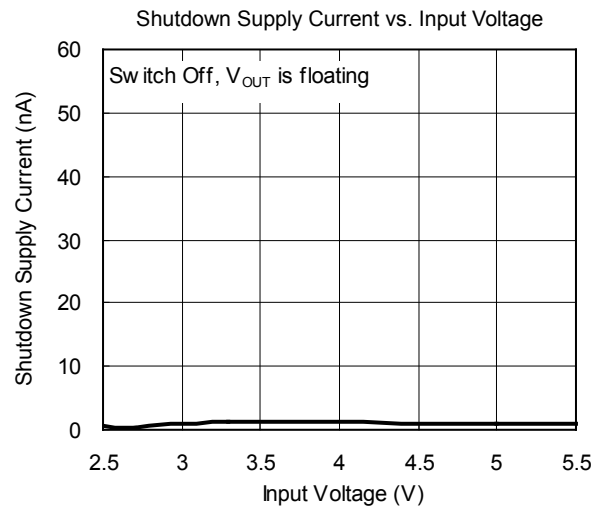
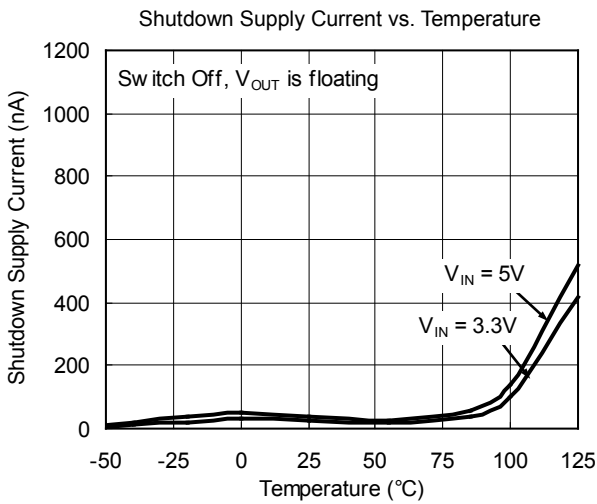
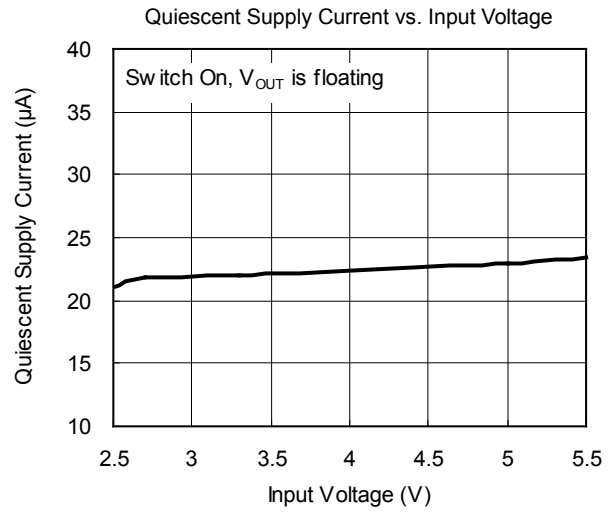
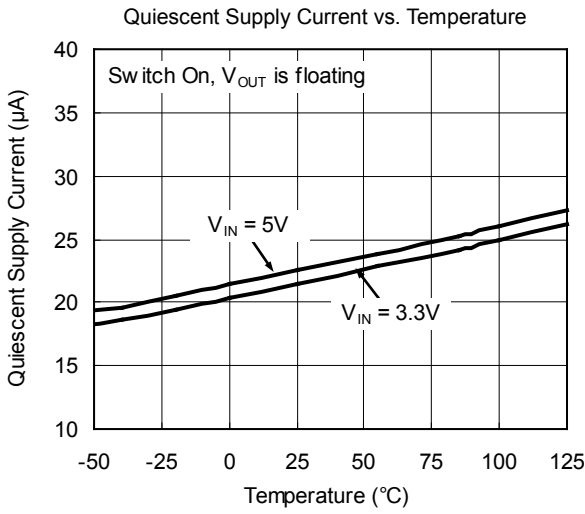

TYPICAL PERFORMANCE CHARACTERISTICS

$V_{IN} = 5V$, $T_A = 25^\circ C$, unless otherwise noted.

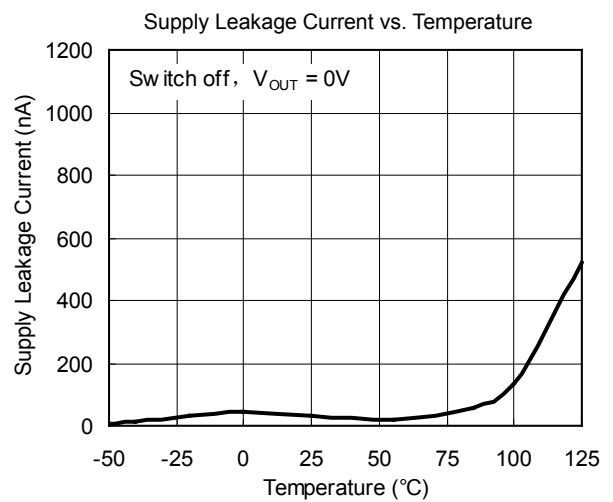
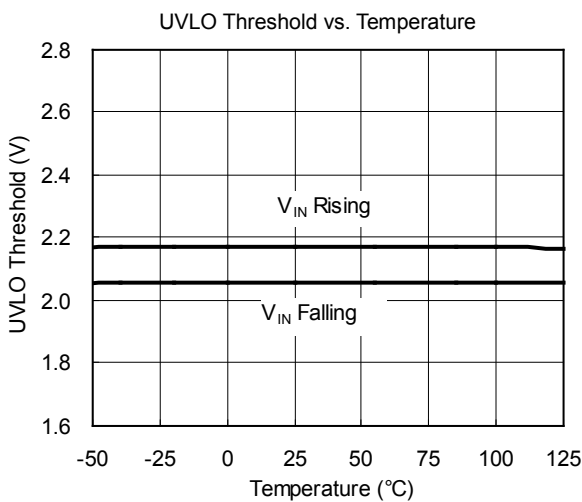
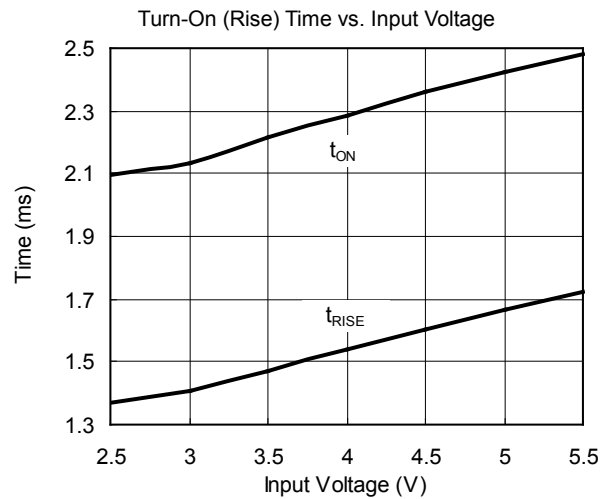
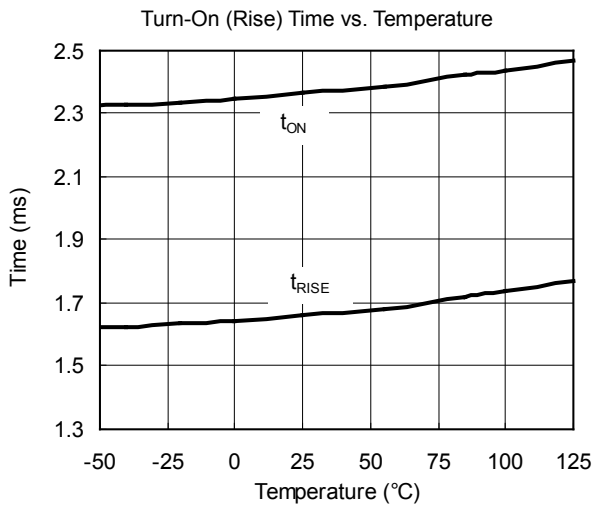
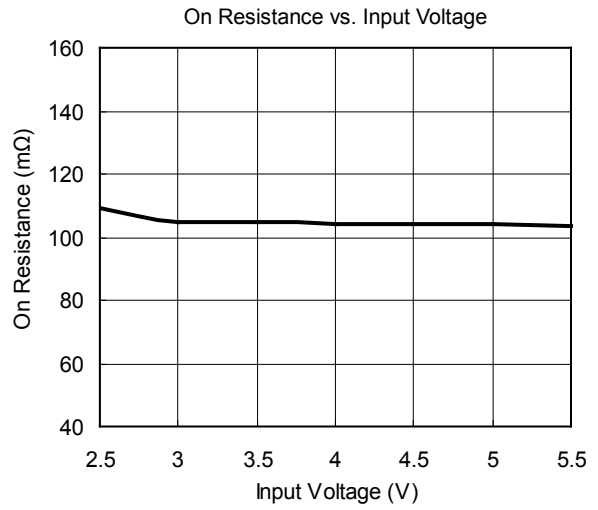
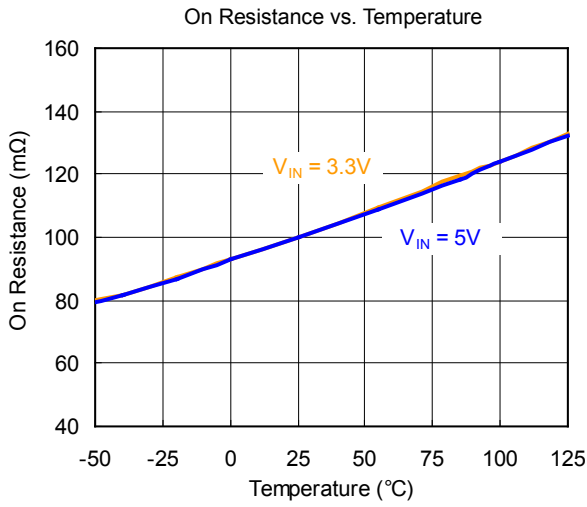

TYPICAL PERFORMANCE CHARACTERISTICS

V_{IN} = 5V, T_A = 25°C, unless otherwise noted.

Short-Circuit Current Limit vs. Temperature (SGM2588A/B/G)

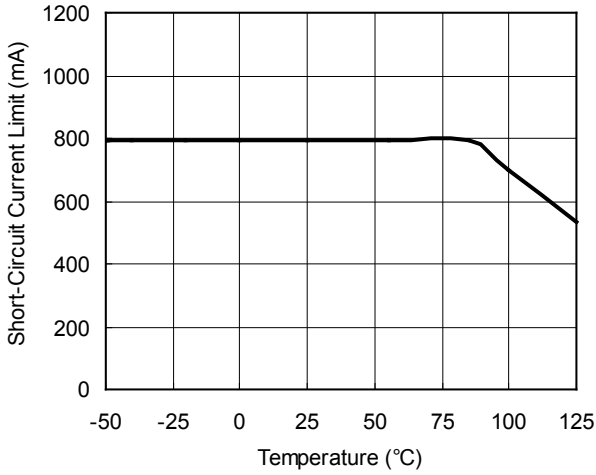

Short-Circuit Current Limit vs. Input Voltage (SGM2588A/B/G)

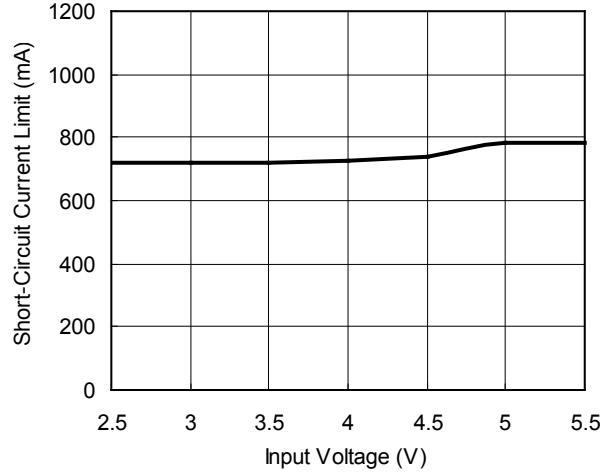

Current Limit Threshold vs. Temperature (SGM2588A/B/G)

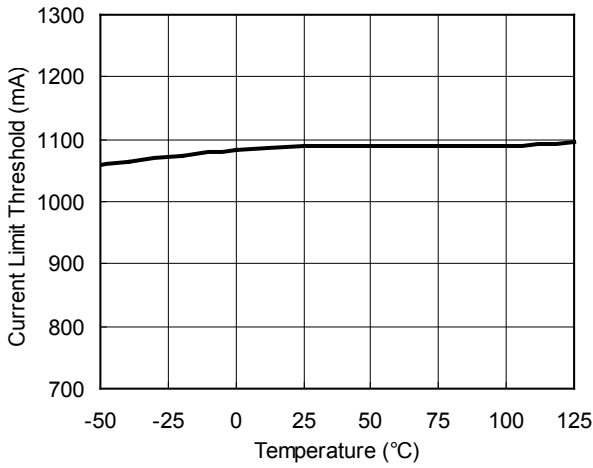

Current Limit Threshold vs. Input Voltage (SGM2588A/B/G)

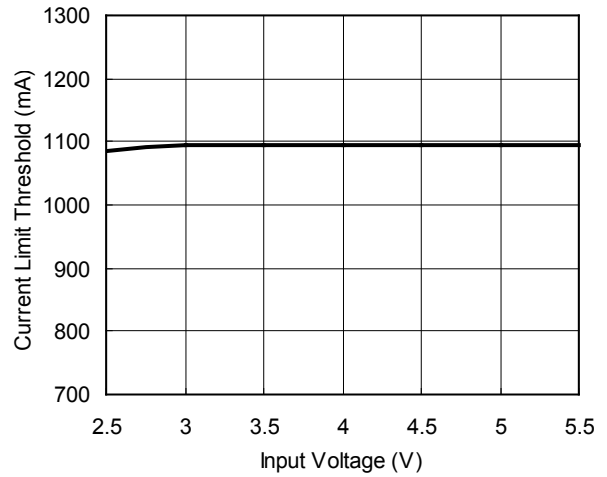

Current Limit Threshold vs. Input Voltage (SGM2588C/D/I)

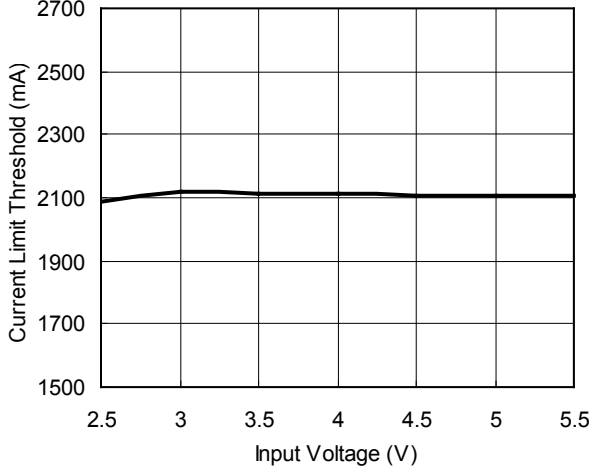

Current Limit Threshold vs. Input Voltage (SGM2588E/F/K)

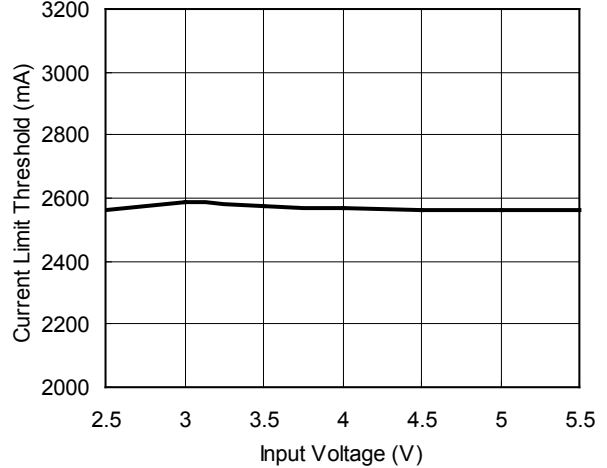

TYPICAL PERFORMANCE CHARACTERISTICS

$V_{IN} = 5V$, $T_A = 25^\circ C$, unless otherwise noted.

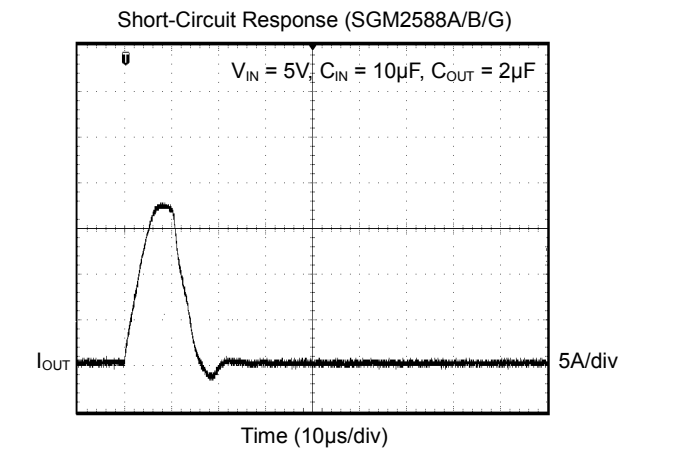
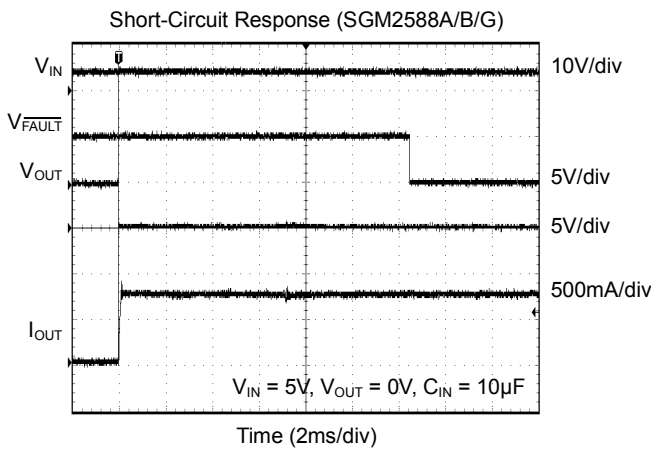
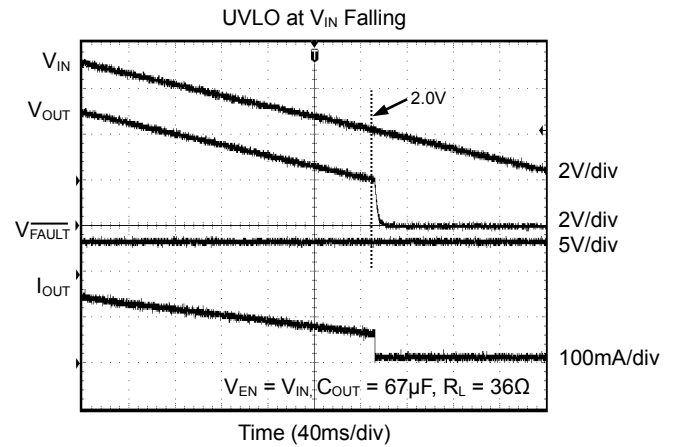
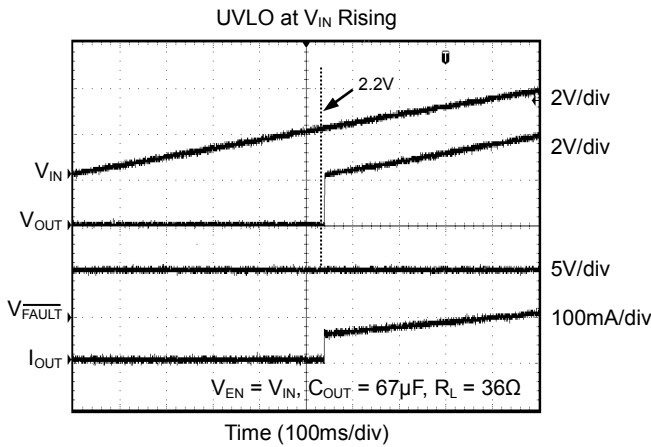
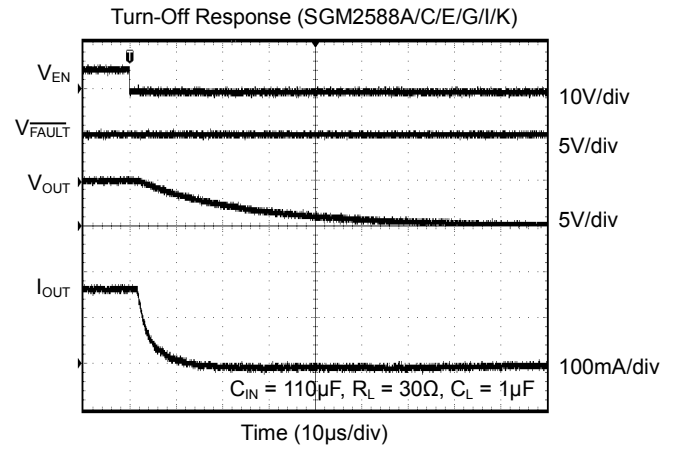
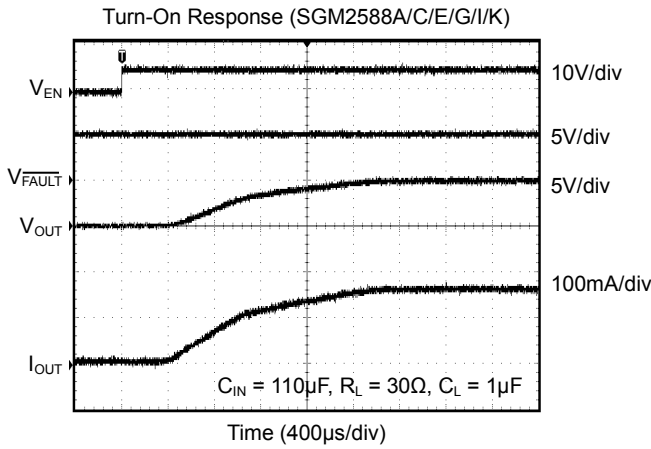

TYPICAL PERFORMANCE CHARACTERISTICS

$V_{IN} = 5V$, $T_A = 25^\circ C$, unless otherwise noted.

Enabled Into Short-Circuit (SGM2588A/G)

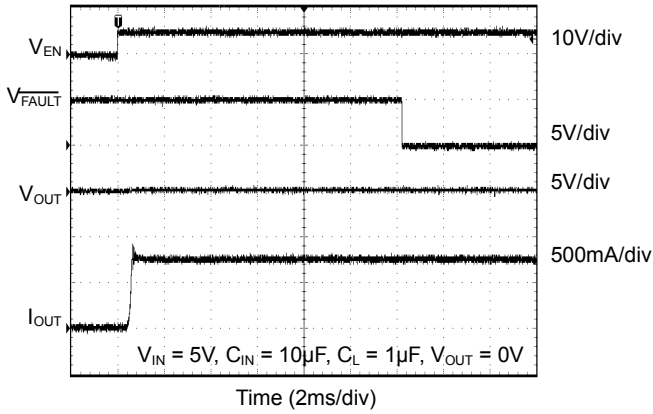

Thermal Shutdown Response (SGM2588A/G)

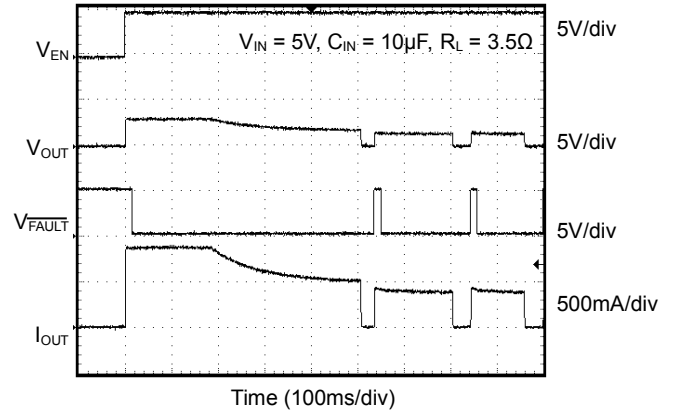

Inrush Current Response (SGM2588A/G)

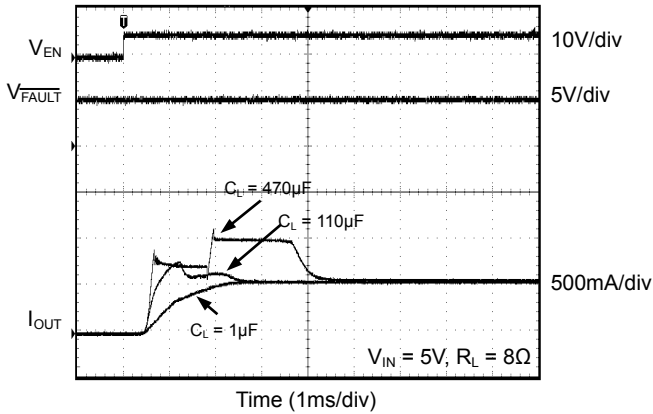

Inrush Current Response (SGM2588C/I)

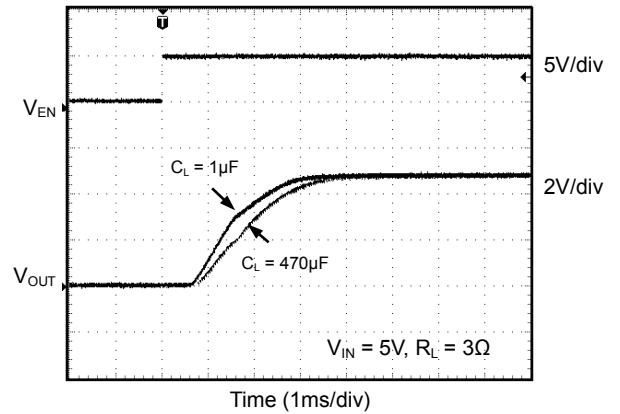

Inrush Current Response (SGM2588E/K)

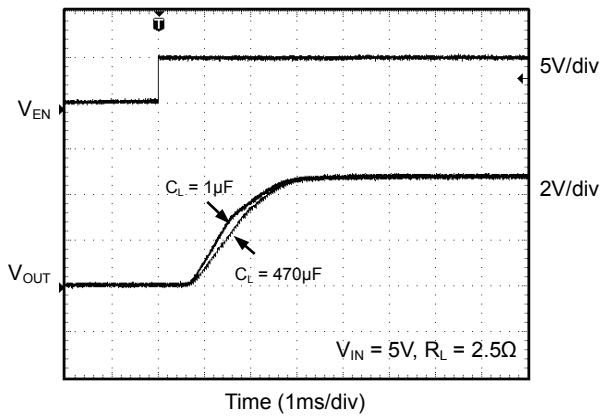

TYPICAL PERFORMANCE CHARACTERISTICS

$V_{IN} = 5V$, $T_A = 25^\circ C$, unless otherwise noted.

Capacitance Load Inrush Response (SGM2588A/B/G)

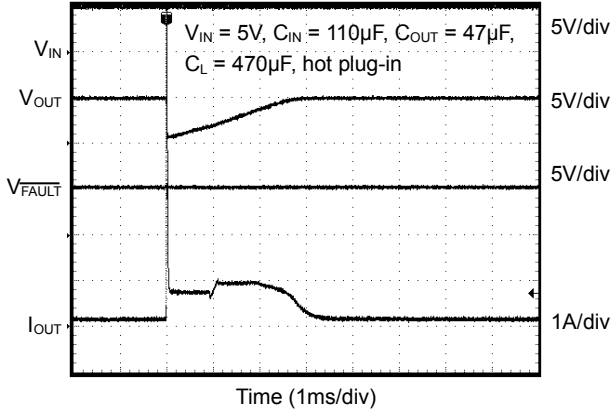

Capacitance Load Inrush Response (SGM2588A/B/G)

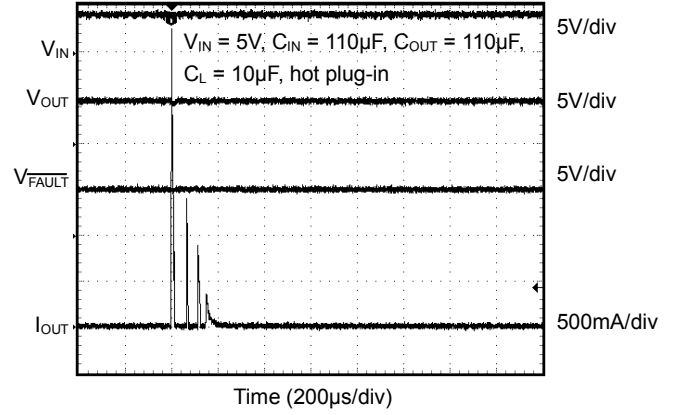

Ramped Load Response (SGM2588A/B/G)

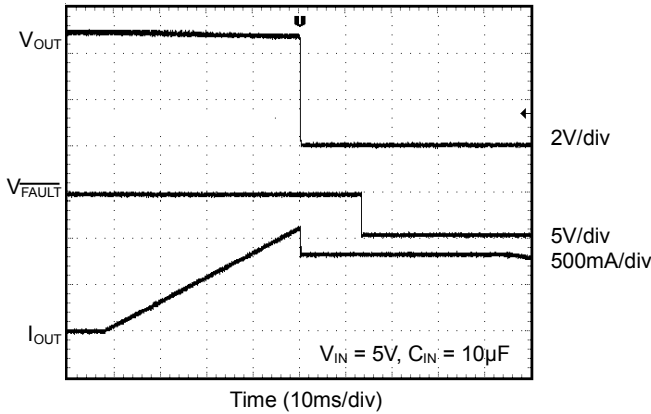

Ramped Load Response (SGM2588E/F/K)

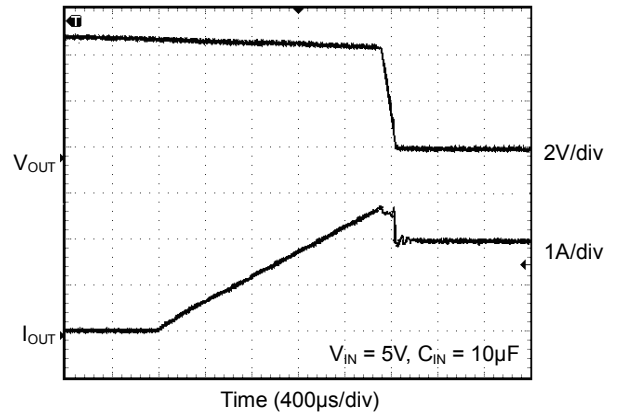

Resistance Load Inrush Response (SGM2588A/B/G)

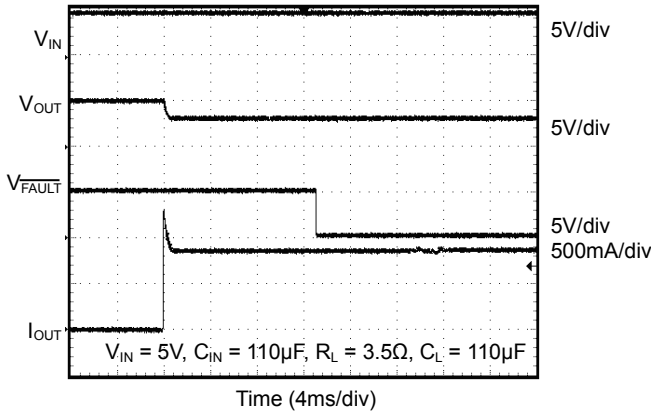

TIMING DIAGRAM



Figure 3. SGM2588A/C/E/G//K Switch Turn-On and Turn-Off Delay Times

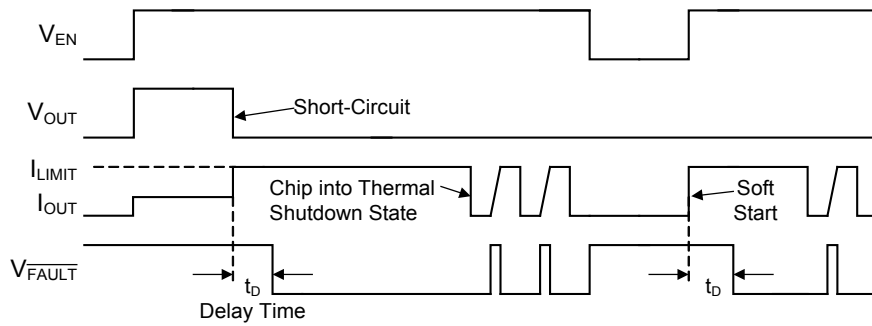

Figure 4. SGM2588A/C/E/G//K Fault Timing: Output Reset by Toggling EN

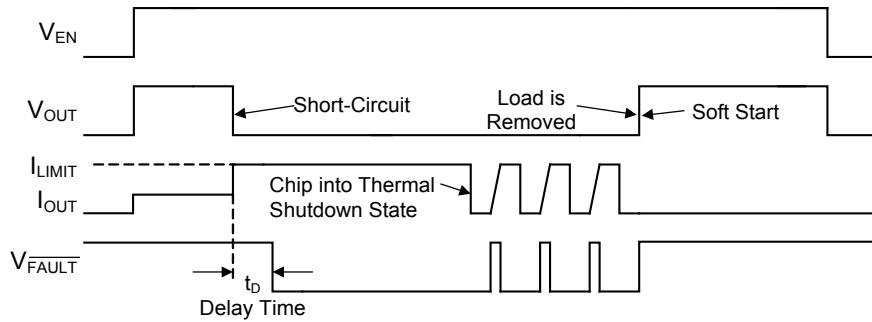

Figure 5. SGM2588A/C/E/G//K Fault Timing: Output Reset by Removing Load

FUNCTIONAL BLOCK DIAGRAM

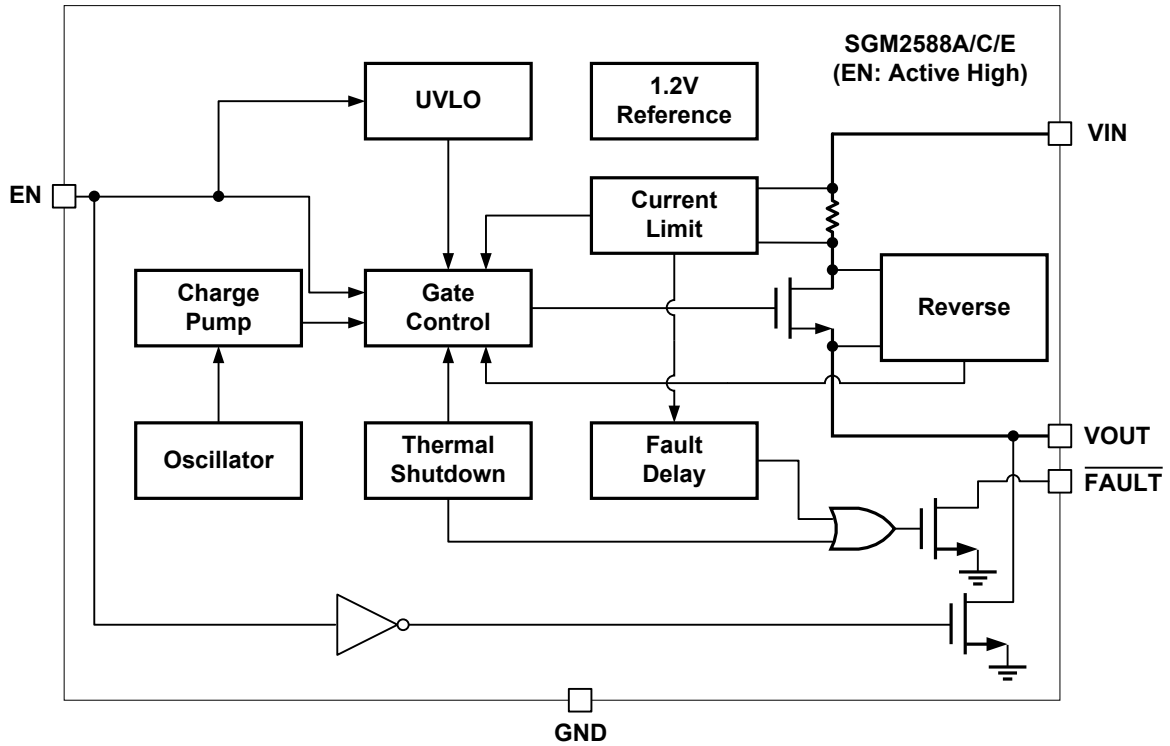

Figure 6. SGM2588A/C/E Block Diagram

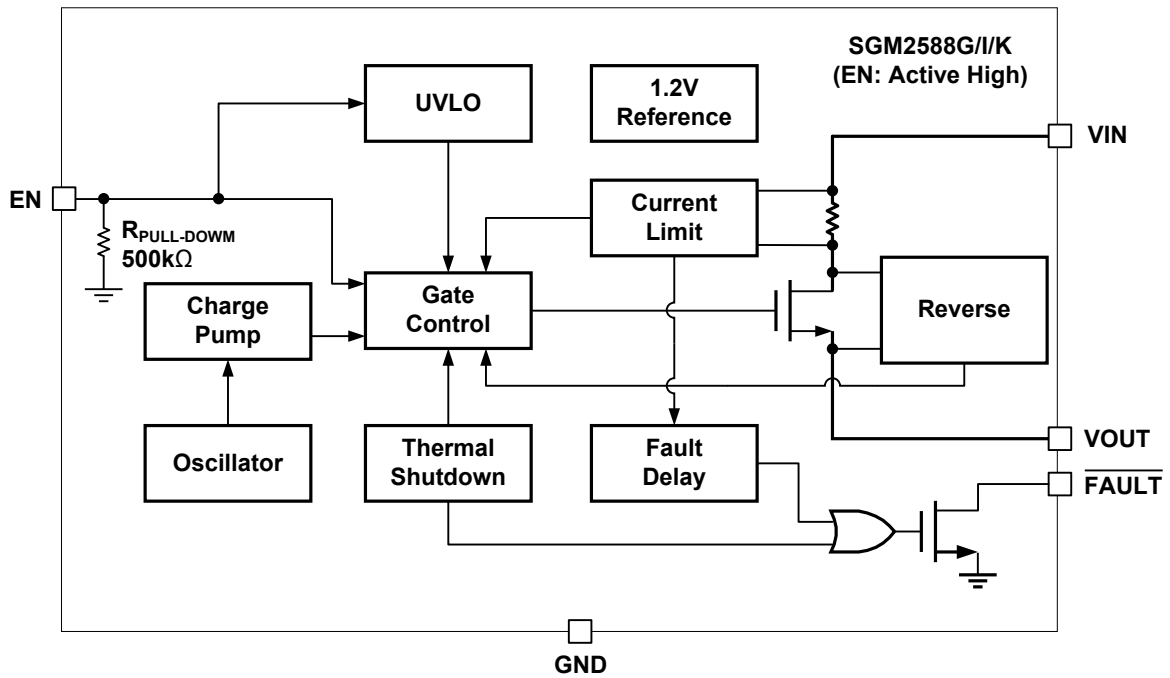

Figure 7. SGM2588G//K Block Diagram

FUNCTIONAL DESCRIPTION

Input and Output

VIN is the power supply connection to the logic circuitry and the drain of the MOSFET. VOUT is the source of the output MOSFET. In a typical circuit, current flows from VIN to VOUT toward the load. The output MOSFET and driver circuit are also designed to allow the MOSFET source to be externally forced to a higher voltage than the drain ($V_{OUT} > V_{IN}$) when the switch is disabled.

Thermal Shutdown

Thermal shutdown is employed to protect device and load from damage. It shuts off the output MOSFET and asserts the FAULT output, if the die temperature exceeds 150°C until the die temperature drops to 130°C.

Soft-Start

In order to eliminate the upstream voltage sag caused by the large inrush current during hot-plug events, the "soft-start" feature effectively isolates power supplies from such highly capacitive loads.

Under-Voltage Lockout (UVLO)

UVLO prevents the MOSFET switch from turning on until input voltage exceeds 2.15V (TYP). If input voltage drops below 2.05V (TYP), UVLO shuts off the MOSFET switch. Under-voltage detection functions only when the switch is enabled.

Current Limiting and Short Protection

The current limit circuit is designed to limit the output current to protect the upstream power supply. The typical current limit threshold is set internally to approximately 1.1A (SGM2588A/B/G), 2.1A (SGM2588C/D/I), 2.6A (SGM2588E/F/K). Under output short-circuit condition, the typical current limit folded back 75%. If SGM2588 keeps at over-current condition for a long time, the junction temperature may exceed 150°C, and over-temperature protection will shut down the output until temperature drops 130°C or limit (short) condition is removed.

Reverse-Voltage Protection

The reverse-voltage protection feature turns off the N-MOSFET switch whenever the output voltage exceeds the input voltage by 50mV (TYP). Its hysteresis voltage is 38mV (TYP).

Fault Flag (FAULT)

The FAULT signal is an open-drain N-MOSFET output. FAULT is asserted (active low) when an over-current or thermal shutdown condition occurs. Figure 4 and Figure 5 depict typical timings.

In the case of an over-current condition, FAULT will be asserted only after the response delay time (t_D) has elapsed. This ensures that FAULT is asserted only upon valid over-current conditions and that erroneous error reporting is eliminated.

For example, false over-current conditions can occur during hot-plug events when a highly capacitive load is connected and causes a high transient inrush current that exceeds the current limit threshold for up to 1ms. The FAULT response delay time t_D is 13ms (TYP).

Power Dissipation

The device's junction temperature depends on several factors such as the load, PCB layout, ambient temperature, and package type. Equations that can be used to calculate power dissipation and junction temperature are found below:

$$P_D = R_{DS(ON)} \times I_{OUT}^2$$

To relate this to junction temperature, the following equation can be used:

$$T_J = P_D \times \theta_{JA} + T_A$$

where:

T_J = junction temperature

T_A = ambient temperature

θ_{JA} = the thermal resistance of the package

APPLICATION INFORMATION

Supply Filter Capacitor

In order to prevent the input voltage drooping during hot-plug events, connect a ceramic capacitor (C_{IN}) from VIN to GND. The C_{IN} is positioned close to VIN and GND of the device. However, higher capacitor values could reduce the voltage sag on the input further. Furthermore, an output short will cause ringing on the input without the input capacitor. It could destroy the internal circuitry when the input transient exceeds 6V which is the absolute maximum supply voltage even for a short duration.

If the upstream supply cable is long or the VIN transient exceeds 6V during the VOUT short, recommend adding a second filter capacitor (not less than 47 μ F) at the upstream supply output terminal.

Output Filter Capacitor

Between VOUT and GND, connect a low-ESR 10 μ F ceramic capacitor to meet the 330mV maximum drop requirement. Standard bypass methods should be used to minimize inductance and resistance between the bypass capacitor and the down-stream connector. This will reduce EMI and improve the transient performance. If long cables are connected to the output terminals, an anti-parallel schottky diode such as BAT54 is suggested to be placed in parallel with the output terminals to absorb the negative ringing due to the cable inductance.

PCB Layout Guide

For best performance of the SGM2588, the following guidelines must be strictly followed:

- Keep all V_{BUS} traces as short and wide as possible and use at least 2 ounce copper for all V_{BUS} traces.
- Place a ground plane under all circuitry to lower both resistance and inductance and improve DC and transient performance.
- Dual low-ESR 10 μ F ceramic capacitors between VOUT and GND, VIN and GND.
- Locate the output capacitor as close to the connectors as possible to lower impedance (mainly inductance) between the port and the capacitor and improve transient performance.
- Input and output capacitors should be placed closed to the IC and connected to ground plane to reduce noise coupling.
- Locate the ceramic bypass capacitors as close as possible to the VIN pin and VOUT pin of SGM2588.

PACKAGE INFORMATION

PACKAGE OUTLINE DIMENSIONS

SOT-23-5

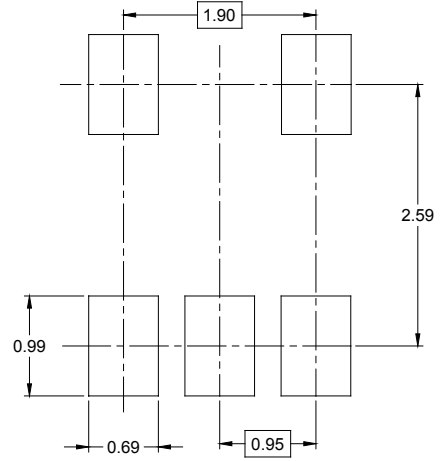
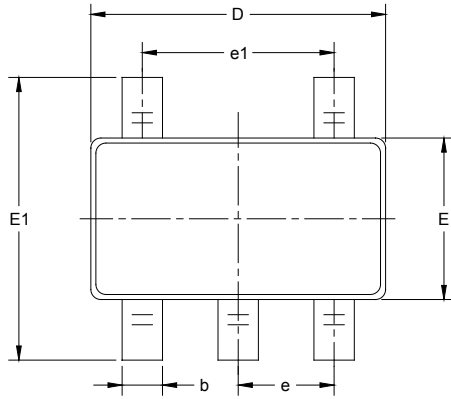

RECOMMENDED LAND PATTERN (Unit: mm)

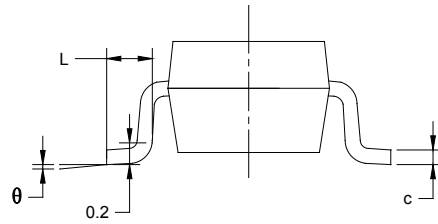
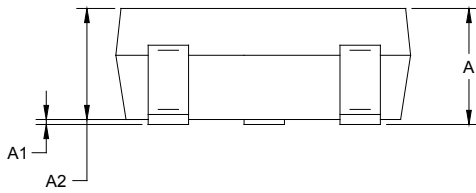

Symbol	Dimensions In Millimeters		Dimensions In Inches	
	MIN	MAX	MIN	MAX
A	1.050	1.250	0.041	0.049
A1	0.000	0.100	0.000	0.004
A2	1.050	1.150	0.041	0.045
b	0.300	0.500	0.012	0.020
c	0.100	0.200	0.004	0.008
D	2.820	3.020	0.111	0.119
E	1.500	1.700	0.059	0.067
E1	2.650	2.950	0.104	0.116
e	0.950 BSC		0.037 BSC	
e1	1.900 BSC		0.075 BSC	
L	0.300	0.600	0.012	0.024
θ	0°	8°	0°	8°

PACKAGE INFORMATION

TAPE AND REEL INFORMATION

REEL DIMENSIONS

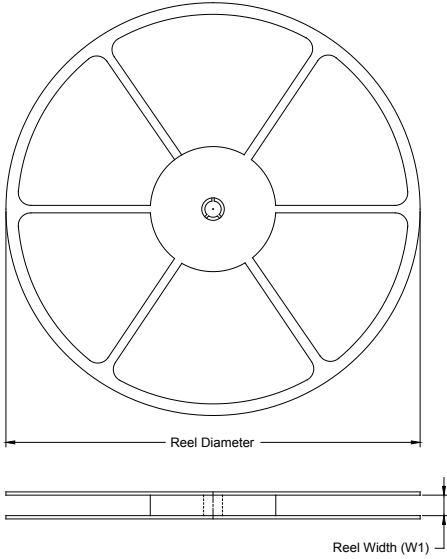

TAPE DIMENSIONS

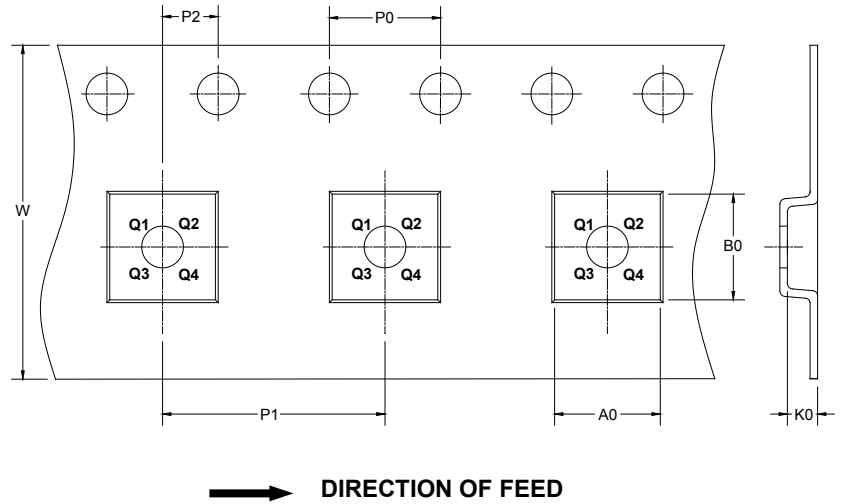

NOTE: The picture is only for reference. Please make the object as the standard.

KEY PARAMETER LIST OF TAPE AND REEL

Package Type	Reel Diameter	Reel Width W1 (mm)	A0 (mm)	B0 (mm)	K0 (mm)	P0 (mm)	P1 (mm)	P2 (mm)	W (mm)	Pin1 Quadrant
SOT-23-5	7"	9.5	3.2	3.2	1.4	4.0	4.0	2.0	8.0	Q3

DD0001

PACKAGE INFORMATION

CARTON BOX DIMENSIONS



NOTE: The picture is only for reference. Please make the object as the standard.

KEY PARAMETER LIST OF CARTON BOX

Reel Type	Length (mm)	Width (mm)	Height (mm)	Pizza/Carton
7" (Option)	368	227	224	8
7"	442	410	224	18

DD0002