

LM393B、LM2903B、LM193、LM293、LM393 和 LM2903 双路比较器

1 特性

- 新增了 [LM393B](#) 和 [LM2903B](#)
- 改进了 B 版本的规格
 - 最大额定值：高达 38V
 - ESD 等级 (HBM)：2kV
 - 低输入失调电压：0.37mV
 - 低输入偏置电流：3.5nA
 - 低电源电流：每个比较器 200 μ A
 - 更短的响应时间 (1 微秒)
 - [LM393B](#) 的工作温度范围
 - 采用 2 x 2mm 微型 WSON 封装
- B 版本可直接取代 [LM293](#)、[LM393](#) 和 [LM2903](#) 的 A 和 V 版本
- 共模输入电压范围包括接地
- 差分输入电压范围等于最大额定电源电压： $\pm 38V$
- 低输出饱和电压
- 输出与 TTL、MOS 和 CMOS 兼容

2 应用

- [扫地机器人](#)
- [单相 UPS](#)
- [服务器 PSU](#)
- [无线电动工具](#)
- [无线基础设施](#)
- [电器](#)
- [楼宇自动化](#)
- [工厂自动化与控制](#)
- [电机驱动器](#)
- [信息娱乐系统与仪表组](#)

3 说明

[LM393B](#) 和 [LM2903B](#) 器件是业界通用 [LM393](#) 和 [LM2903](#) 比较器系列的下一代版本。下一代 B 版本比较器为成本敏感型应用提供了卓越的价值，具有更低的失调电压、更高的电源电压能力、更低的电源电流、更低的输入偏置电流和更低的传播延迟，并通过专用 ESD 钳位提高了 2kV ESD 性能和输入耐用性。[LM393B](#) 和 [LM2903B](#) 可直接替代 [LM293](#)、[LM393](#) 和 [LM2903](#) (“A” 和 “V” 版本)。

所有器件都包含两个独立的电压比较器，这些比较器可在宽电压范围内由单电源供电运行。静态电流与电源电压无关，输出可连接至其他集电极开路输出，以实现线与逻辑。

器件信息

| 器件型号 | 封装 ⁽¹⁾ | 封装尺寸 (标称值) |
|--|-------------------|-----------------|
| LM393B、LM2903B、LM193、LM293、LM293A、LM393、LM393A、LM2903、LM2903V、LM2903AV | SOIC (8) | 4.90mm x 3.91mm |
| LM393B、LM2903B、LM293、LM293A、LM393、LM393A、LM2903 | VSSOP (8) | 3.00mm x 3.00mm |
| LM293、LM393、LM393A、LM2903 | PDIP (8) | 9.81mm x 6.35mm |
| LM393、LM393A、LM2903 | SO (8) | 6.20mm x 5.30mm |
| LM393B、LM2903B、LM393、LM393A、LM2903、LM2903V、LM2903AV | TSSOP (8) | 3.00mm x 4.40mm |
| LM393B | SOT-23 (8) | 2.90mm x 1.60mm |
| LM393B、LM2903B | WSON (8) | 2.00mm x 2.00mm |

(1) 如需了解所有可用封装，请参阅数据表末尾的可订购产品附录。

Table of Contents

| | | | |
|--|----|---|----|
| 1 特性..... | 1 | 7.14 Typical Characteristics, LMx93, LM2903 (all 'V' and 'A' suffixes)..... | 12 |
| 2 应用..... | 1 | 7.15 Typical Characteristics, LM393B and LM2903B..... | 13 |
| 3 说明..... | 1 | 8 Detailed Description | 19 |
| 4 Revision History..... | 2 | 8.1 Overview..... | 19 |
| 5 Family Comparison Table..... | 3 | 8.2 Functional Block Diagram..... | 19 |
| 6 Pin Configuration and Functions..... | 4 | 8.3 Feature Description..... | 19 |
| 7 Specifications..... | 5 | 8.4 Device Functional Modes..... | 19 |
| 7.1 Absolute Maximum Ratings..... | 5 | 9 Application and Implementation | 20 |
| 7.2 ESD Ratings..... | 5 | 9.1 Application Information..... | 20 |
| 7.3 Recommended Operating Conditions..... | 6 | 9.2 Typical Application..... | 20 |
| 7.4 Thermal Information: LM193..... | 6 | 10 Power Supply Recommendations | 23 |
| 7.5 Thermal Information: LM293, LM393, LM2903 (all 'V' and 'A' suffixes)..... | 6 | 11 Layout | 23 |
| 7.6 Thermal Information: LM393B and LM2903B..... | 7 | 11.1 Layout Guidelines..... | 23 |
| 7.7 Electrical Characteristics LM393B..... | 7 | 11.2 Layout Example..... | 23 |
| 7.8 Electrical Characteristics LM2903B..... | 8 | 12 Device and Documentation Support | 24 |
| 7.9 Switching Characteristics LM393B and LM2903B..... | 8 | 12.1 Related Links..... | 24 |
| 7.10 Electrical Characteristics for LM193, LM293, and LM393 (without A suffix)..... | 9 | 12.2 Receiving Notification of Documentation Updates..... | 24 |
| 7.11 Electrical Characteristics for LM293A and LM393A..... | 10 | 12.3 Support Resources..... | 24 |
| 7.12 Electrical Characteristics for LM2903, LM2903V, and LM2903AV..... | 11 | 12.4 Trademarks..... | 24 |
| 7.13 Switching Characteristics: LM193, LM293, LM393, LM2903, all 'A' and 'V' versions..... | 11 | 12.5 Electrostatic Discharge Caution..... | 24 |
| | | 12.6 Glossary..... | 24 |
| | | 13 Mechanical, Packaging, and Orderable Information | 24 |

4 Revision History

注：以前版本的页码可能与当前版本的页码不同

| Changes from Revision AC (February 2020) to Revision AD (October 2020) | Page |
|--|------|
| • 更新了整个文档的表、图和交叉参考的编号格式。..... | 1 |

| Changes from Revision AB (December 2019) to Revision AC (February 2020) | Page |
|---|------|
| • 更改了首页的“特性”、“应用”和“说明”文本，以突出 B 版本..... | 1 |
| • 添加了 WSON 和 SOT-23-8 封装..... | 1 |
| • Added Links to Family Table | 3 |
| • Added DDF and DSG pgs to Thermal Table..... | 7 |

| Changes from Revision AA (September 2019) to Revision AB (December 2019) | Page |
|--|------|
| • 将 LM393B 和 LM2903B 的状态从“预发布”更改为“正在供货” | 1 |
| • Added Family Comparison Table..... | 3 |

| Changes from Revision Z (October 2017) to Revision AA (September 2019) | Page |
|--|------|
| • 在整个数据表中添加了“B”器件并更改了多处文本..... | 1 |
| • 删除了“器件信息”中旧的 LM193 CDIP 和 LCCC 封装参考和图，这些内容包含在 LM139-MIL 数据表中..... | 1 |
| • Added "B" devices Thermal Information table..... | 7 |
| • Added "B" device electrical tables..... | 7 |
| • Added "B" device graphs | 13 |

5 Family Comparison Table

| Specification | LM393B | LM2903B | LM393 LM393A | LM2903 | LM2903V LM2903AV | LM193 | LM293 LM293A | Units |
|---|------------|------------|-----------------|------------|---------------------|------------|-----------------|-------|
| Supply Voltage | 3 to 36 | 3 to 36 | 2 to 30 | 2 to 30 | 2 to 32 | 2 to 30 | 2 to 30 | V |
| Total Supply Current (5V to 36V max) | 0.6 to 0.8 | 0.6 to 0.8 | 1 to 2.5 | 1 to 2.5 | 1 to 2.5 | 1 to 2.5 | 1 to 2.5 | mA |
| Temperature Range | -40 to 85 | -40 to 125 | 0 to 70 | -40 to 125 | -40 to 125 | -55 to 125 | -25 to 85 | °C |
| ESD (HBM) | 2000 | 2000 | 1000 | 1000 | 1000 | 1000 | 1000 | V |
| Offset Voltage (Max over temp) | ± 4 | ± 4 | ± 9 ± 4 | ± 15 | ± 15 ± 4 | ± 9 | ± 9 ± 4 | V |
| Input Bias Current (typ / max) | 3.5 / 25 | 3.5 / 25 | 25 / 250 | 25 / 250 | 25 / 250 | 25 / 100 | 25 / 250 | nA |
| Response Time (typ) | 1 | 1 | 1.3 | 1.3 | 1.3 | 1.3 | 1.3 | µsec |

6 Pin Configuration and Functions



图 6-1. D, DGK, JG, P, PS, DDF or PW Package 8-Pin SOIC, VSSOP, PDIP, SO, or TSSOP Top View



Connect thermal pad directly to GND pin.

图 6-2. DSG Package 8-Pin WSON With Exposed Pad Top View

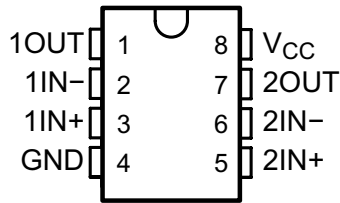
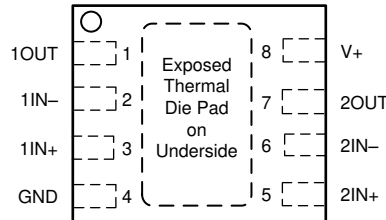
表 6-1. Pin Functions

| NAME | PIN | | I/O | DESCRIPTION |
|-----------------|--------------------------------------|-----|--------|------------------------------------|
| | SOIC, VSSOP, PDIP, SO, DDF and TSSOP | DSG | | |
| 1OUT | 1 | 1 | Output | Output pin of comparator 1 |
| 1IN - | 2 | 2 | Input | Negative input pin of comparator 1 |
| 1IN+ | 3 | 3 | Input | Positive input pin of comparator 1 |
| GND | 4 | 4 | — | Ground |
| 2IN+ | 5 | 5 | Input | Positive input pin of comparator 2 |
| 2IN- | 6 | 6 | Input | Negative input pin of comparator 2 |
| 2OUT | 7 | 7 | Output | Output pin of comparator 2 |
| V _{CC} | 8 | 8 | — | Positive Supply |
| Thermal Pad | — | PAD | — | Connect directly to GND pin |

7 Specifications

7.1 Absolute Maximum Ratings

over operating free-air temperature range (unless otherwise noted) ⁽¹⁾

| | | MIN | MAX | UNIT |
|------------------|---|-----------------|-----|------|
| V _{CC} | Supply voltage ⁽²⁾ | Non-B Versions | 36 | V |
| | | B Versions Only | 38 | |
| V _{ID} | Differential input voltage ⁽³⁾ | Non-B Versions | 36 | V |
| | | B Versions Only | 38 | |
| V _I | Input voltage (either input) | Non-B Versions | 36 | V |
| | | B Versions Only | 38 | |
| I _{IK} | Input current ⁽⁵⁾ | | -50 | mA |
| V _O | Output voltage | Non-B Versions | 36 | V |
| | | B Versions Only | 38 | |
| I _O | Output current | Non-B Versions | 20 | mA |
| | | B Versions Only | 25 | |
| I _{SC} | Duration of output short circuit to ground ⁽⁴⁾ | Unlimited | | |
| T _J | Operating virtual-junction temperature | | 150 | °C |
| T _{stg} | Storage temperature | - 65 | 150 | °C |

- (1) Stresses beyond those listed under *Absolute Maximum Ratings* may cause permanent damage to the device. These are stress ratings only, and functional operation of the device at these or any other conditions beyond those indicated under *Recommended Operating Conditions* is not implied. Exposure to absolute-maximum-rated conditions for extended periods may affect device reliability. Production Processing Does Not Necessarily Include Testing of All Parameters.
- (2) All voltage values, except differential voltages, are with respect to network ground.
- (3) Differential voltages are at IN+ with respect to IN - .
- (4) Short circuits from outputs to V_{CC} can cause excessive heating and eventual destruction.
- (5) Input current flows thorough parasitic diode to ground and turns on parasitic transistors that increases I_{CC} and may cause output to be incorrect. Normal operation resumes when input current is removed.

7.2 ESD Ratings

| | | VALUE | UNIT |
|--------------------------------|-------------------------|--|-------|
| LM393B and LM2903B Only | | | |
| V _(ESD) | Electrostatic discharge | Human body model (HBM), per ANSI/ESDA/JEDEC JS-001 ⁽¹⁾ | ±2000 |
| | | Charged-device model (CDM), per JEDEC specification JESD22-C101 ⁽²⁾ | ±1000 |
| All Other Versions | | | |
| V _(ESD) | Electrostatic discharge | Human body model (HBM), per ANSI/ESDA/JEDEC JS-001 ⁽¹⁾ | ±1000 |
| | | Charged-device model (CDM), per JEDEC specification JESD22-C101 ⁽²⁾ | ±750 |

- (1) JEDEC document JEP155 states that 500-V HBM allows safe manufacturing with a standard ESD control process.
- (2) JEDEC document JEP157 states that 250-V CDM allows safe manufacturing with a standard ESD control process.

7.3 Recommended Operating Conditions

Over operating free-air temperature range (unless otherwise noted)

| | | MIN | MAX | UNIT |
|-------------------------------------|------------------------------------|------|--------------|------|
| Supply voltage, $V_S = (V+) - (V-)$ | non-V devices | 2 | 30 | V |
| | V devices | 2 | 32 | |
| | "B" version devices | 3 | 36 | |
| Input voltage range, V_{IVR} | non-B devices | 0 | $(V+) - 2.0$ | V |
| | "B" version devices | -0.1 | | |
| Ambient temperature, T_A | LM193 | -55 | 125 | °C |
| | LM2903, LM2903V, LM2903AV, LM2903B | -40 | 125 | |
| | LM393B | -40 | 85 | |
| | LM293, LM293A | -25 | 85 | |
| | LM393, LM393A | 0 | 70 | |

7.4 Thermal Information: LM193

| THERMAL METRIC ⁽¹⁾ | | LM193 | UNIT |
|-------------------------------|--|----------|------|
| | | D (SOIC) | |
| | | 8 pin | |
| $R_{\theta JA}$ | Junction-to-ambient thermal resistance | 126.4 | °C/W |
| $R_{\theta JC(top)}$ | Junction-to-case (top) thermal resistance | 70 | °C/W |
| $R_{\theta JB}$ | Junction-to-board thermal resistance | 64.9 | °C/W |
| ψ_{JT} | Junction-to-top characterization parameter | 20.3 | °C/W |
| ψ_{JB} | Junction-to-board characterization parameter | 64.5 | °C/W |
| $R_{\theta JC(bot)}$ | Junction-to-case (bottom) thermal resistance | n/a | °C/W |

(1) For more information about traditional and new thermal metrics, see the [Semiconductor and IC Package Thermal Metrics](#) application report.

7.5 Thermal Information: LM293, LM393, LM2903 (all 'V' and 'A' suffixes)

| THERMAL METRIC ⁽¹⁾ | | LM293, LM393, LM2903 | | | | | UNIT |
|-------------------------------|--|----------------------|-------------|----------|---------|------------|------|
| | | D (SOIC) | DGK (VSSOP) | P (PDIP) | PS (SO) | PW (TSSOP) | |
| | | 8 pin | 8 pin | 8 pin | 8 pin | 8 pin | |
| $R_{\theta JA}$ | Junction-to-ambient thermal resistance | 131.8 | 199.4 | 73.7 | 139 | 194.1 | °C/W |
| $R_{\theta JC(top)}$ | Junction-to-case (top) thermal resistance | 78.4 | 90.2 | 62.6 | 98.9 | 77.0 | °C/W |
| $R_{\theta JB}$ | Junction-to-board thermal resistance | 72.2 | 120.8 | 50.8 | 83.7 | 123.0 | °C/W |
| ψ_{JT} | Junction-to-top characterization parameter | 26.5 | 21.5 | 39.2 | 47.4 | 13.1 | °C/W |
| ψ_{JB} | Junction-to-board characterization parameter | 71.1 | 119.1 | 50.7 | 83 | 121.3 | °C/W |

(1) For more information about traditional and new thermal metrics, see the [Semiconductor and IC Package Thermal Metrics](#) application report.

7.6 Thermal Information: LM393B and LM2903B

| THERMAL METRIC ⁽¹⁾ | | LM393B, LM2903B | | | | | UNIT |
|-------------------------------|--|-----------------|------------|-------------|--------------|------------|------|
| | | D (SOIC) | PW (TSSOP) | DGK (VSSOP) | DDF (SOT-23) | DSG (WSON) | |
| | | 8 pin | 8 pin | 8 pin | 8 pin | 8 pins | |
| R _{θJA} | Junction-to-ambient thermal resistance | 148.5 | 200.6 | 193.7 | 197.9 | 96.9 | °C/W |
| R _{θJC(top)} | Junction-to-case (top) thermal resistance | 90.2 | 89.6 | 82.9 | 119.2 | 119.0 | °C/W |
| R _{θJB} | Junction-to-board thermal resistance | 91.8 | 131.3 | 115.5 | 115.4 | 63.1 | °C/W |
| ψ _{JT} | Junction-to-top characterization parameter | 38.5 | 22.1 | 20.8 | 19.4 | 12.4 | °C/W |
| ψ _{JB} | Junction-to-board characterization parameter | 91.1 | 129.6 | 113.9 | 113.7 | 63.0 | °C/W |
| R _{θJC(bot)} | Junction-to-case (bottom) thermal resistance | - | - | - | - | 37.8 | °C/W |

(1) For more information about traditional and new thermal metrics, see the [Semiconductor and IC Package Thermal Metrics](#) application report.

7.7 Electrical Characteristics LM393B

V_S = 5 V, V_{CM} = (V -); T_A = 25°C (unless otherwise noted).

| PARAMETER | | TEST CONDITIONS | MIN | TYP | MAX | UNIT |
|---------------------|---|---|-------|------------|------|------|
| V _{IO} | Input offset voltage | V _S = 5 to 36V | - 2.5 | ±0.37 | 2.5 | mV |
| | | V _S = 5 to 36V, T _A = - 40°C to +85°C | - 4 | | 4 | |
| I _B | Input bias current | | | - 3.5 | - 25 | nA |
| | | T _A = - 40°C to +85°C | | | - 50 | nA |
| I _{OS} | Input offset current | | - 10 | ±0.5 | 10 | nA |
| | | T _A = - 40°C to +85°C | - 25 | | 25 | nA |
| V _{CM} | Common mode range | V _S = 3 to 36V | (V -) | (V+) - 1.5 | | V |
| V _{CM} | Common mode range | V _S = 3 to 36V, T _A = - 40°C to +85°C | (V -) | (V+) - 2.0 | | V |
| A _{VD} | Large signal differential voltage amplification | V _S = 15V, V _O = 1.4V to 11.4V; R _L ≥ 15k to (V+) | 50 | 200 | | V/mV |
| V _{OL} | Low level output Voltage {swing from (V -)} | I _{SINK} ≤ 4mA, V _{ID} = -1V | | 110 | 400 | mV |
| | | I _{SINK} ≤ 4mA, V _{ID} = -1V T _A = - 40°C to +85°C | | | 550 | mV |
| I _{OH-LKG} | High-level output leakage current | (V+) = V _O = 5 V; V _{ID} = 1V | | 0.1 | 20 | nA |
| | | (V+) = V _O = 36V; V _{ID} = 1V | | 0.3 | 50 | nA |
| I _{OL} | Low level output current | V _{OL} = 1.5V; V _{ID} = -1V; V _S = 5V | 6 | 21 | | mA |
| I _Q | Quiescent current (all comparators) | V _S = 5 V, no load | | 400 | 600 | μA |
| | | V _S = 36 V, no load, T _A = - 40°C to +85°C | | 550 | 800 | μA |

7.8 Electrical Characteristics LM2903B

$V_S = 5\text{ V}$, $V_{CM} = (V^-)$; $T_A = 25^\circ\text{C}$ (unless otherwise noted).

| PARAMETER | | TEST CONDITIONS | MIN | TYP | MAX | UNIT |
|--------------|---|---|-----------|------------|-----------------|---------------|
| V_{IO} | Input offset voltage | $V_S = 5\text{ to }36\text{V}$ | - 2.5 | ± 0.37 | 2.5 | mV |
| | | $V_S = 5\text{ to }36\text{V}$, $T_A = -40^\circ\text{C to }+125^\circ\text{C}$ | - 4 | | 4 | |
| I_B | Input bias current | | | - 3.5 | - 25 | nA |
| | | $T_A = -40^\circ\text{C to }+125^\circ\text{C}$ | | | - 50 | nA |
| I_{OS} | Input offset current | | - 10 | ± 0.5 | 10 | nA |
| | | $T_A = -40^\circ\text{C to }+125^\circ\text{C}$ | - 25 | | 25 | nA |
| V_{CM} | Common mode range | $V_S = 3\text{ to }36\text{V}$ | (V^-) | | (V^+) - 1.5 | V |
| | | $V_S = 3\text{ to }36\text{V}$, $T_A = -40^\circ\text{C to }+125^\circ\text{C}$ | (V^-) | | (V^+) - 2.0 | V |
| A_{VD} | Large signal differential voltage amplification | $V_S = 15\text{V}$, $V_O = 1.4\text{V to }11.4\text{V}$; $R_L \geq 15\text{k to }(V^+)$ | 50 | 200 | | V/mV |
| V_{OL} | Low level output Voltage {swing from (V^-)} | $I_{SINK} \leq 4\text{mA}$, $V_{ID} = -1\text{V}$ | | 110 | 400 | mV |
| | | $I_{SINK} \leq 4\text{mA}$, $V_{ID} = -1\text{V}$ $T_A = -40^\circ\text{C to }+125^\circ\text{C}$ | | | 550 | mV |
| I_{OH-LKG} | High-level output leakage current | (V^+) = $V_O = 5\text{V}$; $V_{ID} = 1\text{V}$ | | 0.1 | 20 | nA |
| | | (V^+) = $V_O = 36\text{V}$; $V_{ID} = 1\text{V}$ | | 0.3 | 50 | nA |
| I_{OL} | Low level output current | $V_{OL} = 1.5\text{V}$; $V_{ID} = -1\text{V}$; $V_S = 5\text{V}$ | 6 | 21 | | mA |
| I_Q | Quiescent current (all comparators) | $V_S = 5\text{ V}$, no load | | 400 | 600 | μA |
| | | $V_S = 36\text{ V}$, no load, $T_A = -40^\circ\text{C to }+125^\circ\text{C}$ | | 550 | 800 | μA |

7.9 Switching Characteristics LM393B and LM2903B

$V_S = 5\text{V}$, $V_O\text{ PULLUP} = 5\text{V}$, $V_{CM} = V_S/2$, $C_L = 15\text{pF}$, $R_L = 5.1\text{k Ohm}$, $T_A = 25^\circ\text{C}$ (unless otherwise noted).

| PARAMETER | | TEST CONDITIONS | MIN | TYP | MAX | UNIT |
|-----------------------|--|---|-----|------|-----|------|
| t_{response} | Propagation delay time, high-to-low; TTL input signal ⁽¹⁾ | TTL input with $V_{\text{ref}} = 1.4\text{V}$ | | 300 | | ns |
| t_{response} | Propagation delay time, high-to-low; Small scale input signal ⁽¹⁾ | Input overdrive = 5mV, Input step = 100mV | | 1000 | | ns |

(1) High-to-low and low-to-high refers to the transition at the input.

7.10 Electrical Characteristics for LM193, LM293, and LM393 (without A suffix)

at specified free-air temperature, $V_{CC} = 5\text{ V}$ (unless otherwise noted)

| PARAMETER | TEST CONDITIONS | T_A (1) | LM193 | | | LM293 LM393 | | | UNIT | |
|--|---|------------------------|------------------------|-----|------|------------------------|------|------|---------------|----|
| | | | MIN | TYP | MAX | MIN | TYP | MAX | | |
| V_{IO} Input offset voltage | $V_{CC} = 5\text{ V to }30\text{ V}$, $V_{IC} = V_{ICR\text{ min}}$, $V_O = 1.4\text{ V}$ | 25°C | | 2 | 5 | | 2 | 5 | mV | |
| | | Full range | | | 9 | | 9 | | | |
| I_{IO} Input offset current | $V_O = 1.4\text{ V}$ | 25°C | | 3 | 25 | | 5 | 50 | nA | |
| | | Full range | | | 100 | | 250 | | | |
| I_{IB} Input bias current | $V_O = 1.4\text{ V}$ | 25°C | | -25 | -100 | | -25 | -250 | nA | |
| | | Full range | | | -300 | | -400 | | | |
| V_{ICR} Common-mode input-voltage range(2) | | 25°C | 0 to $V_{CC} - 1.5$ | | | 0 to $V_{CC} - 1.5$ | | | V | |
| | | Full range | 0 to $V_{CC} - 2$ | | | 0 to $V_{CC} - 2$ | | | | |
| A_{VD} Large-signal differential-voltage amplification | $V_{CC} = 15\text{ V}$, $V_O = 1.4\text{ V to }11.4\text{ V}$, $R_L \geq 15\text{ k}\Omega$ to V_{CC} | 25°C | | 50 | 200 | | 50 | 200 | V/mV | |
| I_{OH} High-level output current | $V_{OH} = 5\text{ V}$ | $V_{ID} = 1\text{ V}$ | 25°C | | 0.1 | | 0.1 | 50 | nA | |
| | $V_{OH} = 30\text{ V}$ | $V_{ID} = 1\text{ V}$ | Full range | | | 1 | | 1 | μA | |
| V_{OL} Low-level output voltage | $I_{OL} = 4\text{ mA}$, $V_{ID} = -1\text{ V}$ | 25°C | | 150 | 400 | | 130 | 400 | mV | |
| | | Full range | | | 700 | | 700 | | | |
| I_{OL} Low-level output current | $V_{OL} = 1.5\text{ V}$, $V_{ID} = -1\text{ V}$ | 25°C | | 6 | | | 6 | | mA | |
| I_{CC} Supply current | $R_L = \infty$ | $V_{CC} = 5\text{ V}$ | 25°C | | 0.8 | 1 | | 0.45 | 1 | mA |
| | | $V_{CC} = 30\text{ V}$ | Full range | | | 2.5 | | 0.55 | 2.5 | |

- (1) Full range (minimum or maximum) for LM193 is -55°C to 125°C , for LM293 is -25°C to 85°C , and for LM393 is 0°C to 70°C . All characteristics are measured with zero common-mode input voltage, unless otherwise specified.
- (2) The voltage at either input should not be allowed to go negative by more than 0.3 V otherwise output may be incorrect and excessive input current can flow. The upper end of the common-mode voltage range is limited by $V_{CC} - 2\text{V}$. However only one input needs to be in the valid common mode range, the other input can go up the maximum V_{CC} level and the comparator provides a proper output state. Either or both inputs can go to maximum V_{CC} level without damage.

7.11 Electrical Characteristics for LM293A and LM393A

at specified free-air temperature, $V_{CC} = 5\text{ V}$ (unless otherwise noted)

| PARAMETER | TEST CONDITIONS | T_A ⁽¹⁾ | LM293A LM393A | | | UNIT |
|--|---|------------------------|------------------|------------------------|-------|---------------|
| | | | MIN | TYP | MAX | |
| V_{IO} Input offset voltage | $V_{CC} = 5\text{ V to }30\text{ V}, V_O = 1.4\text{ V}$ $V_{IC} = V_{ICR(min)}$ | 25°C | | 1 | 2 | mV |
| | | Full range | | | 4 | |
| I_{IO} Input offset current | $V_O = 1.4\text{ V}$ | 25°C | | 5 | 50 | nA |
| | | Full range | | | 150 | |
| I_{IB} Input bias current | $V_O = 1.4\text{ V}$ | 25°C | | - 25 | - 250 | nA |
| | | Full range | | | - 400 | |
| V_{ICR} Common-mode input-voltage range ⁽²⁾ | | 25°C | | 0 to $V_{CC} - 1.5$ | | V |
| | | Full range | | 0 to $V_{CC} - 2$ | | |
| A_{VD} Large-signal differential-voltage amplification | $V_{CC} = 15\text{ V}, V_O = 1.4\text{ V to }11.4\text{ V},$ $R_L \geq 15\text{ k}\Omega\text{ to }V_{CC}$ | 25°C | | 50 | 200 | V/mV |
| I_{OH} High-level output current | $V_{OH} = 5\text{ V}, V_{ID} = 1\text{ V}$ | 25°C | | 0.1 | 50 | nA |
| | $V_{OH} = 30\text{ V}, V_{ID} = 1\text{ V}$ | Full range | | | 1 | μA |
| V_{OL} Low-level output voltage | $I_{OL} = 4\text{ mA}, V_{ID} = - 1\text{ V}$ | 25°C | | 110 | 400 | mV |
| | | Full range | | | 700 | |
| I_{OL} Low-level output current | $V_{OL} = 1.5\text{ V}, V_{ID} = - 1\text{ V},$ | 25°C | | 6 | | mA |
| I_{CC} Supply current | $R_L = \infty$ | $V_{CC} = 5\text{ V}$ | 25°C | 0.60 | 1 | mA |
| | | $V_{CC} = 30\text{ V}$ | Full range | 0.72 | 2.5 | |

- (1) Full range (minimum or maximum) for LM293A is $- 25^\circ\text{C}$ to 85°C , and for LM393A is 0°C to 70°C . All characteristics are measured with zero common-mode input voltage, unless otherwise specified.
- (2) The voltage at either input should not be allowed to go negative by more than 0.3 V otherwise output may be incorrect and excessive input current can flow. The upper end of the common-mode voltage range is limited by $V_{CC} - 2\text{V}$. However only one input needs to be in the valid common mode range, the other input can go up the maximum V_{CC} level and the comparator provides a proper output state. Either or both inputs can go to maximum V_{CC} level without damage.

7.12 Electrical Characteristics for LM2903, LM2903V, and LM2903AV

at specified free-air temperature, $V_{CC} = 5\text{ V}$ (unless otherwise noted)

| PARAMETER | TEST CONDITIONS | T_A ⁽¹⁾ | LM2903, LM2903V | | | LM2903AV | | | UNIT | |
|--|---|-----------------------|-----------------|------------------------|------|----------|------------------------|------|---------------|----|
| | | | MIN | TYP | MAX | MIN | TYP | MAX | | |
| V_{IO} Input offset voltage | $V_{CC} = 5\text{ V to MAX}^{(2)}$, $V_O = 1.4\text{ V}$, $V_{IC} = V_{ICR(min)}$ | 25°C | | 2 | 7 | | 1 | 2 | mV | |
| | | Full range | | | 15 | | | 4 | | |
| I_{IO} Input offset current | $V_O = 1.4\text{ V}$ | 25°C | | 5 | 50 | | 5 | 50 | nA | |
| | | Full range | | | 200 | | | 200 | | |
| I_{IB} Input bias current | $V_O = 1.4\text{ V}$ | 25°C | | -25 | -250 | | -25 | -250 | nA | |
| | | Full range | | | -500 | | | -500 | | |
| V_{ICR} Common-mode input-voltage range ⁽³⁾ | | 25°C | | 0 to $V_{CC} - 1.5$ | | | 0 to $V_{CC} - 1.5$ | | V | |
| | | Full range | | 0 to $V_{CC} - 2$ | | | 0 to $V_{CC} - 2$ | | | |
| A_{VD} Large-signal differential-voltage amplification | $V_{CC} = 15\text{ V}$, $V_O = 1.4\text{ V to } 11.4\text{ V}$, $R_L \geq 15\text{ k}\Omega\text{ to } V_{CC}$ | 25°C | | 25 | 100 | | 25 | 100 | V/mV | |
| I_{OH} High-level output current | $V_{OH} = 5\text{ V}$, $V_{ID} = 1\text{ V}$ $V_{OH} = V_{CC}\text{ MAX}^{(2)}$, $V_{ID} = 1\text{ V}$ | 25°C | | 0.1 | 50 | | 0.1 | 50 | nA | |
| | | Full range | | | 1 | | | 1 | μA | |
| V_{OL} Low-level output voltage | $I_{OL} = 4\text{ mA}$, $V_{ID} = -1\text{ V}$ | 25°C | | 150 | 400 | | 150 | 400 | mV | |
| | | Full range | | | 700 | | | 700 | | |
| I_{OL} Low-level output current | $V_{OL} = 1.5\text{ V}$, $V_{ID} = -1\text{ V}$ | 25°C | | 6 | | | 6 | | mA | |
| I_{CC} Supply current | $R_L = \infty$ | $V_{CC} = 5\text{ V}$ | 25°C | | 0.8 | 1 | | 0.8 | 1 | mA |
| | | $V_{CC} = \text{MAX}$ | Full range | | | 2.5 | | | 2.5 | |

- (1) Full range (minimum or maximum) for LM2903 is -40°C to 125°C . All characteristics are measured with zero common-mode input voltage, unless otherwise specified.
- (2) $V_{CC}\text{ MAX} = 30\text{ V}$ for non-V devices and 32 V for V-suffix devices.
- (3) The voltage at either input should not be allowed to go negative by more than 0.3 V otherwise output may be incorrect and excessive input current can flow. The upper end of the common-mode voltage range is limited by $V_{CC} - 2\text{V}$. However only one input needs to be in the valid common mode range, the other input can go up the maximum V_{CC} level and the comparator provides a proper output state. Either or both inputs can go to maximum V_{CC} level without damage.

7.13 Switching Characteristics: LM193, LM239, LM393, LM2903, all 'A' and 'V' versions

$V_{CC} = 5\text{ V}$, $T_A = 25^\circ\text{C}$

| PARAMETER | TEST CONDITIONS | TYP | UNIT | |
|---------------|---|---------------------------------------|------|---------------|
| Response time | R_L connected to 5 V through $5.1\text{ k}\Omega$, $C_L = 15\text{ pF}^{(1)(2)}$ | 100-mV input step with 5-mV overdrive | 1.3 | μs |
| | | TTL-level input step | 0.3 | |

- (1) C_L includes probe and jig capacitance.
- (2) The response time specified is the interval between the input step function and the instant when the output crosses 1.4 V .

7.14 Typical Characteristics, LMx93, LM2903 (all 'V' and 'A' suffixes)

$T_A = 25^\circ\text{C}$, $V_S = 5\text{V}$, $R_{\text{PULLUP}} = 5.1\text{k}$, $C_L = 15\text{pF}$, $V_{\text{CM}} = 0\text{V}$ unless otherwise noted.



图 7-1. Supply Current vs Supply Voltage



图 7-2. Input Bias Current vs Supply Voltage

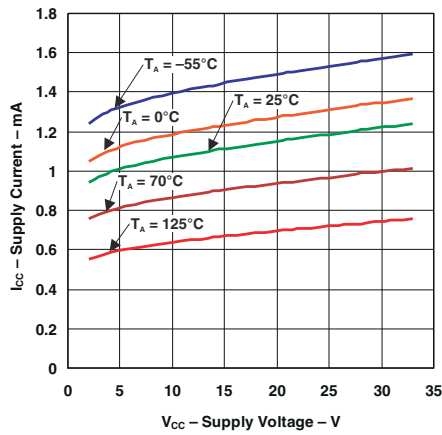

图 7-3. Output Saturation Voltage

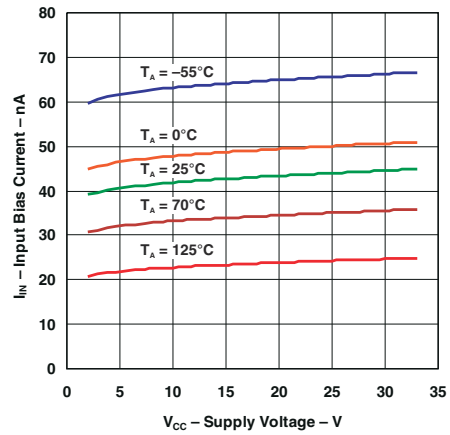

图 7-4. Response Time for Various Overdrives Negative Transition

7.14 Typical Characteristics, LMx93, LM2903 (all 'V' and 'A' suffixes) (continued)

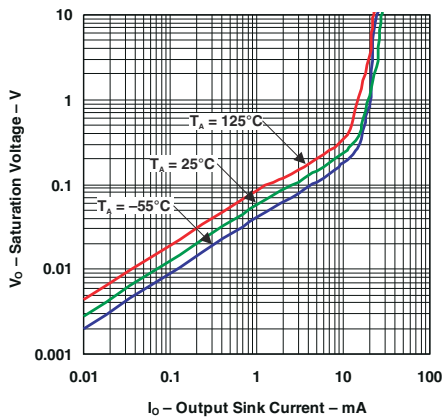
$T_A = 25^\circ\text{C}$, $V_S = 5\text{V}$, $R_{\text{PULLUP}} = 5.1\text{k}$, $C_L = 15\text{pF}$, $V_{\text{CM}} = 0\text{V}$ unless otherwise noted.

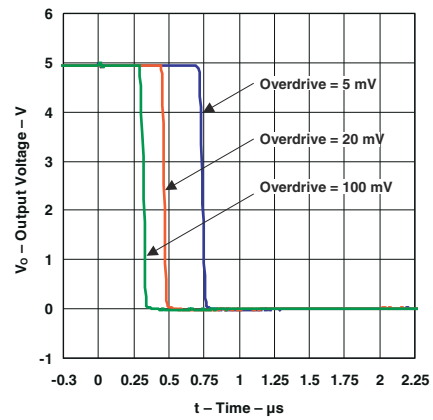

图 7-5. Response Time for Various Overdrives Positive Transition

7.15 Typical Characteristics, LM393B and LM2903B

$T_A = 25^\circ\text{C}$, $V_S = 5\text{V}$, $R_{\text{PULLUP}} = 5.1\text{k}$, $C_L = 15\text{pF}$, $V_{\text{CM}} = 0\text{V}$, $V_{\text{UNDERDRIVE}} = 100\text{mV}$, $V_{\text{OVERDRIVE}} = 100\text{mV}$ unless otherwise noted.

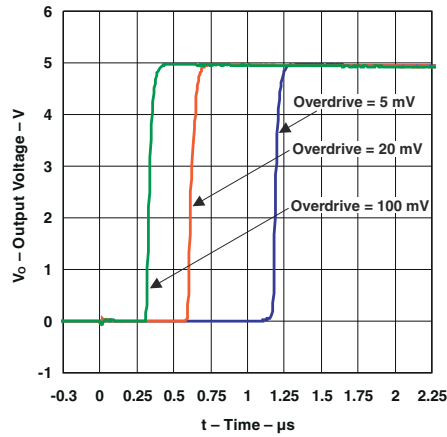

图 7-6. Total Supply Current vs. Supply Voltage



图 7-7. Total Supply Current vs. Input Voltage at 3V

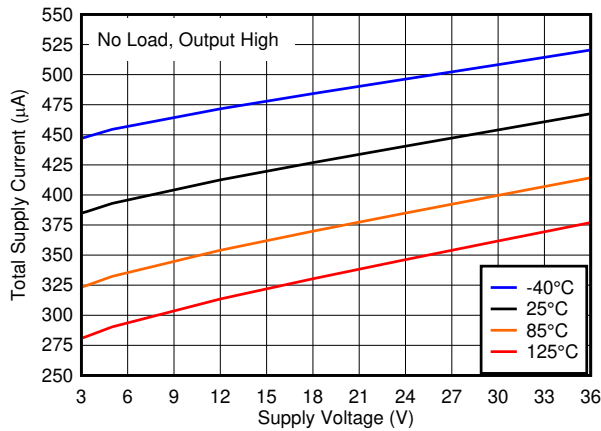

图 7-8. Total Supply Current vs. Input Voltage at 3.3V

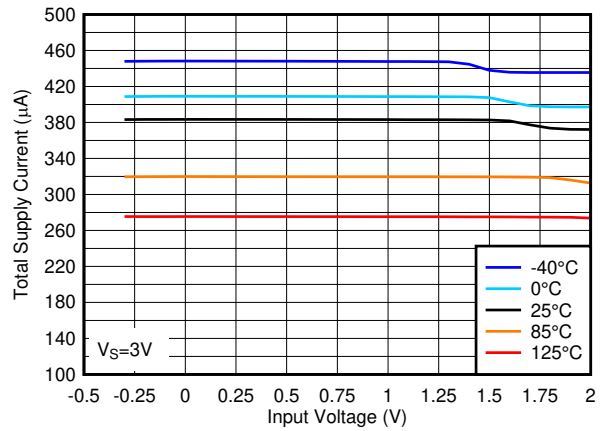

图 7-9. Total Supply Current vs. Input Voltage at 5V

7.15 Typical Characteristics, LM393B and LM2903B (continued)

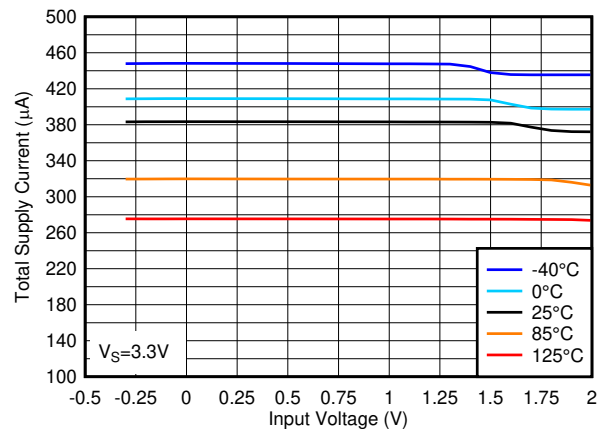
$T_A = 25^\circ\text{C}$, $V_S = 5\text{ V}$, $R_{\text{PULLUP}} = 5.1\text{ k}$, $C_L = 15\text{ pF}$, $V_{\text{CM}} = 0\text{ V}$, $V_{\text{UNDERDRIVE}} = 100\text{ mV}$, $V_{\text{OVERDRIVE}} = 100\text{ mV}$ unless otherwise noted.

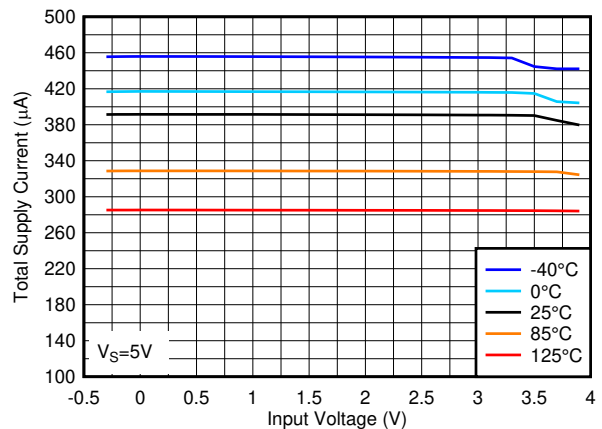

图 7-10. Total Supply Current vs. Input Voltage at 12V



图 7-11. Total Supply Current vs. Input Voltage at 36V

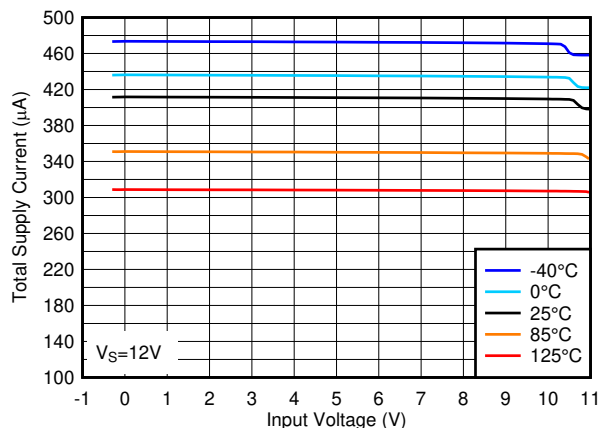

图 7-12. Input Offset Voltage vs. Temperature at 3V

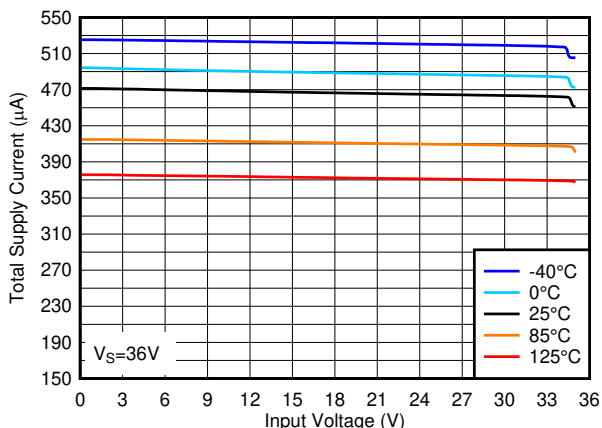

图 7-13. Input Offset Voltage vs. Temperature at 5V

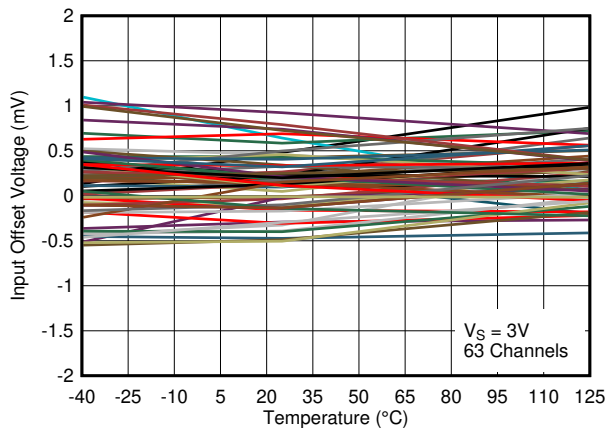

图 7-14. Input Offset Voltage vs. Temperature at 12V

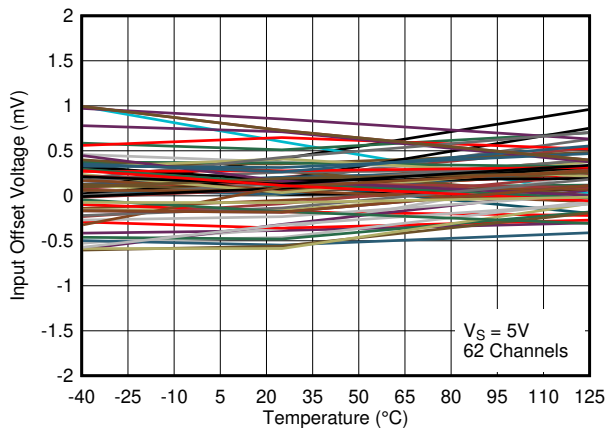

图 7-15. Input Offset Voltage vs. Temperature at 36V

7.15 Typical Characteristics, LM393B and LM2903B (continued)

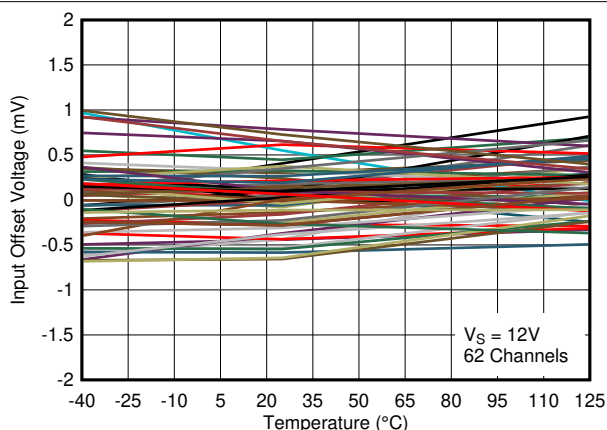
$T_A = 25^\circ\text{C}$, $V_S = 5\text{ V}$, $R_{\text{PULLUP}} = 5.1\text{ k}\Omega$, $C_L = 15\text{ pF}$, $V_{\text{CM}} = 0\text{ V}$, $V_{\text{UNDERDRIVE}} = 100\text{ mV}$, $V_{\text{OVERDRIVE}} = 100\text{ mV}$ unless otherwise noted.

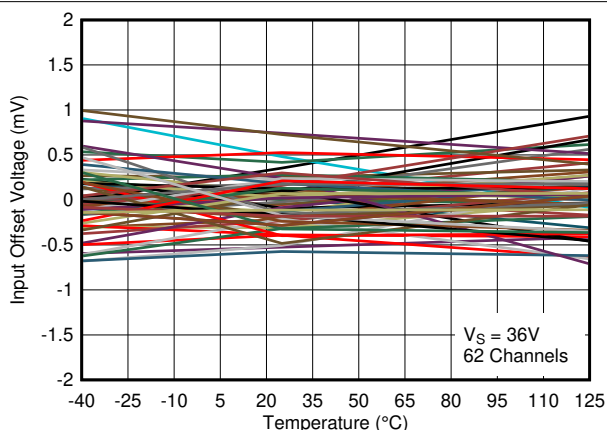

图 7-16. Input Offset Voltage vs. Supply Voltage at -40°C



图 7-17. Input Offset Voltage vs. Supply Voltage at 25°C

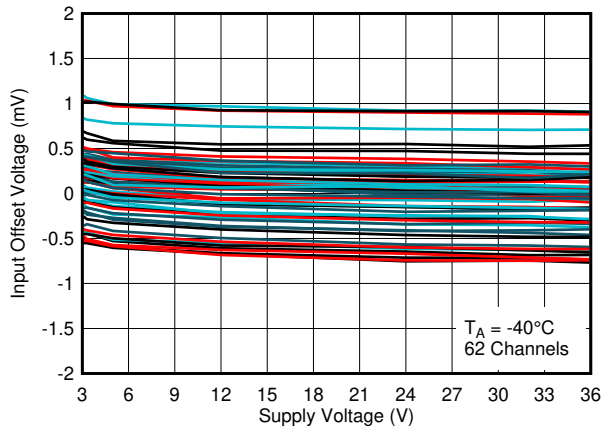

图 7-18. Input Offset Voltage vs. Supply Voltage at 85°C

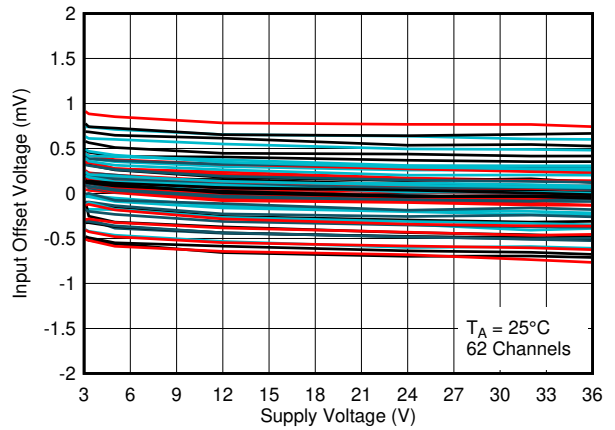

图 7-19. Input Offset Voltage vs. Supply Voltage at 125°C

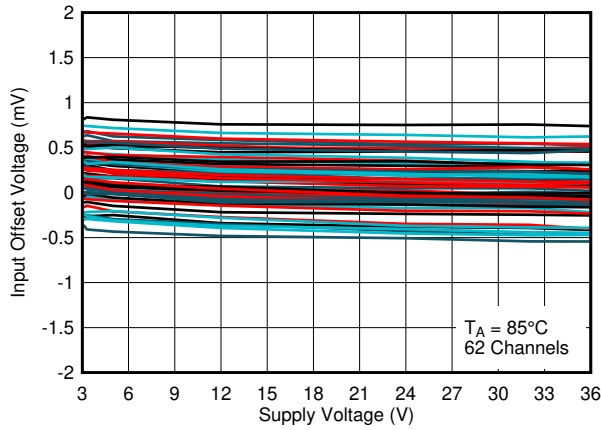

图 7-20. Input Bias Current vs. Supply Voltage

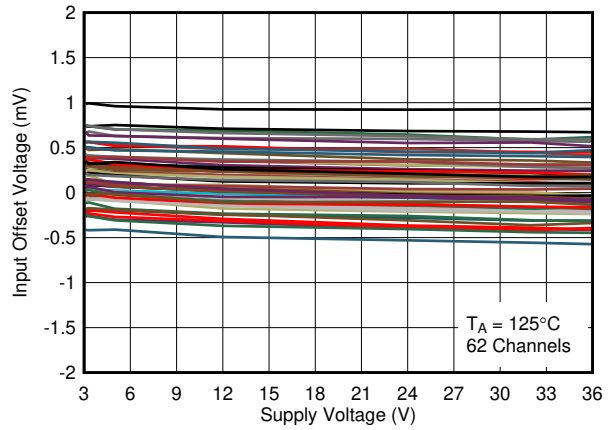

图 7-21. Input Bias Current vs. Input Voltage at 5 V

7.15 Typical Characteristics, LM393B and LM2903B (continued)

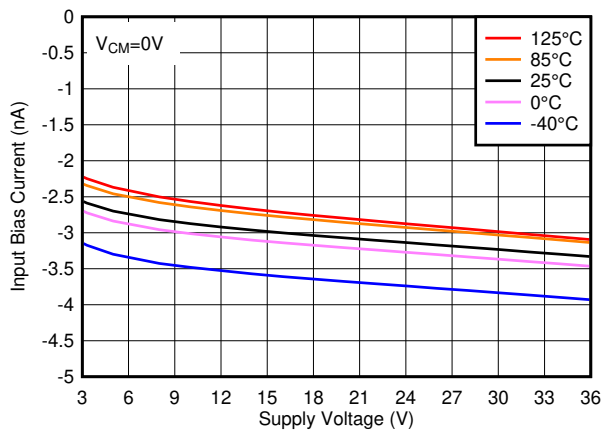
$T_A = 25^\circ\text{C}$, $V_S = 5\text{ V}$, $R_{\text{PULLUP}} = 5.1\text{ k}$, $C_L = 15\text{ pF}$, $V_{\text{CM}} = 0\text{ V}$, $V_{\text{UNDERDRIVE}} = 100\text{ mV}$, $V_{\text{OVERDRIVE}} = 100\text{ mV}$ unless otherwise noted.

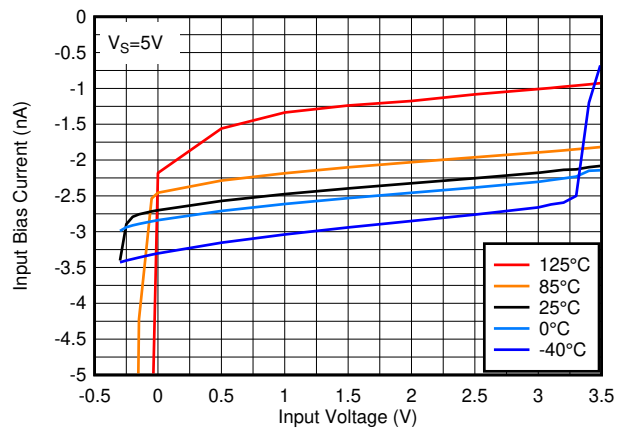

图 7-22. Input Bias Current vs. Input Voltage at 12V



图 7-23. Input Bias Current vs. Input Voltage at 36V

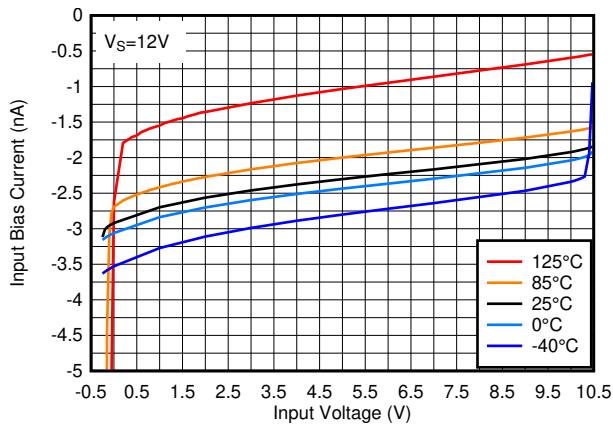

图 7-24. Output Low Voltage vs. Output Sinking Current at 3V

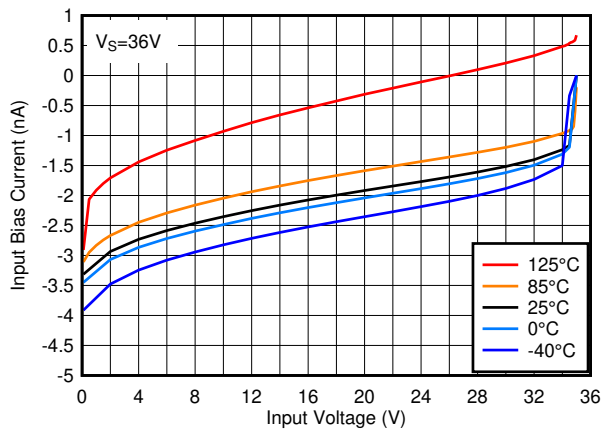

图 7-25. Output Low Voltage vs. Output Sinking Current at 5V

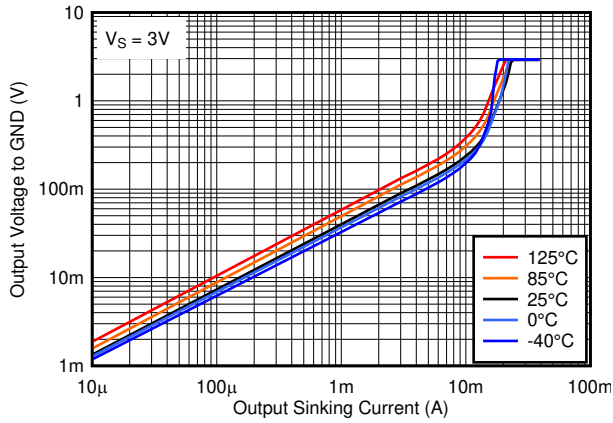

图 7-26. Output Low Voltage vs. Output Sinking Current at 12V

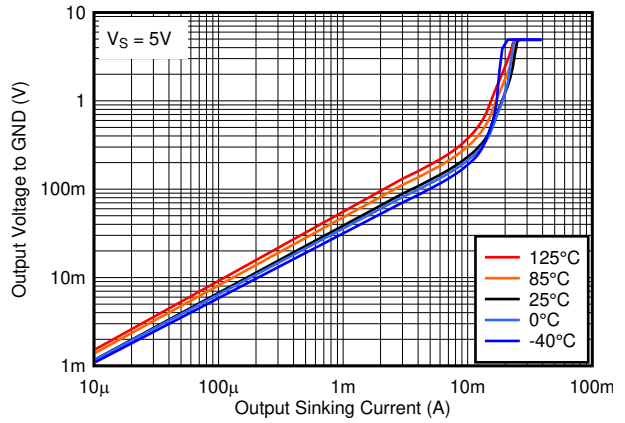

图 7-27. Output Low Voltage vs. Output Sinking Current at 36V

7.15 Typical Characteristics, LM393B and LM2903B (continued)

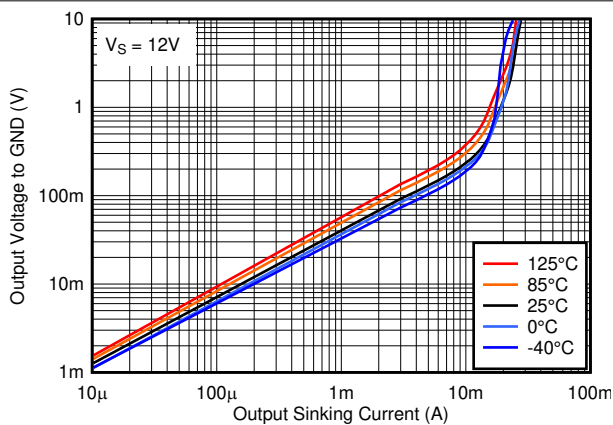
$T_A = 25^\circ\text{C}$, $V_S = 5\text{ V}$, $R_{\text{PULLUP}} = 5.1\text{ k}$, $C_L = 15\text{ pF}$, $V_{\text{CM}} = 0\text{ V}$, $V_{\text{UNDERDRIVE}} = 100\text{ mV}$, $V_{\text{OVERDRIVE}} = 100\text{ mV}$ unless otherwise noted.

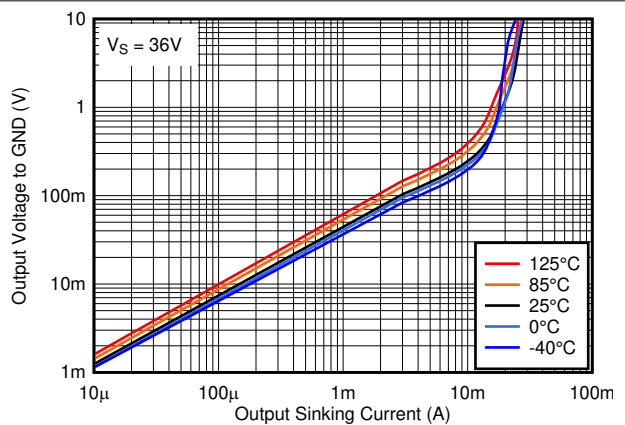

图 7-28. Output High Leakage Current vs. Temperature at 5V



图 7-29. Output High Leakage Current vs. Temperature at 36V

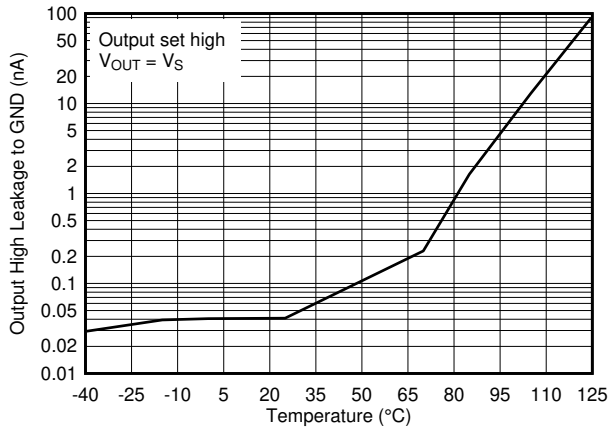

图 7-30. High to Low Propagation Delay vs. Input Overdrive Voltage, 5V

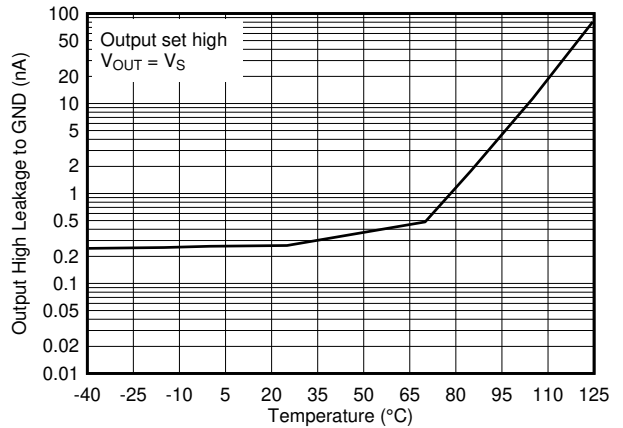

图 7-31. Low to High Propagation Delay vs. Input Overdrive Voltage, 5V

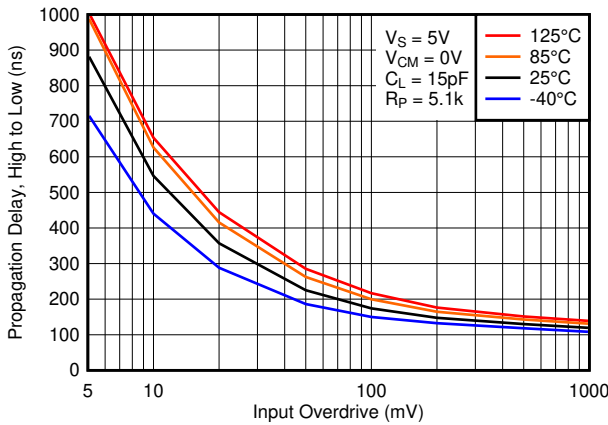

图 7-32. High to Low Propagation Delay vs. Input Overdrive Voltage, 12V

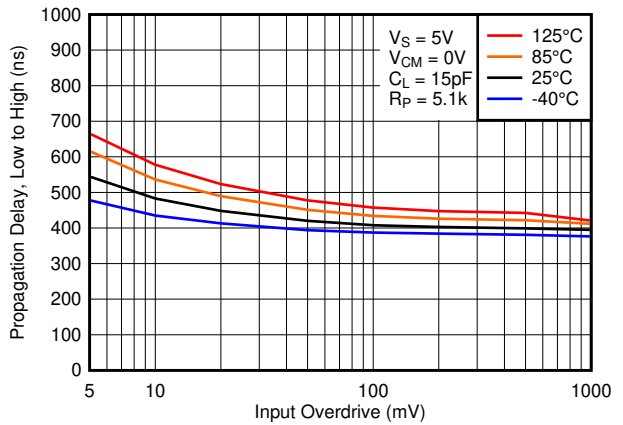

图 7-33. Low to High Propagation Delay vs. Input Overdrive Voltage, 12V

7.15 Typical Characteristics, LM393B and LM2903B (continued)

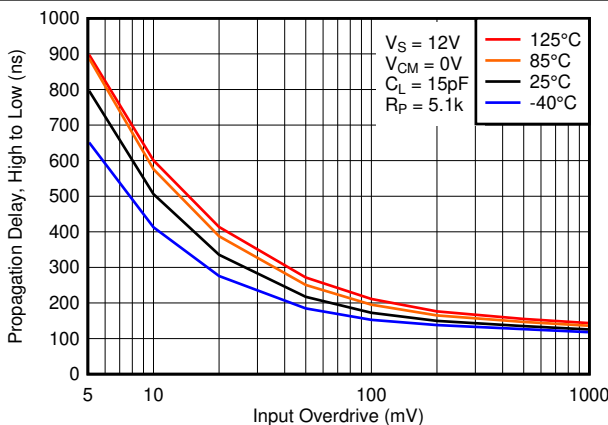
$T_A = 25^\circ\text{C}$, $V_S = 5\text{ V}$, $R_{\text{PULLUP}} = 5.1\text{ k}$, $C_L = 15\text{ pF}$, $V_{\text{CM}} = 0\text{ V}$, $V_{\text{UNDERDRIVE}} = 100\text{ mV}$, $V_{\text{OVERDRIVE}} = 100\text{ mV}$ unless otherwise noted.

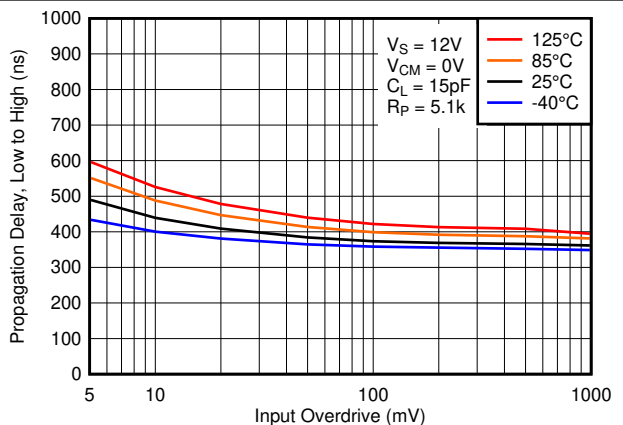

图 7-34. High to Low Propagation Delay vs. Input Overdrive Voltage, 36V



图 7-35. Low to High Propagation Delay vs. Input Overdrive Voltage, 36V

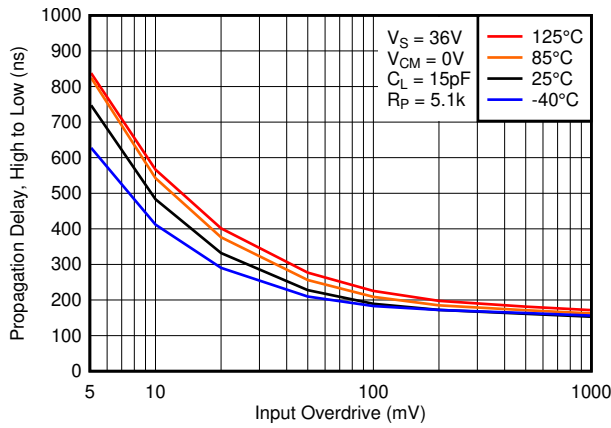

图 7-36. Response Time for Various Overdrives, High-to-Low Transition

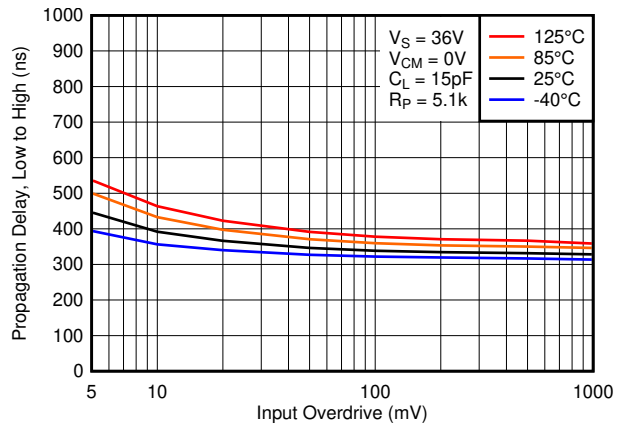

图 7-37. Response Time for Various Overdrives, Low-to-High Transition

8 Detailed Description

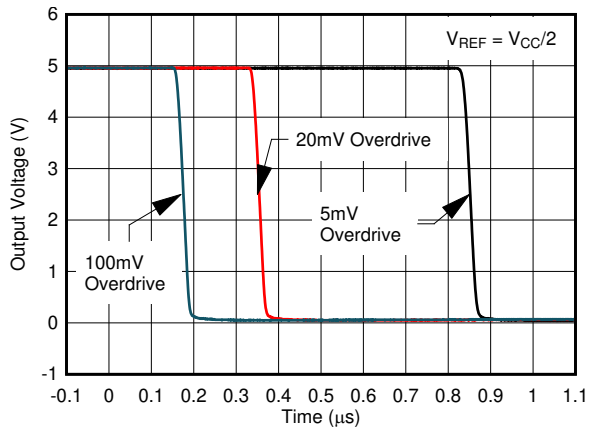
8.1 Overview

These dual comparators have the ability to operate up to absolute maximum of 36 V (38 V for the "B" version) on the supply pin. This device has proven ubiquity and versatility across a wide range of applications. This is due to very wide supply voltages range, low I_q and fast response of the devices.

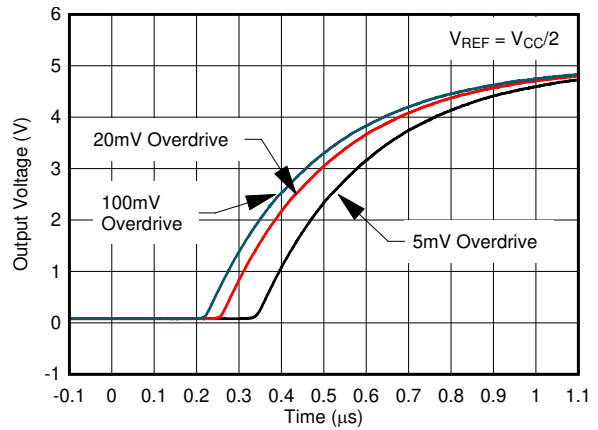
The open-drain output allows the user to configure the output's logic high voltage (V_{OH}) and can be used to enable the comparator to be used in AND functionality.

8.2 Functional Block Diagram



图 8-1. Schematic (Each Comparator)

8.3 Feature Description

The comparator consists of a PNP darlington pair input, allowing the device to operate with very high gain and fast response with minimal input bias current. The input Darlington pair creates a limit on the input common mode voltage capability, allowing the comparator to accurately function from ground to $V_{CC} - 1.5$ V input. Allow for $V_{CC} - 2$ V at cold temperature.

The output consists of an open drain NPN (pull-down or low side) transistor. The output NPN sinks current when the negative input voltage is higher than the positive input voltage and the offset voltage. The V_{OL} is resistive and scales with the output current. See 图 7-3 for V_{OL} values with respect to the output current.

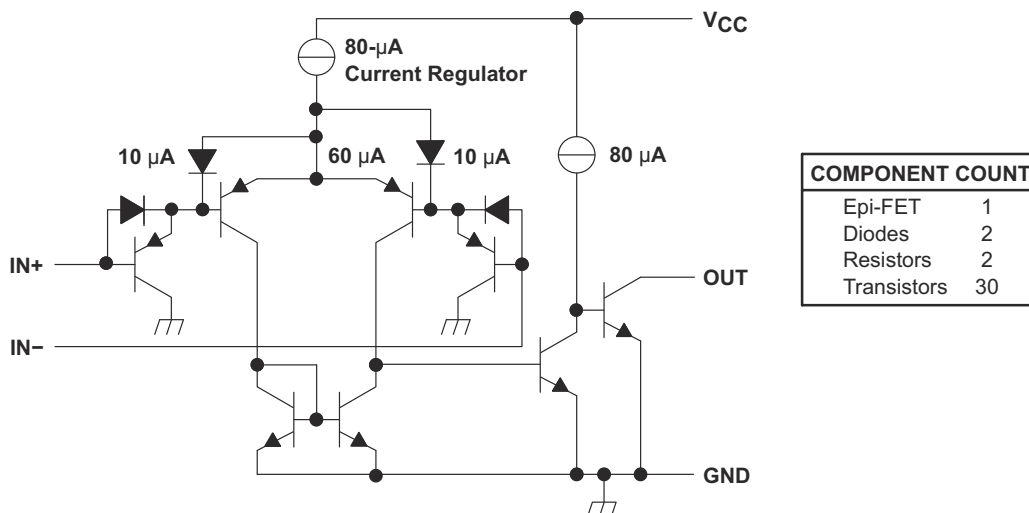
8.4 Device Functional Modes

8.4.1 Voltage Comparison

The device operates solely as a voltage comparator, comparing the differential voltage between the positive and negative pins and outputting a logic low or high impedance (logic high with pullup) based on the input differential polarity.

9 Application and Implementation

Note

Information in the following applications sections is not part of the TI component specification, and TI does not warrant its accuracy or completeness. TI's customers are responsible for determining suitability of components for their purposes. Customers should validate and test their design implementation to confirm system functionality.

9.1 Application Information

The device is typically used to compare a single signal to a reference or two signals against each other. Many users take advantage of the open drain output to drive the comparison logic output to a logic voltage level to an MCU or logic device. The wide supply range and high voltage capability makes this comparator optimal for level shifting to a higher or lower voltage.

9.2 Typical Application



图 9-1. Single-Ended and Differential Comparator Configurations

9.2.1 Design Requirements

For this design example, use the parameters listed in 表 9-1 as the input parameters.

表 9-1. Design Parameters

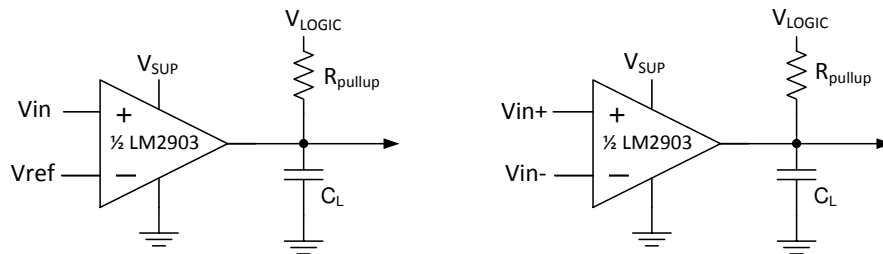
| DESIGN PARAMETER | EXAMPLE VALUE |
|---------------------------------|---------------------------|
| Input Voltage Range | 0 V to $V_{sup}-2$ V |
| Supply Voltage | 4.5 V to V_{CC} maximum |
| Logic Supply Voltage | 0 V to V_{CC} maximum |
| Output Current (R_{PULLUP}) | 1 μ A to 4 mA |
| Input Overdrive Voltage | 100 mV |
| Reference Voltage | 2.5 V |
| Load Capacitance (C_L) | 15 pF |

9.2.2 Detailed Design Procedure

When using the device in a general comparator application, determine the following:

- Input Voltage Range
- Minimum Overdrive Voltage
- Output and Drive Current
- Response Time

9.2.2.1 Input Voltage Range

When choosing the input voltage range, the input common mode voltage range (V_{ICR}) must be taken in to account. If temperature operation is below 25°C the V_{ICR} can range from 0 V to $V_{CC} - 2.0$ V. This limits the input voltage range to as high as $V_{CC} - 2.0$ V and as low as 0 V. Operation outside of this range can yield incorrect comparisons.

The following is a list of input voltage situation and their outcomes:

1. When both IN- and IN+ are both within the common-mode range:
 - a. If IN- is higher than IN+ and the offset voltage, the output is low and the output transistor is sinking current
 - b. If IN- is lower than IN+ and the offset voltage, the output is high impedance and the output transistor is not conducting
2. When IN- is higher than common-mode and IN+ is within common-mode, the output is low and the output transistor is sinking current
3. When IN+ is higher than common-mode and IN- is within common-mode, the output is high impedance and the output transistor is not conducting
4. When IN- and IN+ are both higher than common-mode, the output is low and the output transistor is sinking current

9.2.2.2 Minimum Overdrive Voltage

Overdrive Voltage is the differential voltage produced between the positive and negative inputs of the comparator over the offset voltage (V_{IO}). To make an accurate comparison the Overdrive Voltage (V_{OD}) should be higher than the input offset voltage (V_{IO}). Overdrive voltage can also determine the response time of the comparator, with the response time decreasing with increasing overdrive. 图 9-2 and 图 9-3 show positive and negative response times with respect to overdrive voltage.

9.2.2.3 Output and Drive Current

Output current is determined by the load/pull-up resistance and logic/pullup voltage. The output current produces a output low voltage (V_{OL}) from the comparator. In which V_{OL} is proportional to the output current. Use 节 7.14 to determine V_{OL} based on the output current.

The output current can also effect the transient response. See 节 9.2.2.4 for more information.

9.2.2.4 Response Time

Response time is a function of input over drive. See 节 9.2.3 for typical response times. The rise and falls times can be determined by the load capacitance (C_L), load/pullup resistance (R_{PULLUP}) and equivalent collector-emitter resistance (R_{CE}).

- The rise time (τ_R) is approximately $\tau_R \sim R_{PULLUP} \times C_L$
- The fall time (τ_F) is approximately $\tau_F \sim R_{CE} \times C_L$
 - R_{CE} can be determine by taking the slope of 节 7.14 in its linear region at the desired temperature, or by dividing the V_{OL} by I_{out}

9.2.3 Application Curves

The following curves were generated with 5 V on V_{CC} and V_{Logic} , $R_{PULLUP} = 5.1\text{ k}\Omega$, and 50 pF scope probe.



图 9-2. Response Time for Various Overdrives (Positive Transition)



图 9-3. Response Time for Various Overdrives (Negative Transition)

10 Power Supply Recommendations

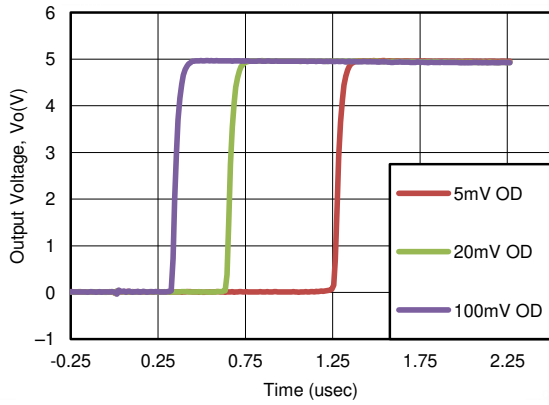
For fast response and comparison applications with noisy or AC inputs, TI recommends to use a bypass capacitor on the supply pin to reject any variation on the supply voltage. This variation can eat into the input common-mode range of the comparator and create an inaccurate comparison.

11 Layout

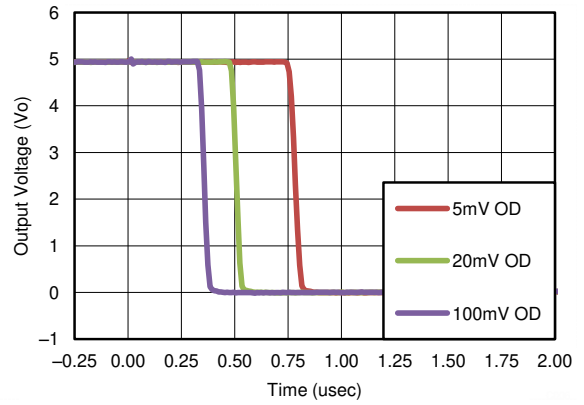
11.1 Layout Guidelines

For accurate comparator applications without hysteresis it is important maintain a stable power supply with minimized noise and glitches. To achieve this, it is best to add a bypass capacitor between the supply voltage and ground. This should be implemented on the positive power supply and negative supply (if available). If a negative supply is not being used, do not put a capacitor between the IC's GND pin and system ground.

Minimize coupling between outputs and inverting inputs to prevent output oscillations. Do not run output and inverting input traces in parallel unless there is a V_{CC} or GND trace between output and inverting input traces to reduce coupling. When series resistance is added to inputs, place resistor close to the device.

11.2 Layout Example



图 11-1. LM2903 Layout Example

12 Device and Documentation Support

12.1 Related Links

The table below lists quick access links. Categories include technical documents, support and community resources, tools and software, and quick access to sample or buy.

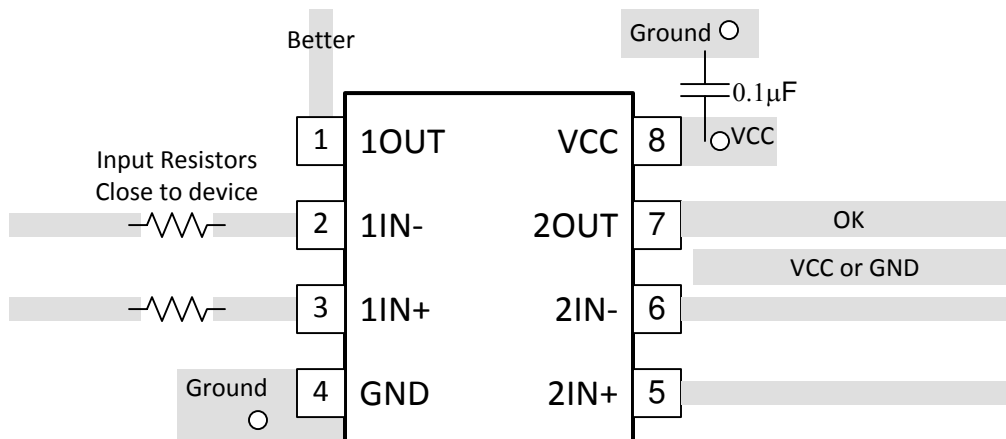
表 12-1. Related Links

| PARTS | PRODUCT FOLDER | SAMPLE & BUY | TECHNICAL DOCUMENTS | TOOLS & SOFTWARE | SUPPORT & COMMUNITY |
|---------|----------------------------|----------------------------|----------------------------|----------------------------|----------------------------|
| LM193 | Click here | Click here | Click here | Click here | Click here |
| LM293 | Click here | Click here | Click here | Click here | Click here |
| LM293A | Click here | Click here | Click here | Click here | Click here |
| LM393 | Click here | Click here | Click here | Click here | Click here |
| LM393A | Click here | Click here | Click here | Click here | Click here |
| LM2903 | Click here | Click here | Click here | Click here | Click here |
| LM2903V | Click here | Click here | Click here | Click here | Click here |
| LM393B | Click here | Click here | Click here | Click here | Click here |
| LM2903B | Click here | Click here | Click here | Click here | Click here |

12.2 Receiving Notification of Documentation Updates

To receive notification of documentation updates, navigate to the device product folder on ti.com. Click on *Subscribe to updates* to register and receive a weekly digest of any product information that has changed. For change details, review the revision history included in any revised document.

12.3 Support Resources

TI E2E™ support forums are an engineer's go-to source for fast, verified answers and design help — straight from the experts. Search existing answers or ask your own question to get the quick design help you need.

Linked content is provided "AS IS" by the respective contributors. They do not constitute TI specifications and do not necessarily reflect TI's views; see TI's [Terms of Use](#).

12.4 Trademarks

TI E2E™ is a trademark of Texas Instruments.

所有商标均为其各自所有者的财产。

12.5 Electrostatic Discharge Caution



This integrated circuit can be damaged by ESD. Texas Instruments recommends that all integrated circuits be handled with appropriate precautions. Failure to observe proper handling and installation procedures can cause damage.

ESD damage can range from subtle performance degradation to complete device failure. Precision integrated circuits may be more susceptible to damage because very small parametric changes could cause the device not to meet its published specifications.

12.6 Glossary

TI Glossary This glossary lists and explains terms, acronyms, and definitions.

13 Mechanical, Packaging, and Orderable Information

The following pages include mechanical, packaging, and orderable information. This information is the most current data available for the designated devices. This data is subject to change without notice and revision of this document. For browser based versions of this data sheet, refer to the left hand navigation.

PACKAGE OPTION ADDENDUM

14-Nov-2021

PACKAGING INFORMATION

| Orderable Device | Status (1) | Package Type | Package Drawing | Pins | Package Qty | Eco Plan (2) | Lead finish/ Ball material (6) | MSL Peak Temp (3) | Op Temp (°C) | Device Marking (4/5) | Samples |
|------------------|---------------|--------------|-----------------|------|-------------|-----------------|--------------------------------------|----------------------|--------------|-------------------------|-------------------------|
| LM193DR | ACTIVE | SOIC | D | 8 | 2500 | RoHS & Green | NIPDAU | Level-1-260C-UNLIM | -55 to 125 | LM193 | Samples |
| LM193DRG4 | ACTIVE | SOIC | D | 8 | 2500 | RoHS & Green | NIPDAU | Level-1-260C-UNLIM | -55 to 125 | LM193 | Samples |
| LM2903AVQDR | ACTIVE | SOIC | D | 8 | 2500 | RoHS & Green | NIPDAU | Level-1-260C-UNLIM | -40 to 125 | L2903AV | Samples |
| LM2903AVQDRG4 | ACTIVE | SOIC | D | 8 | 2500 | RoHS & Green | NIPDAU | Level-1-260C-UNLIM | -40 to 125 | L2903AV | Samples |
| LM2903AVQPWR | ACTIVE | TSSOP | PW | 8 | 2000 | RoHS & Green | NIPDAU | Level-1-260C-UNLIM | -40 to 125 | L2903AV | Samples |
| LM2903AVQPWRG4 | ACTIVE | TSSOP | PW | 8 | 2000 | RoHS & Green | NIPDAU | Level-1-260C-UNLIM | -40 to 125 | L2903AV | Samples |
| LM2903BIDDFR | ACTIVE | SOT-23-THIN | DDF | 8 | 3000 | RoHS & Green | NIPDAU | Level-1-260C-UNLIM | -40 to 125 | 2903B | Samples |
| LM2903BIDGKR | ACTIVE | VSSOP | DGK | 8 | 2500 | RoHS & Green | NIPDAU | Level-1-260C-UNLIM | -40 to 125 | 903B | Samples |
| LM2903BIDR | ACTIVE | SOIC | D | 8 | 2500 | RoHS & Green | NIPDAU | Level-1-260C-UNLIM | -40 to 125 | L2903B | Samples |
| LM2903BIDSGR | ACTIVE | WSON | DSG | 8 | 3000 | RoHS & Green | NIPDAU | Level-1-260C-UNLIM | -40 to 125 | 903B | Samples |
| LM2903BIPWR | ACTIVE | TSSOP | PW | 8 | 2000 | RoHS & Green | NIPDAU | Level-1-260C-UNLIM | -40 to 125 | L2903B | Samples |
| LM2903D | ACTIVE | SOIC | D | 8 | 75 | RoHS & Green | NIPDAU | Level-1-260C-UNLIM | -40 to 125 | LM2903 | Samples |
| LM2903DE4 | ACTIVE | SOIC | D | 8 | 75 | RoHS & Green | NIPDAU | Level-1-260C-UNLIM | -40 to 125 | LM2903 | Samples |
| LM2903DG4 | ACTIVE | SOIC | D | 8 | 75 | RoHS & Green | NIPDAU | Level-1-260C-UNLIM | -40 to 125 | LM2903 | Samples |
| LM2903DGKR | ACTIVE | VSSOP | DGK | 8 | 2500 | RoHS & Green | NIPDAU SN NIPDAUAG | Level-1-260C-UNLIM | -40 to 125 | (MAP, MAS, MAU) | Samples |
| LM2903DGKRG4 | ACTIVE | VSSOP | DGK | 8 | 2500 | RoHS & Green | SN | Level-1-260C-UNLIM | -40 to 125 | (MAP, MAS, MAU) | Samples |
| LM2903DR | ACTIVE | SOIC | D | 8 | 2500 | RoHS & Green | NIPDAU SN | Level-1-260C-UNLIM | -40 to 125 | LM2903 | Samples |
| LM2903DRE4 | ACTIVE | SOIC | D | 8 | 2500 | RoHS & Green | NIPDAU | Level-1-260C-UNLIM | -40 to 125 | LM2903 | Samples |
| LM2903DRG3 | ACTIVE | SOIC | D | 8 | 2500 | RoHS & Green | SN | Level-1-260C-UNLIM | -40 to 125 | LM2903 | Samples |
| LM2903DRG4 | ACTIVE | SOIC | D | 8 | 2500 | RoHS & Green | NIPDAU | Level-1-260C-UNLIM | -40 to 125 | LM2903 | Samples |

PACKAGE OPTION ADDENDUM

14-Nov-2021

| Orderable Device | Status (1) | Package Type | Package Drawing | Pins | Package Qty | Eco Plan (2) | Lead finish/ Ball material (6) | MSL Peak Temp (3) | Op Temp (°C) | Device Marking (4/5) | Samples |
|------------------|---------------|--------------|-----------------|------|-------------|-----------------|--------------------------------------|----------------------|--------------|-------------------------|-------------------------|
| LM2903P | ACTIVE | PDIP | P | 8 | 50 | RoHS & Green | NIPDAU | N / A for Pkg Type | -40 to 125 | LM2903P | Samples |
| LM2903PSR | ACTIVE | SO | PS | 8 | 2000 | RoHS & Green | NIPDAU | Level-1-260C-UNLIM | -40 to 125 | L2903 | Samples |
| LM2903PSRG4 | ACTIVE | SO | PS | 8 | 2000 | RoHS & Green | NIPDAU | Level-1-260C-UNLIM | -40 to 125 | L2903 | Samples |
| LM2903PWR | ACTIVE | TSSOP | PW | 8 | 2000 | RoHS & Green | NIPDAU SN | Level-1-260C-UNLIM | -40 to 125 | L2903 | Samples |
| LM2903PWRG3 | ACTIVE | TSSOP | PW | 8 | 2000 | RoHS & Green | SN | Level-1-260C-UNLIM | -40 to 125 | L2903 | Samples |
| LM2903PWRG4 | ACTIVE | TSSOP | PW | 8 | 2000 | RoHS & Green | NIPDAU | Level-1-260C-UNLIM | -40 to 125 | L2903 | Samples |
| LM2903QD | ACTIVE | SOIC | D | 8 | 75 | RoHS & Green | NIPDAU | Level-1-260C-UNLIM | -40 to 125 | 2903Q | Samples |
| LM2903QDG4 | ACTIVE | SOIC | D | 8 | 75 | RoHS & Green | NIPDAU | Level-1-260C-UNLIM | -40 to 125 | 2903Q | Samples |
| LM2903QDRG4 | ACTIVE | SOIC | D | 8 | 2500 | RoHS & Green | NIPDAU | Level-1-260C-UNLIM | -40 to 125 | 2903Q | Samples |
| LM2903VQDR | ACTIVE | SOIC | D | 8 | 2500 | RoHS & Green | NIPDAU | Level-1-260C-UNLIM | -40 to 125 | L2903V | Samples |
| LM2903VQDRG4 | ACTIVE | SOIC | D | 8 | 2500 | RoHS & Green | NIPDAU | Level-1-260C-UNLIM | -40 to 125 | L2903V | Samples |
| LM2903VQPWR | ACTIVE | TSSOP | PW | 8 | 2000 | RoHS & Green | NIPDAU | Level-1-260C-UNLIM | -40 to 125 | L2903V | Samples |
| LM2903VQPWRG4 | ACTIVE | TSSOP | PW | 8 | 2000 | RoHS & Green | NIPDAU | Level-1-260C-UNLIM | -40 to 125 | L2903V | Samples |
| LM293AD | ACTIVE | SOIC | D | 8 | 75 | RoHS & Green | NIPDAU | Level-1-260C-UNLIM | -25 to 85 | LM293A | Samples |
| LM293ADE4 | ACTIVE | SOIC | D | 8 | 75 | RoHS & Green | NIPDAU | Level-1-260C-UNLIM | -25 to 85 | LM293A | Samples |
| LM293ADGKR | ACTIVE | VSSOP | DGK | 8 | 2500 | RoHS & Green | NIPDAU NIPDAUAG | Level-1-260C-UNLIM | -25 to 85 | (MDP, MDS, MDU) | Samples |
| LM293ADGKRG4 | ACTIVE | VSSOP | DGK | 8 | 2500 | RoHS & Green | NIPDAU | Level-1-260C-UNLIM | -25 to 85 | (MDP, MDS, MDU) | Samples |
| LM293ADR | ACTIVE | SOIC | D | 8 | 2500 | RoHS & Green | NIPDAU SN | Level-1-260C-UNLIM | -25 to 85 | LM293A | Samples |
| LM293ADRG4 | ACTIVE | SOIC | D | 8 | 2500 | RoHS & Green | NIPDAU | Level-1-260C-UNLIM | -25 to 85 | LM293A | Samples |
| LM293D | ACTIVE | SOIC | D | 8 | 75 | RoHS & Green | NIPDAU | Level-1-260C-UNLIM | -25 to 85 | LM293 | Samples |
| LM293DGKR | ACTIVE | VSSOP | DGK | 8 | 2500 | RoHS & Green | NIPDAU SN NIPDAUAG | Level-1-260C-UNLIM | -25 to 85 | (MCP, MCS, MCU) | Samples |

PACKAGE OPTION ADDENDUM

14-Nov-2021

| Orderable Device | Status (1) | Package Type | Package Drawing | Pins | Package Qty | Eco Plan (2) | Lead finish/ Ball material (6) | MSL Peak Temp (3) | Op Temp (°C) | Device Marking (4/5) | Samples |
|------------------|---------------|--------------|-----------------|------|-------------|-----------------|--------------------------------------|----------------------|--------------|-------------------------|-------------------------|
| LM293DGKRG4 | ACTIVE | VSSOP | DGK | 8 | 2500 | RoHS & Green | SN | Level-1-260C-UNLIM | -25 to 85 | (MCP, MCS, MCU) | Samples |
| LM293DR | ACTIVE | SOIC | D | 8 | 2500 | RoHS & Green | NIPDAU SN | Level-1-260C-UNLIM | -25 to 85 | LM293 | Samples |
| LM293DRE4 | ACTIVE | SOIC | D | 8 | 2500 | RoHS & Green | NIPDAU | Level-1-260C-UNLIM | -25 to 85 | LM293 | Samples |
| LM293DRG3 | ACTIVE | SOIC | D | 8 | 2500 | RoHS & Green | SN | Level-1-260C-UNLIM | -25 to 85 | LM293 | Samples |
| LM293DRG4 | ACTIVE | SOIC | D | 8 | 2500 | RoHS & Green | NIPDAU | Level-1-260C-UNLIM | -25 to 85 | LM293 | Samples |
| LM293P | ACTIVE | PDIP | P | 8 | 50 | RoHS & Green | NIPDAU SN | N / A for Pkg Type | -25 to 85 | LM293P | Samples |
| LM293PE4 | ACTIVE | PDIP | P | 8 | 50 | RoHS & Green | NIPDAU | N / A for Pkg Type | -25 to 85 | LM293P | Samples |
| LM393AD | ACTIVE | SOIC | D | 8 | 75 | RoHS & Green | NIPDAU | Level-1-260C-UNLIM | 0 to 70 | LM393A | Samples |
| LM393ADE4 | ACTIVE | SOIC | D | 8 | 75 | RoHS & Green | NIPDAU | Level-1-260C-UNLIM | 0 to 70 | LM393A | Samples |
| LM393ADG4 | ACTIVE | SOIC | D | 8 | 75 | RoHS & Green | NIPDAU | Level-1-260C-UNLIM | 0 to 70 | LM393A | Samples |
| LM393ADGKR | ACTIVE | VSSOP | DGK | 8 | 2500 | RoHS & Green | NIPDAU NIPDAUAG | Level-1-260C-UNLIM | 0 to 70 | (M8P, M8S, M8U) | Samples |
| LM393ADGKRG4 | ACTIVE | VSSOP | DGK | 8 | 2500 | RoHS & Green | NIPDAU | Level-1-260C-UNLIM | 0 to 70 | (M8P, M8S, M8U) | Samples |
| LM393ADR | ACTIVE | SOIC | D | 8 | 2500 | RoHS & Green | NIPDAU SN | Level-1-260C-UNLIM | 0 to 70 | LM393A | Samples |
| LM393ADRE4 | ACTIVE | SOIC | D | 8 | 2500 | RoHS & Green | NIPDAU | Level-1-260C-UNLIM | 0 to 70 | LM393A | Samples |
| LM393ADRG4 | ACTIVE | SOIC | D | 8 | 2500 | RoHS & Green | NIPDAU | Level-1-260C-UNLIM | 0 to 70 | LM393A | Samples |
| LM393AP | ACTIVE | PDIP | P | 8 | 50 | RoHS & Green | NIPDAU SN | N / A for Pkg Type | 0 to 70 | LM393AP | Samples |
| LM393APE4 | ACTIVE | PDIP | P | 8 | 50 | RoHS & Green | NIPDAU | N / A for Pkg Type | 0 to 70 | LM393AP | Samples |
| LM393APSR | ACTIVE | SO | PS | 8 | 2000 | RoHS & Green | NIPDAU | Level-1-260C-UNLIM | 0 to 70 | L393A | Samples |
| LM393APWR | ACTIVE | TSSOP | PW | 8 | 2000 | RoHS & Green | NIPDAU SN | Level-1-260C-UNLIM | 0 to 70 | L393A | Samples |
| LM393APWRE4 | ACTIVE | TSSOP | PW | 8 | 2000 | RoHS & Green | NIPDAU | Level-1-260C-UNLIM | 0 to 70 | L393A | Samples |
| LM393APWRG4 | ACTIVE | TSSOP | PW | 8 | 2000 | RoHS & Green | NIPDAU | Level-1-260C-UNLIM | 0 to 70 | L393A | Samples |

PACKAGE OPTION ADDENDUM

14-Nov-2021

| Orderable Device | Status (1) | Package Type | Package Drawing | Pins | Package Qty | Eco Plan (2) | Lead finish/ Ball material (6) | MSL Peak Temp (3) | Op Temp (°C) | Device Marking (4/5) | Samples |
|------------------|---------------|--------------|-----------------|------|-------------|---------------------|--------------------------------------|----------------------|--------------|-------------------------|-------------------------|
| LM393BIDDFR | ACTIVE | SOT-23-THIN | DDF | 8 | 3000 | RoHS & Green | NIPDAU | Level-1-260C-UNLIM | -40 to 85 | 393B | Samples |
| LM393BIDGKR | ACTIVE | VSSOP | DGK | 8 | 2500 | RoHS & Green | NIPDAU | Level-1-260C-UNLIM | -40 to 85 | 393B | Samples |
| LM393BIDR | ACTIVE | SOIC | D | 8 | 2500 | RoHS & Green | NIPDAU | Level-1-260C-UNLIM | -40 to 85 | LM393B | Samples |
| LM393BIDSGR | ACTIVE | WSON | DSG | 8 | 3000 | RoHS & Green | NIPDAU | Level-1-260C-UNLIM | -40 to 85 | 393B | Samples |
| LM393BIPWR | ACTIVE | TSSOP | PW | 8 | 2000 | RoHS & Green | NIPDAU | Level-1-260C-UNLIM | -40 to 85 | LM393B | Samples |
| LM393D | ACTIVE | SOIC | D | 8 | 75 | RoHS & Green | NIPDAU | Level-1-260C-UNLIM | 0 to 70 | LM393 | Samples |
| LM393DE4 | ACTIVE | SOIC | D | 8 | 75 | RoHS & Green | NIPDAU | Level-1-260C-UNLIM | 0 to 70 | LM393 | Samples |
| LM393DG4 | ACTIVE | SOIC | D | 8 | 75 | RoHS & Green | NIPDAU | Level-1-260C-UNLIM | 0 to 70 | LM393 | Samples |
| LM393DGKR | ACTIVE | VSSOP | DGK | 8 | 2500 | RoHS & Green | NIPDAU SN NIPDAUAG | Level-1-260C-UNLIM | 0 to 70 | (M9P, M9S, M9U) | Samples |
| LM393DGKRG4 | ACTIVE | VSSOP | DGK | 8 | 2500 | RoHS & Green | SN | Level-1-260C-UNLIM | 0 to 70 | (M9P, M9S, M9U) | Samples |
| LM393DR | ACTIVE | SOIC | D | 8 | 2500 | RoHS & Green | NIPDAU SN | Level-1-260C-UNLIM | 0 to 70 | LM393 | Samples |
| LM393DRE4 | ACTIVE | SOIC | D | 8 | 2500 | RoHS & Green | NIPDAU | Level-1-260C-UNLIM | 0 to 70 | LM393 | Samples |
| LM393DRG3 | ACTIVE | SOIC | D | 8 | 2500 | RoHS & Green | SN | Level-1-260C-UNLIM | 0 to 70 | LM393 | Samples |
| LM393DRG4 | ACTIVE | SOIC | D | 8 | 2500 | RoHS & Green | NIPDAU | Level-1-260C-UNLIM | 0 to 70 | LM393 | Samples |
| LM393P | ACTIVE | PDIP | P | 8 | 50 | RoHS & Green | NIPDAU SN | N / A for Pkg Type | 0 to 70 | LM393P | Samples |
| LM393PE3 | ACTIVE | PDIP | P | 8 | 50 | RoHS & Non-Green | SN | N / A for Pkg Type | 0 to 70 | LM393P | Samples |
| LM393PE4 | ACTIVE | PDIP | P | 8 | 50 | RoHS & Green | NIPDAU | N / A for Pkg Type | 0 to 70 | LM393P | Samples |
| LM393PSR | ACTIVE | SO | PS | 8 | 2000 | RoHS & Green | NIPDAU | Level-1-260C-UNLIM | 0 to 70 | L393 | Samples |
| LM393PSRG4 | ACTIVE | SO | PS | 8 | 2000 | RoHS & Green | NIPDAU | Level-1-260C-UNLIM | 0 to 70 | L393 | Samples |
| LM393PW | ACTIVE | TSSOP | PW | 8 | 150 | RoHS & Green | NIPDAU | Level-1-260C-UNLIM | 0 to 70 | L393 | Samples |
| LM393PWG4 | ACTIVE | TSSOP | PW | 8 | 150 | RoHS & Green | NIPDAU | Level-1-260C-UNLIM | 0 to 70 | L393 | Samples |

| Orderable Device | Status (1) | Package Type | Package Drawing | Pins | Package Qty | Eco Plan (2) | Lead finish/ Ball material (6) | MSL Peak Temp (3) | Op Temp (°C) | Device Marking (4/5) | Samples |
|------------------|---------------|--------------|-----------------|------|-------------|-----------------|--------------------------------------|----------------------|--------------|-------------------------|-------------------------|
| LM393PWR | ACTIVE | TSSOP | PW | 8 | 2000 | RoHS & Green | NIPDAU SN | Level-1-260C-UNLIM | 0 to 70 | L393 | Samples |
| LM393PWRG3 | ACTIVE | TSSOP | PW | 8 | 2000 | RoHS & Green | SN | Level-1-260C-UNLIM | 0 to 70 | L393 | Samples |
| LM393PWRG4 | ACTIVE | TSSOP | PW | 8 | 2000 | RoHS & Green | NIPDAU | Level-1-260C-UNLIM | 0 to 70 | L393 | Samples |

(1) The marketing status values are defined as follows:

ACTIVE: Product device recommended for new designs.

LIFEBUY: TI has announced that the device will be discontinued, and a lifetime-buy period is in effect.

NRND: Not recommended for new designs. Device is in production to support existing customers, but TI does not recommend using this part in a new design.

PREVIEW: Device has been announced but is not in production. Samples may or may not be available.

OBSOLETE: TI has discontinued the production of the device.

(2) **RoHS:** TI defines "RoHS" to mean semiconductor products that are compliant with the current EU RoHS requirements for all 10 RoHS substances, including the requirement that RoHS substance do not exceed 0.1% by weight in homogeneous materials. Where designed to be soldered at high temperatures, "RoHS" products are suitable for use in specified lead-free processes. TI may reference these types of products as "Pb-Free".

RoHS Exempt: TI defines "RoHS Exempt" to mean products that contain lead but are compliant with EU RoHS pursuant to a specific EU RoHS exemption.

Green: TI defines "Green" to mean the content of Chlorine (Cl) and Bromine (Br) based flame retardants meet JS709B low halogen requirements of <=1000ppm threshold. Antimony trioxide based flame retardants must also meet the <=1000ppm threshold requirement.

(3) MSL, Peak Temp. - The Moisture Sensitivity Level rating according to the JEDEC industry standard classifications, and peak solder temperature.

(4) There may be additional marking, which relates to the logo, the lot trace code information, or the environmental category on the device.

(5) Multiple Device Markings will be inside parentheses. Only one Device Marking contained in parentheses and separated by a "~" will appear on a device. If a line is indented then it is a continuation of the previous line and the two combined represent the entire Device Marking for that device.

(6) Lead finish/Ball material - Orderable Devices may have multiple material finish options. Finish options are separated by a vertical ruled line. Lead finish/Ball material values may wrap to two lines if the finish value exceeds the maximum column width.

Important Information and Disclaimer:The information provided on this page represents TI's knowledge and belief as of the date that it is provided. TI bases its knowledge and belief on information provided by third parties, and makes no representation or warranty as to the accuracy of such information. Efforts are underway to better integrate information from third parties. TI has taken and continues to take reasonable steps to provide representative and accurate information but may not have conducted destructive testing or chemical analysis on incoming materials and chemicals. TI and TI suppliers consider certain information to be proprietary, and thus CAS numbers and other limited information may not be available for release.

In no event shall TI's liability arising out of such information exceed the total purchase price of the TI part(s) at issue in this document sold by TI to Customer on an annual basis.

OTHER QUALIFIED VERSIONS OF LM2903, LM2903B, LM293 :

- Automotive : [LM2903-Q1](#), [LM2903B-Q1](#)
- Enhanced Product : [LM293-EP](#)

NOTE: Qualified Version Definitions:

- Automotive - Q100 devices qualified for high-reliability automotive applications targeting zero defects
- Enhanced Product - Supports Defense, Aerospace and Medical Applications

TAPE AND REEL INFORMATION

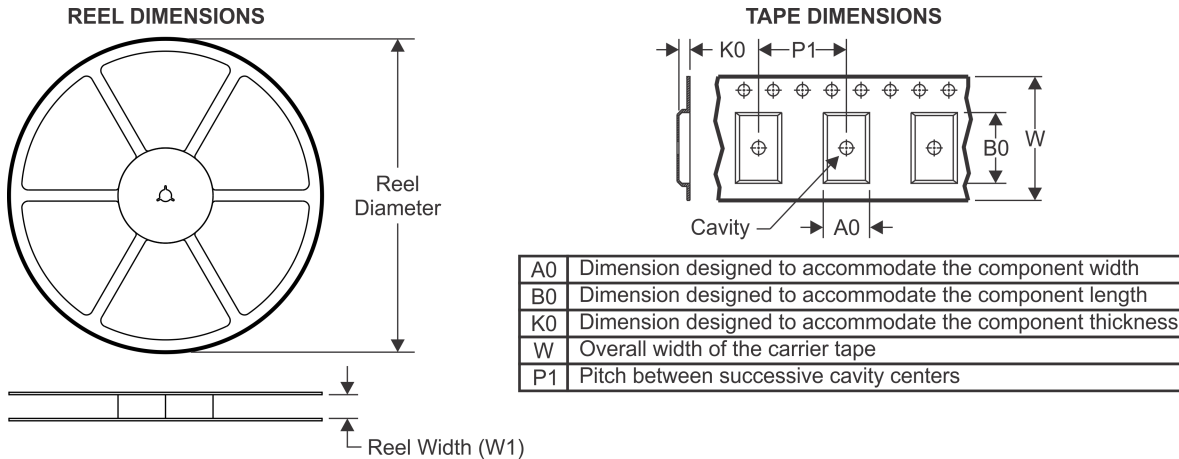

QUADRANT ASSIGNMENTS FOR PIN 1 ORIENTATION IN TAPE

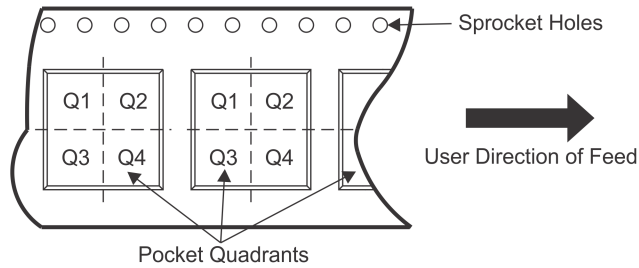

*All dimensions are nominal

| Device | Package Type | Package Drawing | Pins | SPQ | Reel Diameter (mm) | Reel Width W1 (mm) | A0 (mm) | B0 (mm) | K0 (mm) | P1 (mm) | W (mm) | Pin1 Quadrant |
|----------------|--------------|-----------------|------|------|--------------------|--------------------|---------|---------|---------|---------|--------|---------------|
| LM193DR | SOIC | D | 8 | 2500 | 330.0 | 12.4 | 6.4 | 5.2 | 2.1 | 8.0 | 12.0 | Q1 |
| LM2903AVQDR | SOIC | D | 8 | 2500 | 330.0 | 12.5 | 6.4 | 5.2 | 2.1 | 8.0 | 12.0 | Q1 |
| LM2903AVQPWR | TSSOP | PW | 8 | 2000 | 330.0 | 12.4 | 7.0 | 3.6 | 1.6 | 8.0 | 12.0 | Q1 |
| LM2903AVQPWRG4 | TSSOP | PW | 8 | 2000 | 330.0 | 12.4 | 7.0 | 3.6 | 1.6 | 8.0 | 12.0 | Q1 |
| LM2903BIDDFR | SOT-23-THIN | DDF | 8 | 3000 | 180.0 | 8.4 | 3.2 | 3.2 | 1.4 | 4.0 | 8.0 | Q3 |
| LM2903BIDGKR | VSSOP | DGK | 8 | 2500 | 330.0 | 12.4 | 5.3 | 3.4 | 1.4 | 8.0 | 12.0 | Q1 |
| LM2903BIDR | SOIC | D | 8 | 2500 | 330.0 | 12.4 | 6.4 | 5.2 | 2.1 | 8.0 | 12.0 | Q1 |
| LM2903BIDSGR | WSON | DSG | 8 | 3000 | 180.0 | 8.4 | 2.3 | 2.3 | 1.15 | 4.0 | 8.0 | Q2 |
| LM2903BIPWR | TSSOP | PW | 8 | 2000 | 330.0 | 12.4 | 7.0 | 3.6 | 1.6 | 8.0 | 12.0 | Q1 |
| LM2903DGKR | VSSOP | DGK | 8 | 2500 | 330.0 | 12.4 | 5.3 | 3.4 | 1.4 | 8.0 | 12.0 | Q1 |
| LM2903DGKR | VSSOP | DGK | 8 | 2500 | 330.0 | 12.4 | 5.3 | 3.4 | 1.4 | 8.0 | 12.0 | Q1 |
| LM2903DR | SOIC | D | 8 | 2500 | 330.0 | 12.4 | 6.4 | 5.2 | 2.1 | 8.0 | 12.0 | Q1 |
| LM2903DR | SOIC | D | 8 | 2500 | 330.0 | 12.8 | 6.4 | 5.2 | 2.1 | 8.0 | 12.0 | Q1 |
| LM2903DR | SOIC | D | 8 | 2500 | 330.0 | 12.4 | 6.4 | 5.2 | 2.1 | 8.0 | 12.0 | Q1 |
| LM2903DRG3 | SOIC | D | 8 | 2500 | 330.0 | 12.8 | 6.4 | 5.2 | 2.1 | 8.0 | 12.0 | Q1 |
| LM2903DRG4 | SOIC | D | 8 | 2500 | 330.0 | 12.4 | 6.4 | 5.2 | 2.1 | 8.0 | 12.0 | Q1 |
| LM2903DRG4 | SOIC | D | 8 | 2500 | 330.0 | 12.4 | 6.4 | 5.2 | 2.1 | 8.0 | 12.0 | Q1 |

PACKAGE MATERIALS INFORMATION

31-Jul-2021

| Device | Package Type | Package Drawing | Pins | SPQ | Reel Diameter (mm) | Reel Width W1 (mm) | A0 (mm) | B0 (mm) | K0 (mm) | P1 (mm) | W (mm) | Pin1 Quadrant |
|---------------|--------------|-----------------|------|------|--------------------|--------------------|---------|---------|---------|---------|--------|---------------|
| LM2903PSR | SO | PS | 8 | 2000 | 330.0 | 16.4 | 8.35 | 6.6 | 2.4 | 12.0 | 16.0 | Q1 |
| LM2903PWR | TSSOP | PW | 8 | 2000 | 330.0 | 12.4 | 7.0 | 3.6 | 1.6 | 8.0 | 12.0 | Q1 |
| LM2903PWR | TSSOP | PW | 8 | 2000 | 330.0 | 12.4 | 7.0 | 3.6 | 1.6 | 8.0 | 12.0 | Q1 |
| LM2903PWRG3 | TSSOP | PW | 8 | 2000 | 330.0 | 12.4 | 7.0 | 3.6 | 1.6 | 8.0 | 12.0 | Q1 |
| LM2903PWRG4 | TSSOP | PW | 8 | 2000 | 330.0 | 12.4 | 7.0 | 3.6 | 1.6 | 8.0 | 12.0 | Q1 |
| LM2903QDRG4 | SOIC | D | 8 | 2500 | 330.0 | 12.4 | 6.4 | 5.2 | 2.1 | 8.0 | 12.0 | Q1 |
| LM2903VQDR | SOIC | D | 8 | 2500 | 330.0 | 12.5 | 6.4 | 5.2 | 2.1 | 8.0 | 12.0 | Q1 |
| LM2903VQPWR | TSSOP | PW | 8 | 2000 | 330.0 | 12.4 | 7.0 | 3.6 | 1.6 | 8.0 | 12.0 | Q1 |
| LM2903VQPWRG4 | TSSOP | PW | 8 | 2000 | 330.0 | 12.4 | 7.0 | 3.6 | 1.6 | 8.0 | 12.0 | Q1 |
| LM293ADGKR | VSSOP | DGK | 8 | 2500 | 330.0 | 12.4 | 5.3 | 3.4 | 1.4 | 8.0 | 12.0 | Q1 |
| LM293ADR | SOIC | D | 8 | 2500 | 330.0 | 12.4 | 6.4 | 5.2 | 2.1 | 8.0 | 12.0 | Q1 |
| LM293ADR | SOIC | D | 8 | 2500 | 330.0 | 12.8 | 6.4 | 5.2 | 2.1 | 8.0 | 12.0 | Q1 |
| LM293ADR | SOIC | D | 8 | 2500 | 330.0 | 12.4 | 6.4 | 5.2 | 2.1 | 8.0 | 12.0 | Q1 |
| LM293ADRG4 | SOIC | D | 8 | 2500 | 330.0 | 12.4 | 6.4 | 5.2 | 2.1 | 8.0 | 12.0 | Q1 |
| LM293ADRG4 | SOIC | D | 8 | 2500 | 330.0 | 12.4 | 6.4 | 5.2 | 2.1 | 8.0 | 12.0 | Q1 |
| LM293DGKR | VSSOP | DGK | 8 | 2500 | 330.0 | 12.4 | 5.3 | 3.4 | 1.4 | 8.0 | 12.0 | Q1 |
| LM293DGKR | VSSOP | DGK | 8 | 2500 | 330.0 | 12.4 | 5.3 | 3.4 | 1.4 | 8.0 | 12.0 | Q1 |
| LM293DR | SOIC | D | 8 | 2500 | 330.0 | 12.8 | 6.4 | 5.2 | 2.1 | 8.0 | 12.0 | Q1 |
| LM293DR | SOIC | D | 8 | 2500 | 330.0 | 12.4 | 6.4 | 5.2 | 2.1 | 8.0 | 12.0 | Q1 |
| LM293DRG3 | SOIC | D | 8 | 2500 | 330.0 | 12.8 | 6.4 | 5.2 | 2.1 | 8.0 | 12.0 | Q1 |
| LM293DRG4 | SOIC | D | 8 | 2500 | 330.0 | 12.4 | 6.4 | 5.2 | 2.1 | 8.0 | 12.0 | Q1 |
| LM293DRG4 | SOIC | D | 8 | 2500 | 330.0 | 12.4 | 6.4 | 5.2 | 2.1 | 8.0 | 12.0 | Q1 |
| LM393ADGKR | VSSOP | DGK | 8 | 2500 | 330.0 | 12.4 | 5.3 | 3.4 | 1.4 | 8.0 | 12.0 | Q1 |
| LM393ADR | SOIC | D | 8 | 2500 | 330.0 | 12.8 | 6.4 | 5.2 | 2.1 | 8.0 | 12.0 | Q1 |
| LM393ADR | SOIC | D | 8 | 2500 | 330.0 | 12.4 | 6.4 | 5.2 | 2.1 | 8.0 | 12.0 | Q1 |
| LM393ADR | SOIC | D | 8 | 2500 | 330.0 | 12.4 | 6.4 | 5.2 | 2.1 | 8.0 | 12.0 | Q1 |
| LM393ADR | SOIC | D | 8 | 2500 | 330.0 | 15.4 | 6.4 | 5.2 | 2.1 | 8.0 | 12.0 | Q1 |
| LM393ADRG4 | SOIC | D | 8 | 2500 | 330.0 | 12.4 | 6.4 | 5.2 | 2.1 | 8.0 | 12.0 | Q1 |
| LM393ADRG4 | SOIC | D | 8 | 2500 | 330.0 | 12.4 | 6.4 | 5.2 | 2.1 | 8.0 | 12.0 | Q1 |
| LM393APSR | SO | PS | 8 | 2000 | 330.0 | 16.4 | 8.35 | 6.6 | 2.4 | 12.0 | 16.0 | Q1 |
| LM393APWR | TSSOP | PW | 8 | 2000 | 330.0 | 12.4 | 7.0 | 3.6 | 1.6 | 8.0 | 12.0 | Q1 |
| LM393APWR | TSSOP | PW | 8 | 2000 | 330.0 | 12.4 | 7.0 | 3.6 | 1.6 | 8.0 | 12.0 | Q1 |
| LM393APWRG4 | TSSOP | PW | 8 | 2000 | 330.0 | 12.4 | 7.0 | 3.6 | 1.6 | 8.0 | 12.0 | Q1 |
| LM393BIDDFR | SOT-23-THIN | DDF | 8 | 3000 | 180.0 | 8.4 | 3.2 | 3.2 | 1.4 | 4.0 | 8.0 | Q3 |
| LM393BIDGKR | VSSOP | DGK | 8 | 2500 | 330.0 | 12.4 | 5.3 | 3.4 | 1.4 | 8.0 | 12.0 | Q1 |
| LM393BIDR | SOIC | D | 8 | 2500 | 330.0 | 12.4 | 6.4 | 5.2 | 2.1 | 8.0 | 12.0 | Q1 |
| LM393BIDSGR | WSON | DSG | 8 | 3000 | 180.0 | 8.4 | 2.3 | 2.3 | 1.15 | 4.0 | 8.0 | Q2 |
| LM393BIPWR | TSSOP | PW | 8 | 2000 | 330.0 | 12.4 | 7.0 | 3.6 | 1.6 | 8.0 | 12.0 | Q1 |
| LM393DGKR | VSSOP | DGK | 8 | 2500 | 330.0 | 12.4 | 5.3 | 3.4 | 1.4 | 8.0 | 12.0 | Q1 |
| LM393DGKR | VSSOP | DGK | 8 | 2500 | 330.0 | 12.4 | 5.3 | 3.4 | 1.4 | 8.0 | 12.0 | Q1 |
| LM393DR | SOIC | D | 8 | 2500 | 330.0 | 12.4 | 6.4 | 5.2 | 2.1 | 8.0 | 12.0 | Q1 |
| LM393DR | SOIC | D | 8 | 2500 | 330.0 | 12.4 | 6.4 | 5.2 | 2.1 | 8.0 | 12.0 | Q1 |

PACKAGE MATERIALS INFORMATION

31-Jul-2021

| Device | Package Type | Package Drawing | Pins | SPQ | Reel Diameter (mm) | Reel Width W1 (mm) | A0 (mm) | B0 (mm) | K0 (mm) | P1 (mm) | W (mm) | Pin1 Quadrant |
|------------|--------------|-----------------|------|------|--------------------|--------------------|---------|---------|---------|--------------|--------|---------------|
| LM393DRG3 | SOIC | D | 8 | 2500 | 330.0 | 15.4 | 6.4 | 5.2 | 2.1 | 8.0 | 12.0 | Q1 |
| LM393DRG3 | SOIC | D | 8 | 2500 | 330.0 | 12.8 | 6.4 | 5.2 | 2.1 | 8.0 | 12.0 | Q1 |
| LM393DRG4 | SOIC | D | 8 | 2500 | 330.0 | 12.4 | 6.4 | 5.2 | 2.1 | 8.0 | 12.0 | Q1 |
| LM393DRG4 | SOIC | D | 8 | 2500 | 330.0 | 12.4 | 6.4 | 5.2 | 2.1 | 8.0 | 12.0 | Q1 |
| LM393PSR | SO | PS | 8 | 2000 | 330.0 | 16.4 | 8.35 | 6.6 | 2.4 | 12.0 | 16.0 | Q1 |
| LM393PWR | TSSOP | PW | 8 | 2000 | 330.0 | 12.4 | 7.0 | 3.6 | 1.6 | 8.0 | 12.0 | Q1 |
| LM393PWR | TSSOP | PW | 8 | 2000 | 330.0 | 12.4 | 7.0 | 3.6 | 1.6 | 8.0 <td 12.0 | Q1 | |
| LM393PWRG3 | TSSOP | PW | 8 | 2000 | 330.0 | 12.4 | 7.0 | 3.6 | 1.6 | 8.0 | 12.0 | Q1 |
| LM393PWRG4 | TSSOP | PW | 8 | 2000 | 330.0 | 12.4 | 7.0 | 3.6 | 1.6 | 8.0 | 12.0 | Q1 |

TAPE AND REEL BOX DIMENSIONS

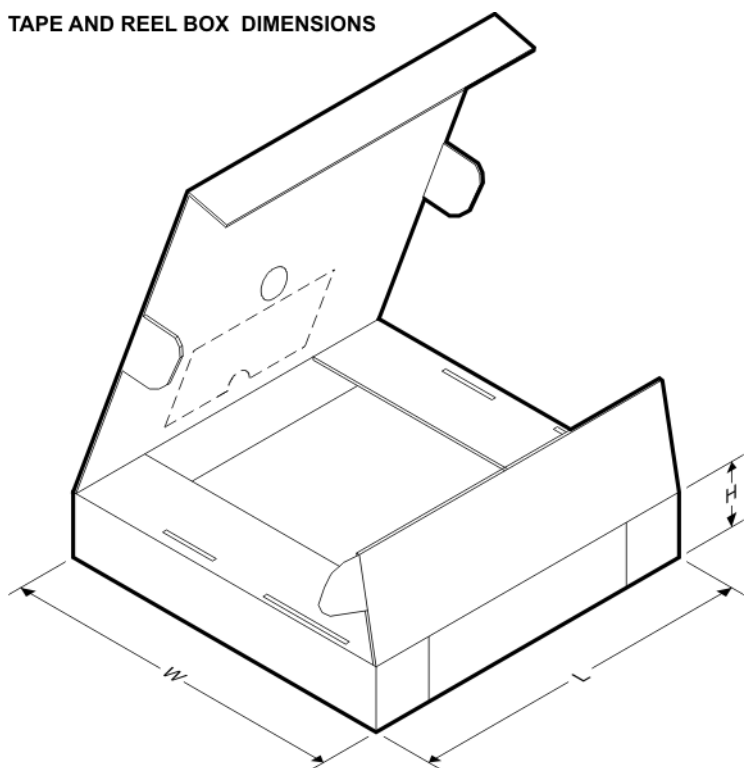

*All dimensions are nominal

| Device | Package Type | Package Drawing | Pins | SPQ | Length (mm) | Width (mm) | Height (mm) |
|----------------|--------------|-----------------|------|------|-------------|------------|-------------|
| LM193DR | SOIC | D | 8 | 2500 | 350.0 | 350.0 | 43.0 |
| LM2903AVQDR | SOIC | D | 8 | 2500 | 340.5 | 336.1 | 25.0 |
| LM2903AVQPWR | TSSOP | PW | 8 | 2000 | 853.0 | 449.0 | 35.0 |
| LM2903AVQPWRG4 | TSSOP | PW | 8 | 2000 | 853.0 | 449.0 | 35.0 |
| LM2903BIDDFR | SOT-23-THIN | DDF | 8 | 3000 | 210.0 | 185.0 | 35.0 |
| LM2903BIDGKR | VSSOP | DGK | 8 | 2500 | 366.0 | 364.0 | 50.0 |
| LM2903BIDR | SOIC | D | 8 | 2500 | 340.5 | 336.1 | 25.0 |
| LM2903BIDSGR | WSON | DSG | 8 | 3000 | 210.0 | 185.0 | 35.0 |

PACKAGE MATERIALS INFORMATION

31-Jul-2021

| Device | Package Type | Package Drawing | Pins | SPQ | Length (mm) | Width (mm) | Height (mm) |
|---------------|--------------|-----------------|------|------|-------------|------------|-------------|
| LM2903BIPWR | TSSOP | PW | 8 | 2000 | 853.0 | 449.0 | 35.0 |
| LM2903DGKR | VSSOP | DGK | 8 | 2500 | 364.0 | 364.0 | 27.0 |
| LM2903DGKR | VSSOP | DGK | 8 | 2500 | 366.0 | 364.0 | 50.0 |
| LM2903DR | SOIC | D | 8 | 2500 | 340.5 | 338.1 | 20.6 |
| LM2903DR | SOIC | D | 8 | 2500 | 364.0 | 364.0 | 27.0 |
| LM2903DR | SOIC | D | 8 | 2500 | 853.0 | 449.0 | 35.0 |
| LM2903DRG3 | SOIC | D | 8 | 2500 | 364.0 | 364.0 | 27.0 |
| LM2903DRG4 | SOIC | D | 8 | 2500 | 853.0 | 449.0 | 35.0 |
| LM2903DRG4 | SOIC | D | 8 | 2500 | 340.5 | 336.1 | 25.0 |
| LM2903PSR | SO | PS | 8 | 2000 | 853.0 | 449.0 | 35.0 |
| LM2903PWR | TSSOP | PW | 8 | 2000 | 853.0 | 449.0 | 35.0 |
| LM2903PWR | TSSOP | PW | 8 | 2000 | 364.0 | 364.0 | 27.0 |
| LM2903PWRG3 | TSSOP | PW | 8 | 2000 | 364.0 | 364.0 | 27.0 |
| LM2903PWRG4 | TSSOP | PW | 8 | 2000 | 853.0 | 449.0 | 35.0 |
| LM2903QDRG4 | SOIC | D | 8 | 2500 | 350.0 | 350.0 | 43.0 |
| LM2903VQDR | SOIC | D | 8 | 2500 | 340.5 | 338.1 | 20.6 |
| LM2903VQPWR | TSSOP | PW | 8 | 2000 | 853.0 | 449.0 | 35.0 |
| LM2903VQPWRG4 | TSSOP | PW | 8 | 2000 | 853.0 | 449.0 | 35.0 |
| LM293ADGKR | VSSOP | DGK | 8 | 2500 | 364.0 | 364.0 | 27.0 |
| LM293ADR | SOIC | D | 8 | 2500 | 853.0 | 449.0 | 35.0 |
| LM293ADR | SOIC | D | 8 | 2500 | 364.0 | 364.0 | 27.0 |
| LM293ADR | SOIC | D | 8 | 2500 | 340.5 | 336.1 | 25.0 |
| LM293ADRG4 | SOIC | D | 8 | 2500 | 853.0 | 449.0 | 35.0 |
| LM293ADRG4 | SOIC | D | 8 | 2500 | 340.5 | 336.1 | 25.0 |
| LM293DGKR | VSSOP | DGK | 8 | 2500 | 366.0 | 364.0 | 50.0 |
| LM293DGKR | VSSOP | DGK | 8 | 2500 | 364.0 | 364.0 | 27.0 |
| LM293DR | SOIC | D | 8 | 2500 | 364.0 | 364.0 | 27.0 |
| LM293DR | SOIC | D | 8 | 2500 | 853.0 | 449.0 | 35.0 |
| LM293DRG3 | SOIC | D | 8 | 2500 | 364.0 | 364.0 | 27.0 |
| LM293DRG4 | SOIC | D | 8 | 2500 | 853.0 | 449.0 | 35.0 |
| LM293DRG4 | SOIC | D | 8 | 2500 | 340.5 | 336.1 | 25.0 |
| LM393ADGKR | VSSOP | DGK | 8 | 2500 | 364.0 | 364.0 | 27.0 |
| LM393ADR | SOIC | D | 8 | 2500 | 364.0 | 364.0 | 27.0 |
| LM393ADR | SOIC | D | 8 | 2500 | 853.0 | 449.0 | 35.0 |
| LM393ADR | SOIC | D | 8 | 2500 | 340.5 | 336.1 | 25.0 |
| LM393ADR | SOIC | D | 8 | 2500 | 333.2 | 345.9 | 28.6 |
| LM393ADRG4 | SOIC | D | 8 | 2500 | 853.0 | 449.0 | 35.0 |
| LM393ADRG4 | SOIC | D | 8 | 2500 | 340.5 | 336.1 | 25.0 |
| LM393APSR | SO | PS | 8 | 2000 | 853.0 | 449.0 | 35.0 |
| LM393APWR | TSSOP | PW | 8 | 2000 | 853.0 | 449.0 | 35.0 |
| LM393APWR | TSSOP | PW | 8 | 2000 | 364.0 | 364.0 | 27.0 |
| LM393APWRG4 | TSSOP | PW | 8 | 2000 | 853.0 | 449.0 | 35.0 |
| LM393BIDDFR | SOT-23-THIN | DDF | 8 | 3000 | 210.0 | 185.0 | 35.0 |
| LM393BIDGKR | VSSOP | DGK | 8 | 2500 | 366.0 | 364.0 | 50.0 |

PACKAGE MATERIALS INFORMATION

31-Jul-2021

| Device | Package Type | Package Drawing | Pins | SPQ | Length (mm) | Width (mm) | Height (mm) |
|-------------|--------------|-----------------|------|------|-------------|------------|-------------|
| LM393BIDR | SOIC | D | 8 | 2500 | 340.5 | 336.1 | 25.0 |
| LM393BIDSGR | WSON | DSG | 8 | 3000 | 210.0 | 185.0 | 35.0 |
| LM393BIPWR | TSSOP | PW | 8 | 2000 | 853.0 | 449.0 | 35.0 |
| LM393DGKR | VSSOP | DGK | 8 | 2500 | 364.0 | 364.0 | 27.0 |
| LM393DGKR | VSSOP | DGK | 8 | 2500 | 366.0 | 364.0 | 50.0 |
| LM393DR | SOIC | D | 8 | 2500 | 853.0 | 449.0 | 35.0 |
| LM393DR | SOIC | D | 8 | 2500 | 340.5 | 338.1 | 25.0 |
| LM393DRG3 | SOIC | D | 8 | 2500 | 333.2 | 345.9 | 28.6 |
| LM393DRG3 | SOIC | D | 8 | 2500 | 364.0 | 364.0 | 27.0 |
| LM393DRG4 | SOIC | D | 8 | 2500 | 853.0 | 449.0 | 35.0 |
| LM393DRG4 | SOIC | D | 8 | 2500 | 340.5 | 336.1 | 25.0 |
| LM393PSR | SO | PS | 8 | 2000 | 853.0 | 449.0 | 35.0 |
| LM393PWR | TSSOP | PW | 8 | 2000 | 364.0 | 364.0 | 27.0 |
| LM393PWR | TSSOP | PW | 8 | 2000 | 853.0 | 449.0 | 35.0 |
| LM393PWRG3 | TSSOP | PW | 8 | 2000 | 364.0 | 364.0 | 27.0 |
| LM393PWRG4 | TSSOP | PW | 8 | 2000 | 853.0 | 449.0 | 35.0 |

DDF0008A

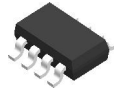

PACKAGE OUTLINE

SOT-23 - 1.1 mm max height

PLASTIC SMALL OUTLINE

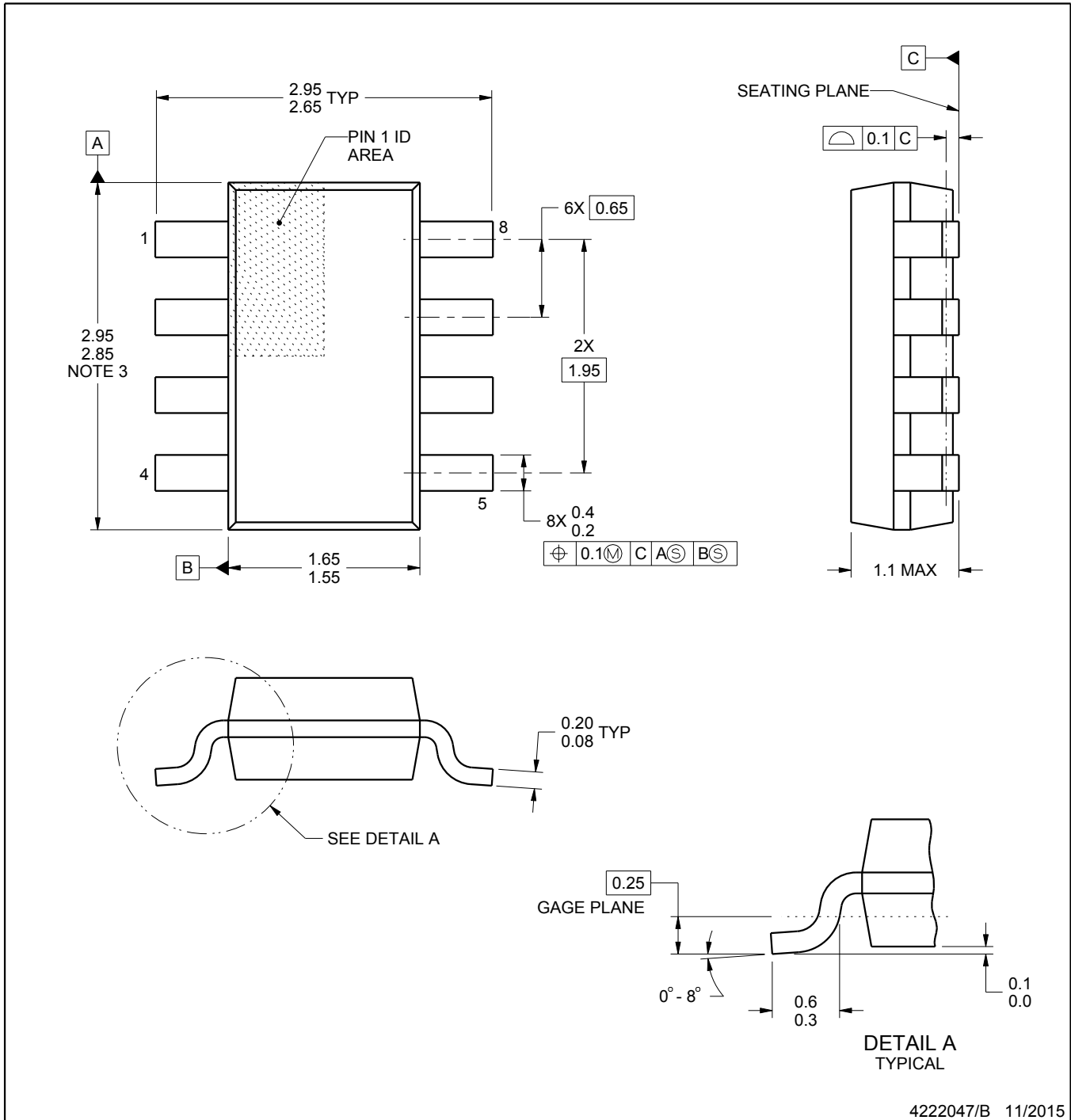

4222047/B 11/2015

NOTES:

1. All linear dimensions are in millimeters. Any dimensions in parenthesis are for reference only. Dimensioning and tolerancing per ASME Y14.5M.
2. This drawing is subject to change without notice.
3. This dimension does not include mold flash, protrusions, or gate burrs. Mold flash, protrusions, or gate burrs shall not exceed 0.15 mm per side.

EXAMPLE BOARD LAYOUT

DDF0008A

SOT-23 - 1.1 mm max height

PLASTIC SMALL OUTLINE

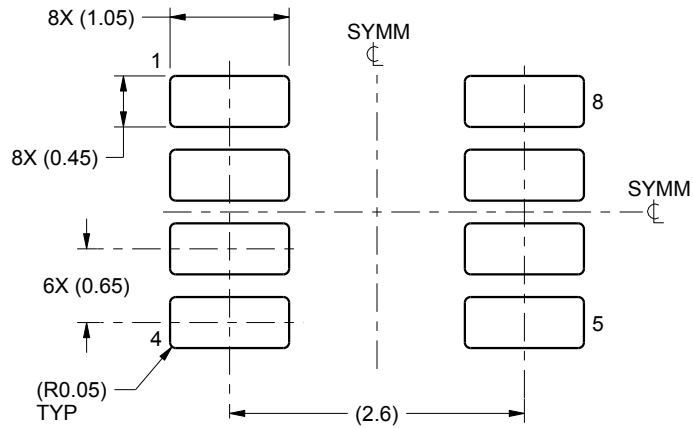

LAND PATTERN EXAMPLE
SCALE:15X

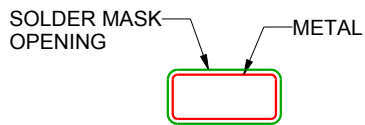

NON SOLDER MASK
DEFINED

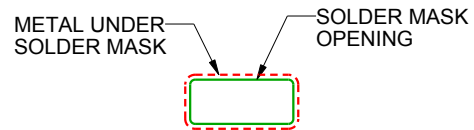

SOLDER MASK
DEFINED

SOLDER MASK DETAILS

4222047/B 11/2015

NOTES: (continued)

4. Publication IPC-7351 may have alternate designs.
5. Solder mask tolerances between and around signal pads can vary based on board fabrication site.

EXAMPLE STENCIL DESIGN

DDF0008A

SOT-23 - 1.1 mm max height

PLASTIC SMALL OUTLINE

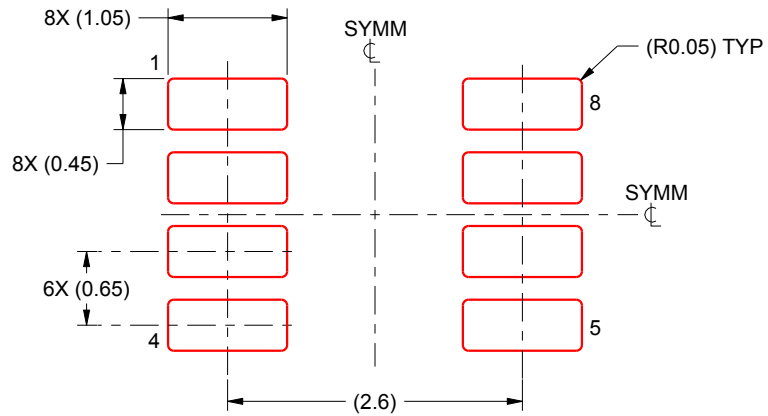

SOLDER PASTE EXAMPLE
BASED ON 0.125 mm THICK STENCIL
SCALE:15X

4222047/B 11/2015

NOTES: (continued)

6. Laser cutting apertures with trapezoidal walls and rounded corners may offer better paste release. IPC-7525 may have alternate design recommendations.
7. Board assembly site may have different recommendations for stencil design.



D0008A

PACKAGE OUTLINE

SOIC - 1.75 mm max height

SMALL OUTLINE INTEGRATED CIRCUIT

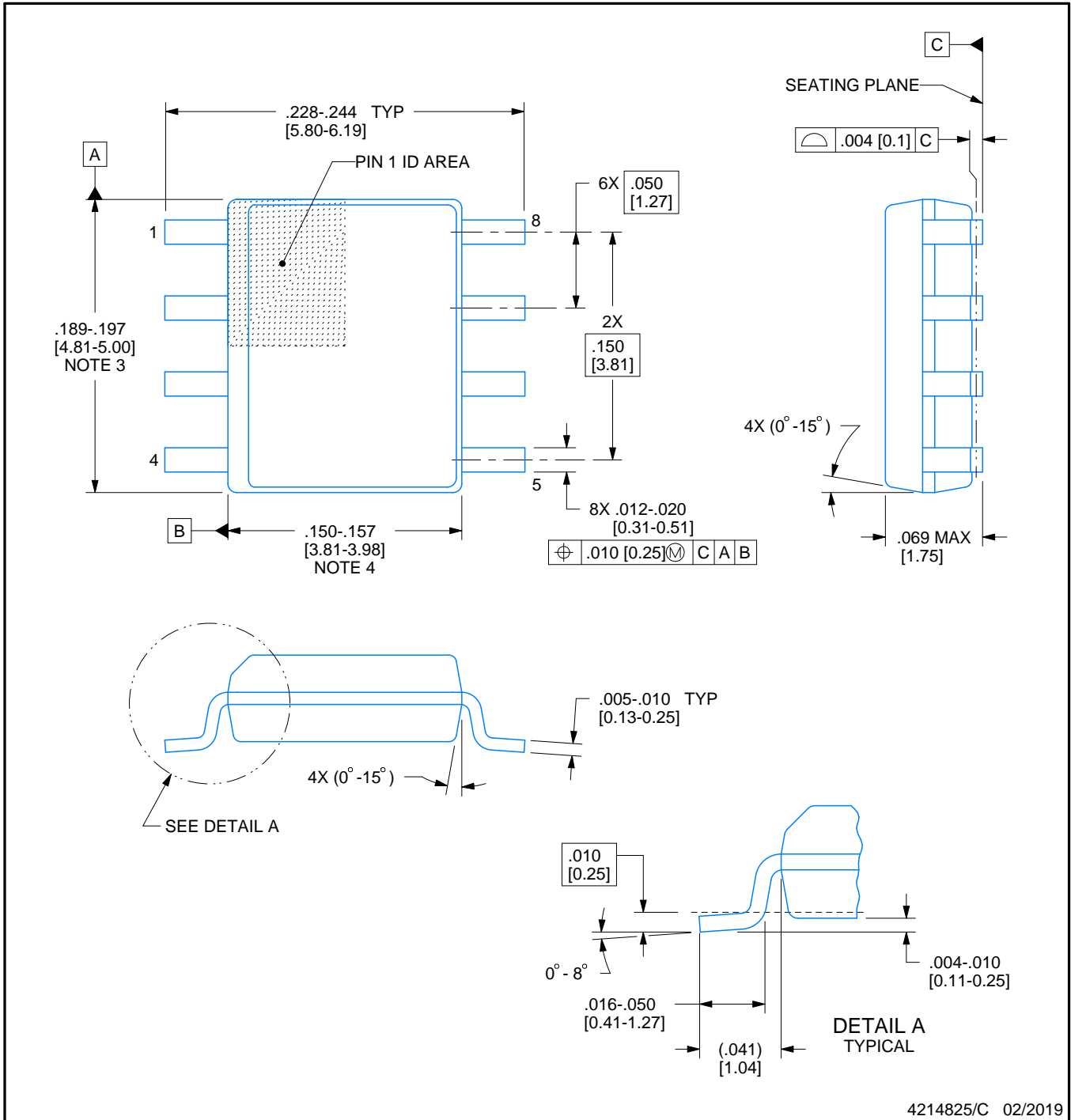

4214825/C 02/2019

NOTES:

1. Linear dimensions are in inches [millimeters]. Dimensions in parenthesis are for reference only. Controlling dimensions are in inches. Dimensioning and tolerancing per ASME Y14.5M.
2. This drawing is subject to change without notice.
3. This dimension does not include mold flash, protrusions, or gate burrs. Mold flash, protrusions, or gate burrs shall not exceed .006 [0.15] per side.
4. This dimension does not include interlead flash.
5. Reference JEDEC registration MS-012, variation AA.

EXAMPLE BOARD LAYOUT

D0008A

SOIC - 1.75 mm max height

SMALL OUTLINE INTEGRATED CIRCUIT



LAND PATTERN EXAMPLE
EXPOSED METAL SHOWN
SCALE:8X



SOLDER MASK DETAILS

4214825/C 02/2019

NOTES: (continued)

- 6. Publication IPC-7351 may have alternate designs.
- 7. Solder mask tolerances between and around signal pads can vary based on board fabrication site.

EXAMPLE STENCIL DESIGN

D0008A

SOIC - 1.75 mm max height

SMALL OUTLINE INTEGRATED CIRCUIT

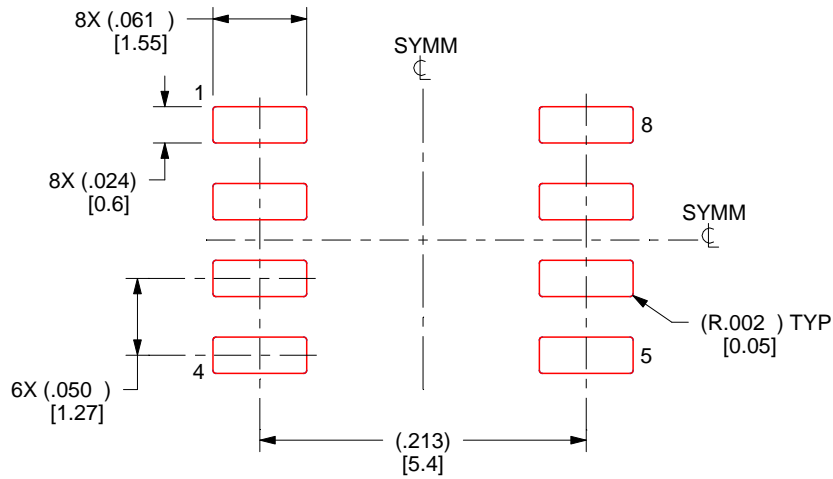

SOLDER PASTE EXAMPLE
BASED ON .005 INCH [0.125 MM] THICK STENCIL
SCALE:8X

4214825/C 02/2019

NOTES: (continued)

8. Laser cutting apertures with trapezoidal walls and rounded corners may offer better paste release. IPC-7525 may have alternate design recommendations.
9. Board assembly site may have different recommendations for stencil design.

MECHANICAL DATA

PS (R-PDSO-G8)

PLASTIC SMALL-OUTLINE PACKAGE

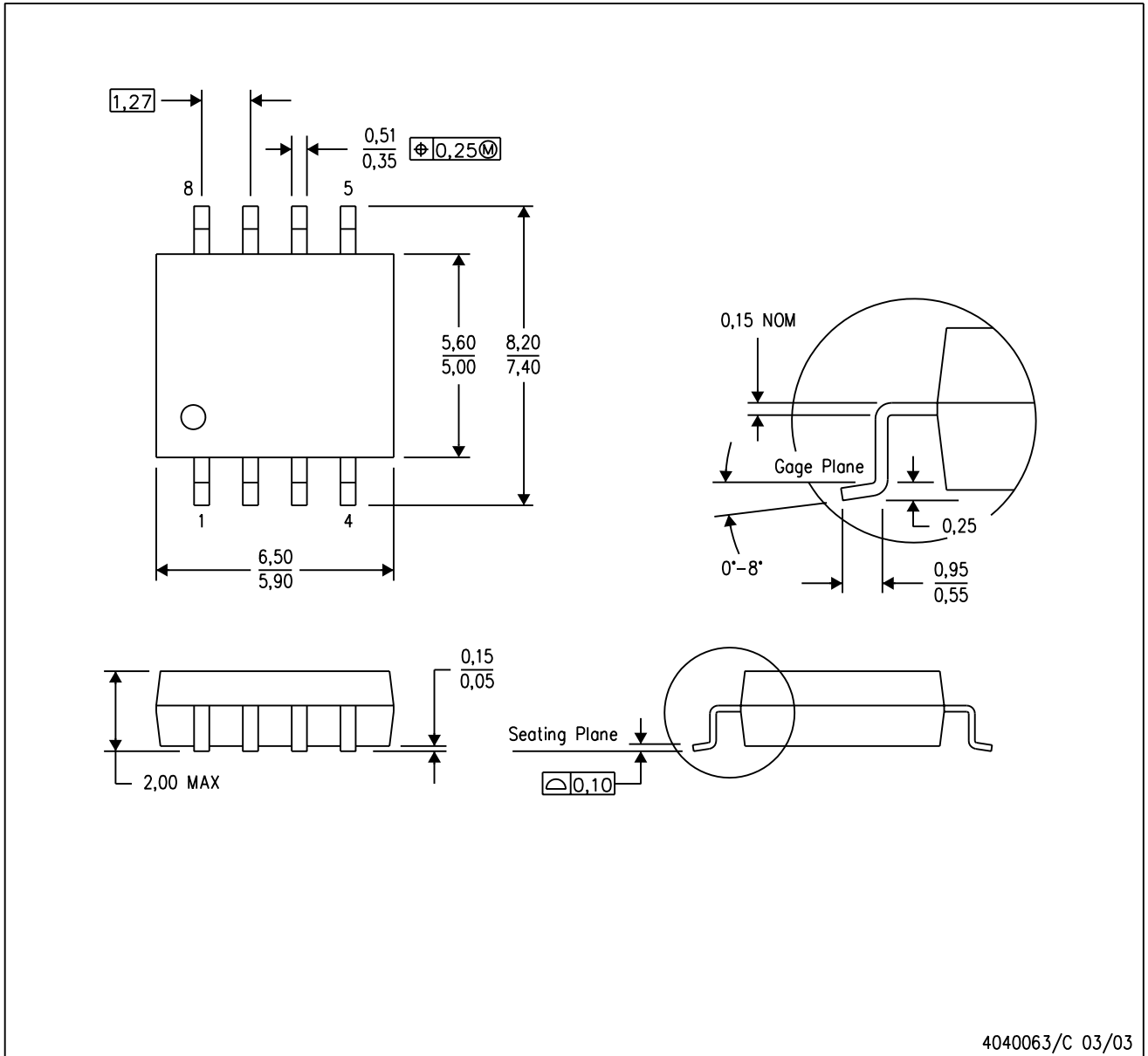

4040063/C 03/03

- NOTES:
- A. All linear dimensions are in millimeters.
 - B. This drawing is subject to change without notice.
 - C. Body dimensions do not include mold flash or protrusion, not to exceed 0,15.

PS (R-PDSO-G8)

PLASTIC SMALL OUTLINE

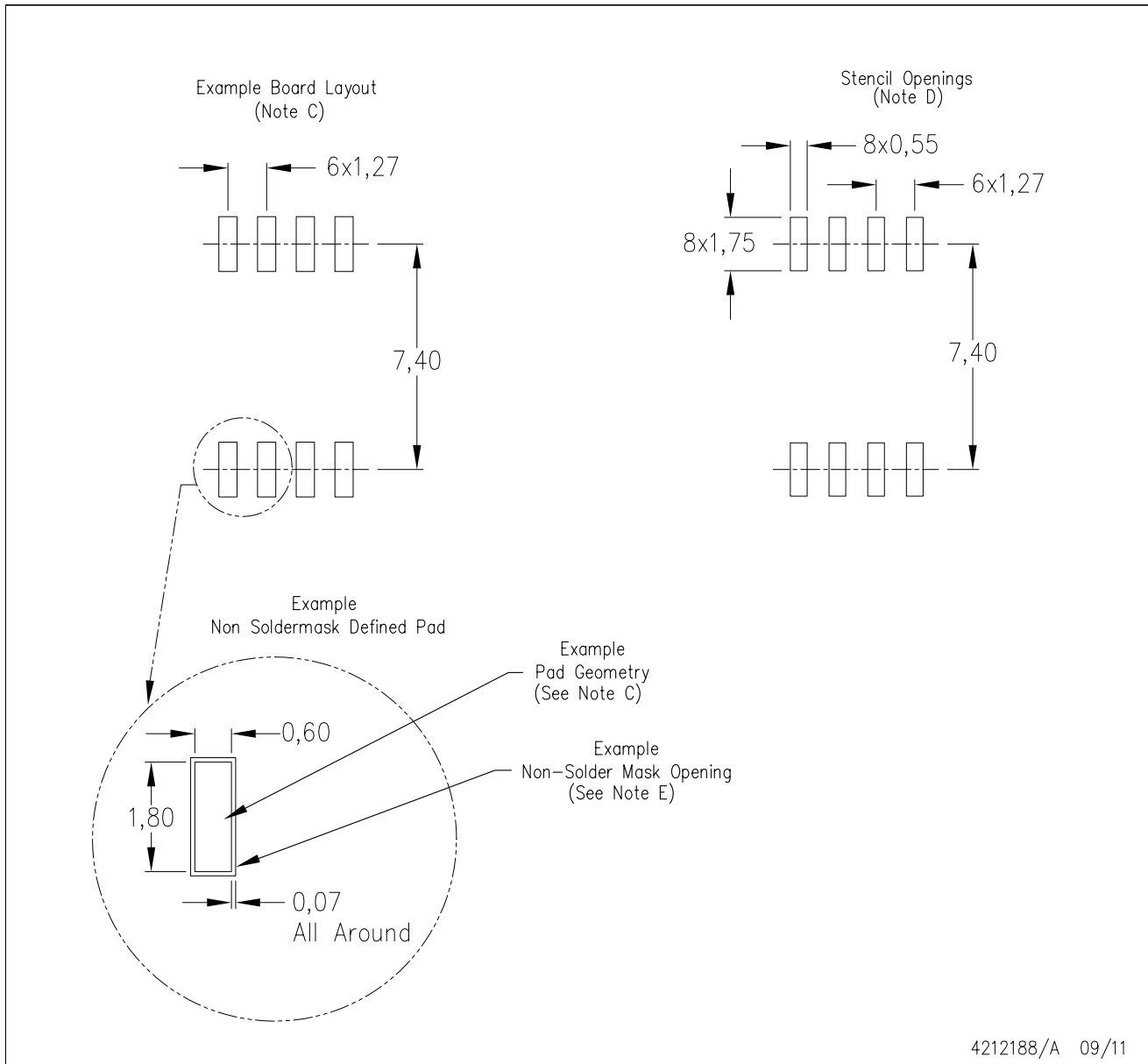

- NOTES:
- All linear dimensions are in millimeters.
 - This drawing is subject to change without notice.
 - Publication IPC-7351 is recommended for alternate designs.
 - Laser cutting apertures with trapezoidal walls and also rounding corners will offer better paste release. Customers should contact their board assembly site for stencil design recommendations. Refer to IPC-7525 for other stencil recommendations.
 - Customers should contact their board fabrication site for solder mask tolerances between and around signal pads.

MECHANICAL DATA

P (R-PDIP-T8)

PLASTIC DUAL-IN-LINE PACKAGE

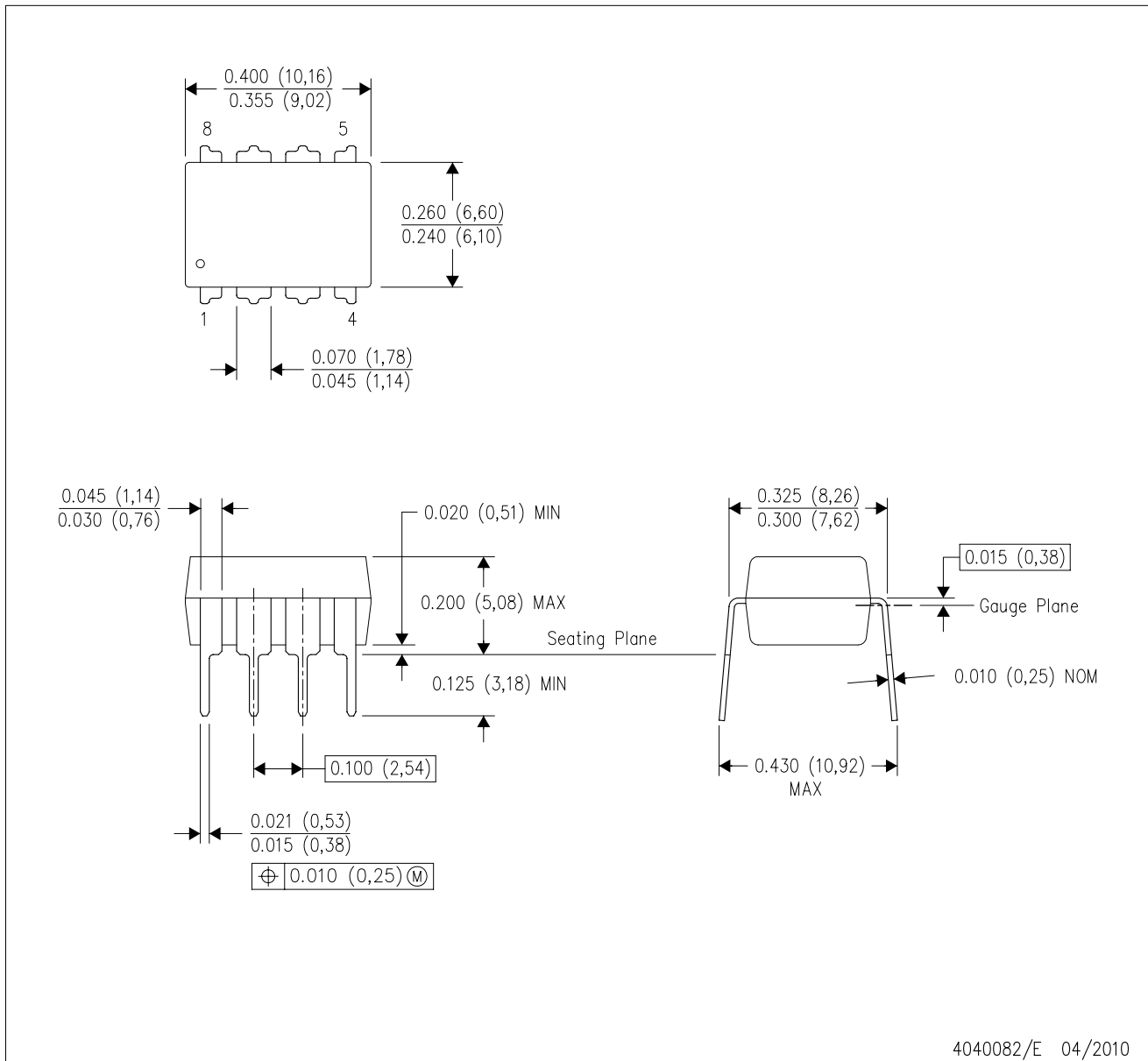

4040082/E 04/2010

- NOTES:
- All linear dimensions are in inches (millimeters).
 - This drawing is subject to change without notice.
 - Falls within JEDEC MS-001 variation BA.

DGK (S-PDSO-G8)

PLASTIC SMALL-OUTLINE PACKAGE

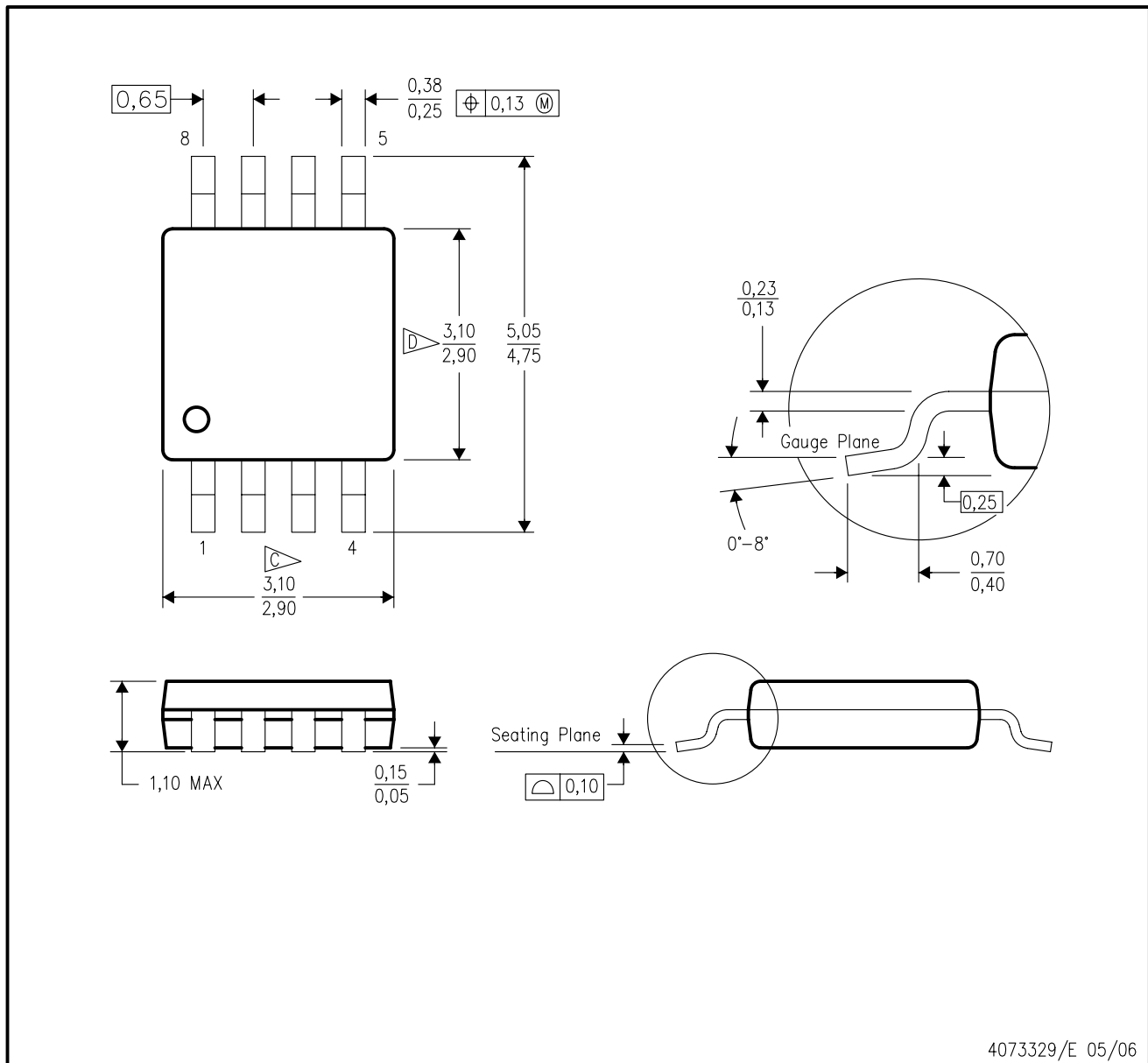

- NOTES:
- A. All linear dimensions are in millimeters.
 - B. This drawing is subject to change without notice.
 - C. Body length does not include mold flash, protrusions, or gate burrs. Mold flash, protrusions, or gate burrs shall not exceed 0.15 per end.
 - D. Body width does not include interlead flash. Interlead flash shall not exceed 0.50 per side.
 - E. Falls within JEDEC MO-187 variation AA, except interlead flash.

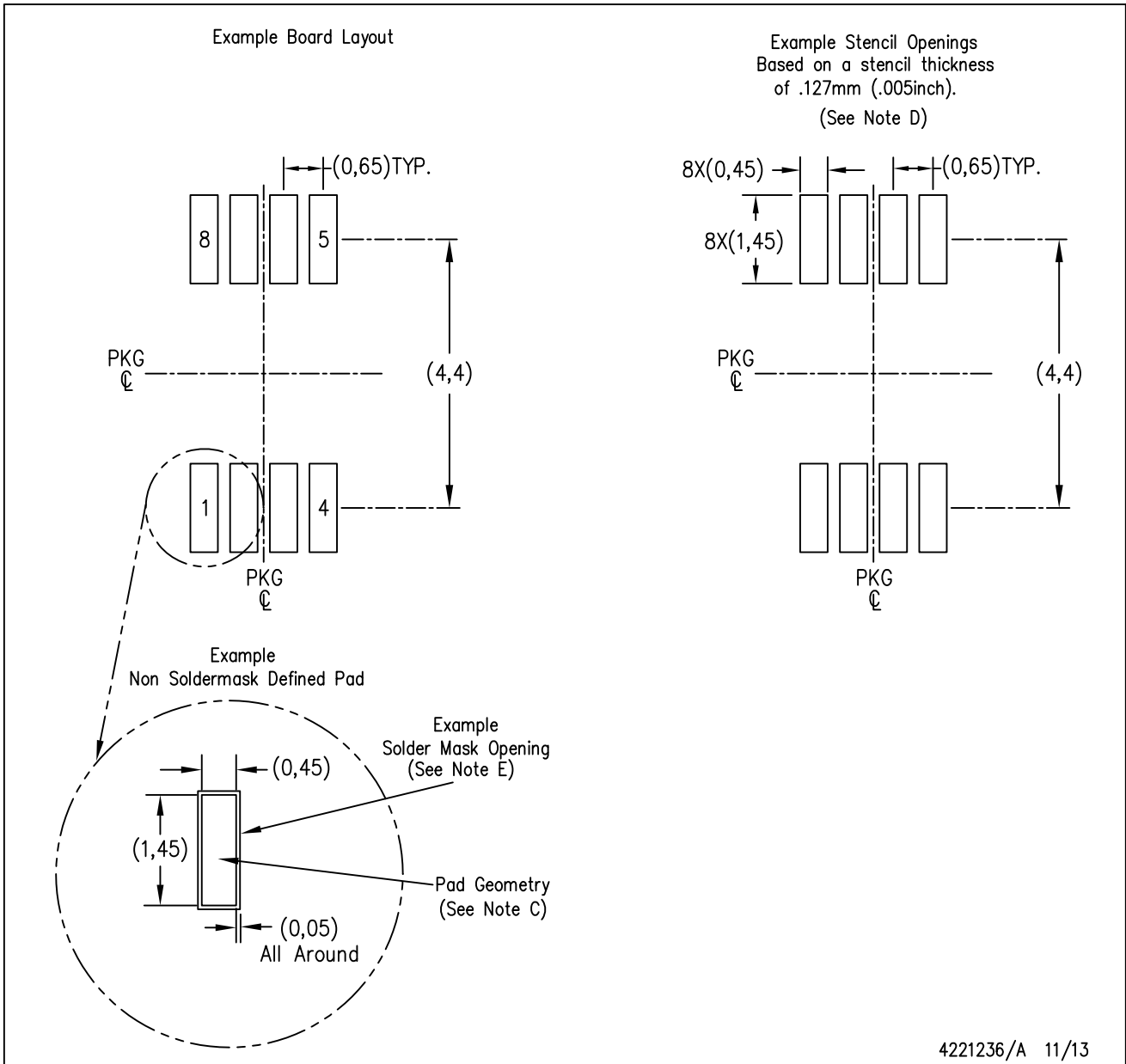

- NOTES:
- A. All linear dimensions are in millimeters.
 - B. This drawing is subject to change without notice.
 - C. Publication IPC-7351 is recommended for alternate designs.
 - D. Laser cutting apertures with trapezoidal walls and also rounding corners will offer better paste release. Customers should contact their board assembly site for stencil design recommendations. Refer to IPC-7525 for other stencil recommendations.
 - E. Customers should contact their board fabrication site for solder mask tolerances between and around signal pads.

GENERIC PACKAGE VIEW

DSG 8

WSON - 0.8 mm max height

2 x 2, 0.5 mm pitch

PLASTIC SMALL OUTLINE - NO LEAD

This image is a representation of the package family, actual package may vary.
Refer to the product data sheet for package details.



DSG0008A

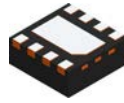

PACKAGE OUTLINE

WSON - 0.8 mm max height

PLASTIC SMALL OUTLINE - NO LEAD

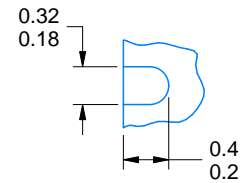

ALTERNATIVE TERMINAL SHAPE
TYPICAL

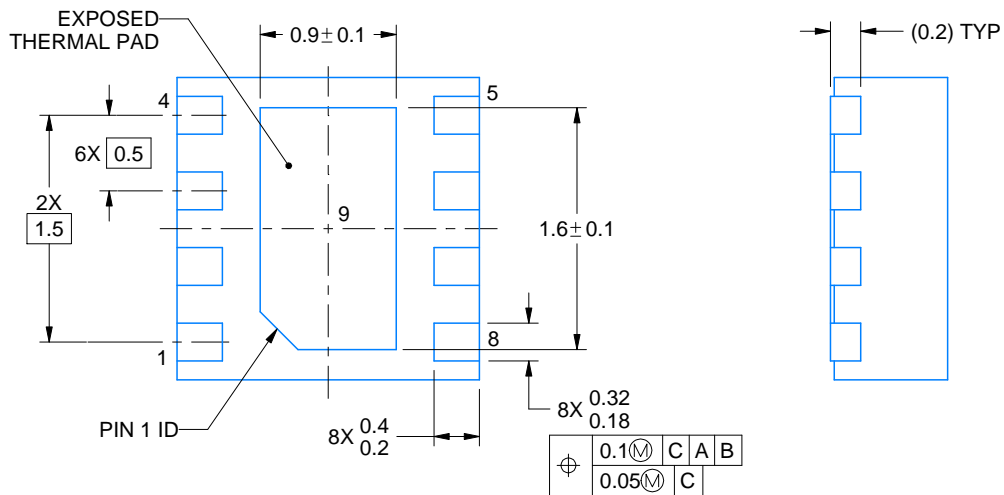
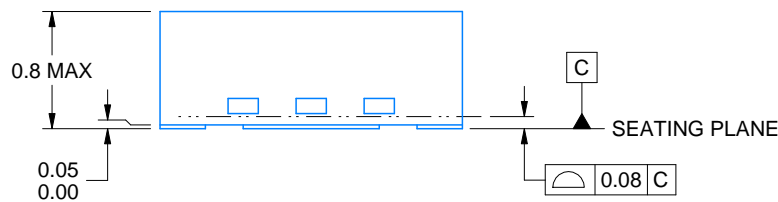

4218900/D 04/2020

NOTES:

1. All linear dimensions are in millimeters. Any dimensions in parenthesis are for reference only. Dimensioning and tolerancing per ASME Y14.5M.
2. This drawing is subject to change without notice.
3. The package thermal pad must be soldered to the printed circuit board for thermal and mechanical performance.

EXAMPLE BOARD LAYOUT

DSG0008A

WSON - 0.8 mm max height

PLASTIC SMALL OUTLINE - NO LEAD

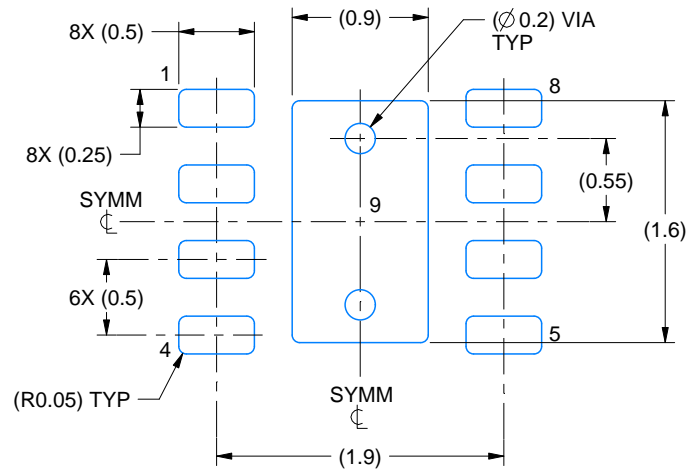

LAND PATTERN EXAMPLE
SCALE:20X

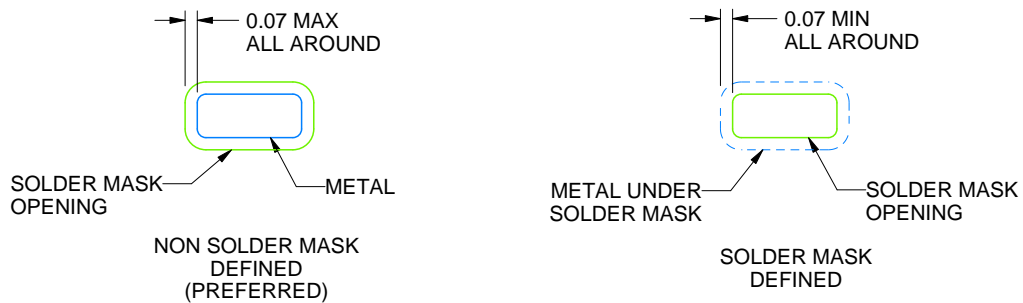

SOLDER MASK DETAILS

4218900/D 04/2020

NOTES: (continued)

4. This package is designed to be soldered to a thermal pad on the board. For more information, see Texas Instruments literature number SLUA271 (www.ti.com/lit/slua271).
5. Vias are optional depending on application, refer to device data sheet. If any vias are implemented, refer to their locations shown on this view. It is recommended that vias under paste be filled, plugged or tented.

EXAMPLE STENCIL DESIGN

DSG0008A

WSON - 0.8 mm max height

PLASTIC SMALL OUTLINE - NO LEAD

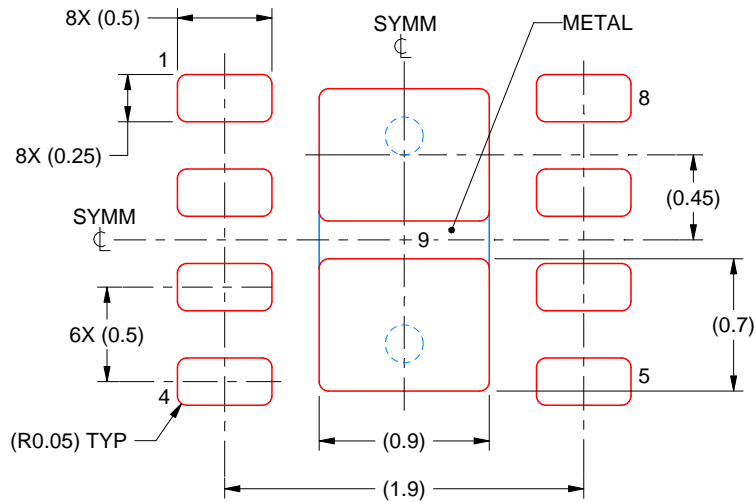

SOLDER PASTE EXAMPLE
BASED ON 0.125 mm THICK STENCIL

EXPOSED PAD 9:
87% PRINTED SOLDER COVERAGE BY AREA UNDER PACKAGE
SCALE:25X

4218900/D 04/2020

NOTES: (continued)

6. Laser cutting apertures with trapezoidal walls and rounded corners may offer better paste release. IPC-7525 may have alternate design recommendations.

PW0008A



PACKAGE OUTLINE
TSSOP - 1.2 mm max height

SMALL OUTLINE PACKAGE

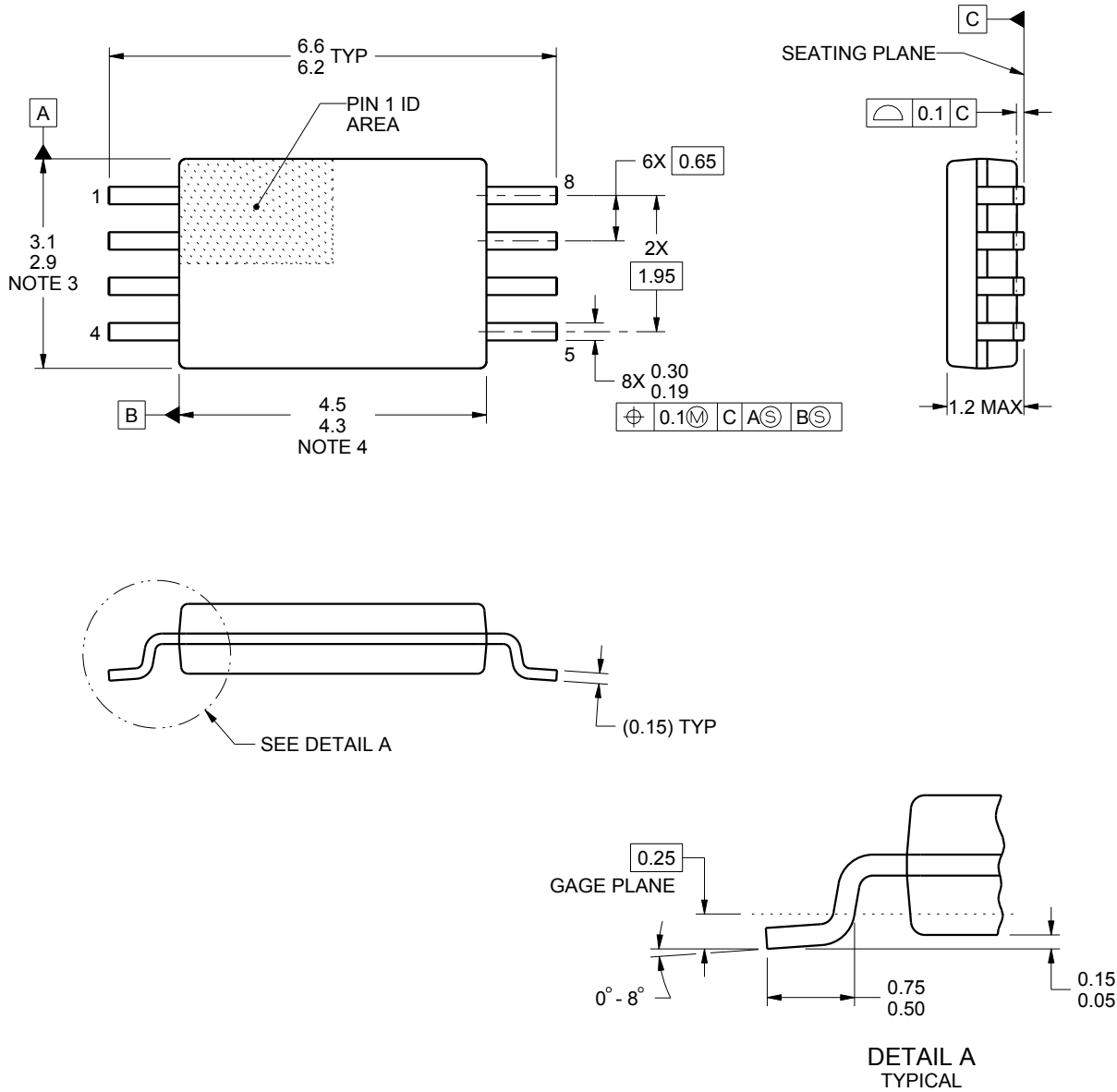

4221848/A 02/2015

NOTES:

1. All linear dimensions are in millimeters. Any dimensions in parenthesis are for reference only. Dimensioning and tolerancing per ASME Y14.5M.
2. This drawing is subject to change without notice.
3. This dimension does not include mold flash, protrusions, or gate burrs. Mold flash, protrusions, or gate burrs shall not exceed 0.15 mm per side.
4. This dimension does not include interlead flash. Interlead flash shall not exceed 0.25 mm per side.
5. Reference JEDEC registration MO-153, variation AA.

EXAMPLE BOARD LAYOUT

PW0008A

TSSOP - 1.2 mm max height

SMALL OUTLINE PACKAGE

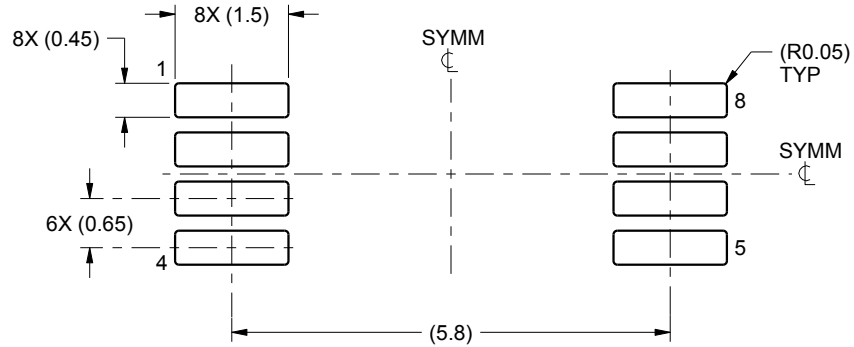

LAND PATTERN EXAMPLE
SCALE:10X

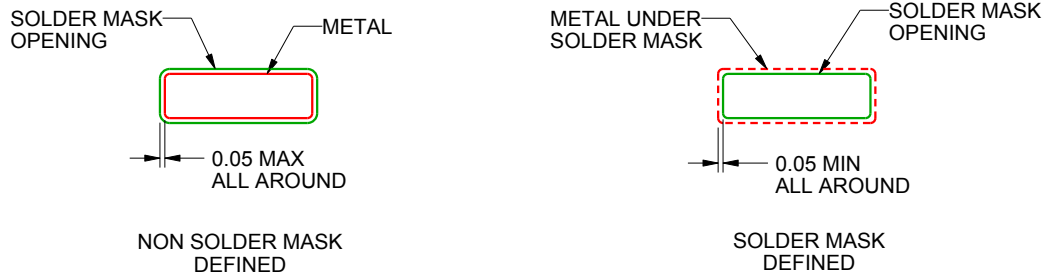

SOLDER MASK DETAILS
NOT TO SCALE

4221848/A 02/2015

NOTES: (continued)

6. Publication IPC-7351 may have alternate designs.
7. Solder mask tolerances between and around signal pads can vary based on board fabrication site.

EXAMPLE STENCIL DESIGN

PW0008A

TSSOP - 1.2 mm max height

SMALL OUTLINE PACKAGE

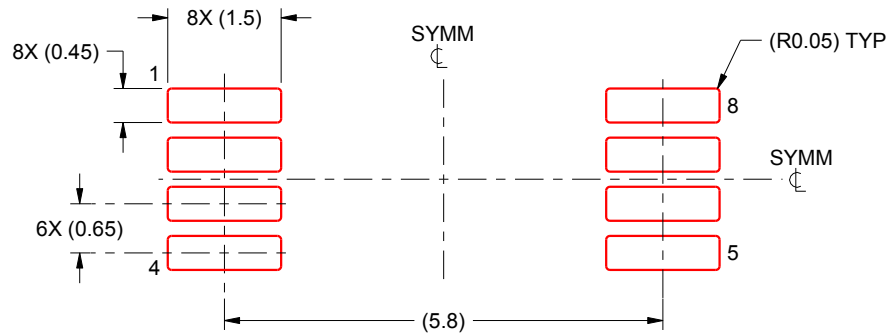

SOLDER PASTE EXAMPLE
BASED ON 0.125 mm THICK STENCIL
SCALE:10X

4221848/A 02/2015

NOTES: (continued)

8. Laser cutting apertures with trapezoidal walls and rounded corners may offer better paste release. IPC-7525 may have alternate design recommendations.
9. Board assembly site may have different recommendations for stencil design.

重要声明和免责声明

TI“按原样”提供技术和可靠性数据（包括数据表）、设计资源（包括参考设计）、应用或其他设计建议、网络工具、安全信息和其他资源，不保证没有瑕疵且不做任何明示或暗示的担保，包括但不限于对适销性、某特定用途方面的适用性或不侵犯任何第三方知识产权的暗示担保。

这些资源可供使用 TI 产品进行设计的熟练开发人员使用。您将自行承担以下全部责任：(1) 针对您的应用选择合适的 TI 产品，(2) 设计、验证并测试您的应用，(3) 确保您的应用满足相应标准以及任何其他功能安全、信息安全、监管或其他要求。

这些资源如有变更，恕不另行通知。TI 授权您仅可将这些资源用于研发本资源所述的 TI 产品的应用。严禁对这些资源进行其他复制或展示。您无权使用任何其他 TI 知识产权或任何第三方知识产权。您应全额赔偿因在这些资源的使用中对 TI 及其代表造成的任何索赔、损害、成本、损失和债务，TI 对此概不负责。

TI 提供的产品受上其他适用条款/TI 产品随附的其他适用条款的约束。TI 提供这些资源并不会扩展或以其他方式更改 TI 针对 TI 产品发布的适用的担保或担保免责声明。

TI 反对并拒绝您可能提出的任何其他或不同的条款。

邮寄地址：Texas Instruments, Post Office Box 655303, Dallas, Texas 75265

Copyright © 2021，德州仪器 (TI) 公司