

SGM2210

300mA, Low Quiescent Current and Low Noise Linear Regulator

GENERAL DESCRIPTION

The SGM2210 is a low dropout voltage regulator, which provides a maximum output current of 300mA from an input voltage in the range of 2.5V to 20V, with a typical dropout voltage of 80mV at 100mA output current.

The very low dropout voltage, low quiescent current and low noise make it suitable for battery-powered applications. The enable logic control function puts the SGM2210 in shutdown mode, allowing a total current consumption of 0.5µA (TYP). The device also includes a short-circuit constant current limiting and thermal protection.

The SGM2210 is available in a Green SOT-23-5 package. It operates over an operating temperature range of -40°C to +125°C.

FEATURES

- **Input Voltage Range: 2.5V to 20V**
- **Low Dropout Voltage: 80mV (TYP) at 100mA Load**
- **Low Quiescent Current: 36µA (TYP)**
- **Shutdown Current: 0.5µA (TYP)**
- **Output Voltage Accuracy: ±1% at +25°C**
- **300mA Guaranteed Output Current**
- **Fixed Output Voltage Versions: 1.2V to 5.0V with 100mV per Step**
- **Adjustable Output Voltages: 1.2V to 12V**
- **Logic-Controlled Shutdown**
- **Output Short-Circuit Constant Current Limiting and Thermal Protection**
- **-40°C to +125°C Operating Temperature Range**
- **Available in a Green SOT-23-5 Package**

APPLICATIONS

Battery-Powered Equipment
TV
Set-Top Box
PC and Laptop
Industrial

TYPICAL APPLICATION

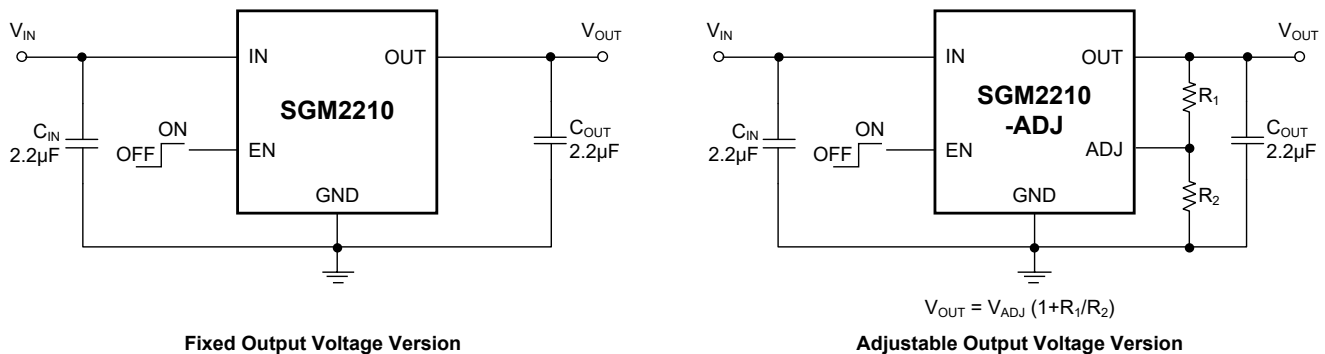

Figure 1. Typical Application Circuits

PACKAGE/ORDERING INFORMATION

MODEL	V _{OUT} (V)	PACKAGE DESCRIPTION	SPECIFIED TEMPERATURE RANGE	ORDERING NUMBER	PACKAGE MARKING	PACKING OPTION
SGM2210-1.2	1.2	SOT-23-5	-40°C to +125°C	SGM2210-1.2XN5G/TR	CC0XX	Tape and Reel, 3000
SGM2210-1.8	1.8	SOT-23-5	-40°C to +125°C	SGM2210-1.8XN5G/TR	CC6XX	Tape and Reel, 3000
SGM2210-2.5	2.5	SOT-23-5	-40°C to +125°C	SGM2210-2.5XN5G/TR	CCDXX	Tape and Reel, 3000
SGM2210-3.3	3.3	SOT-23-5	-40°C to +125°C	SGM2210-3.3XN5G/TR	MWDXX	Tape and Reel, 3000
SGM2210-5.0	5.0	SOT-23-5	-40°C to +125°C	SGM2210-5.0XN5G/TR	MWEXX	Tape and Reel, 3000
SGM2210-ADJ	Adjustable	SOT-23-5	-40°C to +125°C	SGM2210-ADJXN5G/TR	MWFXX	Tape and Reel, 3000

MARKING INFORMATION

NOTE: XX = Date Code.

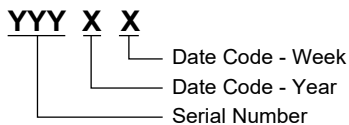

Green (RoHS & HSF): SG Micro Corp defines "Green" to mean Pb-Free (RoHS compatible) and free of halogen substances. If you have additional comments or questions, please contact your SGMICRO representative directly.

ABSOLUTE MAXIMUM RATINGS

DC Input Voltage Range..... -0.3V to 22V
 DC Output Voltage Range.....-0.3V to V_{IN} + 0.3V
 Enable Input Voltage Range.....-0.3V to V_{IN} + 0.3V
 ADJ Pin Voltage Range -0.3V to 2V
 Output Current..... Internally Limited
 Package Thermal Resistance
 SOT-23-5, θ_{JA}..... 170°C/W
 SOT-23-5, θ_{JB}..... 38°C/W
 SOT-23-5, θ_{JC}..... 52°C/W
 Junction Temperature+150°C
 Storage Temperature.....-65°C to +150°C
 Lead Temperature (Soldering, 10s)+260°C
 ESD Susceptibility
 HBM..... 8000V
 CDM 1000V

RECOMMENDED OPERATING CONDITIONS

Input Voltage Range2.5V to 20V
 Input Effective Capacitance, C_{IN} 1.5µF (MIN)
 Output Effective Capacitance, C_{OUT}..... 2.2µF to 22µF
 Operating Junction Temperature Range -40°C to +125°C

OVERSTRESS CAUTION

Stresses beyond those listed in Absolute Maximum Ratings may cause permanent damage to the device. Exposure to absolute maximum rating conditions for extended periods may affect reliability. Functional operation of the device at any conditions beyond those indicated in the Recommended Operating Conditions section is not implied.

ESD SENSITIVITY CAUTION

This integrated circuit can be damaged by ESD if you don't pay attention to ESD protection. SGMICRO recommends that all integrated circuits be handled with appropriate precautions. Failure to observe proper handling and installation procedures can cause damage. ESD damage can range from subtle performance degradation to complete device failure. Precision integrated circuits may be more susceptible to damage because very small parametric changes could cause the device not to meet its published specifications.

DISCLAIMER

SG Micro Corp reserves the right to make any change in circuit design, or specifications without prior notice.

PIN CONFIGURATIONS

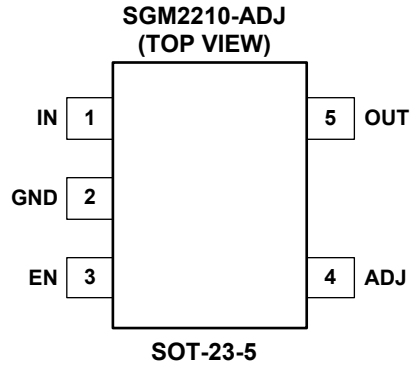
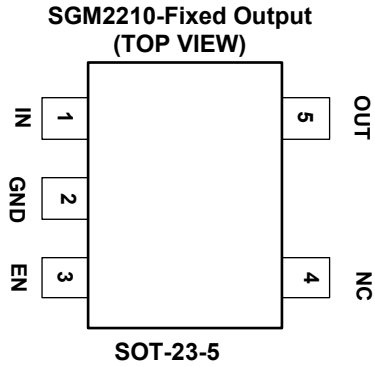

PIN DESCRIPTION

PIN	NAME	FUNCTION
1	IN	Regulator Input.
2	GND	Common Ground.
3	EN	Enable Pin Logic Input. Low = Shutdown, High = Active.
4	NC	Not Connected (fixed voltage version only).
	ADJ	Adjustable Pin (adjustable voltage version only). An external resistor divider sets the output voltage.
5	OUT	Regulator Output. It is recommended to use output capacitor with effective capacitance in the range of 2.2μF to 22μF.

ELECTRICAL CHARACTERISTICS

(Fixed version, $V_{IN} = V_{OUT(NOM)} + 1V$, $V_{EN} = V_{IN}$, $I_{OUT} = 1mA$, $C_{IN} = C_{OUT} = 2.2\mu F$, $T_J = -40^\circ C$ to $+125^\circ C$, typical values are at $T_J = +25^\circ C$, unless otherwise noted.)

PARAMETER	SYMBOL	CONDITIONS	TEMP	MIN	TYP	MAX	UNITS
Operating Input Voltage	V_{IN}		+25°C	2.5		20	V
Output Voltage Accuracy	V_{OUT}	$I_{OUT} = 1mA$	+25°C	-1		1	%
		$I_{OUT} = 1mA$ to 300mA	-40°C to +125°C	-1.5		1.5	
Line Regulation	$\frac{\Delta V_{OUT}}{\Delta V_{IN} \times V_{OUT}}$	$V_{IN} = (V_{OUT(NOM)} + 1V)$ to 20V, $I_{OUT} = 1mA$	+25°C		0.001	0.005	%/ V
			-40°C to +125°C			0.01	
Load Regulation	$\frac{\Delta V_{OUT}}{V_{OUT} \times \Delta I_{OUT}}$	$I_{OUT} = 1mA$ to 300mA	+25°C		0.0005	0.001	%/ mA
			-40°C to +125°C			0.003	
Dropout Voltage ⁽¹⁾	V_{DROP}	$I_{OUT} = 100mA$, $V_{OUT} = 3.3V$	+25°C		80	95	mV
			-40°C to +125°C			130	
		$I_{OUT} = 300mA$, $V_{OUT} = 3.3V$	+25°C		240	280	
			-40°C to +125°C			380	
Output Voltage Noise	e_n	$f = 10Hz$ to 100kHz, $I_{OUT} = 10mA$, $V_{OUT} = 3.3V$	+25°C		48		μV_{RMS}
Power Supply Rejection Ratio	PSRR	$V_{IN} = V_{OUT(NOM)} + 1V$, $\Delta V_{RIPPLE} = 0.2V_{P-P}$ $f = 1kHz$, $I_{OUT} = 10mA$, $V_{OUT} = 3.3V$	+25°C		100		dB
		$V_{IN} = V_{OUT(NOM)} + 1V$, $\Delta V_{RIPPLE} = 0.2V_{P-P}$ $f = 10kHz$, $I_{OUT} = 10mA$, $V_{OUT} = 3.3V$	+25°C		82		
Quiescent Current	I_Q	$V_{IN} = (V_{OUT(NOM)} + 1V)$ to 20V, $I_{OUT} = 0mA$	+25°C		36	50	μA
			-40°C to +125°C			60	
		$V_{IN} = (V_{OUT(NOM)} + 1V)$ to 20V, $I_{OUT} = 300mA$	+25°C		620	720	
			-40°C to +125°C			760	
Shutdown Current	I_{SHDN}	$V_{EN} = GND$	+25°C		0.5	1	μA
			-40°C to +125°C			1.5	
Output Current Limit ⁽²⁾	I_{LIMIT}	$V_{OUT} = 90\%V_{OUT(NOM)}$	+25°C	550	900		mA
Short Circuit Current	I_{SHORT}	$V_{OUT} = 0V$	+25°C		600		mA
Enable Input Logic Low	V_{IL}	$V_{IN} = 2.5V$ to 20V	-40°C to +125°C			0.4	V
Enable Input Logic High	V_{IH}	$V_{IN} = 2.5V$ to 20V	-40°C to +125°C	1.3			
EN Pin Input Current	I_{EN}	$V_{EN} = V_{IN}$	+25°C		300	600	nA
			-40°C to +125°C			1000	
Output Discharge Resistance	R_{DIS}	$V_{IN} = 2.5V$, $V_{EN} = 0V$	+25°C		95		Ω
Thermal Shutdown Temperature	T_{SHDN}				155		°C
Thermal Shutdown Hysteresis	ΔT_{SHDN}				20		°C

NOTES:

- Dropout voltage is characterized when V_{OUT} falls 5% below $V_{OUT(NOM)}$.
- The maximum current has to be limited according to the maximum power dissipation.

ELECTRICAL CHARACTERISTICS (continued)

(Adjustable version, $V_{IN} = V_{OUT(NOM)} + 1V$, $V_{EN} = V_{IN}$, $I_{OUT} = 1mA$, $C_{IN} = C_{OUT} = 2.2\mu F$, $T_J = -40^\circ C$ to $+125^\circ C$, typical values are at $T_J = +25^\circ C$, unless otherwise noted.)

PARAMETER	SYMBOL	CONDITIONS	TEMP	MIN	TYP	MAX	UNITS
Operating Input Voltage	V_{IN}		$+25^\circ C$	2.5		20	V
Adjustable Voltage	V_{ADJ}		$+25^\circ C$		1.2		V
Adjustable Voltage Accuracy		$I_{OUT} = 1mA$	$+25^\circ C$	-1		1	%
		$I_{OUT} = 1mA$ to $300mA$	$-40^\circ C$ to $+125^\circ C$	-1.5		1.5	
Line Regulation	$\frac{\Delta V_{OUT}}{\Delta V_{IN} \times V_{OUT}}$	$V_{IN} = (V_{OUT(NOM)} + 1V)$ to $20V$, $I_{OUT} = 1mA$	$+25^\circ C$		0.001	0.005	%/ V
			$-40^\circ C$ to $+125^\circ C$			0.01	
Load Regulation	$\frac{\Delta V_{OUT}}{V_{OUT} \times \Delta I_{OUT}}$	$I_{OUT} = 1mA$ to $300mA$	$+25^\circ C$		0.0005	0.001	%/ mA
			$-40^\circ C$ to $+125^\circ C$			0.003	
Dropout Voltage ⁽¹⁾	V_{DROP}	$I_{OUT} = 100mA$, $V_{OUT} = 3.3V$	$+25^\circ C$		80	95	mV
			$-40^\circ C$ to $+125^\circ C$			130	
		$I_{OUT} = 300mA$, $V_{OUT} = 3.3V$	$+25^\circ C$		240	280	
			$-40^\circ C$ to $+125^\circ C$			380	
Output Voltage Noise	e_n	$f = 10Hz$ to $100kHz$, $I_{OUT} = 10mA$, $V_{OUT} = 3.3V$	$+25^\circ C$		48		μV_{RMS}
ADJ Pin Current	I_{ADJ}		$+25^\circ C$		1	3	nA
			$-40^\circ C$ to $+125^\circ C$			5	
Power Supply Rejection Ratio	PSRR	$V_{IN} = V_{OUT(NOM)} + 1V$, $\Delta V_{RIPPLE} = 0.2V_{P-P}$, $f = 1kHz$, $I_{OUT} = 10mA$, $V_{OUT} = 3.3V$	$+25^\circ C$		100		dB
		$V_{IN} = V_{OUT(NOM)} + 1V$, $\Delta V_{RIPPLE} = 0.2V_{P-P}$, $f = 10kHz$, $I_{OUT} = 10mA$, $V_{OUT} = 3.3V$	$+25^\circ C$		82		
Quiescent Current	I_Q	$V_{IN} = (V_{OUT(NOM)} + 1V)$ to $20V$, $I_{OUT} = 0mA$	$+25^\circ C$		36	50	μA
			$-40^\circ C$ to $+125^\circ C$			60	
		$V_{IN} = (V_{OUT(NOM)} + 1V)$ to $20V$, $I_{OUT} = 300mA$	$+25^\circ C$		620	720	
			$-40^\circ C$ to $+125^\circ C$			760	
Shutdown Current	I_{SHDN}	$V_{EN} = GND$	$+25^\circ C$		0.5	1	μA
			$-40^\circ C$ to $+125^\circ C$			1.5	
Current Limit ⁽²⁾	I_{LIMIT}	$V_{OUT} = 90\%V_{OUT(NOM)}$	$+25^\circ C$	550	900		mA
Short Circuit Current	I_{SHORT}	$V_{OUT} = 0V$	$+25^\circ C$		600		mA
Enable Input Logic Low	V_{IL}	$V_{IN} = 2.5V$ to $20V$	$-40^\circ C$ to $+125^\circ C$			0.4	V
Enable Input Logic High	V_{IH}	$V_{IN} = 2.5V$ to $20V$	$-40^\circ C$ to $+125^\circ C$	1.3			
EN Pin Input Current	I_{EN}	$V_{EN} = V_{IN}$	$+25^\circ C$		300	600	nA
			$-40^\circ C$ to $+125^\circ C$			1000	
Output Discharge Resistance	R_{DIS}	$V_{IN} = 2.5V$, $V_{EN} = 0V$	$+25^\circ C$		95		Ω
Thermal Shutdown Temperature	T_{SHDN}				155		$^\circ C$
Thermal Shutdown Hysteresis	ΔT_{SHDN}				20		$^\circ C$

NOTES:

- Dropout voltage is characterized when V_{OUT} falls 5% below $V_{OUT(NOM)}$.
- The maximum current has to be limited according to the maximum power dissipation.

TYPICAL PERFORMANCE CHARACTERISTICS

$T_J = +25^\circ\text{C}$, $V_{IN} = V_{OUT(NOM)} + 1\text{V}$, $V_{EN} = V_{IN}$, $C_{IN} = C_{OUT} = 2.2\mu\text{F}$, unless otherwise noted.

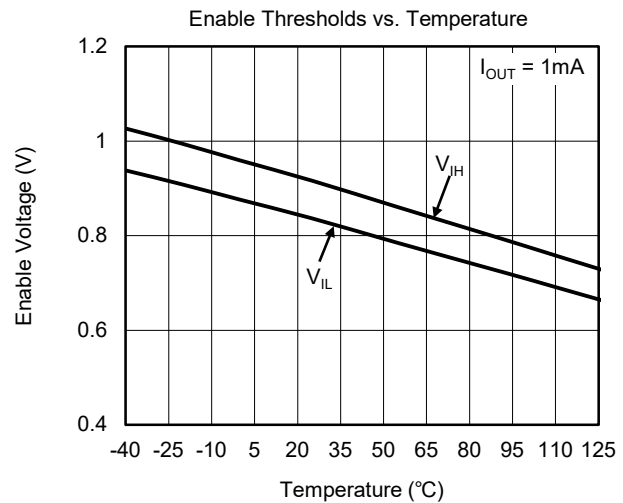
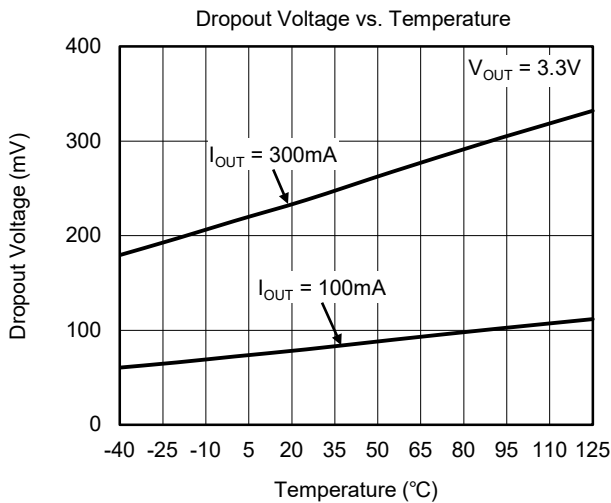
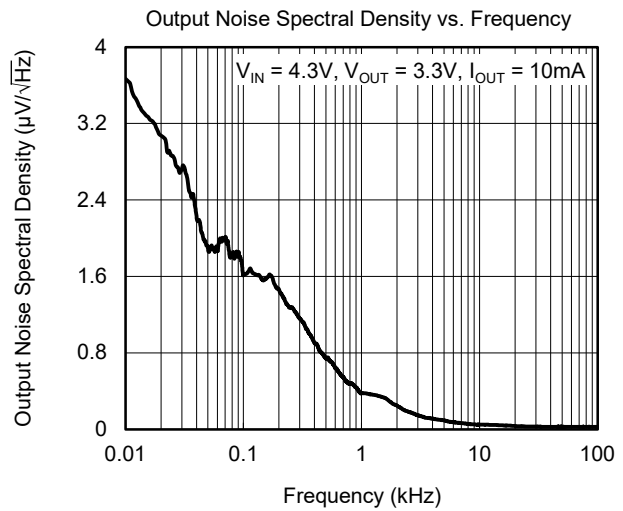
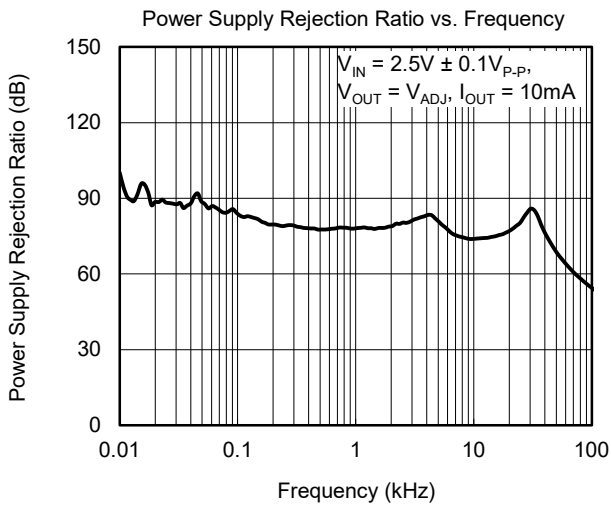
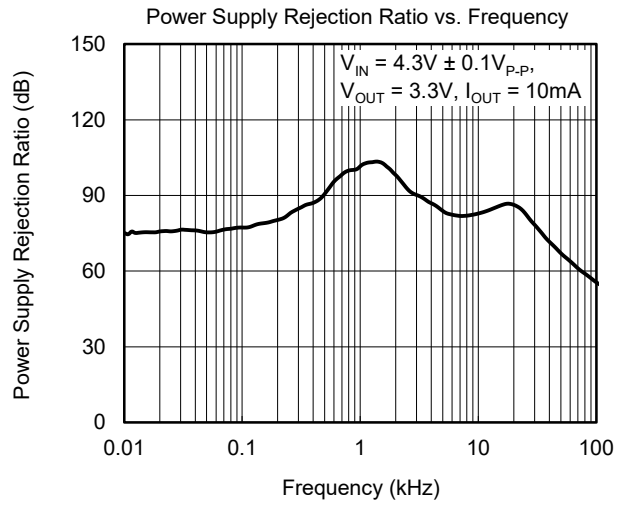
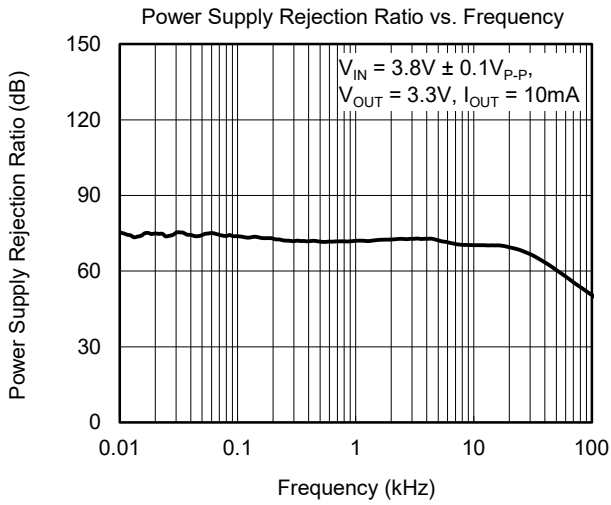

TYPICAL PERFORMANCE CHARACTERISTICS (continued)

$T_J = +25^\circ\text{C}$, $V_{IN} = V_{OUT(NOM)} + 1\text{V}$, $V_{EN} = V_{IN}$, $C_{IN} = C_{OUT} = 2.2\mu\text{F}$, unless otherwise noted.

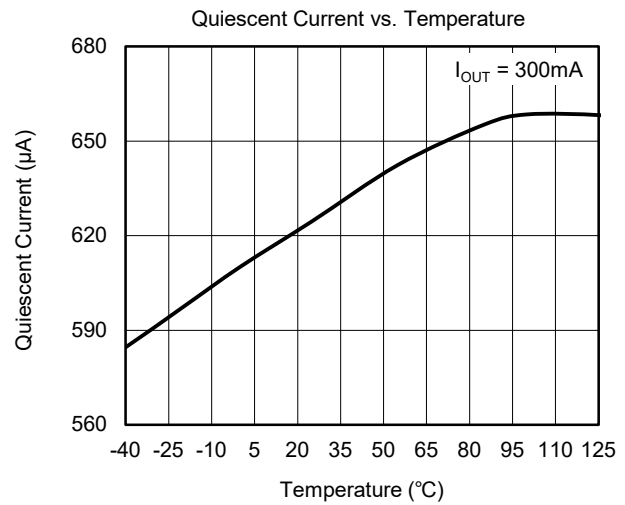
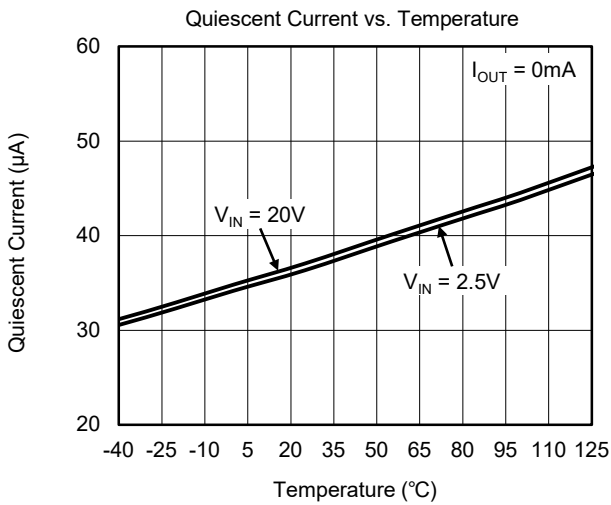
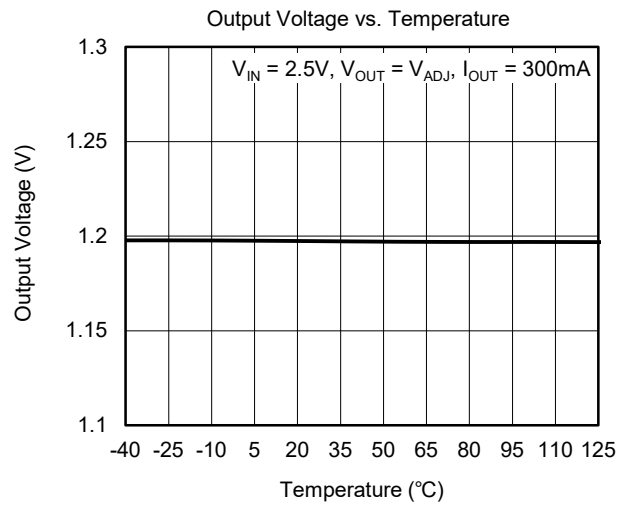
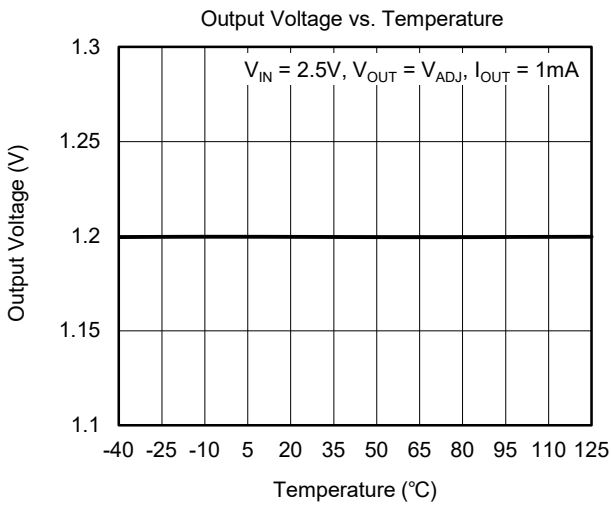
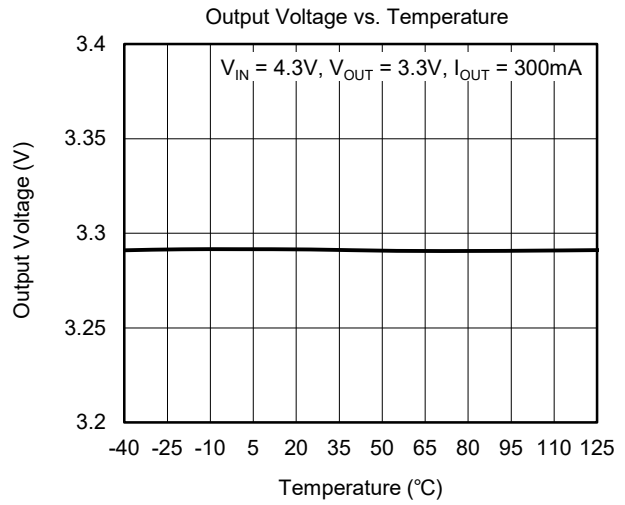
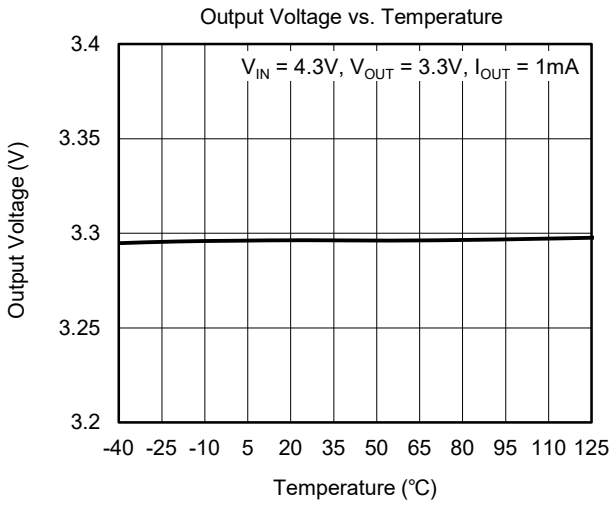

TYPICAL PERFORMANCE CHARACTERISTICS (continued)

$T_J = +25^\circ\text{C}$, $V_{IN} = V_{OUT(NOM)} + 1\text{V}$, $V_{EN} = V_{IN}$, $C_{IN} = C_{OUT} = 2.2\mu\text{F}$, unless otherwise noted.

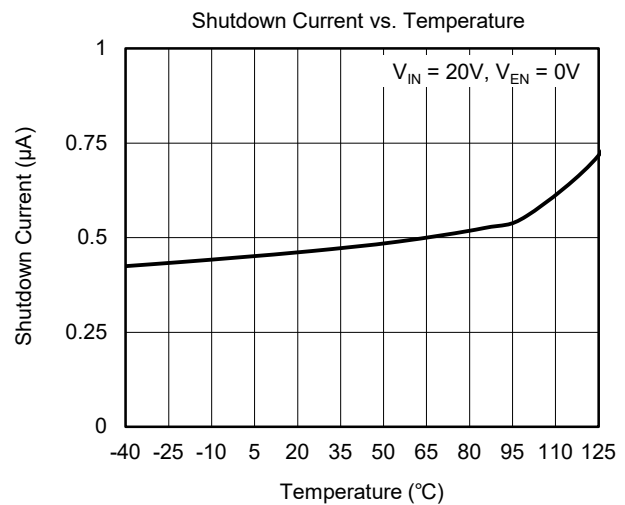
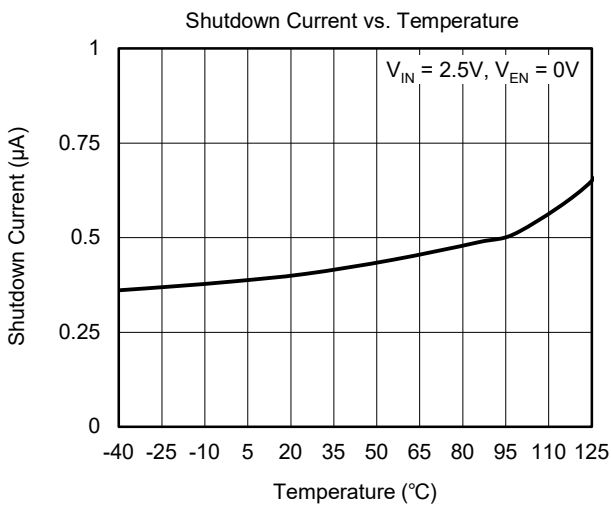
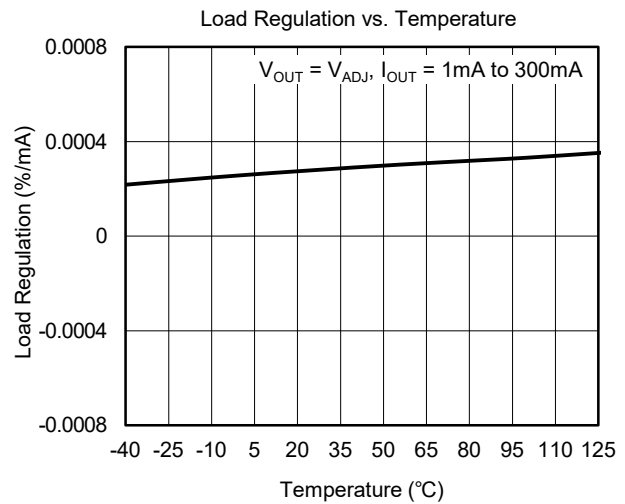
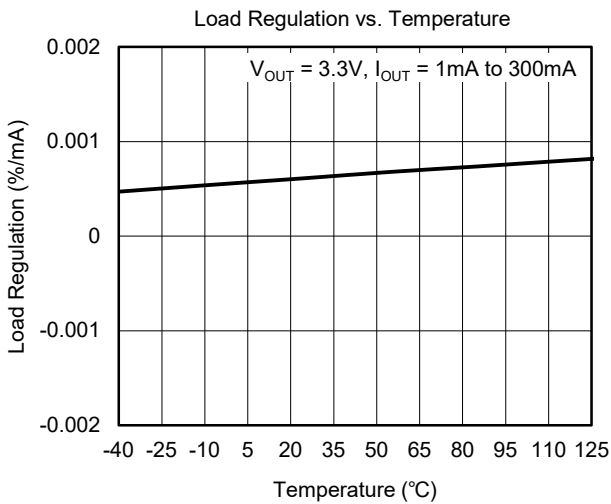
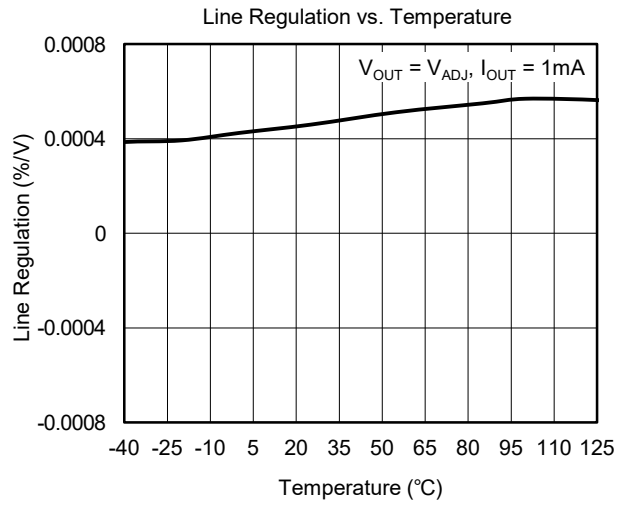
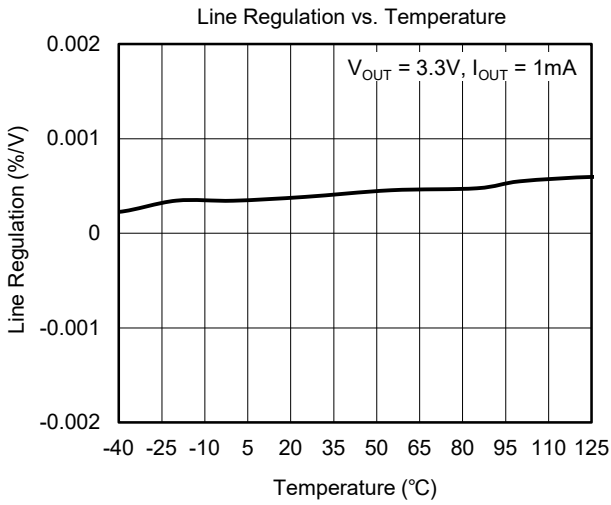

TYPICAL PERFORMANCE CHARACTERISTICS (continued)

$T_J = +25^\circ\text{C}$, $V_{IN} = V_{OUT(NOM)} + 1\text{V}$, $V_{EN} = V_{IN}$, $C_{IN} = C_{OUT} = 2.2\mu\text{F}$, unless otherwise noted.

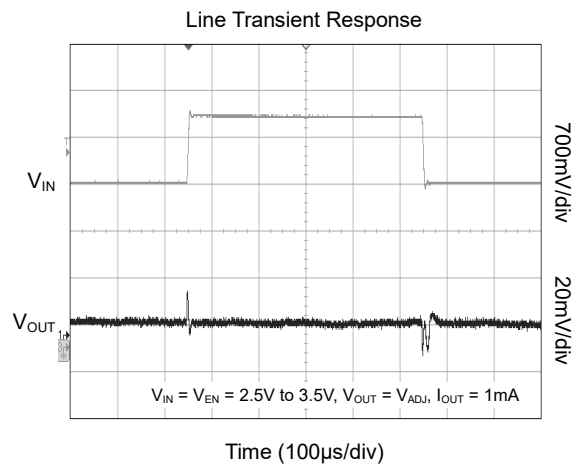
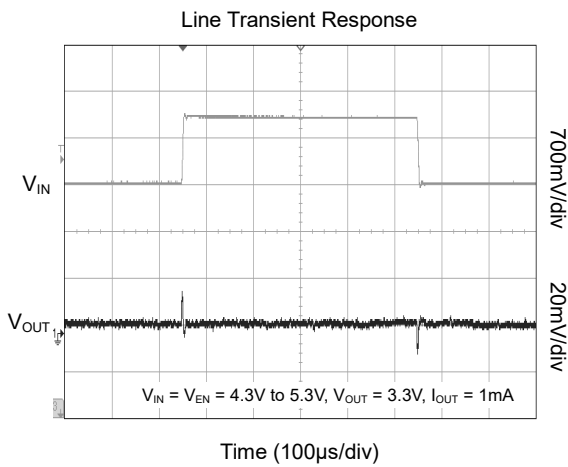
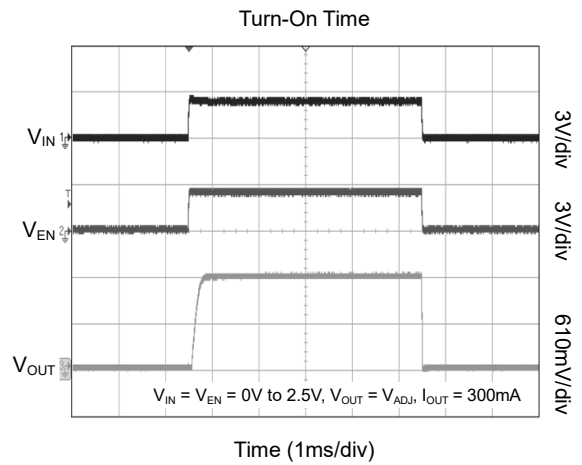
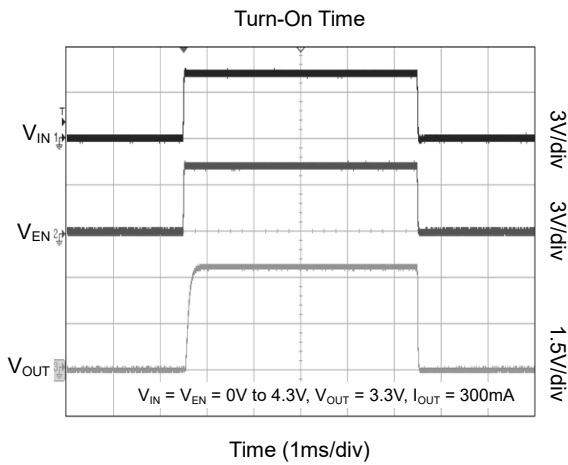
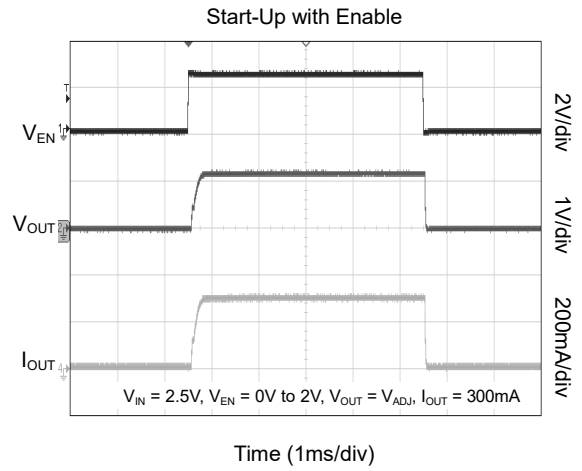
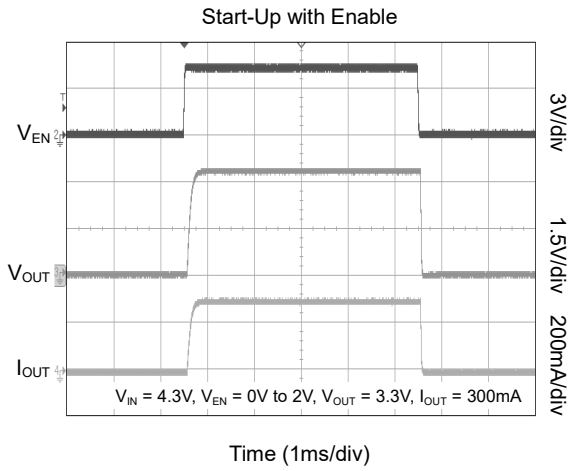

TYPICAL PERFORMANCE CHARACTERISTICS (continued)

$T_J = +25^\circ\text{C}$, $V_{IN} = V_{OUT(NOM)} + 1\text{V}$, $V_{EN} = V_{IN}$, $C_{IN} = C_{OUT} = 2.2\mu\text{F}$, unless otherwise noted.

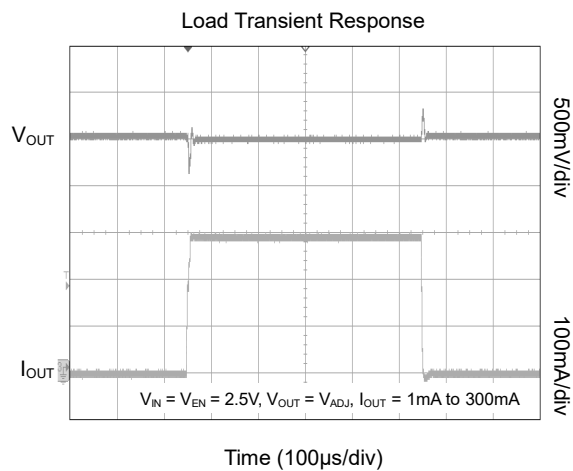
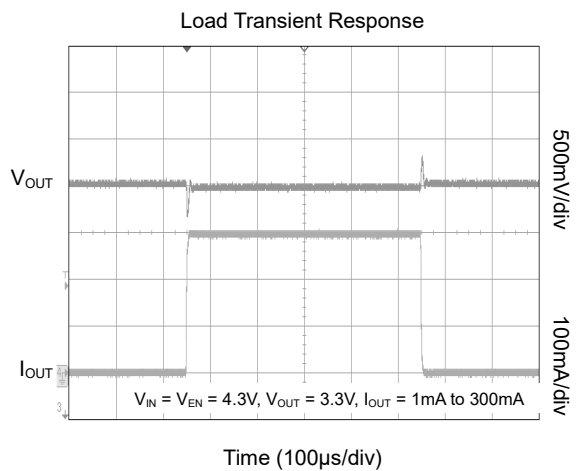

FUNCTIONAL BLOCK DIAGRAM

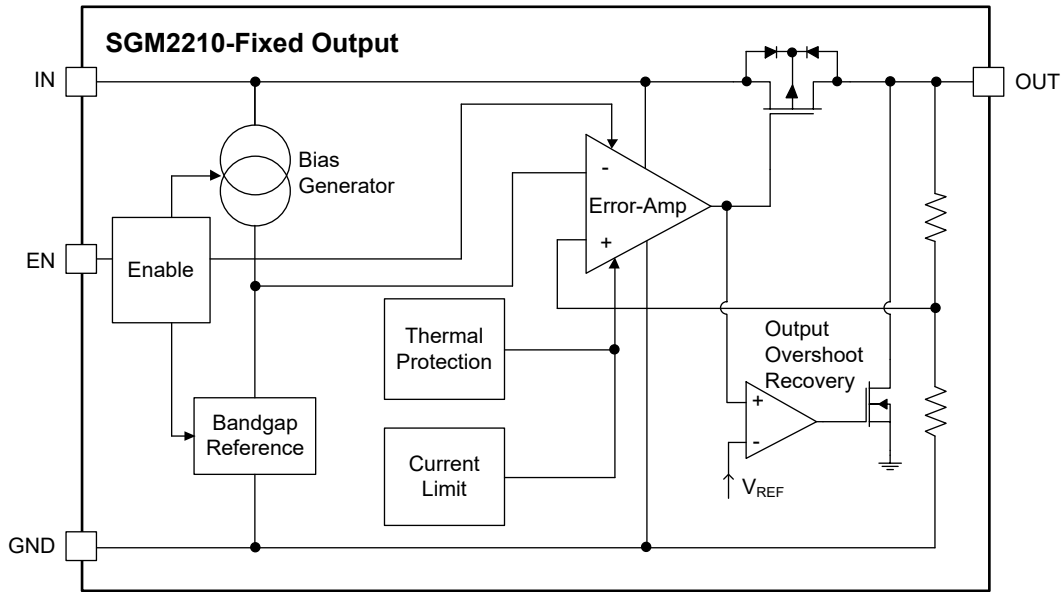

Figure 2. Fixed Version Block Diagram

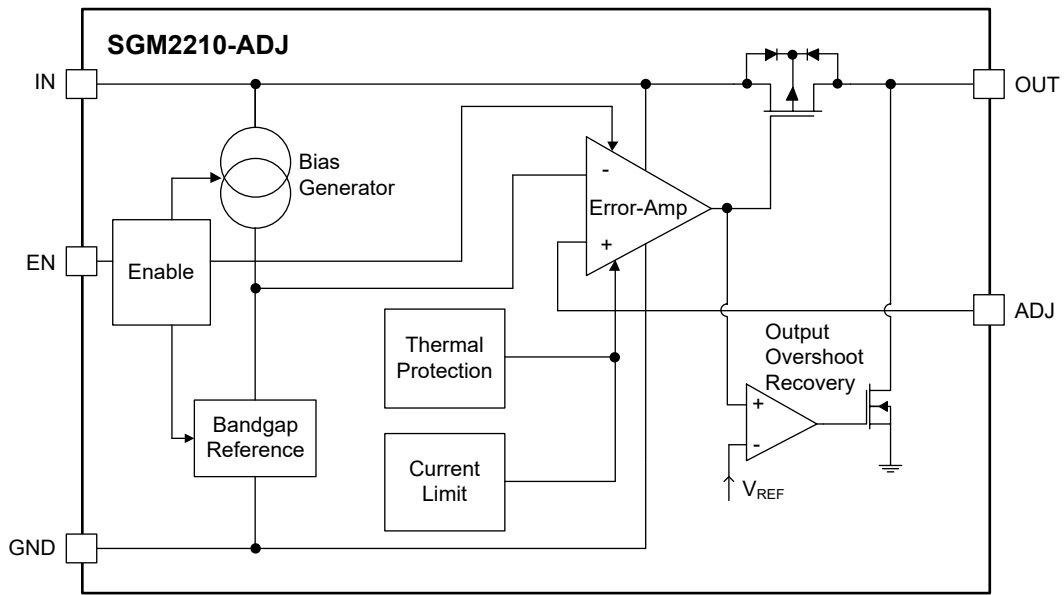

Figure 3. Adjustable Version Block Diagram

APPLICATION INFORMATION

Overview

The SGM2210 is a linear regulator designed primarily for high input voltage applications. The SGM2210 series is available in several fixed output voltages and adjustable output version (from 1.2V to 12V with a simple resistor divider). The maximum output current is dependent on the package’s maximum power dissipation for a given temperature.

The SGM2210 uses external feedback, allowing the user to set the output voltage with an external resistor divider. The typical ADJ pin voltage is 1.2V.

The IC enters shutdown mode when EN is low. In shutdown mode, the pass transistor and control circuitry are turned off, reducing the supply current to 1µA (MAX). Connect EN to VIN for automatic startup.

Setting the Output Voltage

Set the output voltage of the SGM2210 by using a resistor divider as shown:

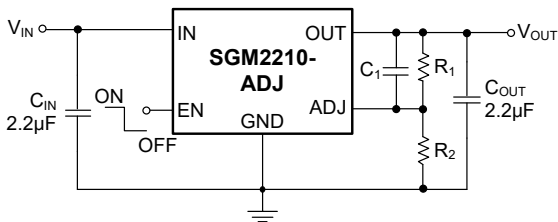

Figure 4. SGM2210-ADJ with External Resistor Divider

Choose R₂ = 150kΩ to maintain an 8µA load. Calculate the value for R₁ using the following equation:

$$R_1 = R_2 \times \left(\frac{V_{OUT}}{1.2V} - 1 \right)$$

Input Capacitor and Output Capacitor

For proper operation, place a 2.2µF ceramic capacitor (C_{IN}) between the input pin and ground. Larger values in this range will help improve line transient response.

For stable operation, use a ceramic capacitor (C_{OUT}) between 2.2µF and 22µF. Larger values in this range will help improve load transient response and reduce noise. Output capacitors of other dielectric types may be used, but are not recommended as their capacitance can deviate greatly from their rated value over temperature.

Thermal Considerations

When the junction temperature is too high, the thermal protection circuitry sends a signal to the control logic that will shut down the IC. The IC will restart when the temperature has sufficiently cooled down.

The maximum power dissipation is dependent on the thermal resistance of the case and the circuit board, the temperature difference between the die junction and the ambient air, and the rate of air flow.

Output Noise

The SGM2210 will exhibit noise on the output during normal operation. This noise is negligible for most applications. However, in applications that include analog-to-digital converters (ADCs) of more than 12 bits, one needs to consider the ADC’s power supply rejection specifications.

REVISION HISTORY

NOTE: Page numbers for previous revisions may differ from page numbers in the current version.

DECEMBER 2021 – REV.A to REV.A.1	Page
Updated Electrical Characteristics section.....	4, 5
Changes from Original (DECEMBER 2019) to REV.A.....	Page
Changed from product preview to production data.....	All

PACKAGE INFORMATION

PACKAGE OUTLINE DIMENSIONS

SOT-23-5

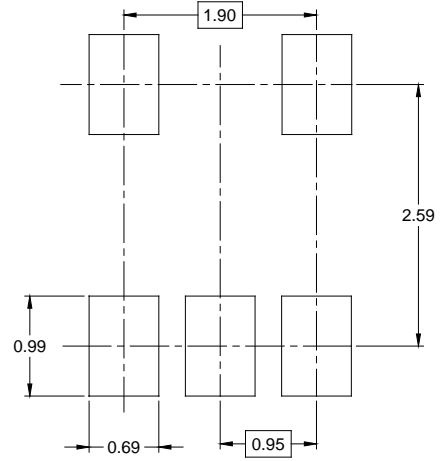
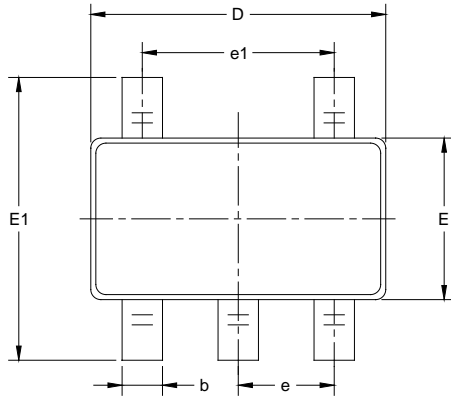

RECOMMENDED LAND PATTERN (Unit: mm)

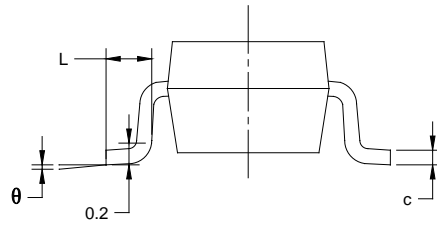
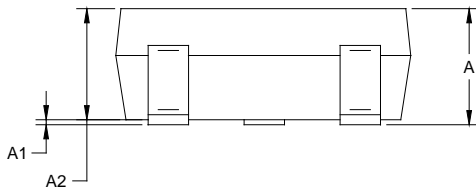

Symbol	Dimensions In Millimeters		Dimensions In Inches	
	MIN	MAX	MIN	MAX
A	1.050	1.250	0.041	0.049
A1	0.000	0.100	0.000	0.004
A2	1.050	1.150	0.041	0.045
b	0.300	0.500	0.012	0.020
c	0.100	0.200	0.004	0.008
D	2.820	3.020	0.111	0.119
E	1.500	1.700	0.059	0.067
E1	2.650	2.950	0.104	0.116
e	0.950 BSC		0.037 BSC	
e1	1.900 BSC		0.075 BSC	
L	0.300	0.600	0.012	0.024
θ	0°	8°	0°	8°

NOTES:

1. Body dimensions do not include mode flash or protrusion.
2. This drawing is subject to change without notice.

PACKAGE INFORMATION

TAPE AND REEL INFORMATION

REEL DIMENSIONS

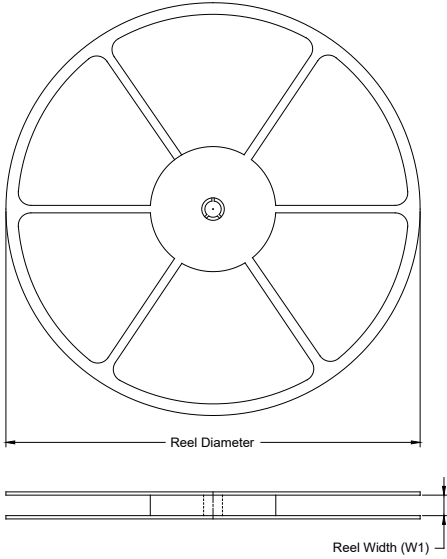

TAPE DIMENSIONS

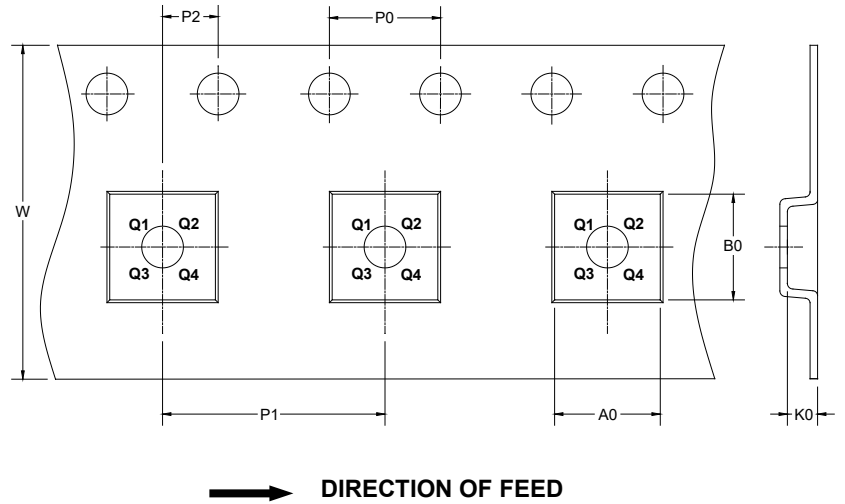

NOTE: The picture is only for reference. Please make the object as the standard.

KEY PARAMETER LIST OF TAPE AND REEL

Package Type	Reel Diameter	Reel Width W1 (mm)	A0 (mm)	B0 (mm)	K0 (mm)	P0 (mm)	P1 (mm)	P2 (mm)	W (mm)	Pin1 Quadrant
SOT-23-5	7"	9.5	3.20	3.20	1.40	4.0	4.0	2.0	8.0	Q3

DD0001

PACKAGE INFORMATION

CARTON BOX DIMENSIONS



NOTE: The picture is only for reference. Please make the object as the standard.

KEY PARAMETER LIST OF CARTON BOX

Reel Type	Length (mm)	Width (mm)	Height (mm)	Pizza/Carton
7" (Option)	368	227	224	8
7"	442	410	224	18

DD0002