

LM2904

Dual Operational Amplifier

GENERAL DESCRIPTION

The LM2904 consists of two independent, high-gain frequency-compensated operational amplifiers designed to operate from a single supply or dual supplies over a wide range of voltages.

The LM2904 is available in Green SOIC-8, MSOP-8 and TSSOP-8 packages. It is specified over the -40°C to +125°C temperature range.

APPLICATIONS

Blu-ray Players and Home Theaters

Chemical and Gas Sensors

DVD Recorders and Players

Digital Multimeter: Bench and Systems

Digital Multimeter: Handhelds

Field Transmitter: Temperature Sensors

Motor Control: AC Induction, Brushed DC, Brushless DC, High-Voltage, Low-Voltage, Permanent Magnet, and Stepper Motors

Oscilloscopes

TV: LCD and Digital

Temperature Sensors or Controllers Using Modbus

Weigh Scales

FEATURES

- **Wide Supply Ranges**
 - Single Supply: 3V to 32V
 - Dual Supplies: $\pm 1.5V$ to $\pm 16V$
- **Low Quiescent Current: 440 μ A (TYP)**
- **Gain-Bandwidth Product: 1.1MHz**
- **Input Common Mode Voltage Range Includes Ground, Allowing Direct Sensing Near Ground**
- **Low Input Offset Voltage: 5.8mV (MAX)**
- **Low Input Offset Current: 10pA (TYP)**
- **Low Input Bias Current: 10pA (TYP)**
- **Differential Input Voltage Range Equal to Maximum-Rated Supply Voltage: 32V**
- **Open-Loop Differential Voltage Gain: 111dB (TYP)**
- **Internal Frequency Compensation**
- **-40°C to +125°C Operating Temperature Range**
- **Available in Green SOIC-8, MSOP-8 and TSSOP-8 Packages**

PACKAGE/ORDERING INFORMATION

| MODEL | PACKAGE DESCRIPTION | SPECIFIED TEMPERATURE RANGE | ORDERING NUMBER | PACKAGE MARKING | PACKING OPTION |
|--------|---------------------|-----------------------------|-----------------|-------------------------|---------------------|
| LM2904 | SOIC-8 | -40°C to +125°C | LM2904XS8G/TR | LM 2904XS8 XXXXX | Tape and Reel, 4000 |
| | MSOP-8 | -40°C to +125°C | LM2904XMS8G/TR | LM2904 XMS8 XXXXX | Tape and Reel, 4000 |
| | TSSOP-8 | -40°C to +125°C | LM2904XTS8G/TR | LM2904 XTS8 XXXXX | Tape and Reel, 4000 |

MARKING INFORMATION

NOTE: XXXXX = Date Code, Trace Code and Vendor Code.

XXXXX

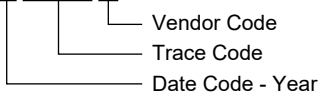

Green (RoHS & HSF): SG Micro Corp defines "Green" to mean Pb-Free (RoHS compatible) and free of halogen substances. If you have additional comments or questions, please contact your SGMICRO representative directly.

ABSOLUTE MAXIMUM RATINGS

| | |
|---|-----------------|
| Supply Voltage, V_s ⁽¹⁾ | -0.3V to 34V |
| Differential Input Voltage, V_{ID} ⁽²⁾ | -32V to 32V |
| Input Voltage (Either Input) | -0.3V to 32V |
| Junction Temperature | +150°C |
| Storage Temperature Range | -65°C to +150°C |
| Lead Temperature (Soldering, 10s) | +260°C |
| ESD Susceptibility | |
| HBM | 6000V |
| CDM | 1000V |

RECOMMENDED OPERATING CONDITIONS

| | |
|---------------------------------|-----------------------|
| Input Common Mode Voltage Range | -0.1V to $V_s - 1.5V$ |
| Operating Temperature Range | -40°C to +125°C |

NOTES:

- All voltage values (except differential voltages and V_s specified for the measurement of I_{SC}) are with respect to the network GND.
- Differential voltages are at +IN, with respect to -IN.

OVERSTRESS CAUTION

Stresses beyond those listed in Absolute Maximum Ratings may cause permanent damage to the device. Exposure to absolute maximum rating conditions for extended periods may affect reliability. Functional operation of the device at any conditions beyond those indicated in the Recommended Operating Conditions section is not implied.

ESD SENSITIVITY CAUTION

This integrated circuit can be damaged if ESD protections are not considered carefully. SGMICRO recommends that all integrated circuits be handled with appropriate precautions. Failure to observe proper handling and installation procedures can cause damage. ESD damage can range from subtle performance degradation to complete device failure. Precision integrated circuits may be more susceptible to damage because even small parametric changes could cause the device not to meet the published specifications.

DISCLAIMER

SG Micro Corp reserves the right to make any change in circuit design, or specifications without prior notice.

PIN CONFIGURATIONS

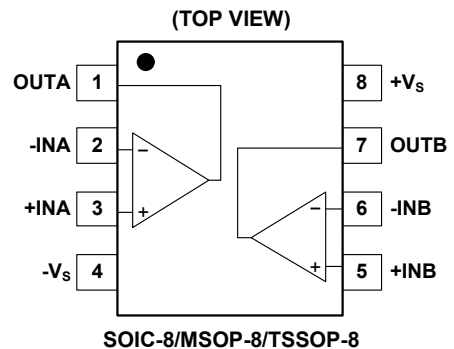

ELECTRICAL CHARACTERISTICS

(At $T_A = +25^\circ\text{C}$, $V_S = 3\text{V}$ to 32V , $R_L = 10\text{k}\Omega$ connected to $V_S/2$, $-0.1\text{V} < V_{CM} < V_S - 1.5\text{V}$, Full = -40°C to $+125^\circ\text{C}$, unless otherwise noted.)

| PARAMETER | SYMBOL | CONDITIONS | TEMP | MIN | TYP | MAX | UNITS |
|---|------------|---|-------|------|------|-------------|------------------------------|
| Input Characteristics | | | | | | | |
| Input Offset Voltage | V_{OS} | | +25°C | | 1.2 | 5.8 | mV |
| | | | Full | | | 6.8 | |
| Input Bias Current | I_B | $V_S = 32\text{V}$, $V_{CM} = V_S/2$ | +25°C | | 10 | 160 | pA |
| Input Offset Current | I_{OS} | $V_S = 32\text{V}$, $V_{CM} = V_S/2$ | +25°C | | 10 | 100 | pA |
| Maximum Differential Input Voltage | $ V_{ID} $ | | Full | | | V_S | V |
| Input Common Mode Voltage Range | V_{CM} | | Full | -0.1 | | $V_S - 1.5$ | V |
| Common Mode Rejection Ratio | CMRR | $-0.1\text{V} < V_{CM} < V_S - 1.5\text{V}$ | +25°C | 82 | 118 | | dB |
| | | | Full | 72 | | | |
| Open-Loop Voltage Gain | A_{OL} | $R_L = 10\text{k}\Omega$ to $V_S/2$ | +25°C | 92 | 111 | | dB |
| | | | Full | 83 | | | |
| Output Characteristics | | | | | | | |
| High-Level Output Voltage | V_{OH} | $R_L = 10\text{k}\Omega$ | +25°C | | 42 | 60 | mV |
| | | | Full | | | 80 | |
| Low-Level Output Voltage | V_{OL} | $R_L = 10\text{k}\Omega$ | +25°C | | 110 | 190 | mV |
| | | | Full | | | 240 | |
| Output Short-Circuit Current | I_{SC} | | +25°C | 12 | 18 | | mA |
| Power Supply | | | | | | | |
| Operating Voltage Range | V_S | | Full | 3 | | 32 | V |
| Quiescent Current | I_Q | $I_{OUT} = 0$ | +25°C | | 440 | 680 | μA |
| | | | Full | | | 950 | |
| Power Supply Rejection Ratio | PSRR | | +25°C | 102 | 122 | | dB |
| | | | Full | 98 | | | |
| Turn-On Time | | $G = +1$ | +25°C | | 42 | | μs |
| Dynamic Performance ($C_{LOAD} = 100\text{pF}$) | | | | | | | |
| Gain-Bandwidth Product | GBP | | +25°C | | 1.1 | | MHz |
| Phase Margin | | | +25°C | | 60 | | ° |
| Slew Rate | SR | $G = +1$ | +25°C | | 0.35 | | $\text{V}/\mu\text{s}$ |
| Overload Recovery Time | ORT | $V_{IN} \times G > V_S$ | +25°C | | 2.3 | | μs |
| Noise | | | | | | | |
| Input Voltage Noise | | $f = 0.1\text{Hz}$ to 10Hz | +25°C | | 8.7 | | μV_{P-P} |
| Input Voltage Noise Density | e_n | $f = 1\text{kHz}$ | +25°C | | 36 | | $\text{nV}/\sqrt{\text{Hz}}$ |

TYPICAL PERFORMANCE CHARACTERISTICS

At $T_A = +25^\circ\text{C}$, $V_{CM} = V_S/2$, unless otherwise noted.

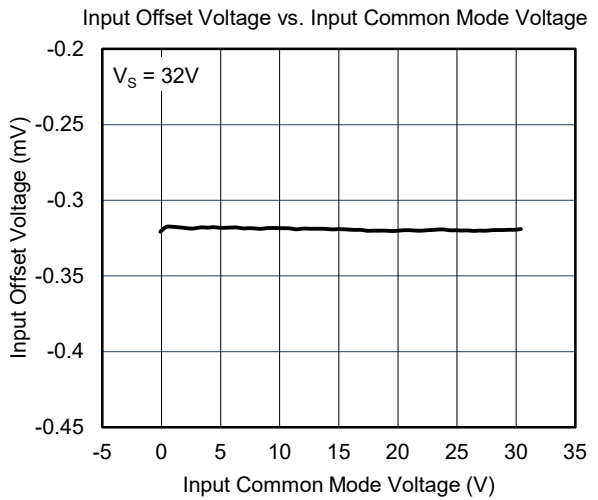
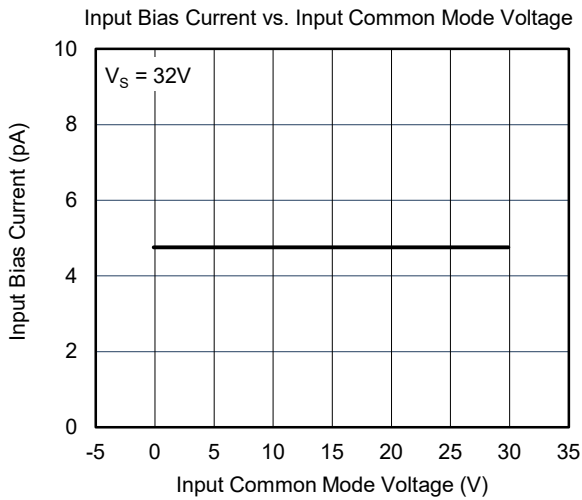
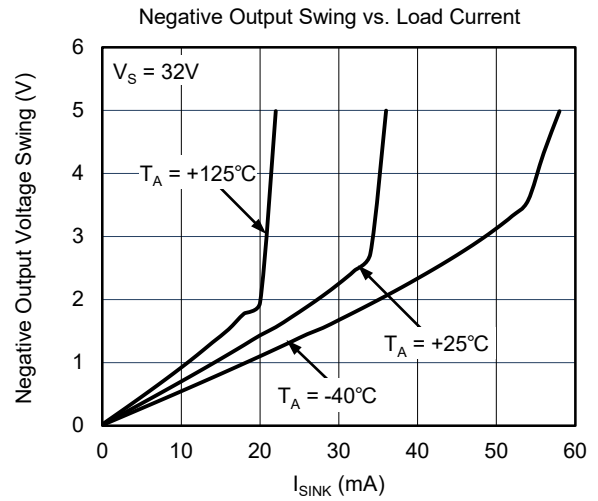
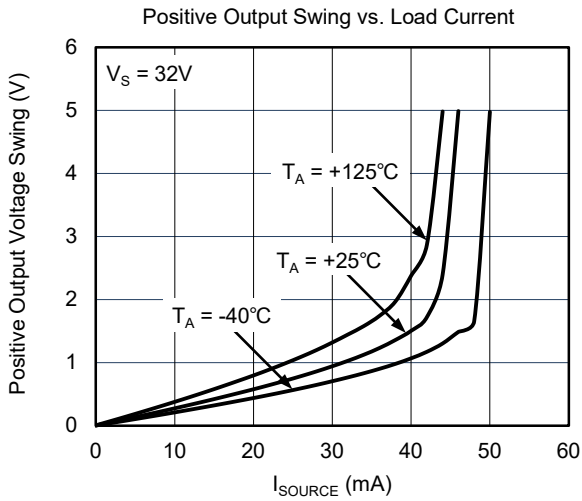
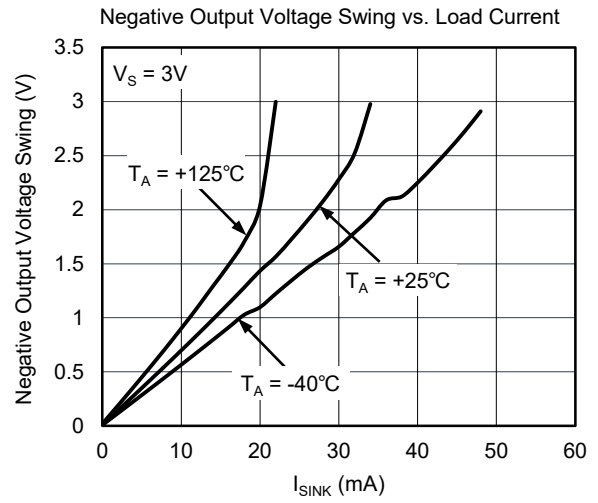
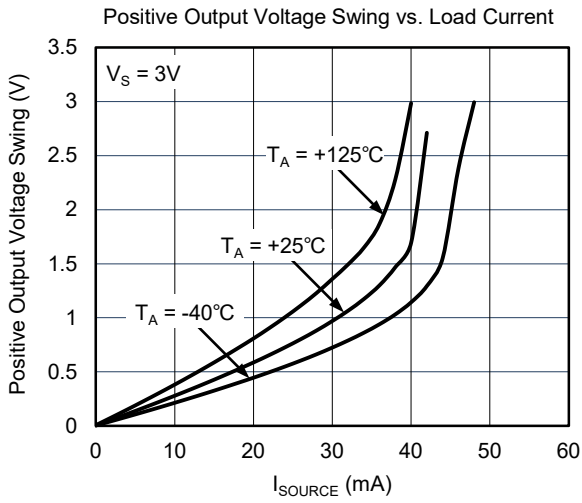

TYPICAL PERFORMANCE CHARACTERISTICS (continued)

At $T_A = +25^\circ\text{C}$, $V_{CM} = V_S/2$, unless otherwise noted.

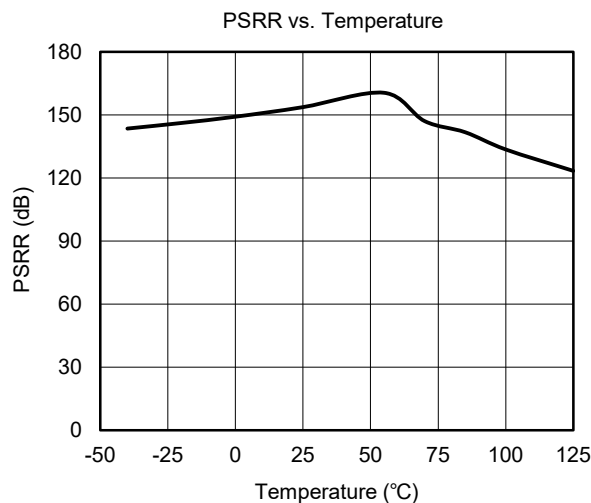
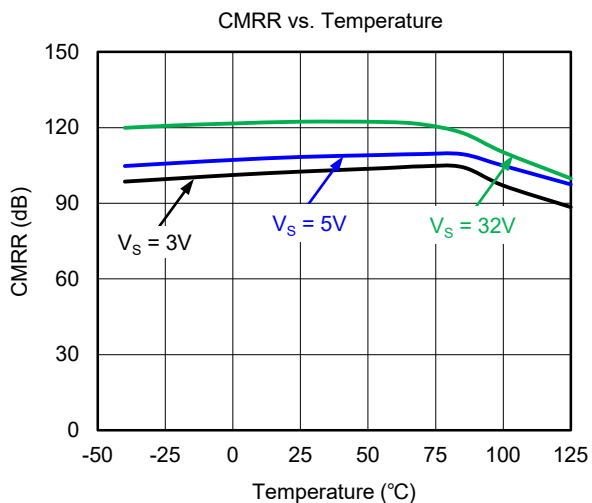
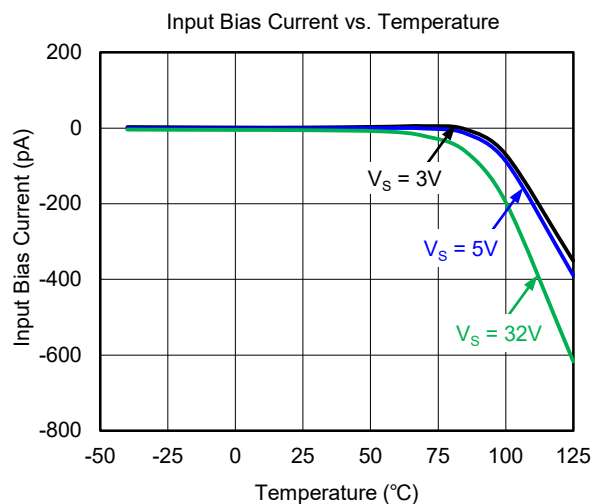
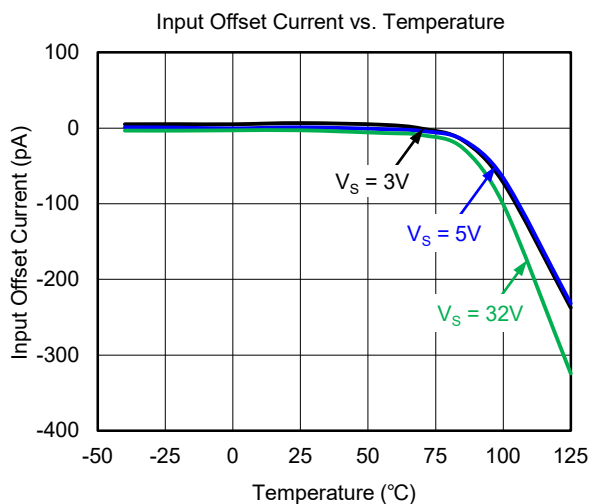
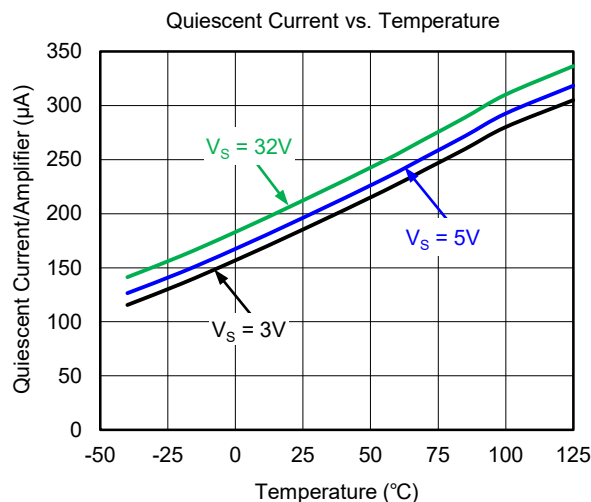
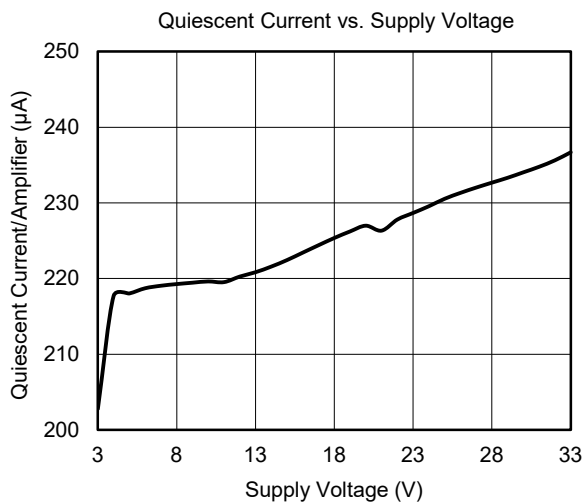

TYPICAL PERFORMANCE CHARACTERISTICS (continued)

At $T_A = +25^\circ\text{C}$, $V_{CM} = V_S/2$, unless otherwise noted.

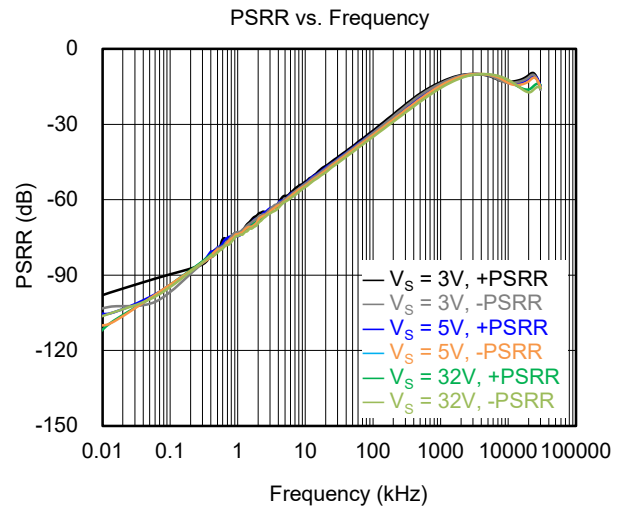
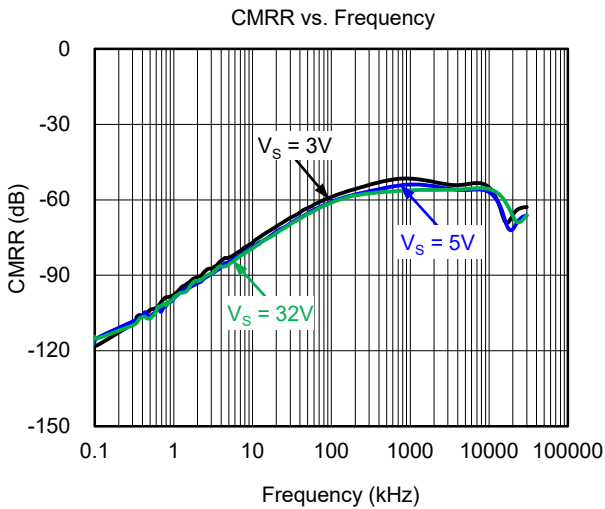
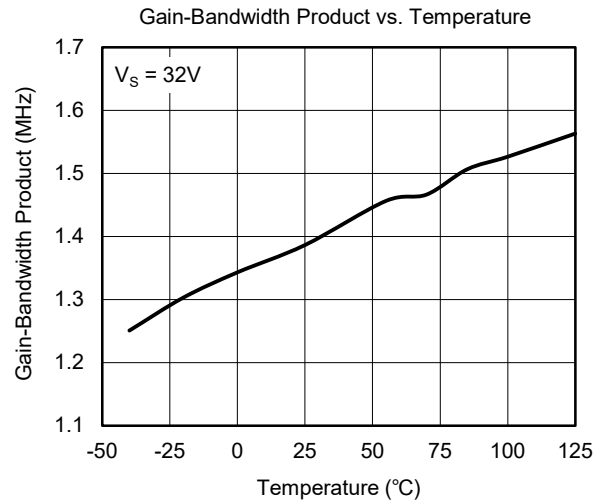
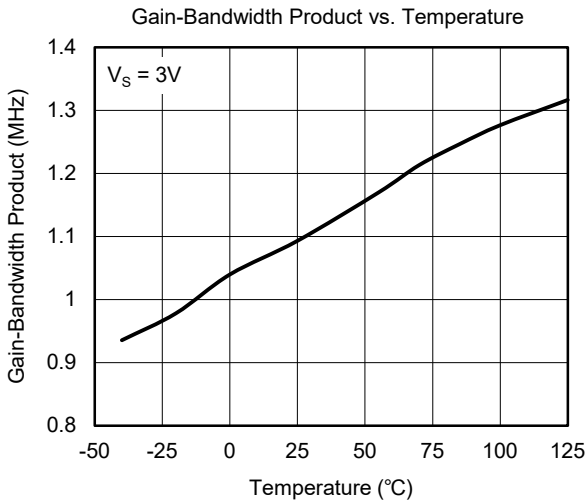
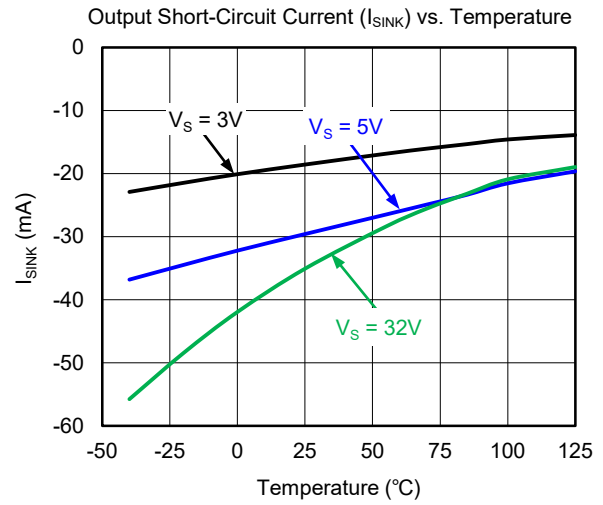
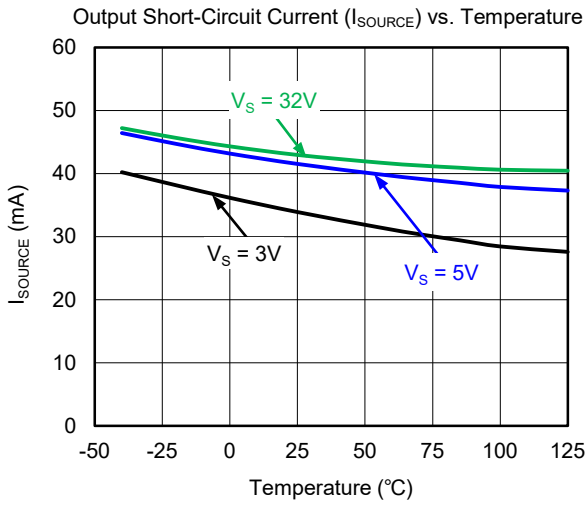

TYPICAL PERFORMANCE CHARACTERISTICS (continued)

At $T_A = +25^\circ\text{C}$, $V_{CM} = V_S/2$, unless otherwise noted.

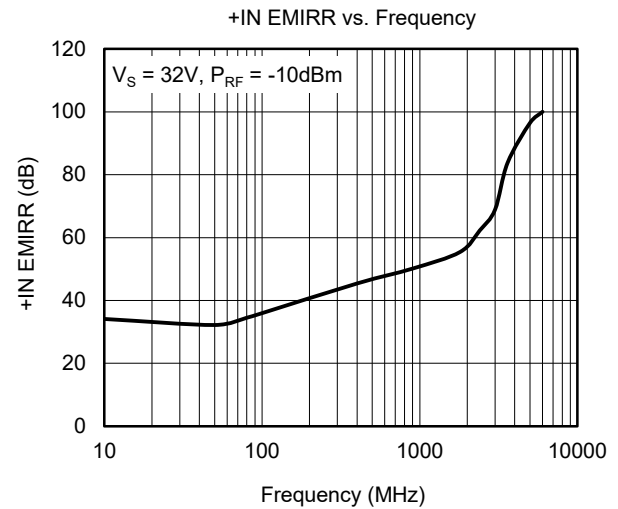
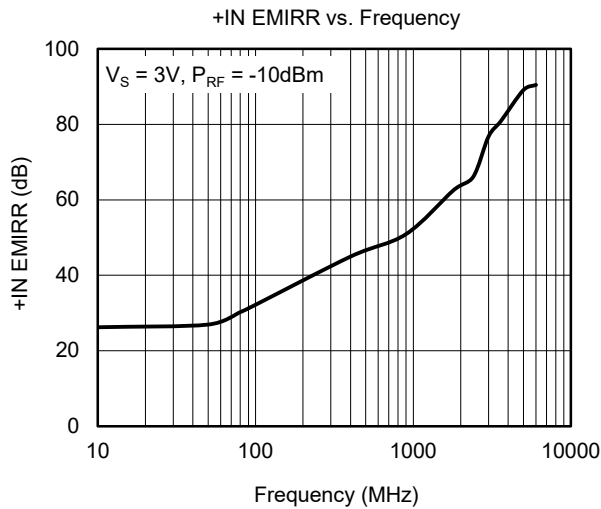
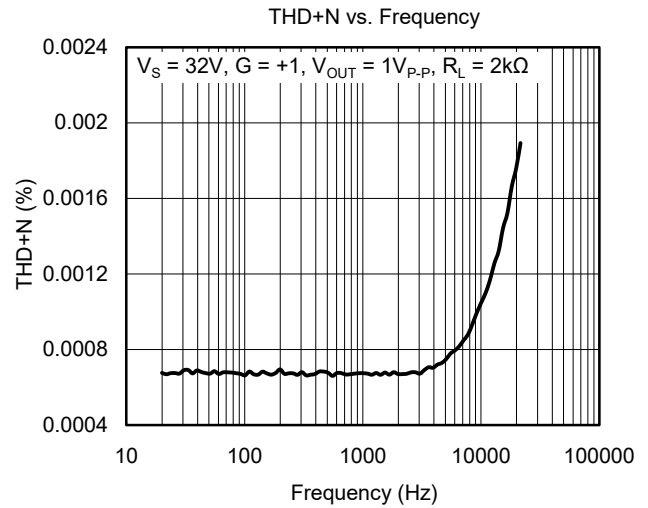
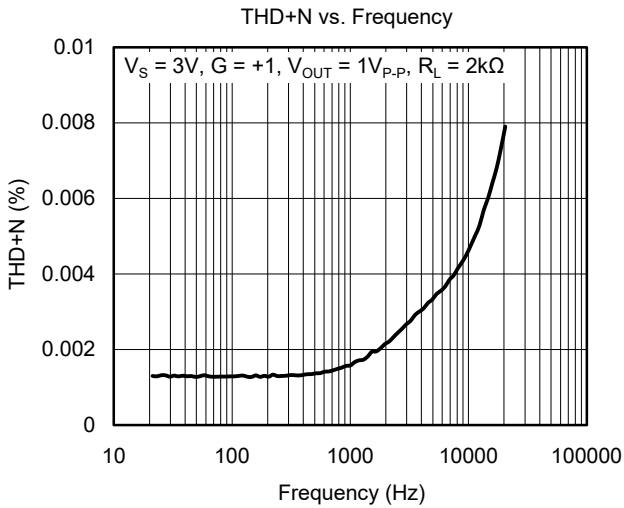
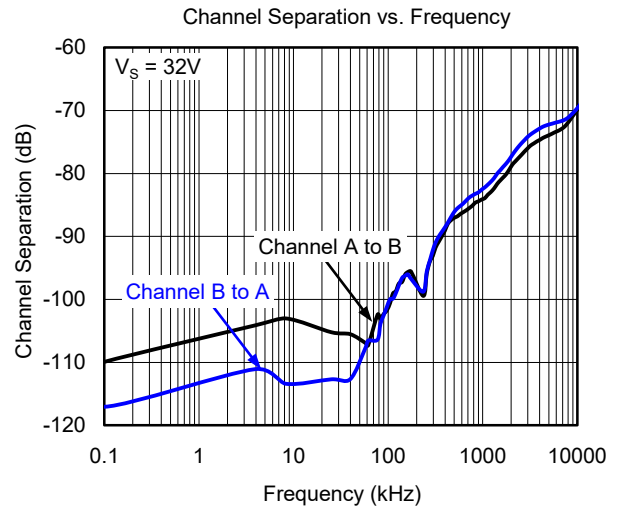
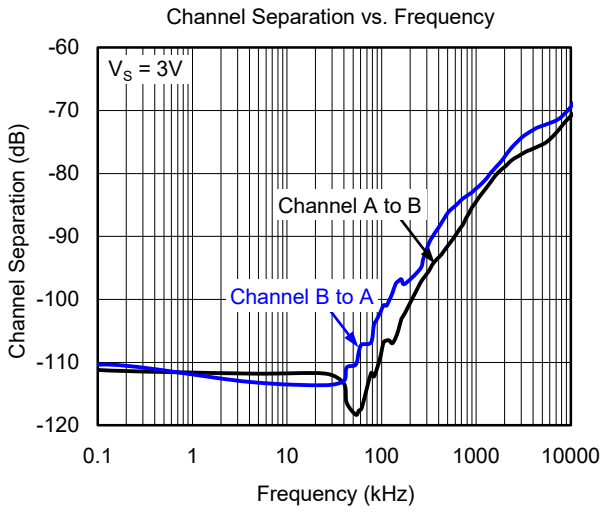

TYPICAL PERFORMANCE CHARACTERISTICS (continued)

At $T_A = +25^\circ\text{C}$, $V_{CM} = V_S/2$, unless otherwise noted.

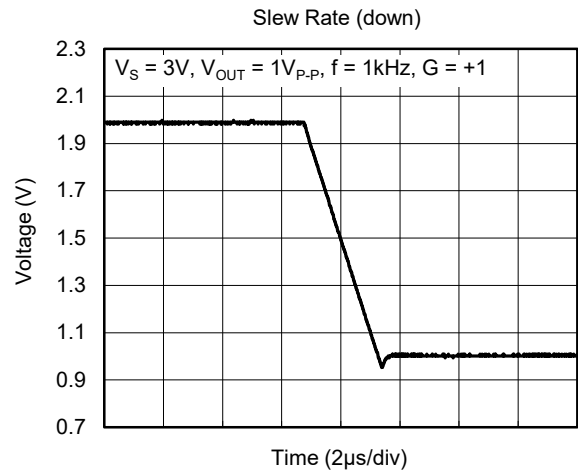
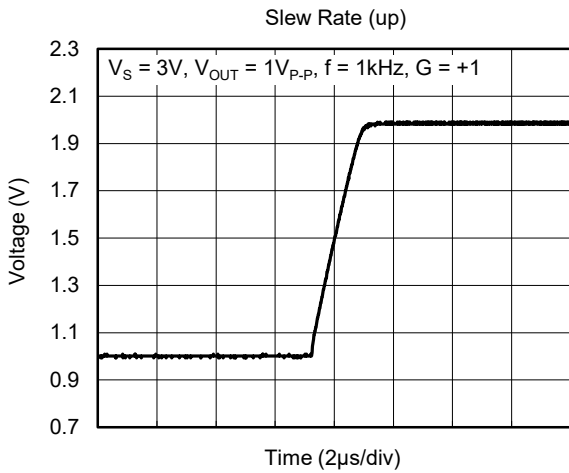
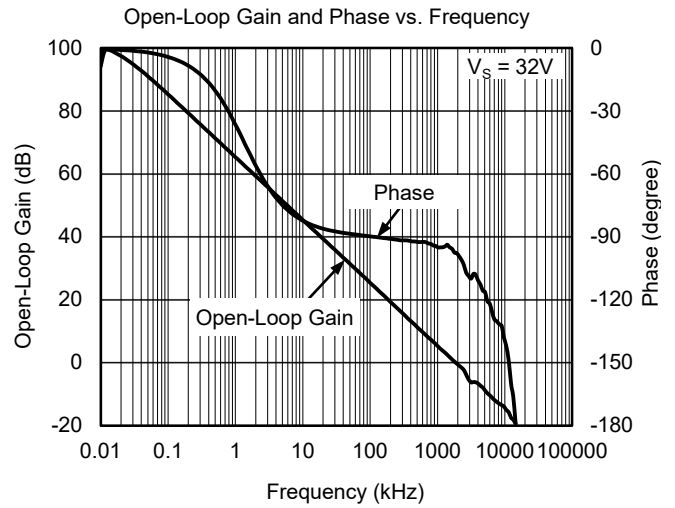
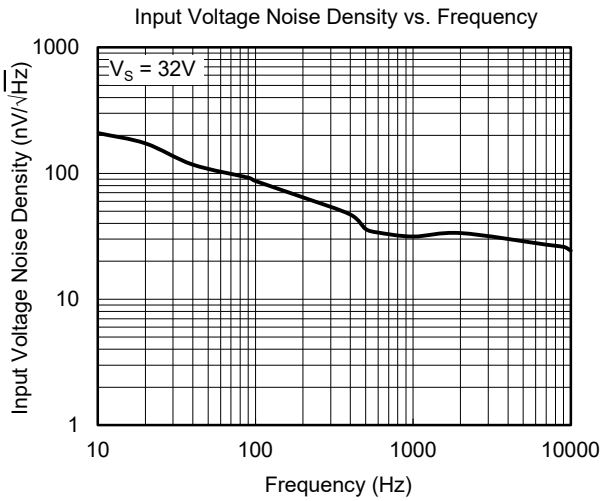
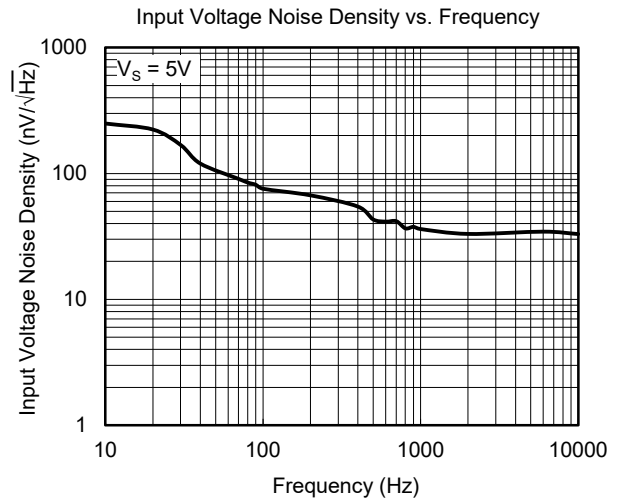
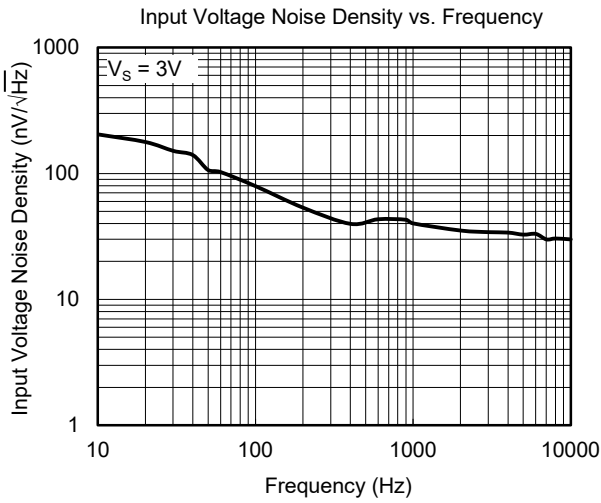

TYPICAL PERFORMANCE CHARACTERISTICS (continued)

At $T_A = +25^\circ\text{C}$, $V_{CM} = V_S/2$, unless otherwise noted.

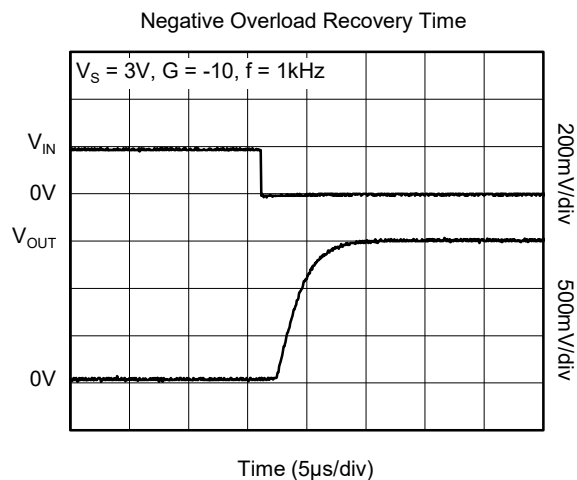
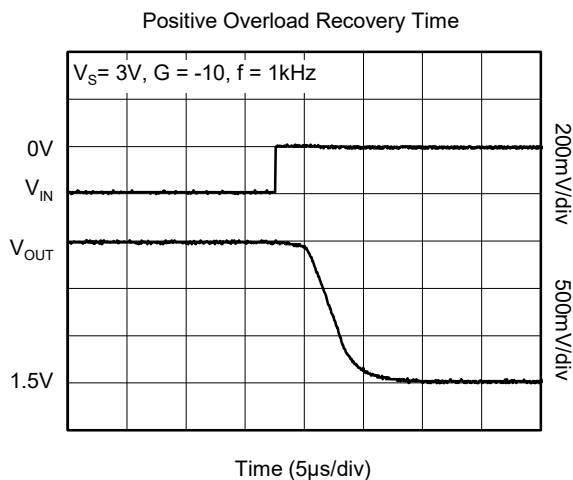
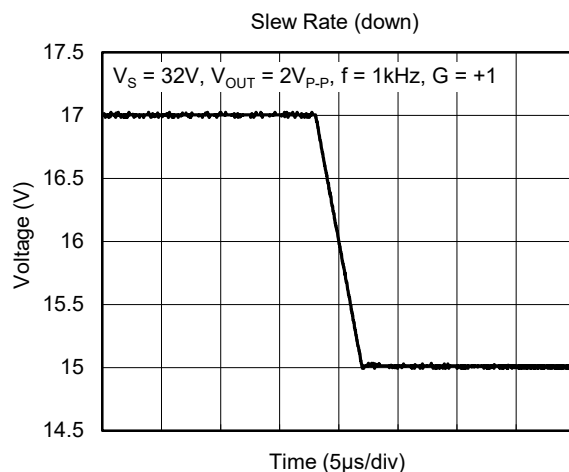
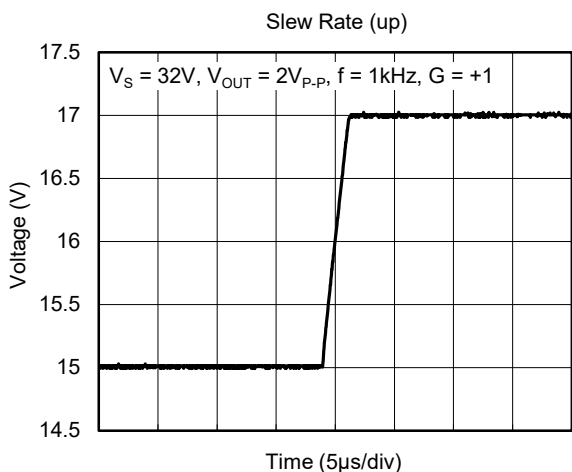
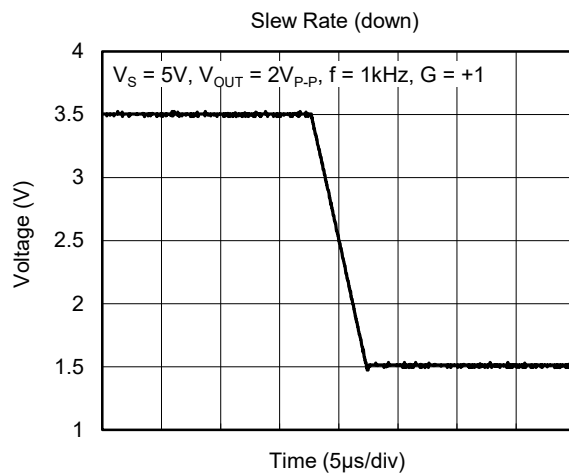
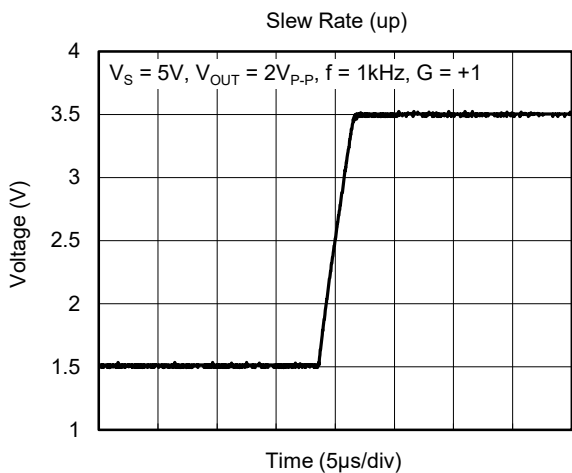

TYPICAL PERFORMANCE CHARACTERISTICS (continued)

At $T_A = +25^\circ\text{C}$, $V_{CM} = V_S/2$, unless otherwise noted.

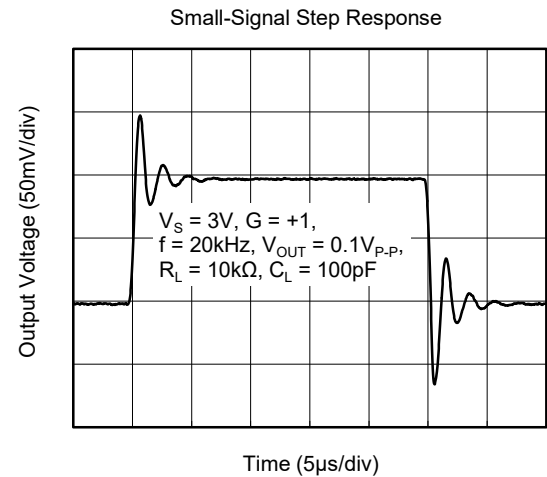
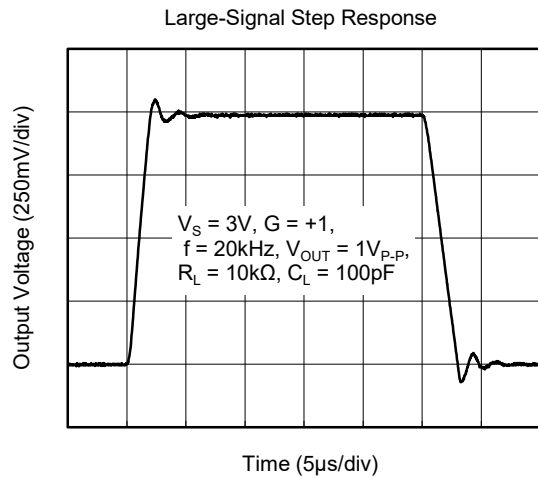
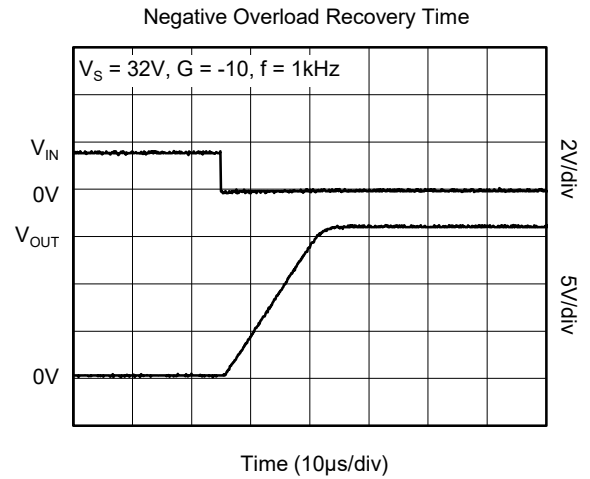
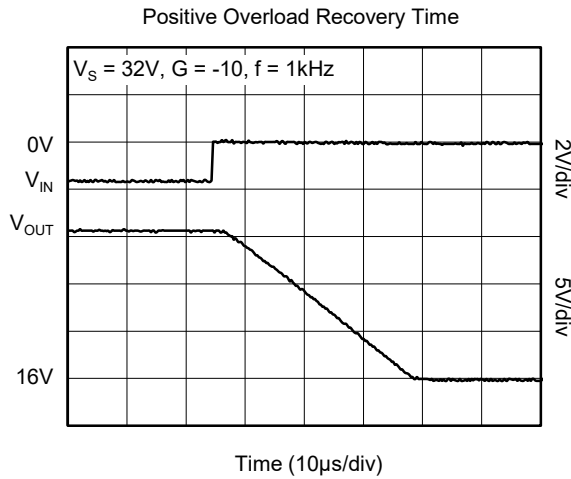
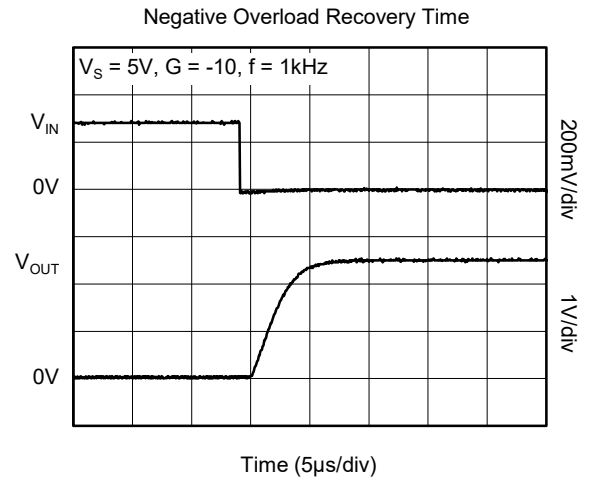
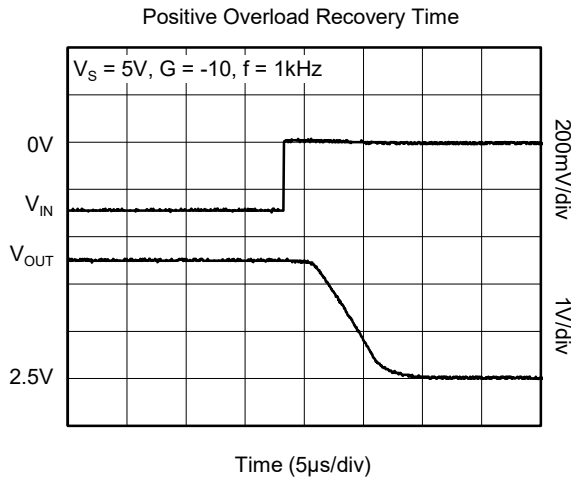

TYPICAL PERFORMANCE CHARACTERISTICS (continued)

At $T_A = +25^\circ\text{C}$, $V_{CM} = V_S/2$, unless otherwise noted.

Large-Signal Step Response

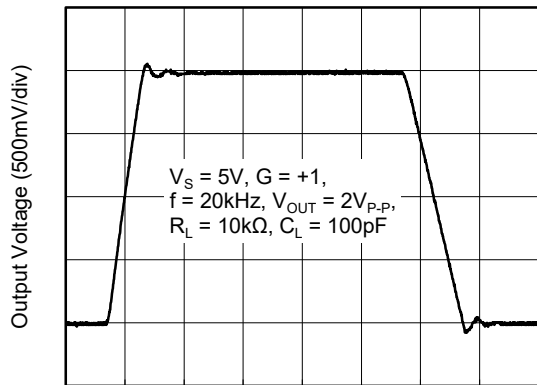

Time (5µs/div)

Small-Signal Step Response

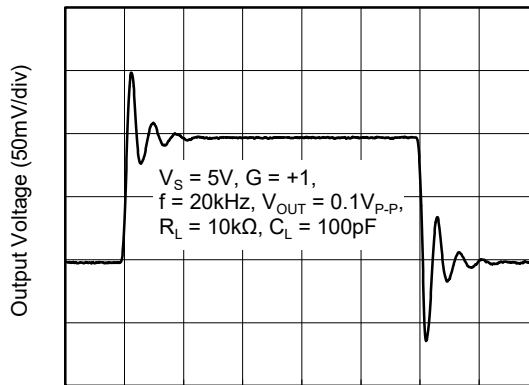

Time (5µs/div)

Large-Signal Step Response

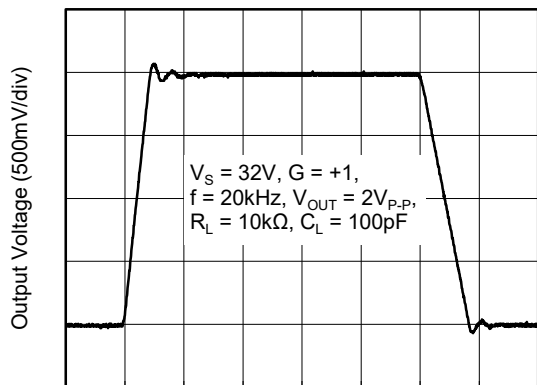

Time (5µs/div)

Small-Signal Step Response

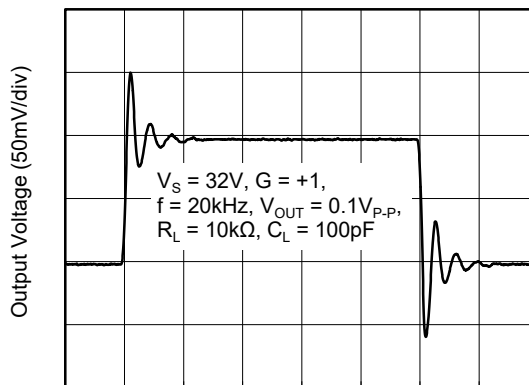

Time (5µs/div)

Turn-On Time

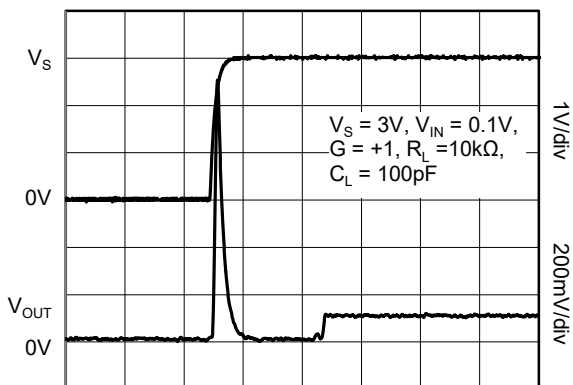

Time (20µs/div)

Turn-On Time

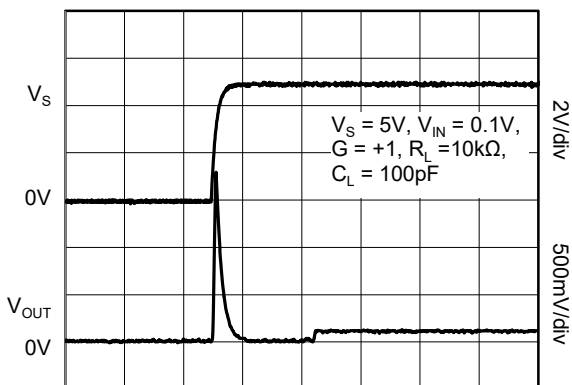

Time (20µs/div)

TYPICAL PERFORMANCE CHARACTERISTICS (continued)

At $T_A = +25^\circ\text{C}$, $V_{CM} = V_S/2$, unless otherwise noted.

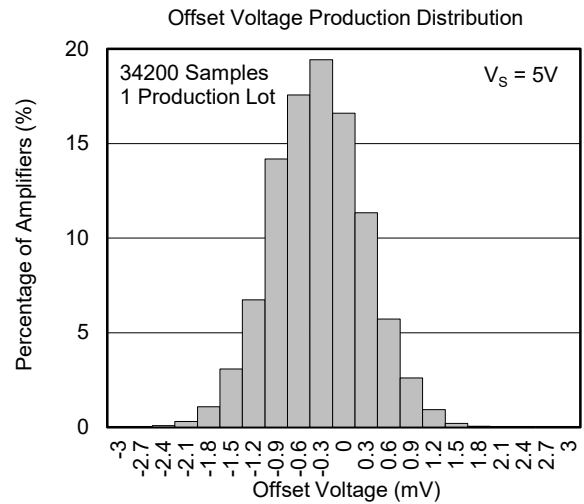
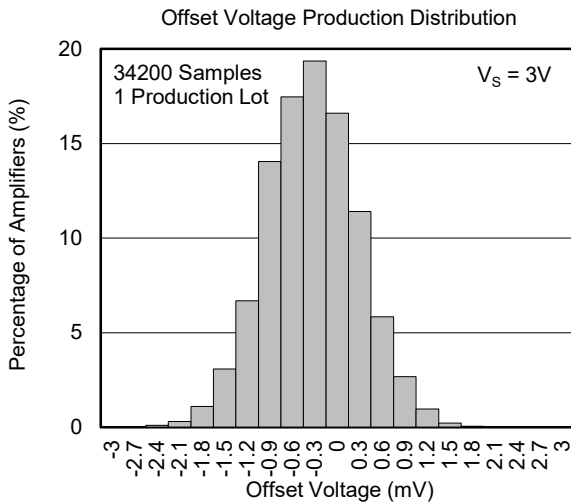
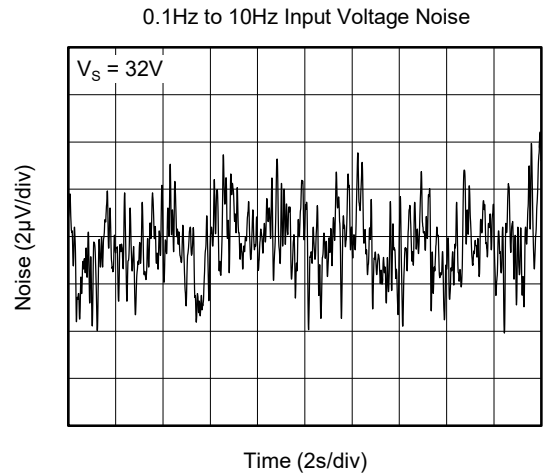
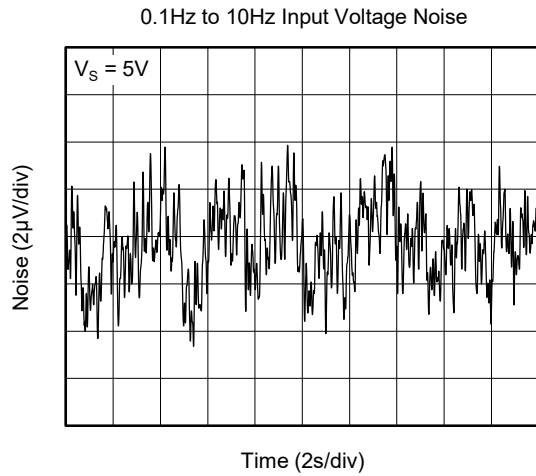
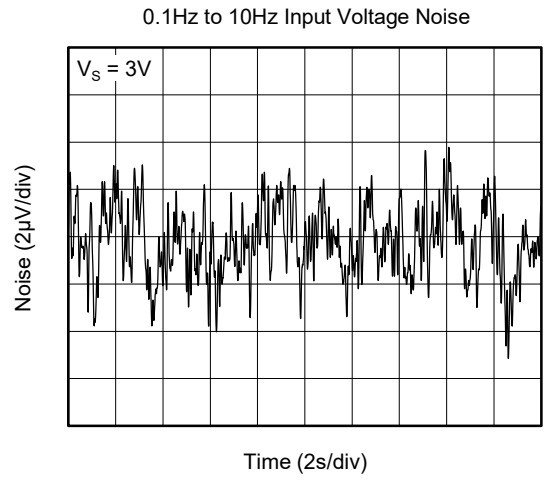
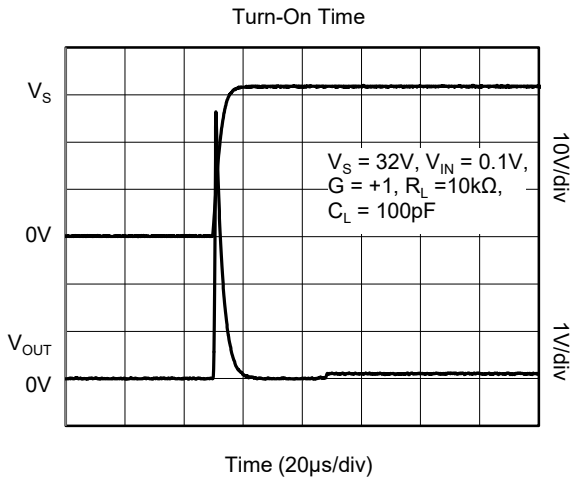

TYPICAL PERFORMANCE CHARACTERISTICS (continued)

At $T_A = +25^\circ\text{C}$, $V_{CM} = V_S/2$, unless otherwise noted.

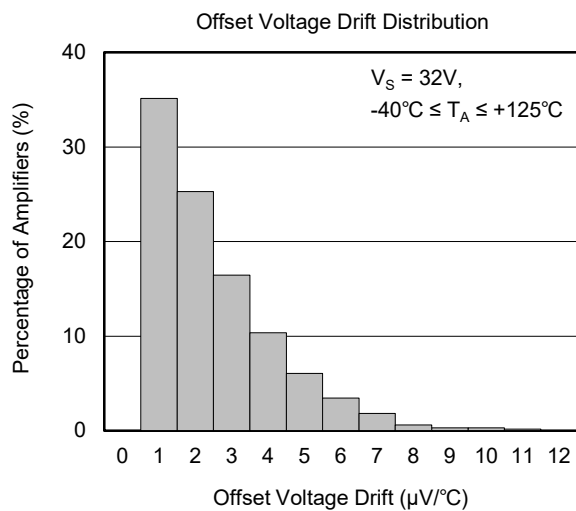
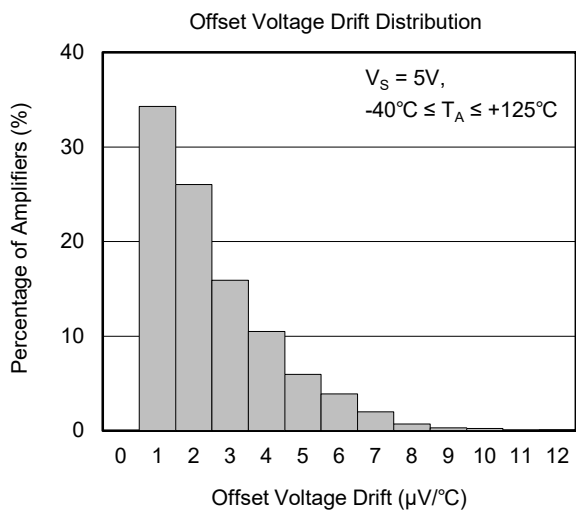
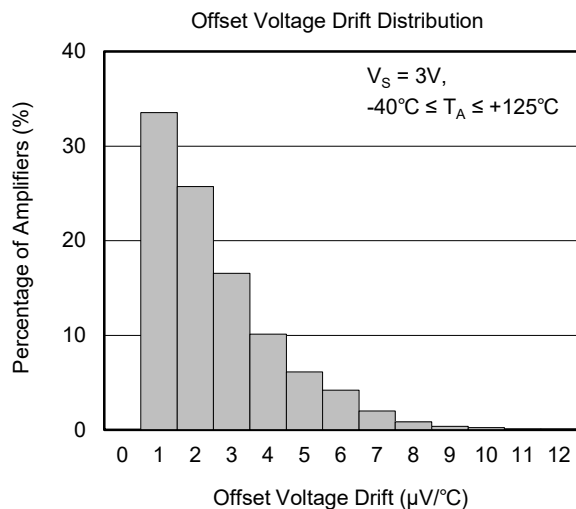
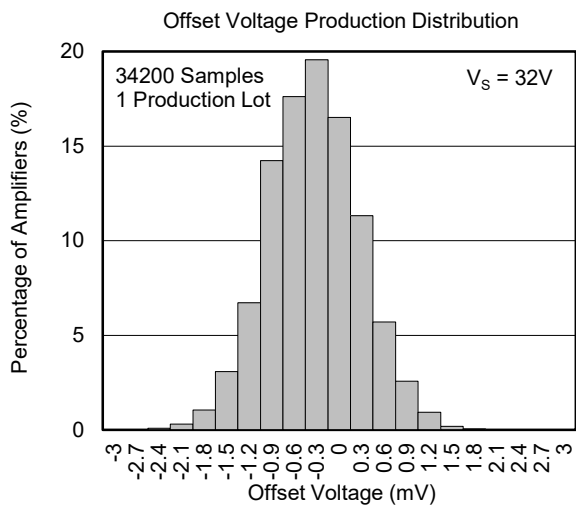

DETAILED DESCRIPTION

The LM2904 consists of two independent, high-gain frequency-compensated operational amplifiers designed to operate from a single supply over a wide range of voltages. Operation from dual supplies is also possible if the difference between the two supplies is 3V to 32V, and V_S is at least 1.5V more positive than the input common mode voltage.

Applications include transducer amplifiers, DC amplification blocks, and all the conventional operational amplifier circuits that now can be implemented more easily in single-supply-voltage systems. For example, the device can be operated directly from the standard 5V supply used in digital systems and can easily provide the required interface electronics without additional $\pm 5V$ supplies.

Unity-Gain Bandwidth

The unity-gain bandwidth is the frequency up to which an amplifier with a unity gain may be operated without greatly distorting the signal. The device has a 1.1MHz unity-gain bandwidth.

APPLICATION INFORMATION

The LM2904 operational amplifier is useful in a wide range of signal conditioning applications. Inputs can be powered before V_S for flexibility in multiple supply circuits.

Typical Application

A typical application for an operational amplifier is an inverting amplifier. This amplifier takes a positive voltage on the input and makes it a negative voltage of the same magnitude. In the same manner, it also makes negative voltages positive.

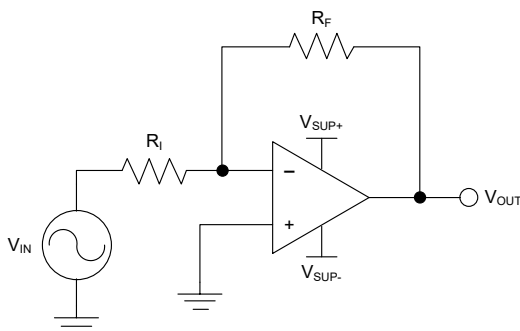

Figure 1. Application Schematic

Slew Rate

The slew rate is the rate at which an operational amplifier can change its output when there is a change on the input. The device has a 0.35V/ μ s slew rate.

Input Common Mode Range

The valid common mode voltage range is from device ground to $V_S - 1.5V$. Inputs may exceed V_S up to the maximum V_S without device damage. At least one input must be in the valid input common mode voltage range for output to be correct phase. If both inputs exceed valid range then output phase is undefined. If either input is less than $-0.3V$ then input current should be limited to 1mA and output phase is undefined.

Device Functional Modes

The device is powered on when the supply is connected. This device can be operated as a single-supply operational amplifier or dual-supply amplifier depending on the application.

The supply voltage must be chosen such that it is larger than the input voltage range and output range. For instance, this application will scale a signal of $\pm 0.5V$ to $\pm 1.8V$. Setting the supply at $\pm 12V$ is sufficient to accommodate this application.

Determine the gain required by the inverting amplifier using Equation 1 and Equation 2:

$$A_V = \frac{V_{OUT}}{V_{IN}} \quad (1)$$

$$A_V = \frac{1.8}{-0.5} = -3.6 \quad (2)$$

Once the desired gain is determined, choose a value for R_I or R_F . Choosing a value in the k Ω range is desirable because the amplifier circuit will use currents in the milliamp range. This ensures the part will not draw too much current. This example will choose 10k Ω for R_I which means 36k Ω will be used for R_F . This was determined by Equation 3.

$$A_V = -\frac{R_F}{R_I} \quad (3)$$

PACKAGE INFORMATION

PACKAGE OUTLINE DIMENSIONS

SOIC-8

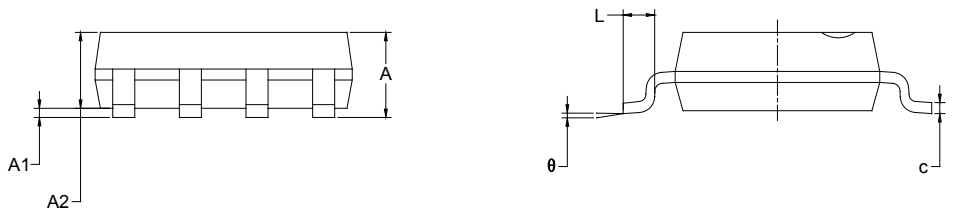
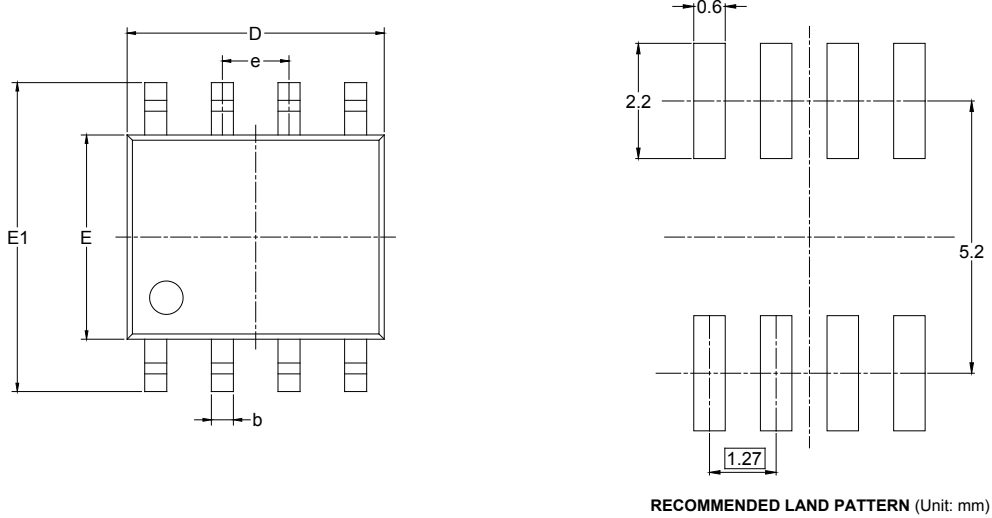

| Symbol | Dimensions In Millimeters | | Dimensions In Inches | |
|--------|------------------------------|-------|-------------------------|-------|
| | MIN | MAX | MIN | MAX |
| A | 1.350 | 1.750 | 0.053 | 0.069 |
| A1 | 0.100 | 0.250 | 0.004 | 0.010 |
| A2 | 1.350 | 1.550 | 0.053 | 0.061 |
| b | 0.330 | 0.510 | 0.013 | 0.020 |
| c | 0.170 | 0.250 | 0.006 | 0.010 |
| D | 4.700 | 5.100 | 0.185 | 0.200 |
| E | 3.800 | 4.000 | 0.150 | 0.157 |
| E1 | 5.800 | 6.200 | 0.228 | 0.244 |
| e | 1.27 BSC | | 0.050 BSC | |
| L | 0.400 | 1.270 | 0.016 | 0.050 |
| θ | 0° | 8° | 0° | 8° |

PACKAGE OUTLINE DIMENSIONS

MSOP-8



RECOMMENDED LAND PATTERN (Unit: mm)

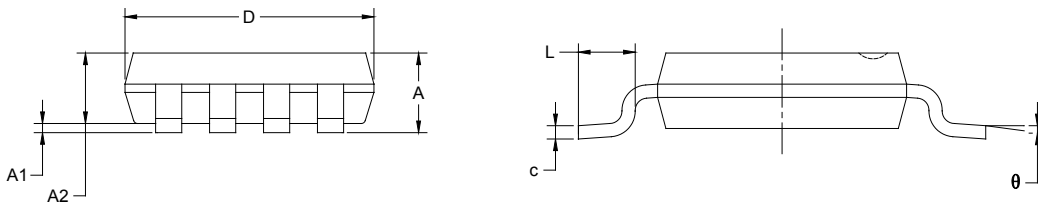

| Symbol | Dimensions In Millimeters | | Dimensions In Inches | |
|--------|------------------------------|-------|-------------------------|-------|
| | MIN | MAX | MIN | MAX |
| A | 0.820 | 1.100 | 0.032 | 0.043 |
| A1 | 0.020 | 0.150 | 0.001 | 0.006 |
| A2 | 0.750 | 0.950 | 0.030 | 0.037 |
| b | 0.250 | 0.380 | 0.010 | 0.015 |
| c | 0.090 | 0.230 | 0.004 | 0.009 |
| D | 2.900 | 3.100 | 0.114 | 0.122 |
| E | 2.900 | 3.100 | 0.114 | 0.122 |
| E1 | 4.750 | 5.050 | 0.187 | 0.199 |
| e | 0.650 BSC | | 0.026 BSC | |
| L | 0.400 | 0.800 | 0.016 | 0.031 |
| θ | 0° | 6° | 0° | 6° |

PACKAGE INFORMATION

PACKAGE OUTLINE DIMENSIONS

TSSOP-8

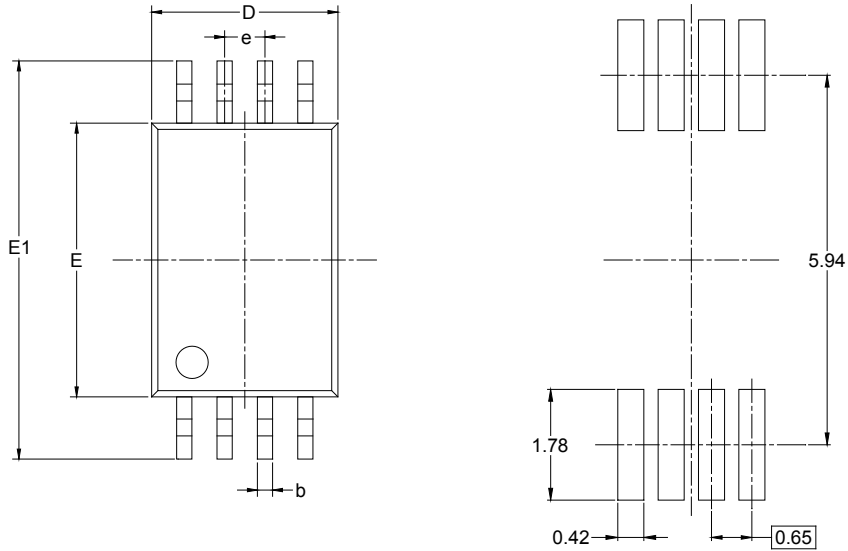

RECOMMENDED LAND PATTERN (Unit: mm)

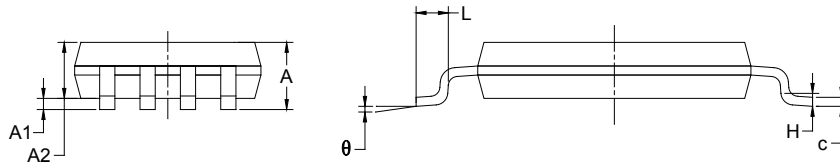

| Symbol | Dimensions In Millimeters | | Dimensions In Inches | |
|--------|------------------------------|-------|-------------------------|-------|
| | MIN | MAX | MIN | MAX |
| A | | 1.100 | | 0.043 |
| A1 | 0.050 | 0.150 | 0.002 | 0.006 |
| A2 | 0.800 | 1.000 | 0.031 | 0.039 |
| b | 0.190 | 0.300 | 0.007 | 0.012 |
| c | 0.090 | 0.200 | 0.004 | 0.008 |
| D | 2.900 | 3.100 | 0.114 | 0.122 |
| E | 4.300 | 4.500 | 0.169 | 0.177 |
| E1 | 6.250 | 6.550 | 0.246 | 0.258 |
| e | 0.650 BSC | | 0.026 BSC | |
| L | 0.500 | 0.700 | 0.02 | 0.028 |
| H | 0.25 TYP | | 0.01 TYP | |
| θ | 1° | 7° | 1° | 7° |

PACKAGE INFORMATION

TAPE AND REEL INFORMATION

REEL DIMENSIONS



TAPE DIMENSIONS



NOTE: The picture is only for reference. Please make the object as the standard.

KEY PARAMETER LIST OF TAPE AND REEL

| Package Type | Reel Diameter | Reel Width W1 (mm) | A0 (mm) | B0 (mm) | K0 (mm) | P0 (mm) | P1 (mm) | P2 (mm) | W (mm) | Pin1 Quadrant |
|--------------|---------------|--------------------|---------|---------|---------|---------|---------|---------|--------|---------------|
| SOIC-8 | 13" | 12.4 | 6.40 | 5.40 | 2.10 | 4.0 | 8.0 | 2.0 | 12.0 | Q1 |
| MSOP-8 | 13" | 12.4 | 5.20 | 3.30 | 1.50 | 4.0 | 8.0 | 2.0 | 12.0 | Q1 |
| TSSOP-8 | 13" | 12.4 | 6.76 | 3.30 | 1.80 | 4.0 | 8.0 | 2.0 | 12.0 | Q1 |

DD0001

PACKAGE INFORMATION

CARTON BOX DIMENSIONS



NOTE: The picture is only for reference. Please make the object as the standard.

KEY PARAMETER LIST OF CARTON BOX

| Reel Type | Length (mm) | Width (mm) | Height (mm) | Pizza/Carton |
|-----------|-------------|------------|-------------|--------------|
| 13" | 386 | 280 | 370 | 5 |

DD0002