

# RS7100

## Low Power 300mA CMOS LDO

### General Description

The RS7100 is a low-dropout linear regulator that operations in the input voltage range from +2.5V to +9.0V and delivers 300mA output current. The high-accuracy output voltage is preset at an internally trimmed voltage 2.5V or 3.3V. Other output voltages can be mask-optional from 1.5V to 5.0V with 100mV increment.

The RS7100 consists of a 1.25V bandgap reference, an error amplifier, and a P-channel pass transistor. Other features include short-circuit protection and thermal shutdown protection. The RS7100 devices are available in SOT-23 and SOT-89 packages.

### Features

- Operating Voltages Range: +2.5V to +9.0V
- Output Voltages Range: +1.5V to +5.0V with 100mV Increment
- Maximum Output Current: 300mA
- Low Dropout: 120mV@100mA ( $V_{OUT} \geq 2.0V$ )
- $\pm 2\%$  Output Voltage Accuracy
- High Ripple Rejection: 70dB
- Output Current Limit Protection (600mA)
- Short Circuit Protection (300mA)
- Thermal Overload Shutdown Protection
- Low ESR Capacitor Compatible
- RoHS Compliant and 100% Lead (Pb)-Free and Green (Halogen Free with Commercial Standard)

### Applications

- Battery-powered equipment
- Voltage regulator for microprocessor
- Voltage regulator for LAN cards
- Wireless Communication equipment
- Audio/Video equipment
- Post Regulator for Switching Power

### Application Circuits

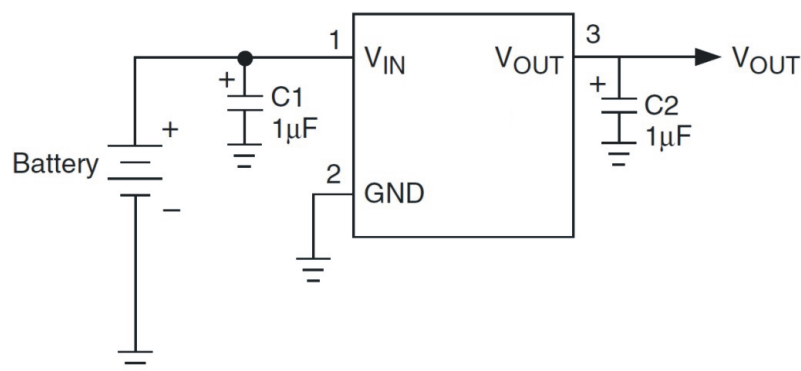

## Pin Assignments

**SOT-23**

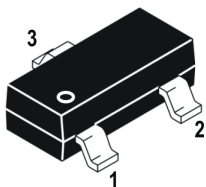

**SOT-89**

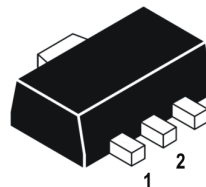

PACKAGE	PIN	SYMBOL	DESCRIPTION
SOT-23	1	GND	Ground Pin
	2	VOUT	Regulator Output Pin
	3	VIN	Regulator Input Pin

PACKAGE	PIN	SYMBOL	DESCRIPTION
SOT-89	1	GND	Ground Pin
	2	VOUT	Regulator Output Pin
	3	VIN	Regulator Input Pin

## Ordering Information

DEVICE	DEVICE CODE
RS7100-XX Y Z	<p><b>XX</b> is nominal output voltage (for example, 15 = 1.5V, 33 = 3.3V, 285 = 2.85V).  <b>Y</b> is package designator :                      N: SOT-23                      M: SOT-89  <b>Z</b> is Lead Free designator :                      P: Commercial Standard, Lead (Pb) Free and Phosphorous (P) Free Package                      G: Green (Halogen Free with Commercial Standard)</p>

## Block Diagram

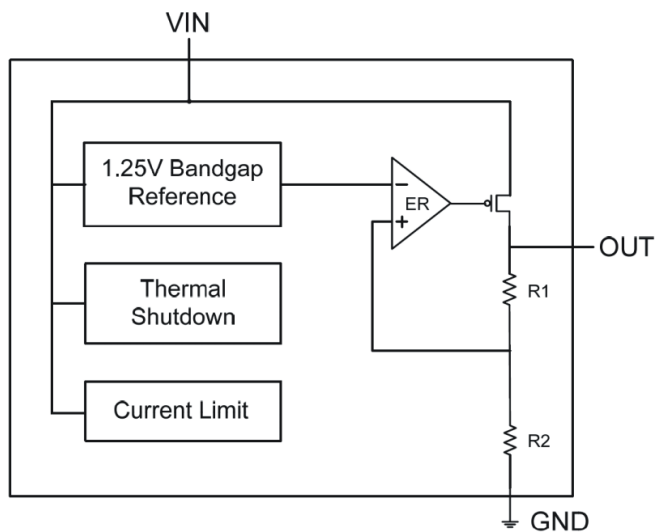

## Absolute Maximum Ratings

Parameter	Symbol	Ratings	Units
Input Voltage $V_{IN}$ to GND	$V_{IN}$	10	V
Output Current Limit, $I_{LIMIT}$	$I_{LIMIT}$	600	mA
Junction Temperature	$T_J$	+155	°C
Thermal Resistance	SOT-23	280	°C/W
	SOT-89	180	
Power Dissipation	SOT-23	350	mW
	SOT-89	550	
Operating Ambient Temperature	$T_{OPR}$	-40 ~ +85	°C
Storage Temperature	$T_{STG}$	-55~+150	°C
Lead Temperature (soldering, 10sec)	-	+260	°C

**NOTE:** Stresses beyond those listed under “absolute maximum ratings” may cause permanent damage to the device. These are stress ratings only, and function operation of the device at these or any other conditions beyond those indicated under “recommended operating conditions” is not implied. Exposure to absolute-maximum-rated conditions for extended periods may affect device reliability.

## Electrical Characteristics ( $T_A=25^\circ\text{C}$ , unless otherwise specified)

Symbol	Parameter	Conditions	Min.	Typ.	Max.	Unit
$V_{IN}$	Input Voltage	-	2.5	-	9.0	V
$V_{OUT}$	Output Voltage	$V_{IN}=V_{OUT}+0.48\text{V}$ , $I_{OUT}=1\text{mA}$ , $V_{OUT}\leq 7.0\text{V}$	-2%	$V_{OUT}$	+2%	V
		$V_{IN}=V_{OUT}+0.48\text{V}$ , $I_{OUT}=1\text{mA}$ , $7.0\text{V}<V_{IN}\leq 9.0\text{V}$				
$\Delta V_{OUT}$	Output Voltage Accuracy	$V_{IN}>V_{OUT}+0.48\text{V}$ , $V_{IN}\leq 7.0\text{V}$	-2%	$V_{OUT}$	+2%	V
		$V_{IN}>V_{OUT}+0.48\text{V}$ , $7.0\text{V}<V_{IN}\leq 9.0\text{V}$				
$I_{MAX}$	Output Current	-	300	-	-	mA
$I_{LIMIT}$	Current Limit	-	-	0.6	-	A
$I_{SC}$	Short Circuit Current	$V_{OUT}=0\text{V}$ , $V_{IN}=5\text{V}$	-	300	350	mA
$I_Q$	Ground Pin Current	$I_{LOAD}=0\text{mA}$ to $300\text{mA}$ , $V_{IN}=5.0\text{V}$	-	30	50	uA
$V_{DROP}$	Dropout Voltage	$I_{OUT}=100\text{mA}$	-	120	145	mV
		$I_{OUT}=300\text{mA}$	-	400	480	
$\Delta V_{LINE}$	Line Regulation	$V_{OUT}+0.48\text{V}<V_{IN}<9.0\text{V}$ , $I_{LOAD}=1\text{mA}$	-	0.2	0.3	%/V
$\Delta V_{LOAD}$	Load Regulation	$I_{OUT}=0\text{mA}$ to $300\text{mA}$	-	0.01	0.02	%/mA
$e_N$	Output Noise	$F=1\text{Hz}$ to $10\text{KHz}$ , $C_{OUT}=1\mu\text{F}$	-	70	-	$\mu\text{V}_{(rms)}$
PSRR	Ripple Rejection	$F=1\text{KHz}$ , $C_{OUT}=1\mu\text{F}$	-	70	-	dB
$T_{SD}$	Thermal Shutdown Temperature	-	-	160	-	°C
$T_{HYS}$	Thermal Shutdown Hysteresis	-	-	10	-	°C

## Typical Operating Characteristics

( $C_{IN}=1\mu F$ ,  $C_{OUT}=3.3\mu F$ ,  $T_A=+25^\circ C$ , unless otherwise noted.)

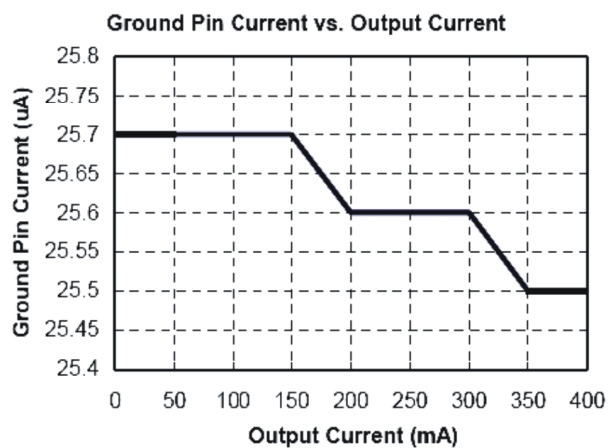
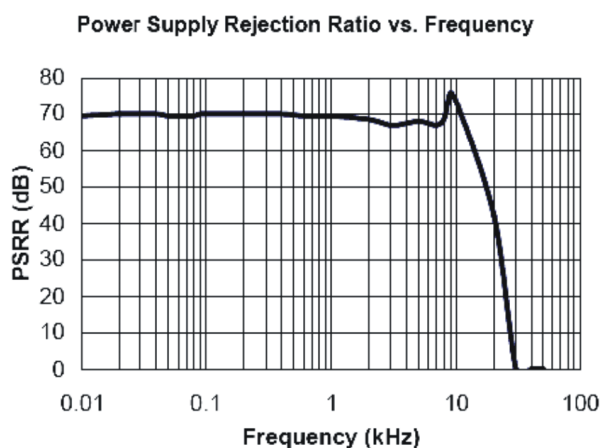
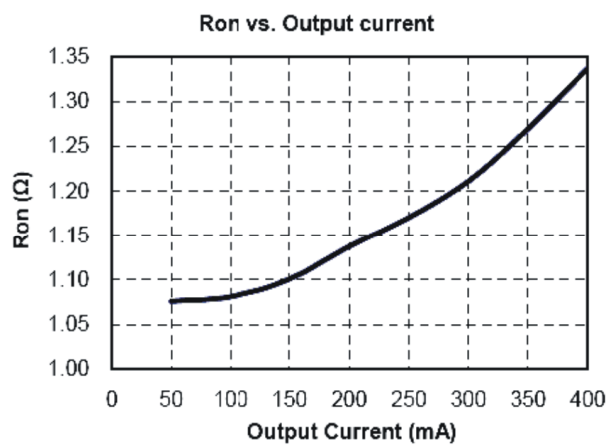
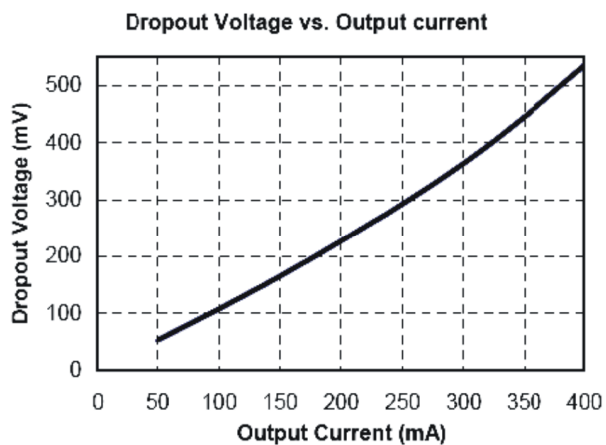
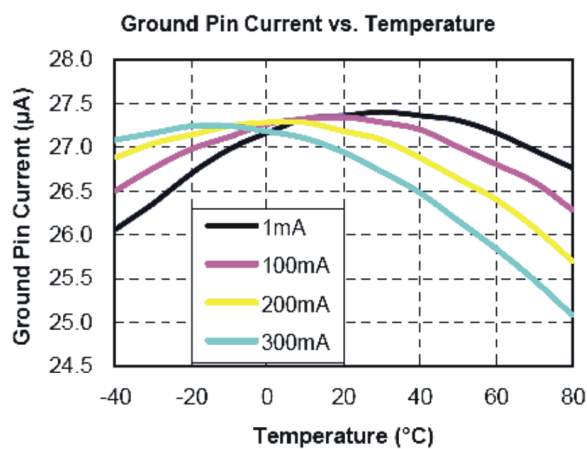
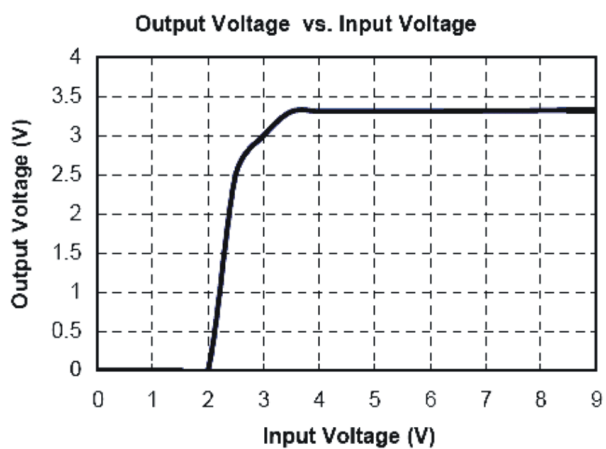

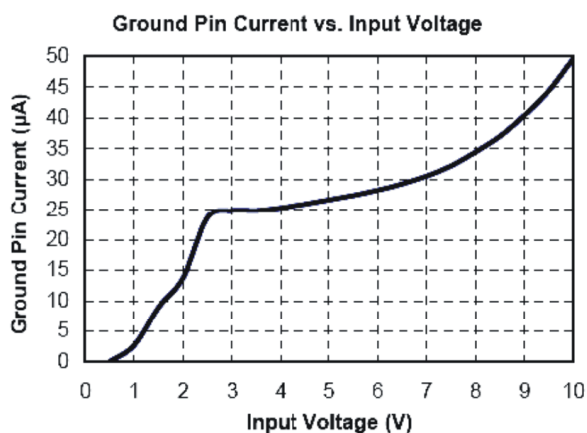
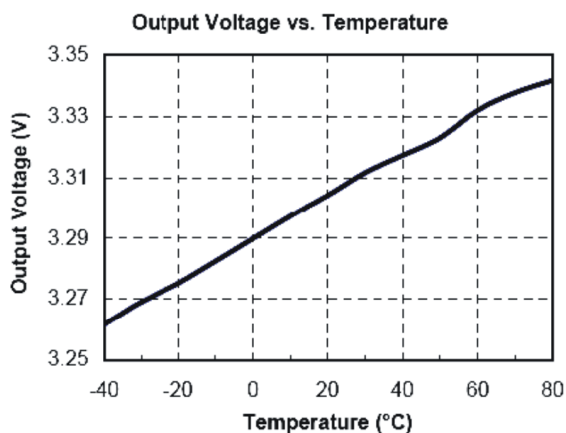

Output Noise DC to 1MHz (60.9µVRMS), IOUT=0mA

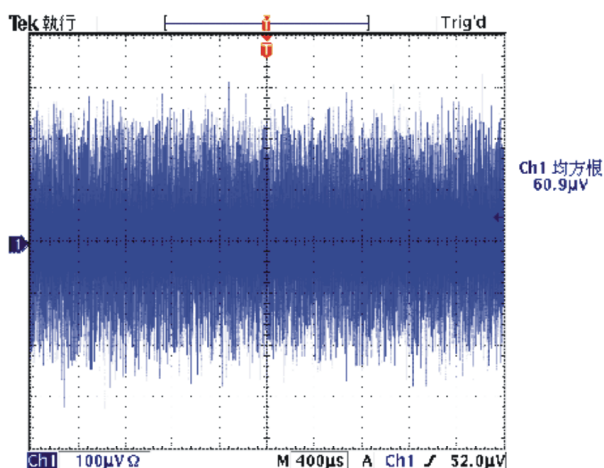

Output Noise DC to 1MHz (371µVRMS), IOUT=300mA

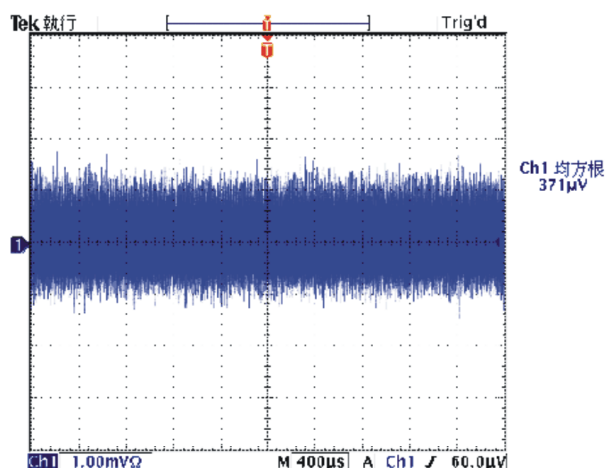

Line Transient (IOUT=1mA, VIN=4V-5V)

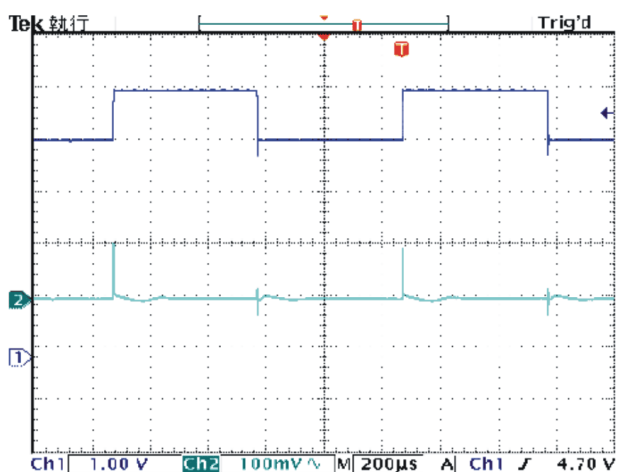

Line Transient (IOUT=10mA, VIN=4V-5V)

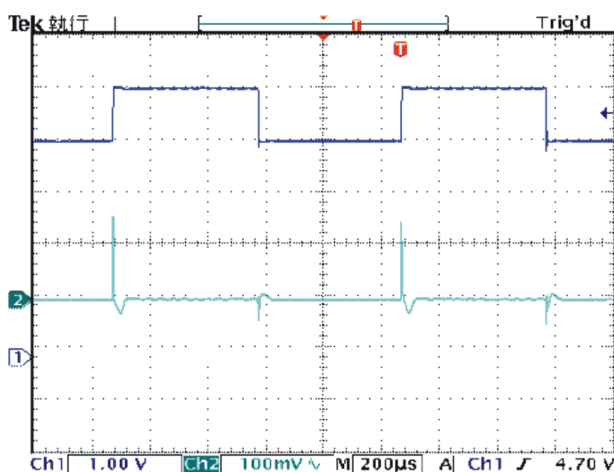

Line Transient (I<sub>OUT</sub>=100mA, V<sub>IN</sub>=4V-5V)

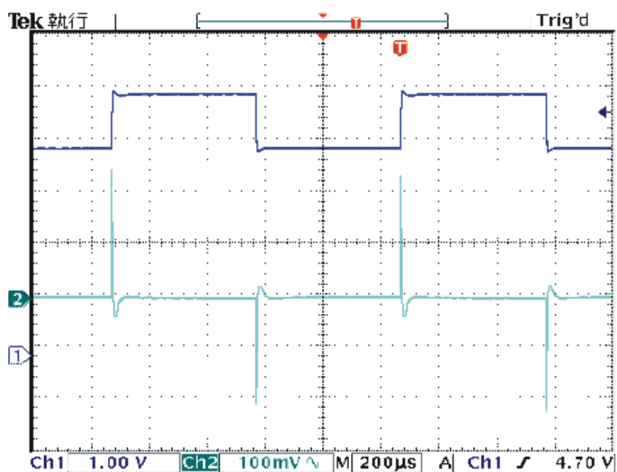

Line Transient (I<sub>OUT</sub>=200mA, V<sub>IN</sub>=4V-5V)

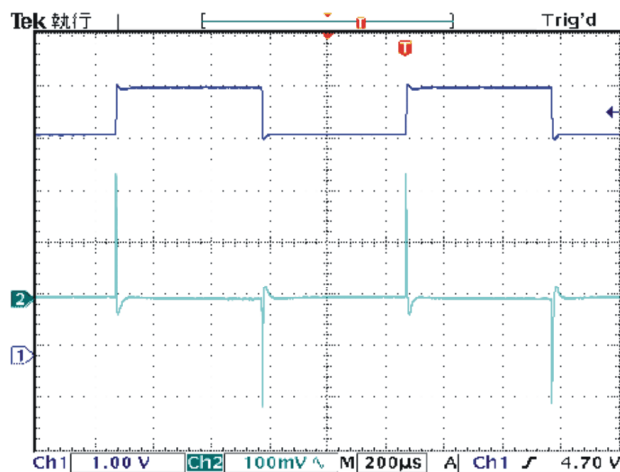

Load Transient (I<sub>OUT</sub>=1mA-100mA)

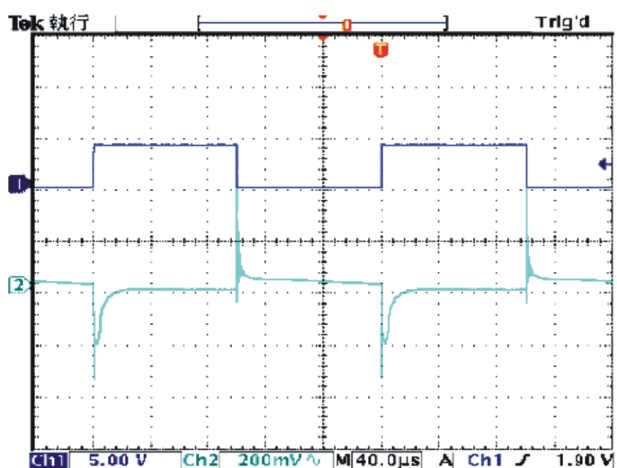

Load Transient (I<sub>OUT</sub>=100mA-200mA)

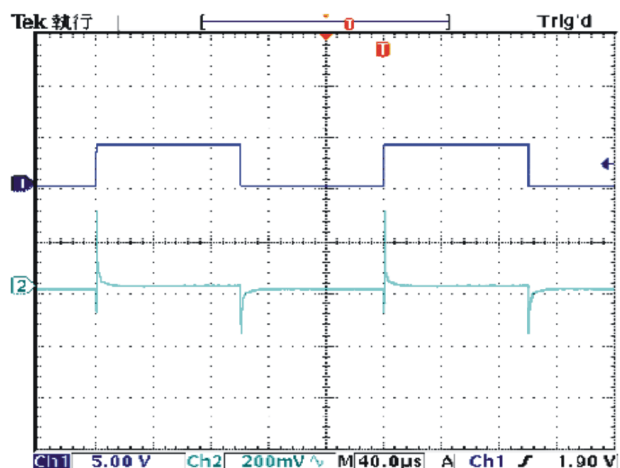

Load Transient (I<sub>OUT</sub>=200mA-300mA)

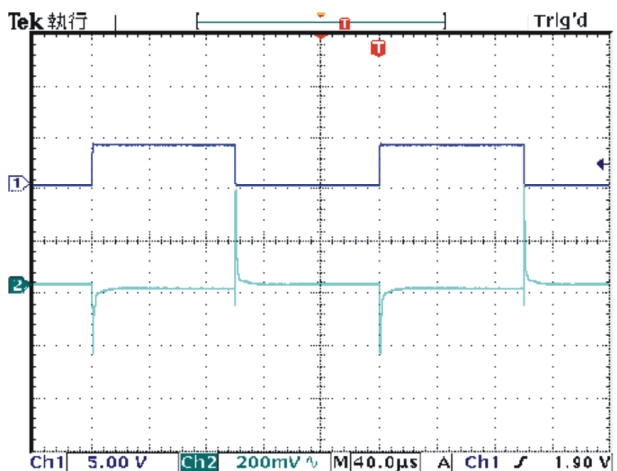

Load Transient (I<sub>OUT</sub>=1mA-300mA)

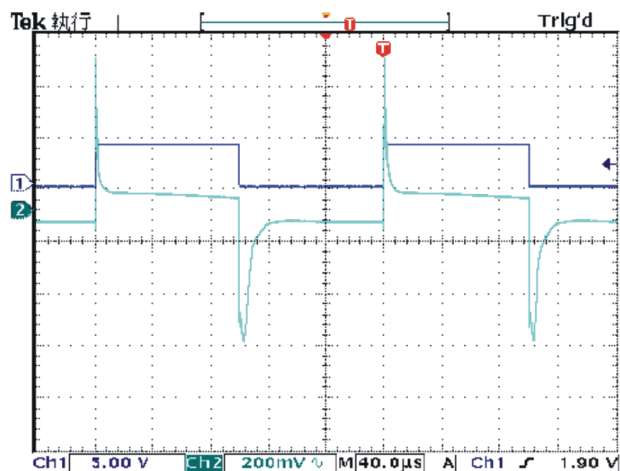

## Detail Description

The RS7100 is a low-dropout linear regulator. The device provides preset 2.5V and 3.3V output voltages for output current up to 300mA. Other mask options for special output voltages from 1.5V to 5.0V with 100mV increment are also available. As illustrated in function block diagram, it consists of a 1.25V reference, error amplifier, a P-channel pass transistor, and an internal feedback voltage divider.

The 1.25V bandgap reference is connected to the error amplifier, which compares this reference with the feedback voltage and amplifies the voltage difference. If the feedback voltage is lower than the reference voltage, the pass-transistor gate is pulled lower, which allows more current to pass to the output pin and increases the output voltage. If the feedback voltage is too high, the pass-transistor gate is pulled up to decrease the output voltage.

The output voltage is feedback through an internal resistive divider connected to V<sub>OUT</sub> pin. Additional blocks include with output current limiter and shutdown logic.

### Internal P-channel Pass Transistor

The RS7100 features a P-channel MOSFET pass transistor. Unlike similar designs using PNP pass transistors, P-channel MOSFETs require no base drive, which reduces quiescent current. PNP-based regulators also waste considerable current in dropout conditions when the pass transistor saturates, and use high base-drive currents under large loads. The RS7100 does not suffer from these problems and consumes only 65μA (Typical) of ground pin current under heavy loads as well as in dropout conditions.

### Output Voltage Selection

The RS7100 output voltage is preset at an internally trimmed voltage 2.5V or 3.3V or can be mask optioned from 1.5V to 5.0V with 100mV increment. The first two digits of part number suffix identify the output voltage (see Ordering Information). For example, RS7100-33 has a preset 3.3V output voltage.

### Current Limit

The RS7100 also includes a fold back current limiter. It monitors and controls the pass-transistor's gate voltage, estimates the output current, and limits the output current within 600mA.

### Thermal Overload Protection

Thermal overload protection limits total power dissipation in the RS7100. When the junction temperature exceeds T<sub>J</sub>=+155°C, a thermal sensor turns off the pass transistor, allowing the IC to cool down. The thermal sensor turns the pass transistor active again after the junction temperature cools down by 20°C resulting in a pulsed output during continuous thermal overload conditions.

Thermal overload protection is designed to protect the RS7100 in the event of fault conditions. For continuous operation, the maximum operating junction temperature rating of T<sub>J</sub>=+125°C should not be exceeded.

### Operating Region and Power Dissipation

Maximum power dissipation of the RS7100 depends on the thermal resistance of the case and circuit board, the temperature difference between the die junction and ambient air, and the rate of airflow. The power dissipation across the devices is P = I<sub>OUT</sub> × (V<sub>IN</sub>-V<sub>OUT</sub>). The resulting maximum power dissipation is:

$$P_{MAX} = \frac{(T_J - T_A)}{\theta_{JC} + \theta_{CA}} = \frac{(T_J - T_A)}{\theta_{JA}}$$

Where (T<sub>J</sub>-T<sub>A</sub>) is the temperature difference between the RS7100 die junction and the surrounding air, θ<sub>JC</sub> is the thermal resistance of the package chosen, and θ<sub>CA</sub> is the thermal resistance through the printed circuit board, copper traces and other materials to the surrounding air. For better heat-sinking, the copper area should be equally shared between the V<sub>IN</sub>, V<sub>OUT</sub>, and GND pins.

If the RS7100 uses a SOT-89 package and this package is mounted on a double sided printed circuit board with two square inches of copper allocated for "heat spreading", the resulting θ<sub>JA</sub> is 180°C/W.

Based on a maximum operating junction temperature 125°C with an ambient of 25°C, the maximum power dissipation will be:

$$P_{\text{MAX}} = \frac{(T_J - T_A)}{\theta_{\text{JC}} + \theta_{\text{CA}}} = \frac{(125 - 25)}{180} = 0.555\text{W}$$

Thermal characteristics were measured using a double-side board with 1" x 2" square inches of copper area connected to the GND pin for "heat spreading".

### **Dropout Voltage**

A regulator's minimum input-output voltage differential, or dropout voltage, determines the lowest usable supply voltage. In battery-powered systems, this will determine the useful end-of-life battery voltage. The RS7100 uses a P-channel MOSFET pass transistor, its dropout voltage is a function of drain-to-source on-resistance ( $R_{\text{DS(ON)}}$ ) multiplied by the load current.

$$V_{\text{DROPOUT}} = V_{\text{IN}} - V_{\text{OUT}} = R_{\text{DS(ON)}} \times I_{\text{OUT}}$$

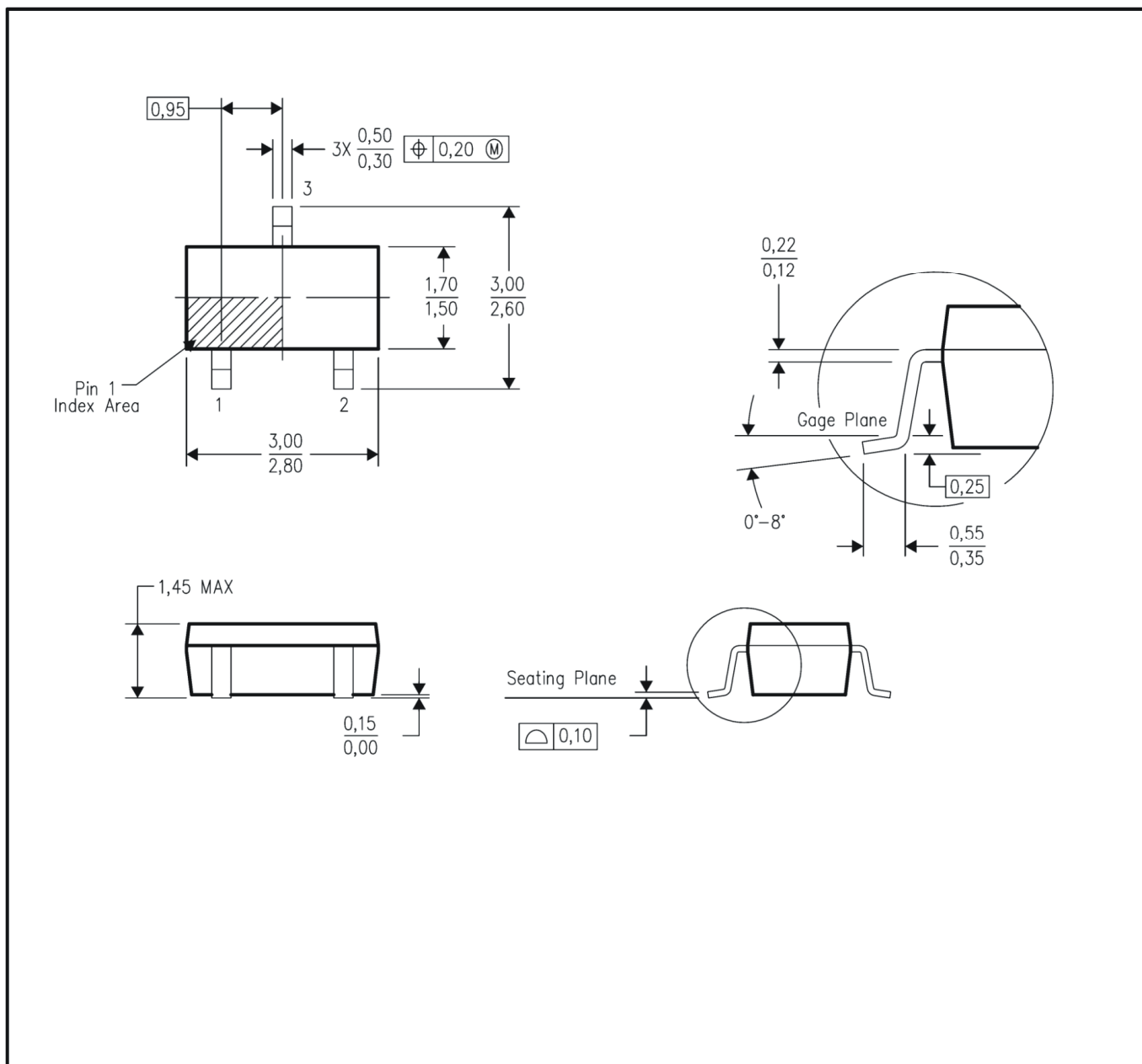

## SOT-23 Dimension

**NOTES:**

- All linear dimensions are in millimeters.
- This drawing is subject to change without notice.
- Body dimensions do not include mold flash or protrusion. Mold flash and protrusion shall not exceed 0.15 per side.



## Soldering Methods for Orister's Products

1. Storage environment: Temperature= $10^{\circ}\text{C}\sim 35^{\circ}\text{C}$  Humidity= $65\%\pm 15\%$

2. Reflow soldering of surface-mount devices

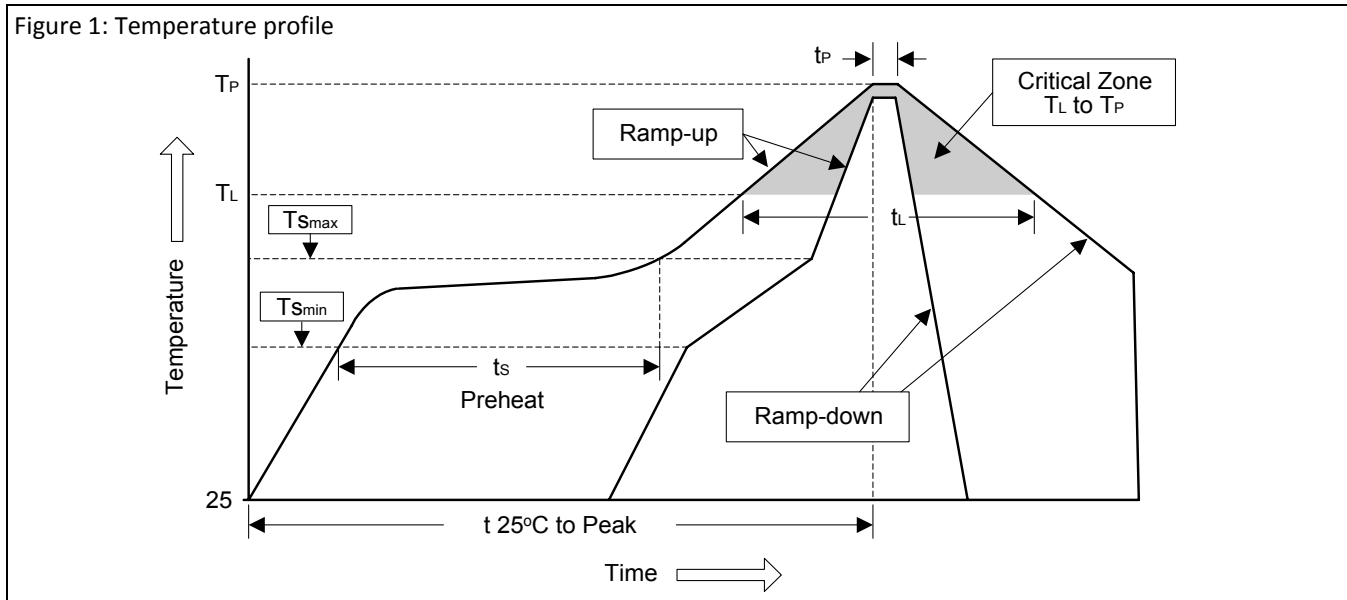

Profile Feature	Sn-Pb Eutectic Assembly	Pb-Free Assembly
Average ramp-up rate ( $T_L$ to $T_P$ )	$<3^{\circ}\text{C}/\text{sec}$	$<3^{\circ}\text{C}/\text{sec}$
Preheat		
- Temperature Min ( $T_{S_{min}}$ )	$100^{\circ}\text{C}$	$150^{\circ}\text{C}$
- Temperature Max ( $T_{S_{max}}$ )	$150^{\circ}\text{C}$	$200^{\circ}\text{C}$
- Time (min to max) ( $t_s$ )	$60\sim 120$ sec	$60\sim 180$ sec
$T_{S_{max}}$ to $T_L$		
- Ramp-up Rate	$<3^{\circ}\text{C}/\text{sec}$	$<3^{\circ}\text{C}/\text{sec}$
Time maintained above:		
- Temperature ( $T_L$ )	$183^{\circ}\text{C}$	$217^{\circ}\text{C}$
- Time ( $t_L$ )	$60\sim 150$ sec	$60\sim 150$ sec
Peak Temperature ( $T_P$ )	$240^{\circ}\text{C} +0/-5^{\circ}\text{C}$	$260^{\circ}\text{C} +0/-5^{\circ}\text{C}$
Time within $5^{\circ}\text{C}$ of actual Peak Temperature ( $t_P$ )	$10\sim 30$ sec	$20\sim 40$ sec
Ramp-down Rate	$<6^{\circ}\text{C}/\text{sec}$	$<6^{\circ}\text{C}/\text{sec}$
Time $25^{\circ}\text{C}$ to Peak Temperature	$<6$ minutes	$<8$ minutes

3. Flow (wave) soldering (solder dipping)

Products	Peak temperature	Dipping time
Pb devices.	$245^{\circ}\text{C} \pm 5^{\circ}\text{C}$	$5\text{sec} \pm 1\text{sec}$
Pb-Free devices.	$260^{\circ}\text{C} +0/-5^{\circ}\text{C}$	$5\text{sec} \pm 1\text{sec}$

***Important Notice:*****© Orister Corporation**

Orister cannot assume responsibility for use of any circuitry other than circuitry entirely embodied in an Orister product. No circuit patent licenses, copyrights, mask work rights, or other intellectual property rights are implied.

Orister reserves the right to make changes to their products or specifications or to discontinue any product or service without notice. Except as provided in Orister's terms and conditions of sale, Orister assumes no liability whatsoever, and Orister disclaims any express or implied warranty relating to the sale and/or use of Orister products including liability or warranties relating to fitness for a particular purpose, merchantability, or infringement of any patent, copyright or other intellectual property right. In order to minimize risks associated with the customer's applications, adequate design and operating safeguards must be provided by the customer to minimize inherent or procedural hazards. Testing and other quality control techniques are utilized to the extent Orister deems necessary to support this warranty. Specific testing of all parameters of each device is not necessarily performed.

Orister and the Orister logo are trademarks of Orister Corporation. All other brand and product names appearing in this document are registered trademarks or trademarks of their respective holders.