

SGM9125

5-Channel, 5th-Order, Standard Definition Video Filter Driver

PRODUCT DESCRIPTION

The SGM9125 is a low voltage, 5-channel video amplifier with integrated reconstruction filters and input clamps. Specially suited for standard definition video signals, this device is ideal for a wide range of television and set-top box applications.

SGM9125 offers 6dB gain rail-to-rail output driver and 5th-order output reconstruction filter on all five channels. It has 8MHz -3dB bandwidth and 35V/ μ s slew rate. SGM9125 provides improved image quality compared with passive LC filters and discrete drivers solution. Operating from single power supply ranging from 3.3V to 5.5V and sinking an ultra-low 44mA quiescent current, the SGM9125 is ideally suited for battery powered applications.

SGM9125 can be DC-coupled or AC-coupled with input video signal, such as the output stage of DAC to eliminate out-of-band noise. The output in SGM9125 can be configured as DC- or AC-coupled output.

The SGM9125 is available in Green TSSOP-14 package. It operates over an ambient temperature range of -40°C to +85°C.

FEATURES

- 5-Channel 5th-Order 8MHz (SD) Filters
- Transparent Input Clamping
- 6dB Output Driver Gain
- Rail-to-Rail Output
- Input Voltage Range Includes Ground
- AC- or DC-Coupled Inputs
- AC- or DC-Coupled Outputs
- Operates from 3.3V to 5.5V Power Supply
- Low Power
 - 44mA Total Supply Current
- Available in Green TSSOP-14 Package
- -40°C to +85°C Operating Temperature Range

APPLICATIONS

Cable and Satellite Set-Top Boxes
Video Amplifiers
Communications Devices
Portable and Handheld Products
Personal Video Recorders
Video on Demand
DVD Players
HDTVs

BLOCK DIAGRAM

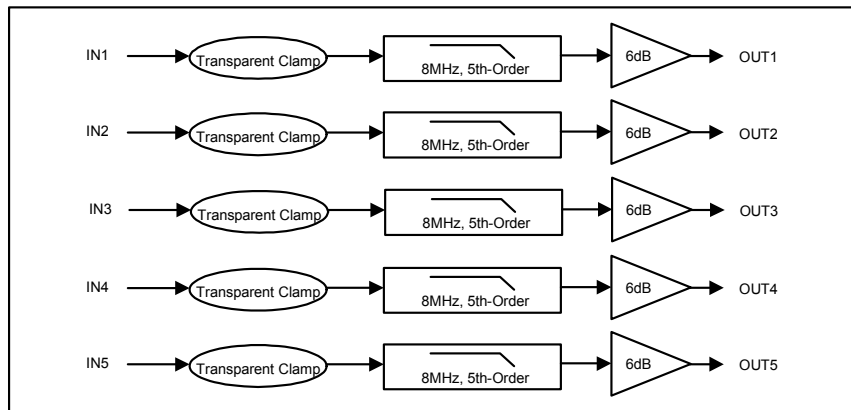

SGM9125

5-Channel, 5th-Order, Standard Definition Video Filter Driver

PACKAGE/ORDERING INFORMATION

ORDER NUMBER	PACKAGE DESCRIPTION	TEMPERATURE RANGE	PACKAGE OPTION	MARKING INFORMATION
SGM9125YTS14G/TR	TSSOP-14	-40°C to +85°C	Tape and Reel, 3000	SGM9125YTS14

PIN CONFIGURATION (TOP VIEW)

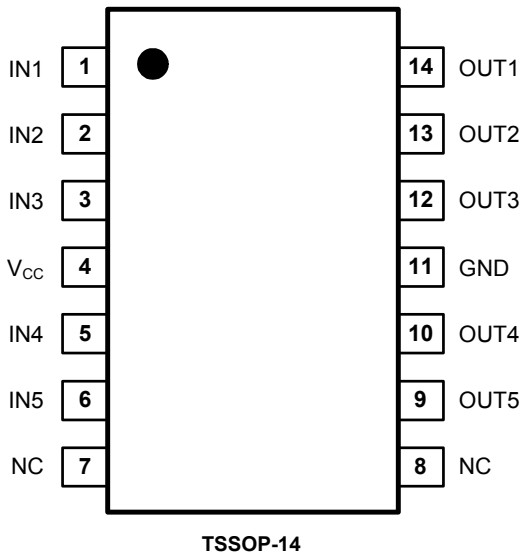

PIN DESCRIPTION

PIN	NAME	FUNCTION
1	IN1	Video Input. Channel 1.
2	IN2	Video Input. Channel 2.
3	IN3	Video Input. Channel 3.
4	V _{CC}	Power Supply.
5	IN4	Video Input. Channel 4.
6	IN5	Video Input. Channel 5.
7	NC	No Connect.
8	NC	No Connect.
9	OUT5	Filtered Output. Channel 5.
10	OUT4	Filtered Output. Channel 4.
11	GND	Ground.
12	OUT3	Filtered Output. Channel 3.
13	OUT2	Filtered Output. Channel 2.
14	OUT1	Filtered Output. Channel 1.

ABSOLUTE MAXIMUM RATINGS

Supply Voltage, GND to V _{CC}	6V
Input Voltage	GND - 0.3V to V _{CC} + 0.3V
Storage Temperature Range	-65°C to +150°C
Junction Temperature	150°C
Operating Temperature Range.....	-40°C to +85°C
Lead Temperature Range (Soldering 10 sec)	260°C
ESD Susceptibility	
HBM.....	8000V
MM.....	400V

NOTE:

Stresses beyond those listed under “Absolute Maximum Ratings” may cause permanent damage to the device. These are stress ratings only, and functional operation of the device at these or any other conditions beyond those indicated in the operational sections of the specifications is not implied. Exposure to absolute maximum rating conditions for extended periods may affect device reliability.

CAUTION

This integrated circuit can be damaged by ESD if you don't pay attention to ESD protection. SGMICRO recommends that all integrated circuits be handled with appropriate precautions. Failure to observe proper handling and installation procedures can cause damage. ESD damage can range from subtle performance degradation to complete device failure. Precision integrated circuits may be more susceptible to damage because very small parametric changes could cause the device not to meet its published specifications.

SGMICRO reserves the right to make any change in circuit design, specification or other related things if necessary without notice at any time. Please contact SGMICRO sales office to get the latest datasheet.

SGM9125

5-Channel, 5th-Order, Standard Definition Video Filter Driver

ELECTRICAL CHARACTERISTICS: $V_{CC} = 5.0V$

(At $R_L = 150\Omega$ connected to GND, $V_{IN} = 1V_{PP}$ and $C_{IN} = 0.1\mu F$, all outputs AC-coupled with $220\mu F$, unless otherwise noted.)

PARAMETER	CONDITIONS	TEMP	MIN	TYP	MAX	UNITS
INPUT CHARACTERISTICS						
Output Level Shift Voltage (V_{OLS})	$V_{IN} = 0V$, No load	+25°C		396	550	mV
		-40°C to +85°C			752	
Input Voltage Clamp (V_{CLAMP})	$I_{IN} = -3.5mA$	+25°C	-180	-110		mV
		-40°C to +85°C	-270			
Clamp Charge Current	$V_{IN} = V_{CLAMP} - 100mV$	+25°C	-6.0	-4.75		mA
		-40°C to +85°C	-6.5			
Voltage Gain (A_V)	$R_L = 150\Omega$	+25°C	5.7	6	6.4	dB
		-40°C to +85°C	5.6		6.5	
OUTPUT CHARACTERISTICS						
Output Voltage High Swing	$V_{IN} = 3V$, $R_L = 150\Omega$ to GND	+25°C	4.60	4.75		V
		-40°C to +85°C	4.53			
POWER SUPPLY						
Operating Voltage Range		+25°C	3.3		5.5	V
Power Supply Rejection Ratio (PSRR)	$V_{CC} = 3.5V$ to $5.0V$	+25°C	44	51		dB
		-40°C to +85°C	37			
Quiescent Current (I_Q)	$V_{IN} = 0.5V$	+25°C		44	55	mA
		-40°C to +85°C			63	
AC PERFORMANCE						
-0.1dB Bandwidth	$R_L = 150\Omega$	+25°C		5.8		MHz
-3dB Bandwidth	$R_L = 150\Omega$	+25°C		7.8		MHz
Filter Response (Normalized Gain)	$f_{IN} = 27MHz$	+25°C		43		dB
Slew Rate	2V Output step, 80% to 20%	+25°C		35		V/ μs
Differential Gain (DG)	PAL DC-coupled	+25°C		0.21		%
	PAL AC-coupled	+25°C		0.23		%
Differential Phase (DP)	PAL DC-coupled	+25°C		1.05		°
	PAL AC-coupled	+25°C		1.13		°
Group Delay Variation (D/DT)	Difference between 400kHz and 6.5MHz	+25°C		30.4		ns
Crosstalk (channel-to-channel)	$f = 1MHz$	+25°C		-65		dB
Fall Time	2V Output step, 80% to 20%	+25°C		34.4		ns
Rise Time	2V Output step, 80% to 20%	+25°C		35.4		ns

TYPICAL PERFORMANCE CHARACTERISTICS

At $V_{CC} = 5V$, $T_A = +25^{\circ}C$, $R_L = 150\Omega$, all outputs AC-coupled with $220\mu F$, unless otherwise noted.

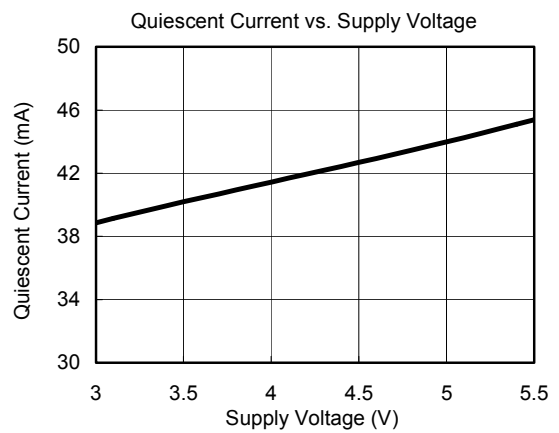
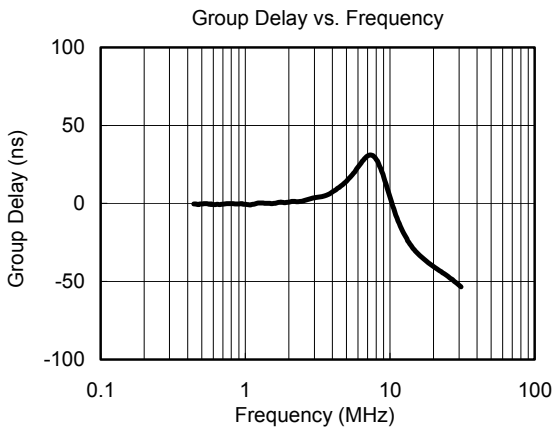
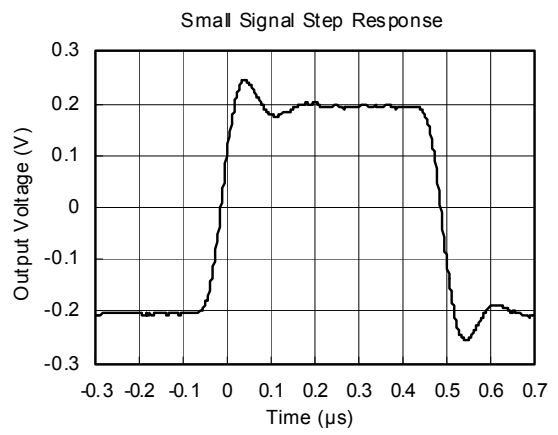
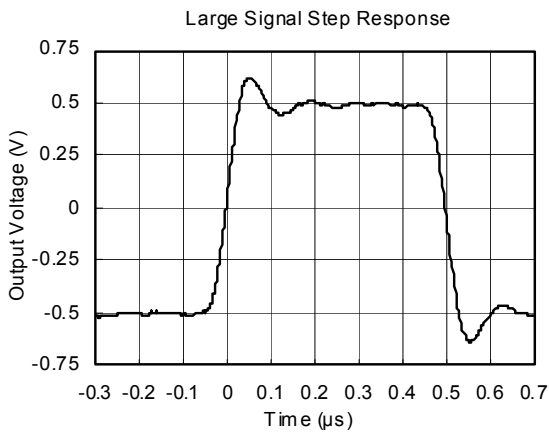
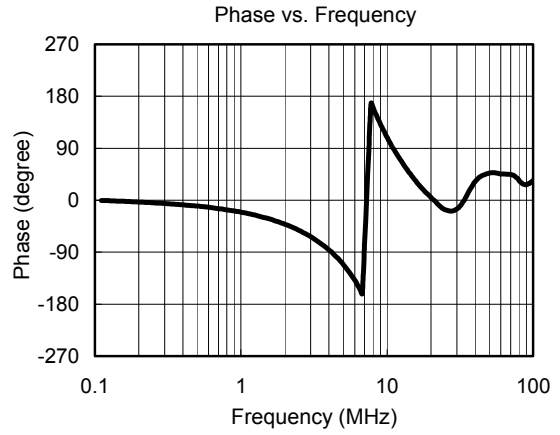
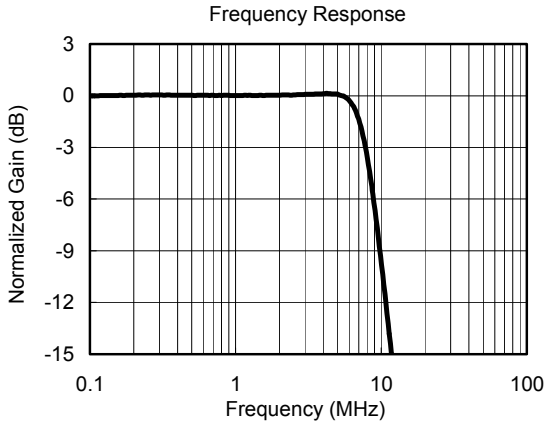

TYPICAL PERFORMANCE CHARACTERISTICS

At $V_{CC} = 5V$, $T_A = +25^\circ C$, $R_L = 150\Omega$, all outputs AC-coupled with $220\mu F$, unless otherwise noted.

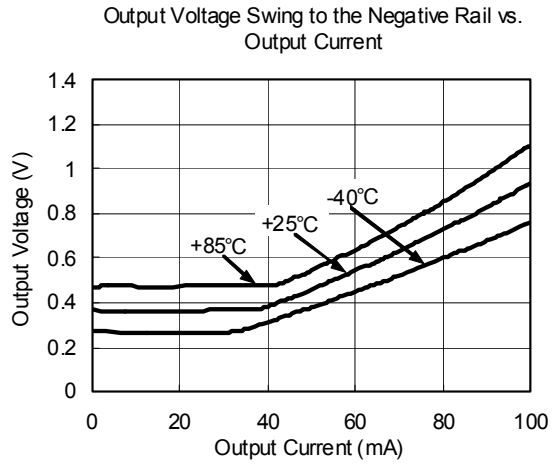
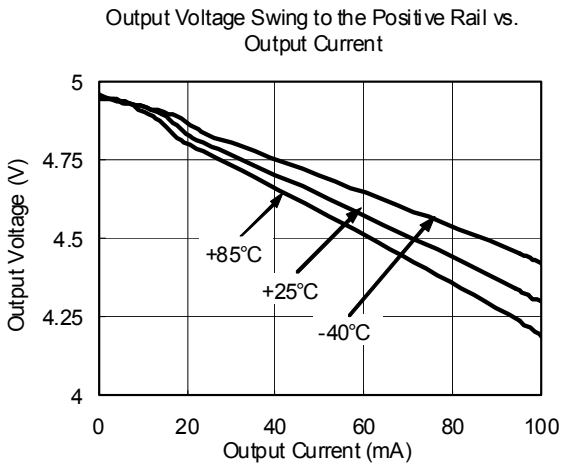
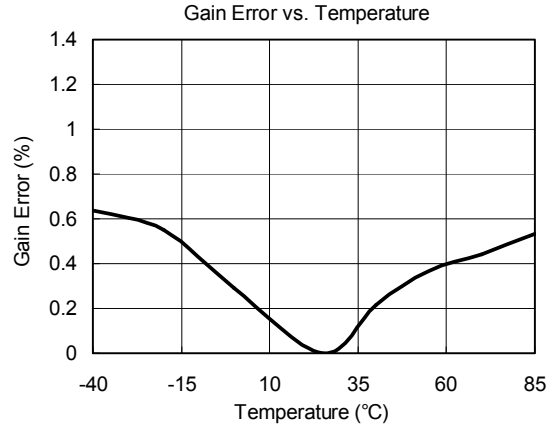
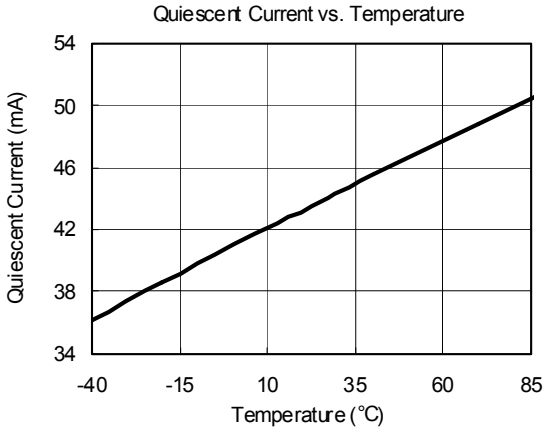

SGM9125

APPLICATION INFORMATION

Functional Description

SGM9125 operates from a single 3.3V to 5.5V supply. In application, SGM9125 is a fully integrated solution for filtering and buffering SDTV signals in front of video decoder or behind video encoder. For example, SGM9125 can replace five passive LC filters and five amplifier drivers in set-top box and DVD player. This solution can help reduce PCB size and production cost, and it also improves video signal performance comparing with traditional design using discrete components. SGM9125 features a DC-coupled input buffer, a 5-pole low-pass filter to eliminate out-of-band noise of video encoder, and a gain of 6dB in the output amplifier to drive 75Ω load. The AC- or DC-coupled input buffer eliminates sync crush, droop, and field tilt. The output of SGM9125 also can be DC-coupled or AC-coupled.

Input Considerations

Besides AC coupling, the SGM9125 inputs also can be DC-coupled. In DC coupling application, no input coupling capacitors are needed because the amplitude of input video signal from DAC includes ground and extends up to 1.4V, and SGM9125 can be directly connected to the output of a single-supply, current-output DAC without any external bias network. In applications where DAC's output level exceeds the range from 0V to 1.4V, or SGM9125 is driven by an unknown external source or a SCART switch which has its own clamping circuit, AC coupling is needed.

Output Considerations

The SGM9125 outputs can be DC-coupled or AC-coupled. When input is 0V, the SGM9125 output voltage is 396mV typically. In DC coupling design, one 75Ω resistor is used to connect SGM9125's output pin with external load directly, and this serial back-termination resistor is used to match the impedance of the transmission line between SGM9125 and external load to cancel the signal reflection. The SGM9125 outputs can sink and source current allowing the device to be AC-coupled with external load. In AC coupling, at least 220μF capacitor will be used in order to eliminate field tilt.

Power-Supply Bypassing and Layout

Correct power supply bypassing is very important for optimizing video performance in design. One 0.1μF and one 10μF capacitors are always used to bypass V_{CC} pin of SGM9125. Place these two capacitors as close to the SGM9125 supply pin as possible. A large ground plane is also needed to ensure optimum performance. The input and output termination resistors should be placed as close to the related pins of SGM9125 as possible to avoid performance degradation. The PCB traces at the output side should have 75Ω characteristic impedance in order to match the 75Ω characteristic impedance of the cable connecting external load. In design, keep the board trace at the inputs and outputs of the SGM9125 as short as possible to minimize the parasitic stray capacitance and noise pickup.

TYPICAL APPLICATION DIAGRAM

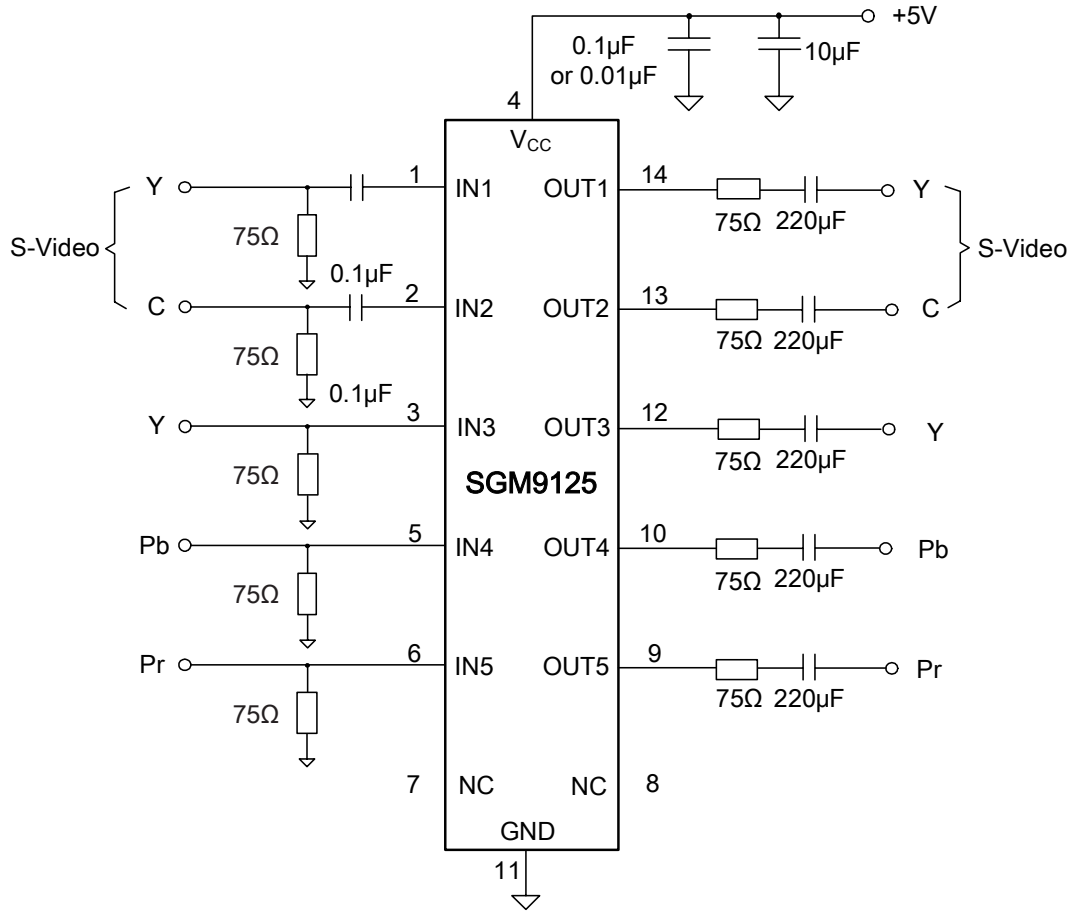
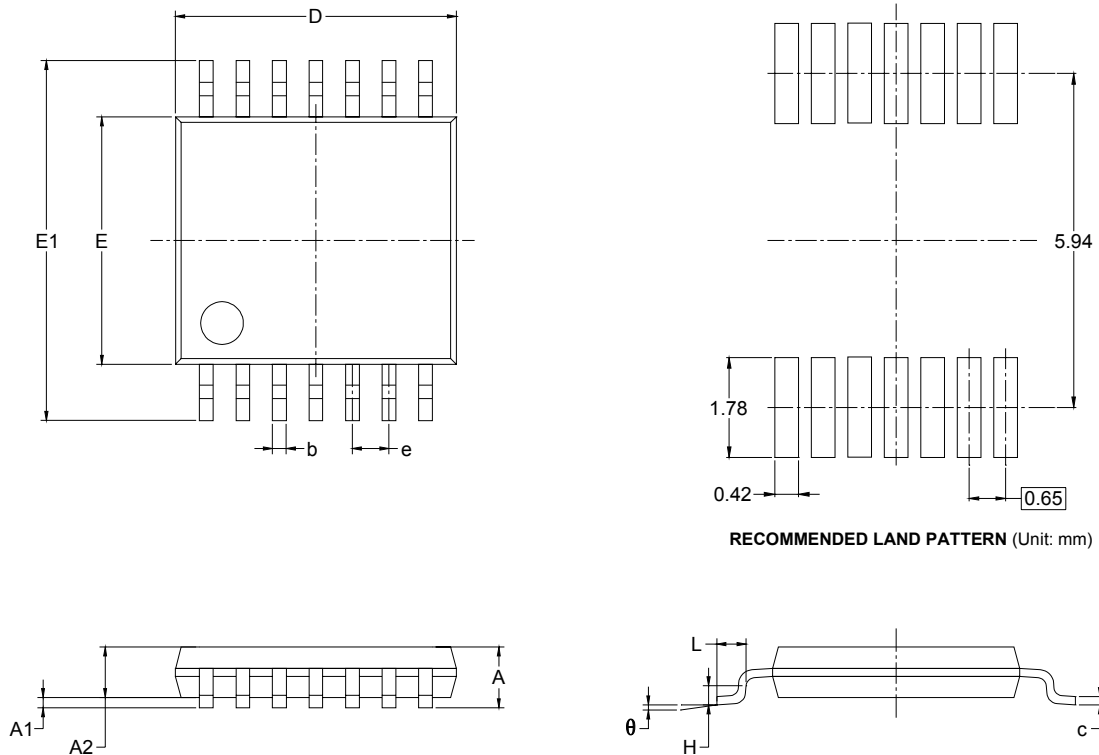

Figure 1. AC Coupling Application Schematic

PACKAGE OUTLINE DIMENSIONS

TSSOP-14



Symbol	Dimensions In Millimeters		Dimensions In Inches	
	MIN	MAX	MIN	MAX
A		1.100		0.043
A1	0.050	0.150	0.002	0.006
A2	0.800	1.000	0.031	0.039
b	0.190	0.300	0.007	0.012
c	0.090	0.200	0.004	0.008
D	4.900	5.100	0.193	0.201
E	4.300	4.500	0.169	0.177
E1	6.250	6.550	0.246	0.258
e	0.650 BSC		0.026 BSC	
L	0.500	0.700	0.02	0.028
H	0.25 TYP		0.01 TYP	
θ	1°	7°	1°	7°