

# SGM8774-1

## High Voltage, High Precision, Single Differential Comparator

---

### GENERAL DESCRIPTION

The SGM8774-1 is a single, high precision voltage comparator optimized for high voltage operation. The device can operate from 2.8V to 36V single supply or from  $\pm 1.4V$  to  $\pm 18V$  dual power supplies. It consumes low supply current without being affected by the supply voltage. Input common mode voltage is 1.5V lower than  $+V_S$ . The SGM8774-1 has an open-drain output structure that needs external pull-up resistor.

The SGM8774-1 features low input offset voltage of 2.8mV (MAX). It is suitable for applications requiring precision.

The SGM8774-1 is available in a Green SOT-23-5 package. It is rated over the  $-40^{\circ}C$  to  $+125^{\circ}C$  operating temperature range.

### FEATURES

- **Wide Supply Ranges**  
Single Supply: 2.8V to 36V  
Dual Supplies:  $\pm 1.4V$  to  $\pm 18V$
- **Low Supply Current: 240 $\mu$ A (TYP)**
- **Low Input Offset Voltage: 2.8mV (MAX)**
- **Low Input Bias Current:  $\pm 20pA$  (TYP)**
- **Open-Drain Output Structure**
- **Supports CMOS or TTL Logic**
- **$-40^{\circ}C$  to  $+125^{\circ}C$  Operating Temperature Range**
- **Available in a Green SOT-23-5 Package**

### APPLICATIONS

Power System Monitor  
Medical Equipment  
Industrial Application  
Battery Management System

**PACKAGE/ORDERING INFORMATION**

MODEL	PACKAGE DESCRIPTION	SPECIFIED TEMPERATURE RANGE	ORDERING NUMBER	PACKAGE MARKING	PACKING OPTION
SGM8774A-1	SOT-23-5	-40°C to +125°C	SGM8774A-1XN5G/TR	OP6XX	Tape and Reel, 3000
SGM8774B-1	SOT-23-5	-40°C to +125°C	SGM8774B-1XN5G/TR	OP7XX	Tape and Reel, 3000
SGM8774C-1	SOT-23-5	-40°C to +125°C	SGM8774C-1XN5G/TR	OP8XX	Tape and Reel, 3000
SGM8774D-1	SOT-23-5	-40°C to +125°C	SGM8774D-1XN5G/TR	RCBXX	Tape and Reel, 3000

**MARKING INFORMATION**

NOTE: XX = Date Code.

**YYY X X**

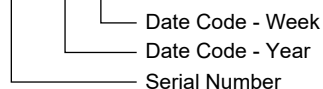

Green (RoHS & HSF): SG Micro Corp defines "Green" to mean Pb-Free (RoHS compatible) and free of halogen substances. If you have additional comments or questions, please contact your SGMICRO representative directly.

**ABSOLUTE MAXIMUM RATINGS**

- Supply Voltage, +V<sub>S</sub> to -V<sub>S</sub>..... 40V
- Differential Input Voltage, |V<sub>ID</sub>| ..... 40V
- Input/Output Voltage Range..... (-V<sub>S</sub>) - 0.3V to (+V<sub>S</sub>) + 0.3V
- Junction Temperature .....+150°C
- Storage Temperature Range.....-65°C to +150°C
- Lead Temperature (Soldering, 10s) .....+260°C
- ESD Susceptibility
- HBM..... 3000V
- CDM ..... 1000V

**RECOMMENDED OPERATING CONDITIONS**

- Operating Temperature Range .....-40°C to +125°C
- Power Supply Range .....2.8V to 36V

**OVERSTRESS CAUTION**

Stresses beyond those listed in Absolute Maximum Ratings may cause permanent damage to the device. Exposure to absolute maximum rating conditions for extended periods may affect reliability. Functional operation of the device at any

conditions beyond those indicated in the Recommended Operating Conditions section is not implied.

**ESD SENSITIVITY CAUTION**

This integrated circuit can be damaged if ESD protections are not considered carefully. SGMICRO recommends that all integrated circuits be handled with appropriate precautions. Failure to observe proper handling and installation procedures can cause damage. ESD damage can range from subtle performance degradation to complete device failure. Precision integrated circuits may be more susceptible to damage because even small parametric changes could cause the device not to meet the published specifications.

**DISCLAIMER**

SG Micro Corp reserves the right to make any change in circuit design, or specifications without prior notice.

PIN CONFIGURATIONS

SGM8774A-1 (TOP VIEW)

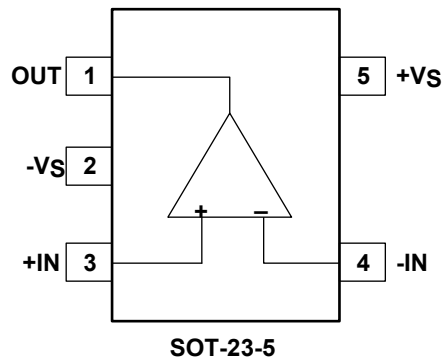

SGM8774B-1 (TOP VIEW)

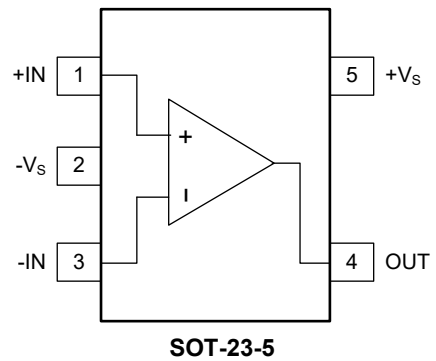

SGM8774C-1 (TOP VIEW)

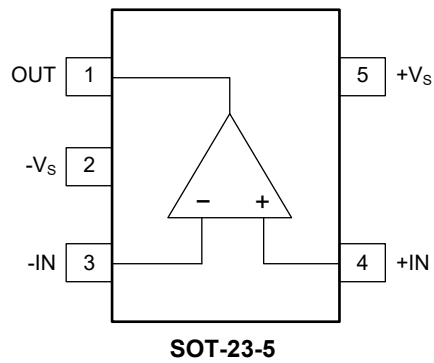

SGM8774D-1 (TOP VIEW)

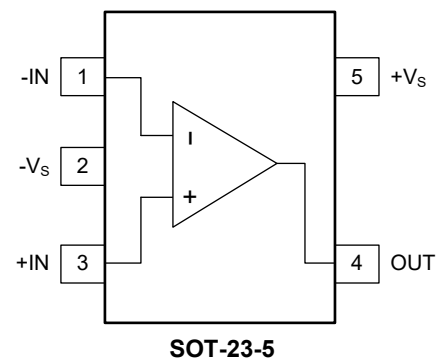

**ELECTRICAL CHARACTERISTICS**(V<sub>S</sub> = ±1.4V to ±18V, Full = -40°C to +125°C, typical values are at T<sub>A</sub> = +25°C, unless otherwise noted.)

PARAMETER	SYMBOL	CONDITIONS	TEMP	MIN	TYP	MAX	UNITS
Input Offset Voltage	V <sub>OS</sub>	V <sub>CM</sub> = 0V	+25°C		0.8	2.8	mV
			Full			3	
Input Bias Current	I <sub>B</sub>	V <sub>CM</sub> = 0V	+25°C		±20	±200	pA
Input Bias Current	I <sub>OS</sub>	V <sub>CM</sub> = 0V	+25°C		±20	±200	pA
Input Common Mode Voltage Range <sup>(1)</sup>	V <sub>CM</sub>		Full	-V <sub>S</sub>		(+V <sub>S</sub> ) - 1.5	V
Common Mode Rejection Ratio	CMRR	V <sub>S</sub> = ±18V, V <sub>CM</sub> = (-V <sub>S</sub> ) to (+V <sub>S</sub> ) - 1.5V	+25°C	84	100		dB
			Full	78			
Power Supply Rejection Ratio	PSRR		+25°C	102	120		dB
			Full	99			
Large-Signal Differential Voltage Amplification	A <sub>VD</sub>	V <sub>S</sub> = 36V, V <sub>OUT</sub> = 0.1V to 28.8V, R <sub>L</sub> = 120kΩ to V <sub>S</sub>	+25°C	100	110		dB
			Full	97			
Low-Level Output Voltage	V <sub>OL</sub>	I <sub>OL</sub> = -8mA, V <sub>ID</sub> = -0.2V	+25°C		230	300	mV
			Full			400	
Output Short-Circuit Current	I <sub>SIK</sub>	V <sub>OL</sub> = (-V <sub>S</sub> ) + 1.5V, V <sub>ID</sub> = -0.2V	+25°C	29	36		mA
High-Level Output Current	I <sub>OH</sub>	V <sub>OH</sub> - (-V <sub>S</sub> ) = 2.8V, V <sub>ID</sub> = 0.2V	+25°C		0.7	1	μA
			Full			3	
		V <sub>OH</sub> - (-V <sub>S</sub> ) = 36V, V <sub>ID</sub> = 0.2V	+25°C		4	12	
			Full			22	
Supply Current	I <sub>S</sub>	I <sub>OUT</sub> = 0A	+25°C		240	290	μA
			Full			320	

**SWITCHING CHARACTERISTICS**(At T<sub>A</sub> = +25°C, V<sub>S</sub> = ±2.5V, V<sub>CM</sub> = 0V, C<sub>L</sub> = 15pF <sup>(2)</sup>, unless otherwise specified.)

PARAMETER	SYMBOL	CONDITIONS	TEMP	MIN	TYP	MAX	UNITS
Propagation Delay (High to Low)	t <sub>PHL</sub>	Overdrive = 10mV	+25°C		90		ns
		Overdrive = 100mV	+25°C		50		
Fall Time	t <sub>FALL</sub>	Overdrive = 10mV	+25°C		20		ns
		Overdrive = 100mV	+25°C		20		

## NOTES:

- Any input voltage should not be lower than (-V<sub>S</sub>) - 0.3V. The maximum input common mode voltage is (+V<sub>S</sub>) - 1.5V, but it will not be damaged when the upper limit of the input voltage reaches 36V.
- C<sub>L</sub>: Load capacitance (jig and probe included).

**TYPICAL PERFORMANCE CHARACTERISTICS**

At  $T_A = +25^\circ\text{C}$ ,  $V_S = \pm 18\text{V}$  and  $C_L = 15\text{pF}$ , unless otherwise noted.

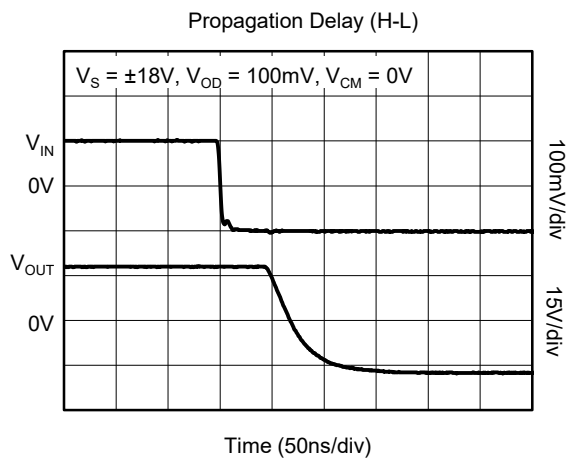
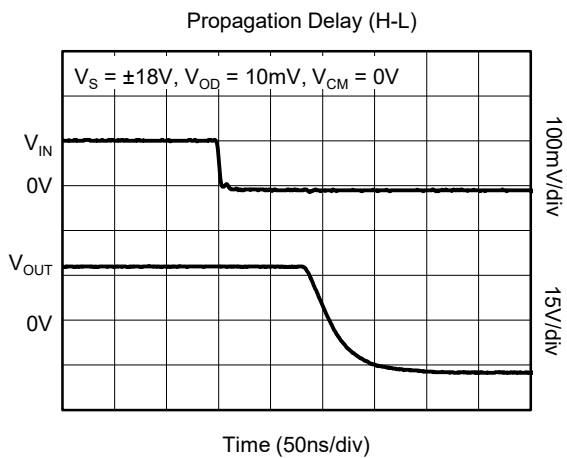
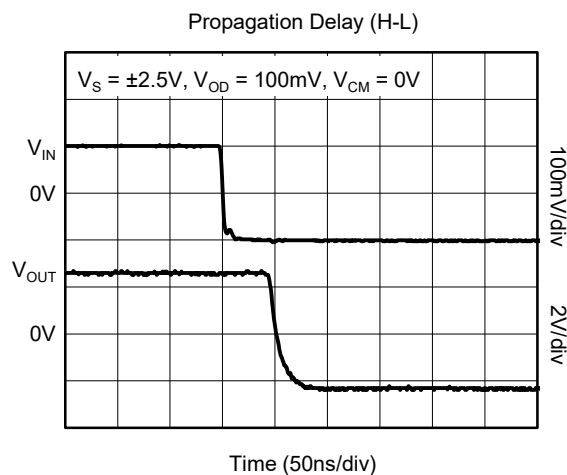
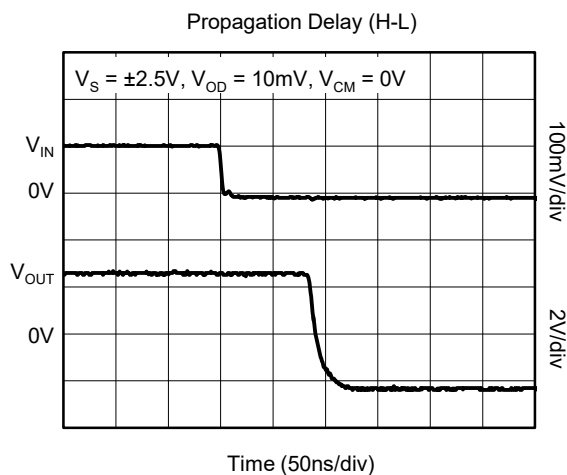
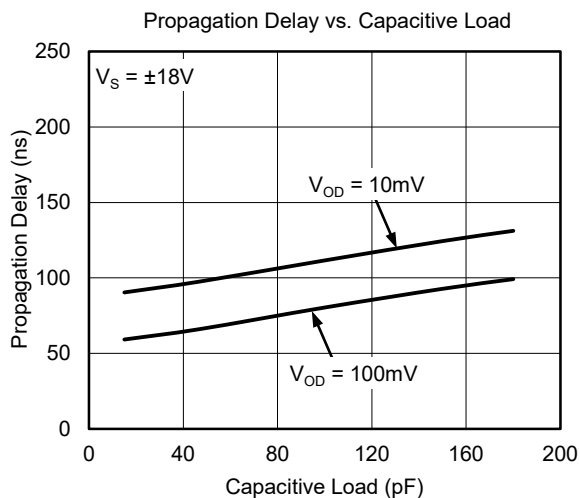
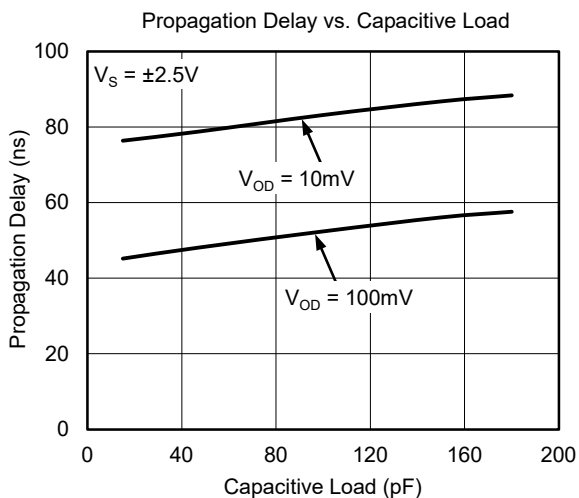

**TYPICAL PERFORMANCE CHARACTERISTICS (continued)**

At  $T_A = +25^\circ\text{C}$ ,  $V_S = \pm 18\text{V}$  and  $C_L = 15\text{pF}$ , unless otherwise noted.

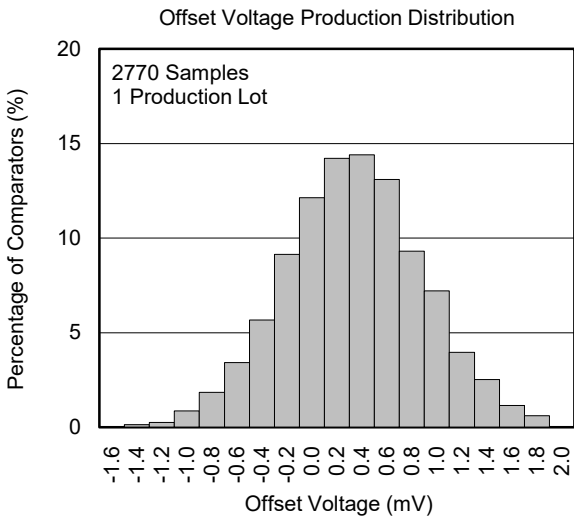
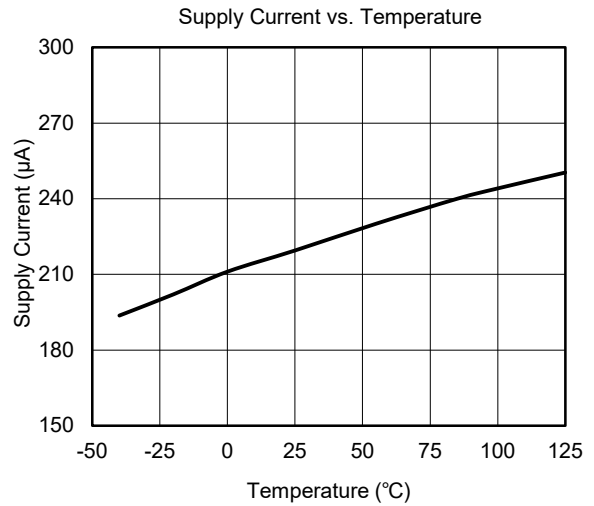
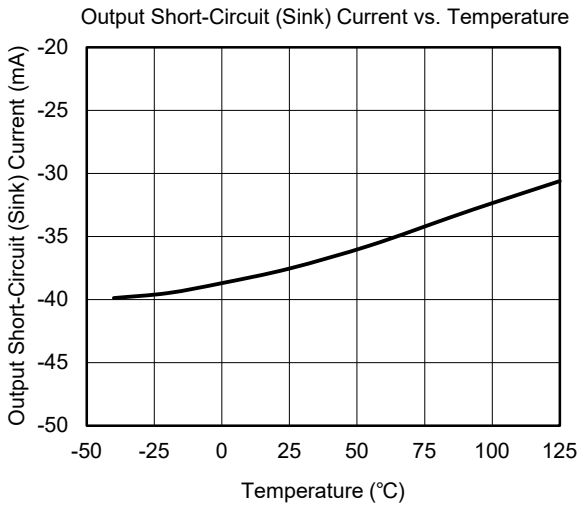
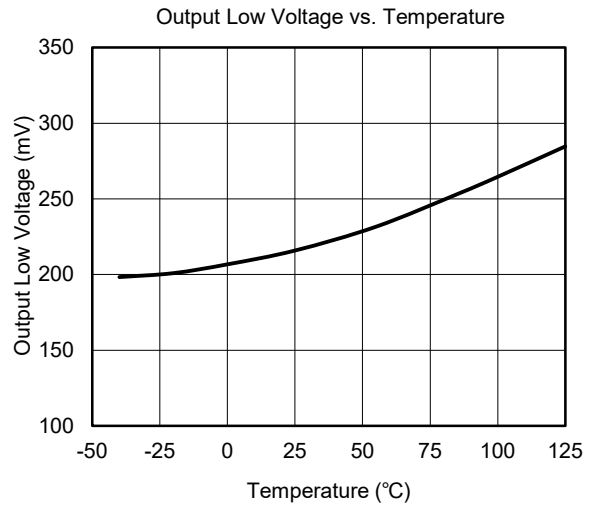
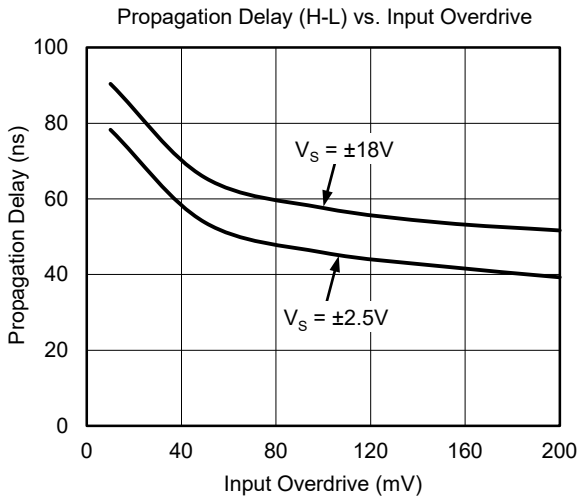

## DETAILED DESCRIPTION

The SGM8774-1 is a single, high precision, low power comparator. The wide input voltage range and power supply range make the device a good choice for industrial equipment. Open-drain structure needs external pull-up resistor. The SGM8774-1 can be compatible with CMOS and TTL logics.

### Output Structure

In Figure 1, the SGM8774-1 has an open-drain output stage. When output is changed from logic high to low, the changed sink current pulls output pin to logic low. Beginning this transition, larger sink current is used to create a high slew rate transit from high to low. Once the output voltage reaches  $V_{OL}$ , it will reduce the sink current to a just right value to maintain the  $V_{OL}$  static condition. This current-driven open-drain output stage will significantly reduce the power consumption in application system.

If low slew rate transition is needed in system design, adjusting the load capacitance will change the slew rate. The heavier capacitive load will slow down the output voltage transition. This feature will be used to reduce the interference generated by fast edge of transition between 1 and 0 in noise-sensitive system.

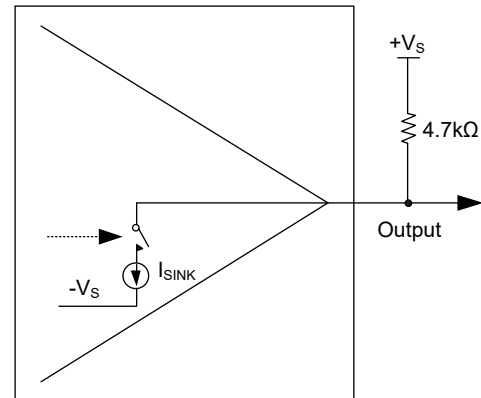

Figure 1. Open-Drain Output Structure

## APPLICATION INFORMATION

### Layout and Bypassing

Good power supply decoupling, layout and grounding are very important for SGM8774-1 to realize the full high-speed capabilities in system, following skills will be used:

- ♦ A 0.1 $\mu$ F to 4.7 $\mu$ F range ceramic capacitor is used to provide good power supply decoupling. This ceramic capacitor must be placed as close to  $+V_S$  pin as possible.

- ♦ For grounding, unbroken and low-inductance ground plane is a good choice.
- ♦ For Layout, use short PCB trace to avoid unwanted parasitic feedback around the comparator. SGM8774-1 must be soldered directly to the PCB and the socket is not recommended.

# PACKAGE INFORMATION

## PACKAGE OUTLINE DIMENSIONS

### SOT-23-5

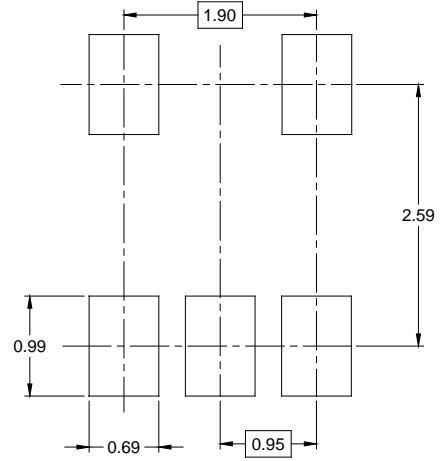
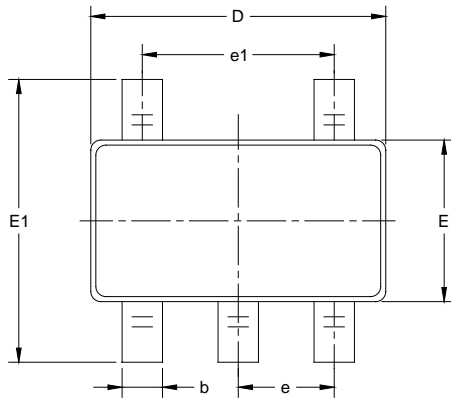

RECOMMENDED LAND PATTERN (Unit: mm)

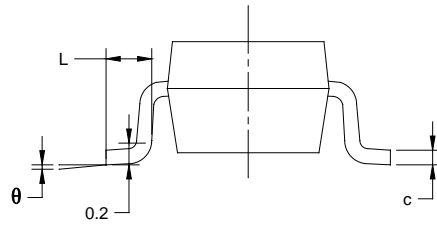
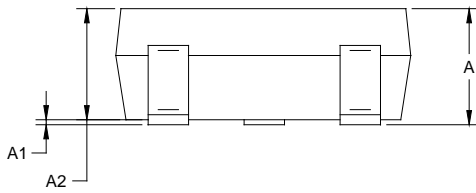

Symbol	Dimensions In Millimeters		Dimensions In Inches	
	MIN	MAX	MIN	MAX
A	1.050	1.250	0.041	0.049
A1	0.000	0.100	0.000	0.004
A2	1.050	1.150	0.041	0.045
b	0.300	0.500	0.012	0.020
c	0.100	0.200	0.004	0.008
D	2.820	3.020	0.111	0.119
E	1.500	1.700	0.059	0.067
E1	2.650	2.950	0.104	0.116
e	0.950 BSC		0.037 BSC	
e1	1.900 BSC		0.075 BSC	
L	0.300	0.600	0.012	0.024
$\theta$	0°	8°	0°	8°

**NOTES:**

1. Body dimensions do not include mode flash or protrusion.
2. This drawing is subject to change without notice.



# PACKAGE INFORMATION

## TAPE AND REEL INFORMATION

### REEL DIMENSIONS



### TAPE DIMENSIONS



NOTE: The picture is only for reference. Please make the object as the standard.

### KEY PARAMETER LIST OF TAPE AND REEL

Package Type	Reel Diameter	Reel Width W1 (mm)	A0 (mm)	B0 (mm)	K0 (mm)	P0 (mm)	P1 (mm)	P2 (mm)	W (mm)	Pin1 Quadrant
SOT-23-5	7"	9.5	3.20	3.20	1.40	4.0	4.0	2.0	8.0	Q3

DD0001

# PACKAGE INFORMATION

## CARTON BOX DIMENSIONS



NOTE: The picture is only for reference. Please make the object as the standard.

## KEY PARAMETER LIST OF CARTON BOX

Reel Type	Length (mm)	Width (mm)	Height (mm)	Pizza/Carton
7" (Option)	368	227	224	8
7"	442	410	224	18

DD0002