

SGM8584

Single-Supply, Quad Rail-to-Rail I/O Precision Operational Amplifier

GENERAL DESCRIPTION

The SGM8584 is a quad rail-to-rail input and output precision operational amplifier which has low input offset voltage and bias current. It is guaranteed to operate from 2.5V to 5.5V single supply.

The rail-to-rail input and output swings provided by the SGM8584 make both high-side and low-side sensing easy. The combination of characteristics makes the SGM8584 a good choice for temperature, position and pressure sensors, medical equipment and strain gauge amplifiers, or any other 2.5V to 5.5V applications requiring precision and long term stability.

The SGM8584 is specified for the extended industrial/automotive (-40°C to +125°C) temperature range. The SGM8584 is available in Green SOIC-14 and TSSOP-14 packages.

APPLICATIONS

Temperature Measurements
Pressure Sensors
Precision Current Sensings
Electronic Scales
Strain Gage Amplifiers
Medical Instrumentation
Thermocouple Amplifiers
Handheld Test Equipment

FEATURES

- **Low Offset Voltage: 100 μ V (MAX)**
- **Rail-to-Rail Input and Output Swings**
- **2.5V to 5.5V Single-Supply Operation**
- **Voltage Gain: 135dB (TYP) at 5V**
- **PSRR: 115dB (TYP)**
- **CMRR: 92dB (TYP)**
- **Low Input Bias Current: 60pA**
- **Low Supply Current: 430 μ A/Amplifier**
- **Overload Recovery Time: 30 μ s (at $V_s = 5V$)**
- **No External Capacitors Required**
- **-40°C to +125°C Operating Temperature Range**
- **Available in Green SOIC-14 and TSSOP-14 Packages**

PIN CONFIGURATIONS

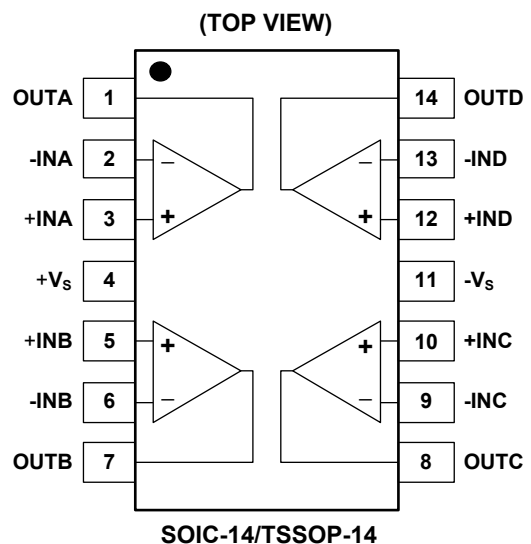

PACKAGE/ORDERING INFORMATION

MODEL	PACKAGE DESCRIPTION	SPECIFIED TEMPERATURE RANGE	ORDERING NUMBER	PACKAGE MARKING	PACKING OPTION
SGM8584	SOIC-14	-40°C to +125°C	SGM8584XS14G/TR	SGM8584XS14 XXXXX	Tape and Reel, 2500
	TSSOP-14	-40°C to +125°C	SGM8584XTS14G/TR	SGM8584 XTS14 XXXXX	Tape and Reel, 3000

MARKING INFORMATION

NOTE: XXXXX = Date Code and Vendor Code.

XXXXX

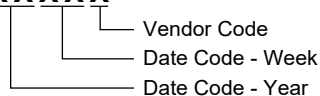

Green (RoHS & HSF): SG Micro Corp defines "Green" to mean Pb-Free (RoHS compatible) and free of halogen substances. If you have additional comments or questions, please contact your SGMICRO representative directly.

ABSOLUTE MAXIMUM RATINGS

- Supply Voltage 6V
- Input Voltage Range -V_S to (+V_S) + 0.1V
- Differential Input Voltage Range -5V to 5V
- Junction Temperature +150°C
- Storage Temperature Range -65°C to +150°C
- Lead Temperature (Soldering, 10s) +260°C
- ESD Susceptibility
- HBM (TSSOP-14) 8000V
- HBM (SOIC-14) 7000V
- MM 400V

RECOMMENDED OPERATING CONDITIONS

- Operating Temperature Range -40°C to +125°C

OVERSTRESS CAUTION

Stresses beyond those listed in Absolute Maximum Ratings may cause permanent damage to the device. Exposure to absolute maximum rating conditions for extended periods may affect reliability. Functional operation of the device at any conditions beyond those indicated in the Recommended Operating Conditions section is not implied.

ESD SENSITIVITY CAUTION

This integrated circuit can be damaged by ESD if you don't pay attention to ESD protection. SGMICRO recommends that all integrated circuits be handled with appropriate precautions. Failure to observe proper handling and installation procedures can cause damage. ESD damage can range from subtle performance degradation to complete device failure. Precision integrated circuits may be more susceptible to damage because very small parametric changes could cause the device not to meet its published specifications.

DISCLAIMER

SG Micro Corp reserves the right to make any change in circuit design, or specifications without prior notice.

ELECTRICAL CHARACTERISTICS(V_S = 5V, V_{CM} = 2.5V, V_{OUT} = 2.5V, Full = -40°C to +125°C, typical values are at T_A = +25°C, unless otherwise noted.)

PARAMETER	CONDITIONS	TEMP	MIN	TYP	MAX	UNITS
Input Characteristics						
Input Offset Voltage (V _{OS})		+25°C		25	100	μV
		Full			110	
Input Offset Voltage Drift (ΔV _{OS} /ΔT)		Full		150		nV/°C
Input Bias Current (I _B)		+25°C		60		pA
Input Offset Current (I _{OS})		+25°C		50		pA
Input Voltage Range		+25°C	0		5	V
Common Mode Rejection Ratio ⁽¹⁾ (CMRR)	V _{CM} = 0V to 5V	+25°C	88	92		dB
		Full	77			
Large-Signal Voltage Gain (A _{VO})	R _L = 10kΩ, V _{OUT} = 0.3V to 4.7V	+25°C	120	135		dB
		Full	104			
Output Characteristics						
Output Voltage High (V _{OH})	R _L = 100kΩ to -V _S	+25°C	4.9	4.998		V
		Full	4.894			
	R _L = 10kΩ to -V _S	+25°C	4.9	4.994		
		Full	4.888			
Output Voltage Low (V _{OL})	R _L = 100kΩ to +V _S	+25°C		3.5	6	mV
		Full			8	
	R _L = 10kΩ to +V _S	+25°C		7	10	
		Full			23	
Short-Circuit Limit (I _{SC})	V _{OUT} = 2.5V, R _L = 10Ω to GND	+25°C	30	40		mA
		Full	22			
Power Supply						
Power Supply Rejection Ratio ⁽¹⁾ (PSRR)	V _S = 2.5V to 5.5V	+25°C	90	115		dB
		Full	80			
Quiescent Current/Amplifier (I _Q)	V _{OUT} = V _S /2	+25°C		430	555	μA
		Full			710	
Dynamic Performance						
Gain-Bandwidth Product (GBP)	A _V = +100	+25°C		1.5		MHz
Slew Rate (SR)	A _V = +1, R _L = 10kΩ, 2V output step	+25°C		0.9		V/μs
Overload Recovery Time	A _V = -100, R _L = 10kΩ, V _{IN} = 200mV (RET to GND)	+25°C		0.03		ms
Noise						
Input Voltage Noise	0.1Hz to 10Hz	+25°C		1.4		μV _{P-P}
Input Voltage Noise Density (e _n)	f = 1kHz	+25°C		78		nV/√Hz

NOTE: 1. PSRR and CMRR are affected by the matching between external gain-setting resistor ratios.

ELECTRICAL CHARACTERISTICS (continued)(V_S = 2.5V, V_{CM} = 1.25V, V_{OUT} = 1.25V, Full = -40°C to +125°C, typical values are at T_A = +25°C, unless otherwise noted.)

PARAMETER	CONDITIONS	TEMP	MIN	TYP	MAX	UNITS
Input Characteristics						
Input Offset Voltage (V _{OS})		+25°C		25	100	μV
		Full			120	
Input Offset Voltage Drift (ΔV _{OS} /ΔT)		Full		150		nV/°C
Input Bias Current (I _B)		+25°C		30		pA
Input Offset Current (I _{OS})		+25°C		20		pA
Input Voltage Range		+25°C	0		2.5	V
Common Mode Rejection Ratio ⁽¹⁾ (CMRR)	V _{CM} = 0V to 2.5V	+25°C	79	85		dB
		Full	70			
Large-Signal Voltage Gain (A _{VO})	R _L = 10kΩ, V _{OUT} = 0.3V to 2.4V	+25°C	120	130		dB
		Full	104			
Output Characteristics						
Output Voltage High (V _{OH})	R _L = 100kΩ to -V _S	+25°C	2.4	2.499		V
		Full	2.38			
	R _L = 10kΩ to -V _S	+25°C	2.4	2.497		
		Full	2.389			
Output Voltage Low (V _{OL})	R _L = 100kΩ to +V _S	+25°C		4	6	mV
		Full			7	
	R _L = 10kΩ to +V _S	+25°C		6	8	
		Full			12	
Short-Circuit Limit (I _{SC})	V _{OUT} = 1.25V, R _L = 10Ω to GND	+25°C	20	28		mA
		Full	13			
Power Supply						
Power Supply Rejection Ratio ⁽¹⁾ (PSRR)	V _S = 2.5V to 5.5V	+25°C	90	115		dB
		Full	80			
Quiescent Current/Amplifier (I _Q)	V _{OUT} = V _S /2	+25°C		430	550	μA
		Full			710	
Dynamic Performance						
Gain-Bandwidth Product (GBP)	A _V = +100	+25°C		1.5		MHz
Slew Rate (SR)	A _V = +1, R _L = 10kΩ, 2V output step	+25°C		1.0		V/μs
Overload Recovery Time	A _V = -100, R _L = 10kΩ, V _{IN} = 200mV (RET to GND)	+25°C		0.02		ms
Noise						
Input Voltage Noise	0.1Hz to 10Hz	+25°C		1.7		μV _{P-P}
Input Voltage Noise Density (e _n)	f = 1kHz	+25°C		108		nV/√Hz

NOTE: 1. PSRR and CMRR are affected by the matching between external gain-setting resistor ratios.

TYPICAL PERFORMANCE CHARACTERISTICS

Large-Signal Step Response

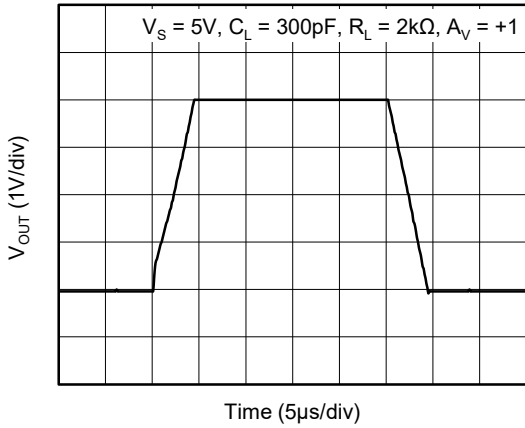

Large-Signal Step Response

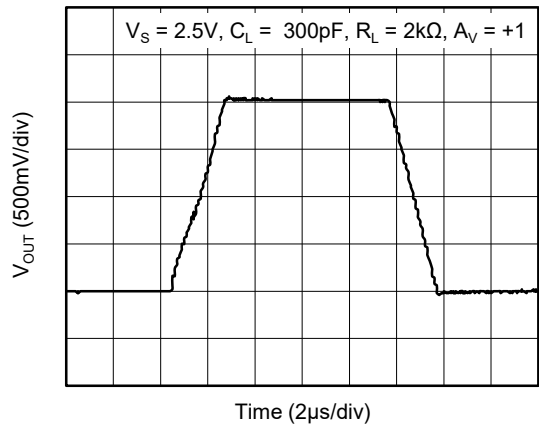

Small-Signal Step Response

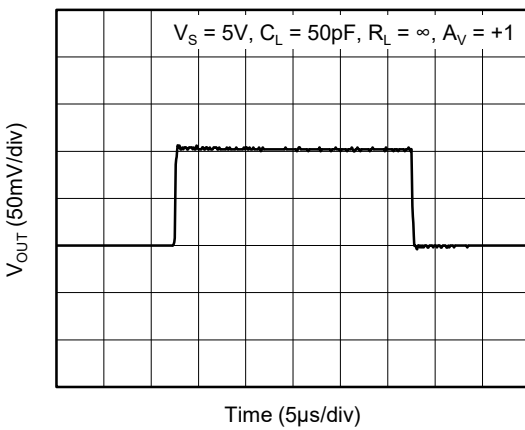

Small-Signal Step Response

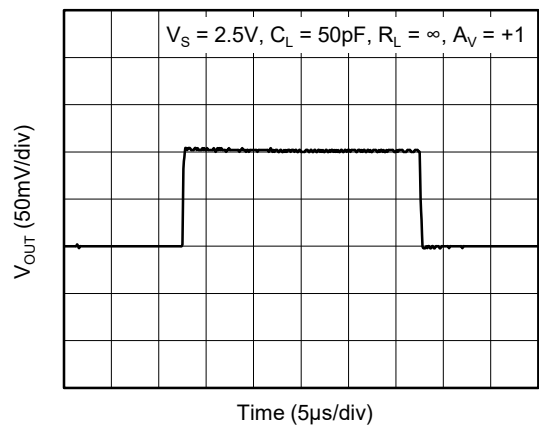

Negative Over-Voltage Recovery

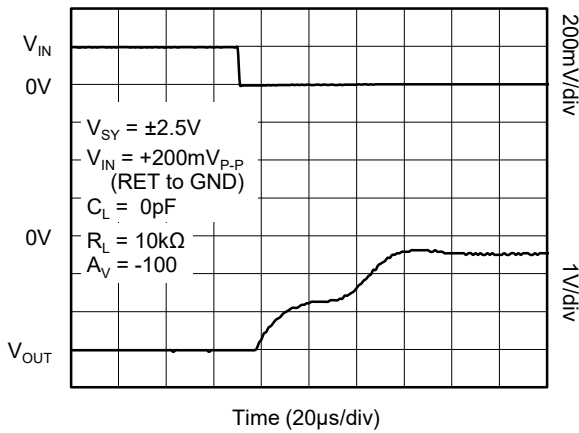

Positive Over-Voltage Recovery

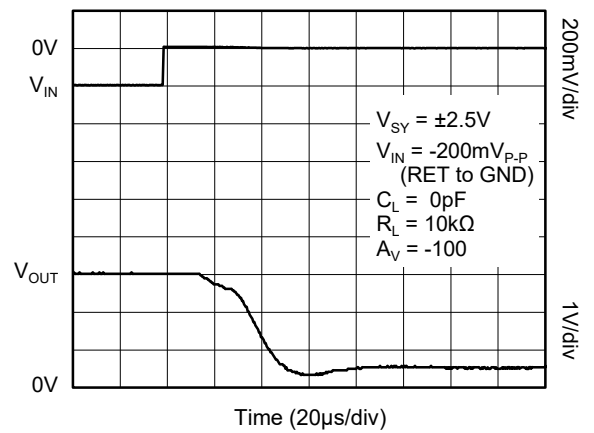

TYPICAL PERFORMANCE CHARACTERISTICS (continued)

0.1Hz to 10Hz Input Voltage Noise

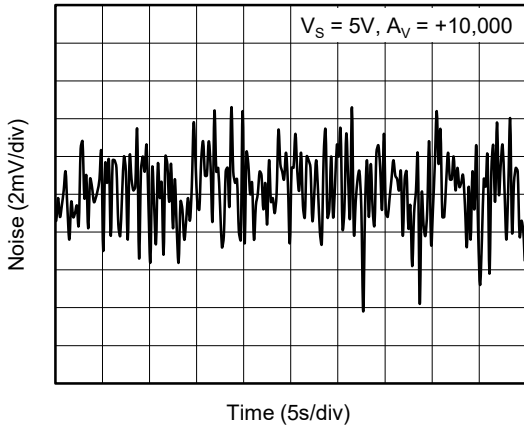

0.1Hz to 10Hz Input Voltage Noise

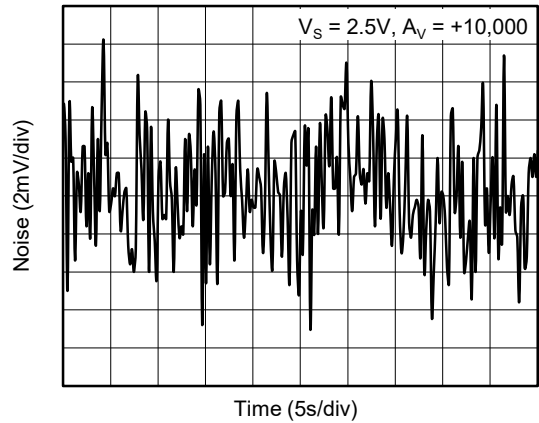

Input Voltage Noise Density vs. Frequency

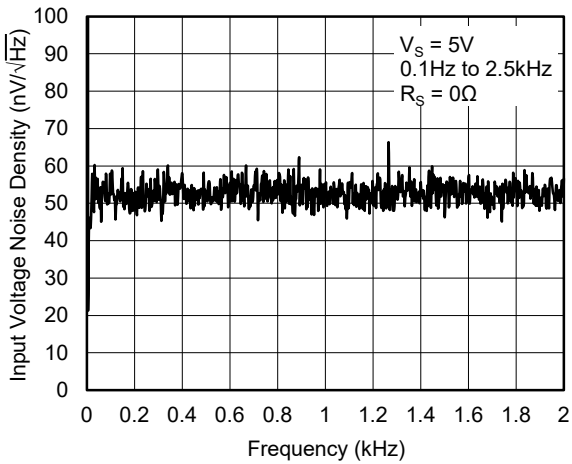

Input Voltage Noise Density vs. Frequency

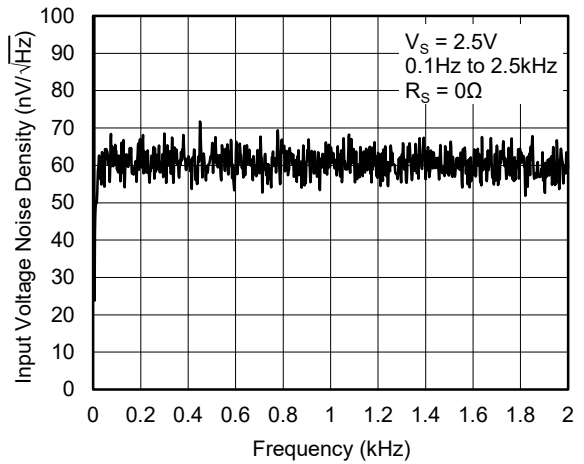

Input Voltage Noise Density vs. Frequency

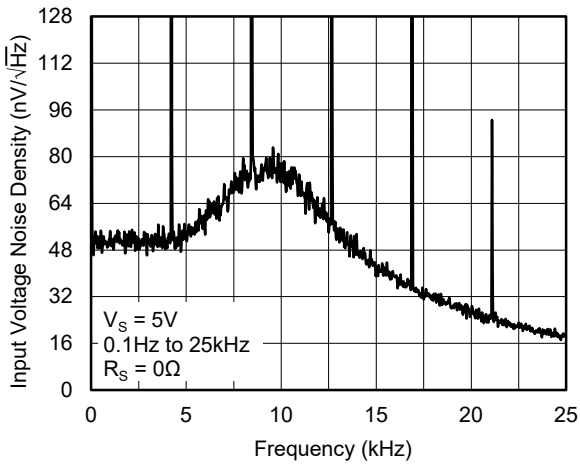

Input Voltage Noise Density vs. Frequency

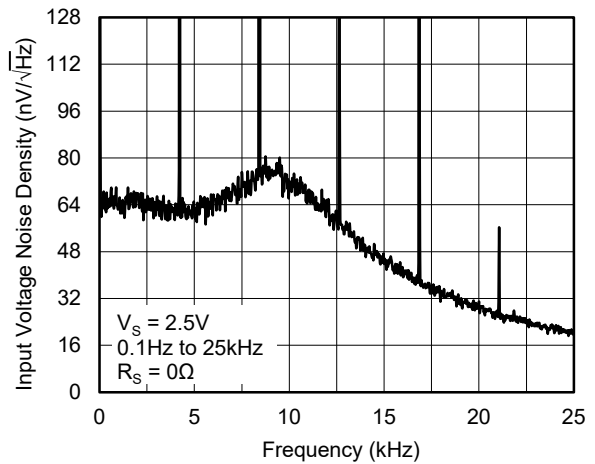

TYPICAL PERFORMANCE CHARACTERISTICS (continued)

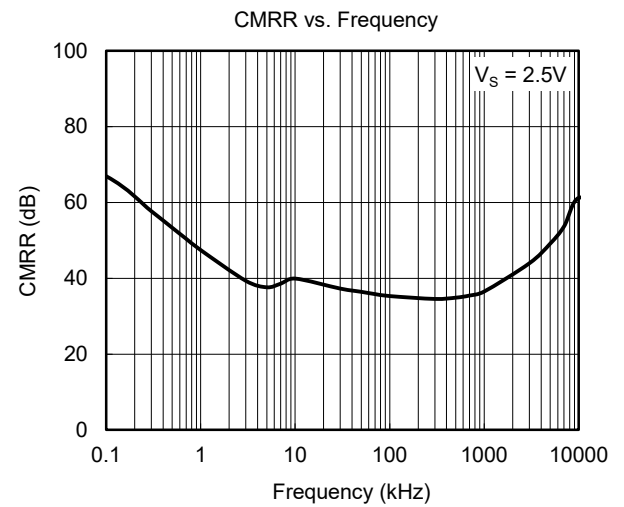
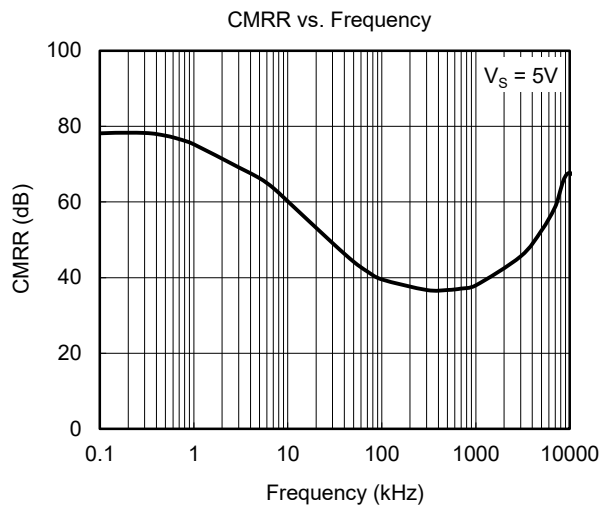
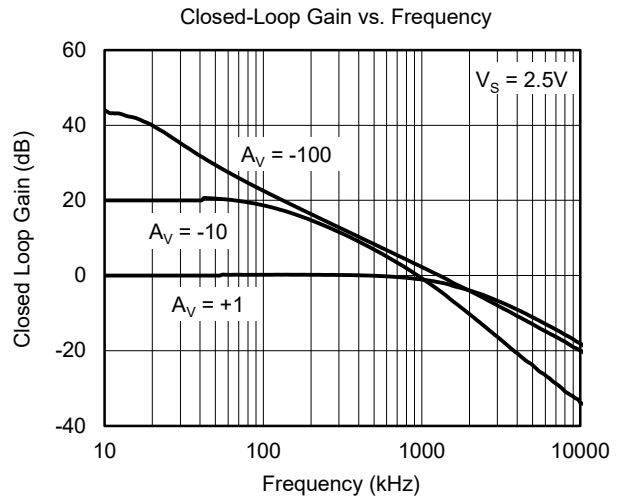
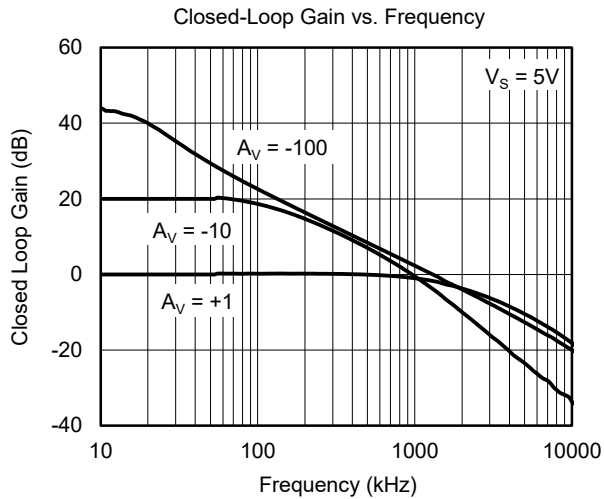
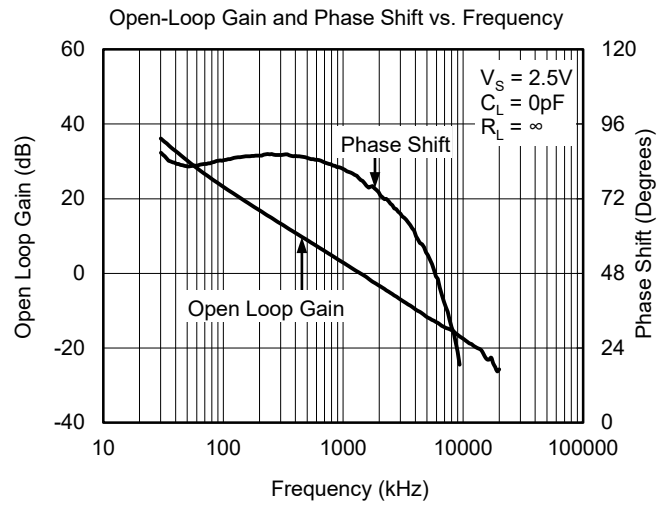
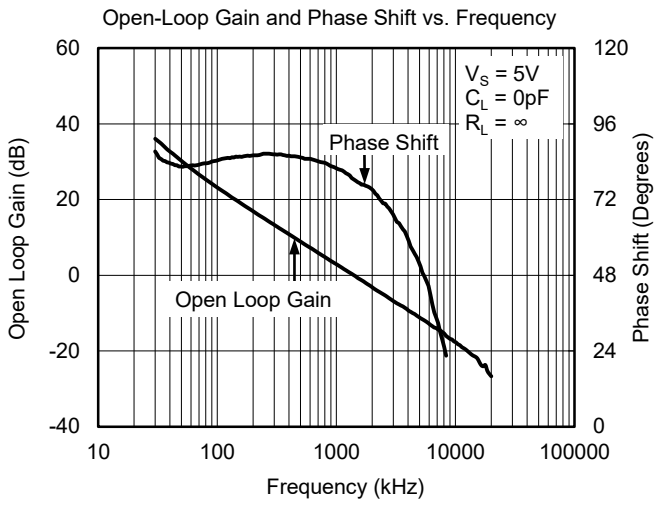

TYPICAL PERFORMANCE CHARACTERISTICS (continued)

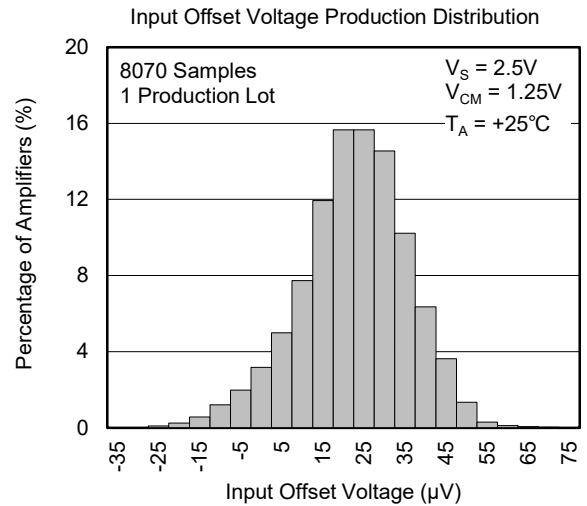
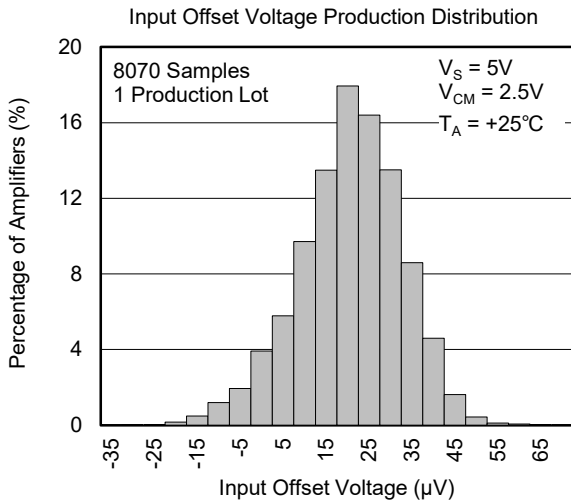
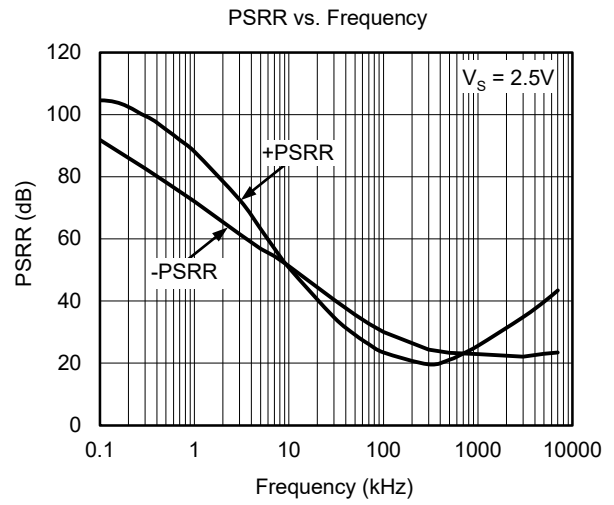
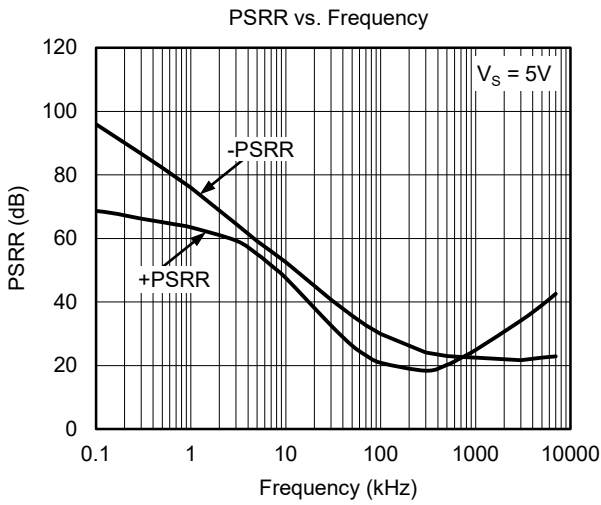

PACKAGE INFORMATION

PACKAGE OUTLINE DIMENSIONS

SOIC-14

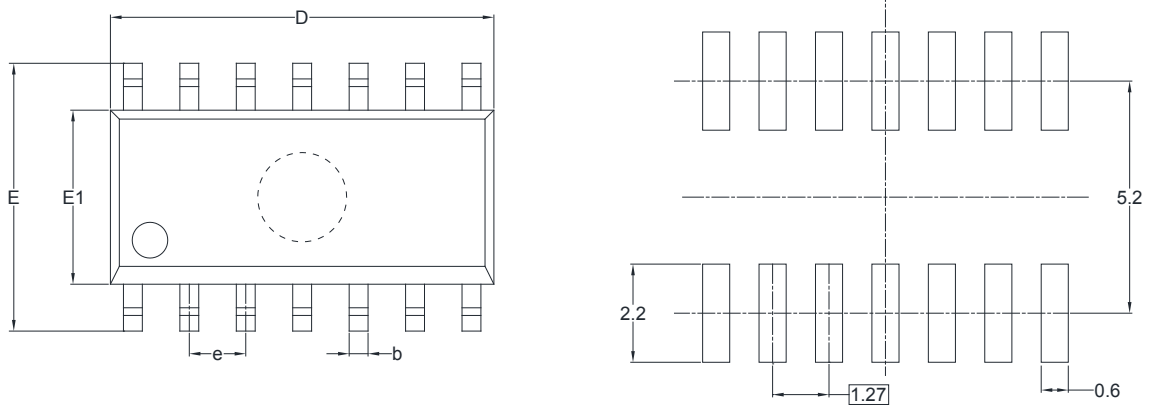

RECOMMENDED LAND PATTERN (Unit: mm)

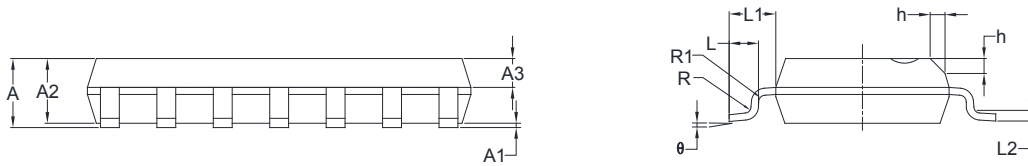

Symbol	Dimensions In Millimeters		Dimensions In Inches	
	MIN	MAX	MIN	MAX
A	1.35	1.75	0.053	0.069
A1	0.10	0.25	0.004	0.010
A2	1.25	1.65	0.049	0.065
A3	0.55	0.75	0.022	0.030
b	0.36	0.49	0.014	0.019
D	8.53	8.73	0.336	0.344
E	5.80	6.20	0.228	0.244
E1	3.80	4.00	0.150	0.157
e	1.27 BSC		0.050 BSC	
L	0.45	0.80	0.018	0.032
L1	1.04 REF		0.040 REF	
L2	0.25 BSC		0.01 BSC	
R	0.07		0.003	
R1	0.07		0.003	
h	0.30	0.50	0.012	0.020
θ	0°	8°	0°	8°

PACKAGE INFORMATION

PACKAGE OUTLINE DIMENSIONS

TSSOP-14

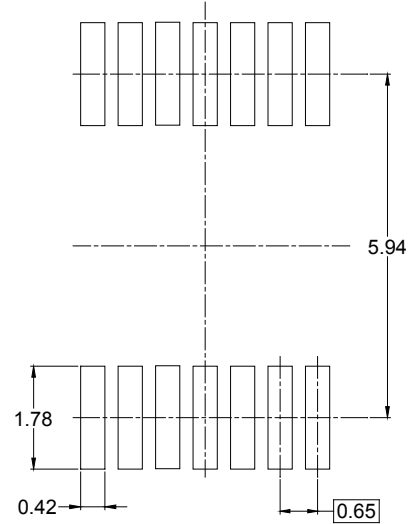
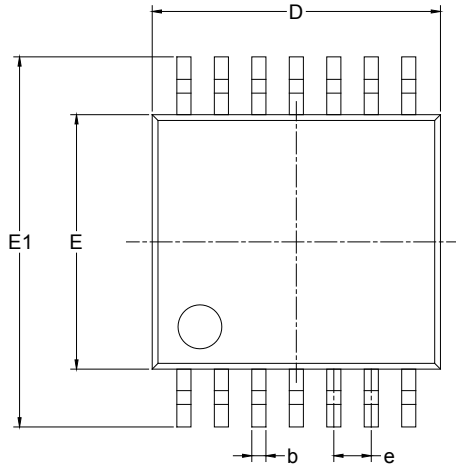

RECOMMENDED LAND PATTERN (Unit: mm)

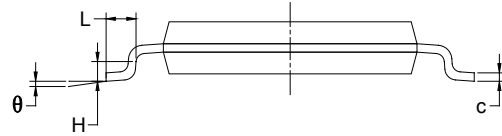
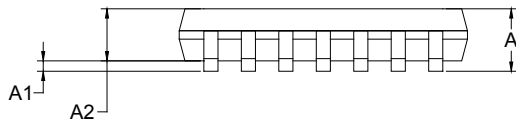

Symbol	Dimensions In Millimeters		Dimensions In Inches	
	MIN	MAX	MIN	MAX
A		1.200		0.047
A1	0.050	0.150	0.002	0.006
A2	0.800	1.050	0.031	0.041
b	0.190	0.300	0.007	0.012
c	0.090	0.200	0.004	0.008
D	4.860	5.100	0.191	0.201
E	4.300	4.500	0.169	0.177
E1	6.250	6.550	0.246	0.258
e	0.650 BSC		0.026 BSC	
L	0.500	0.700	0.02	0.028
H	0.25 TYP		0.01 TYP	
θ	1°	7°	1°	7°

PACKAGE INFORMATION

TAPE AND REEL INFORMATION

REEL DIMENSIONS

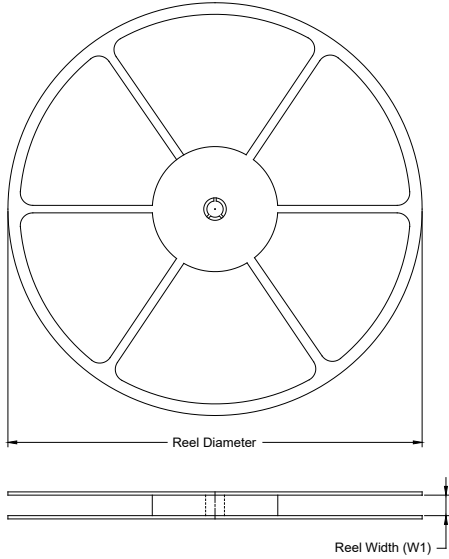

TAPE DIMENSIONS

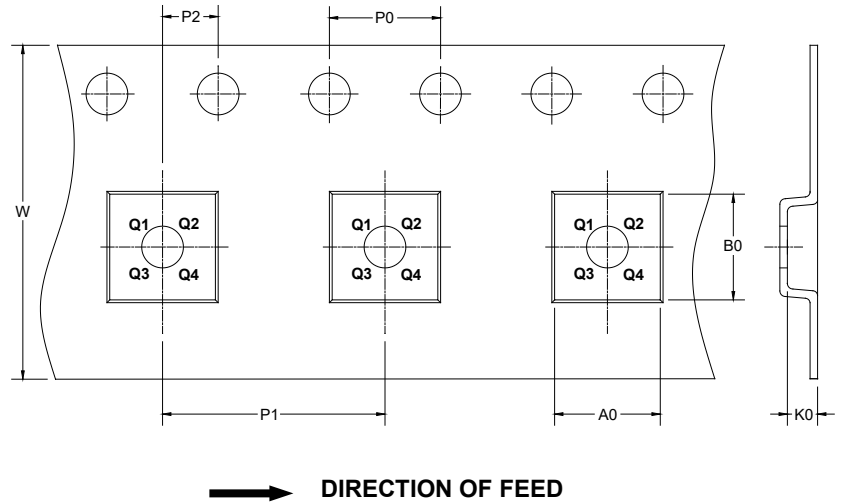

NOTE: The picture is only for reference. Please make the object as the standard.

KEY PARAMETER LIST OF TAPE AND REEL

Package Type	Reel Diameter	Reel Width W1 (mm)	A0 (mm)	B0 (mm)	K0 (mm)	P0 (mm)	P1 (mm)	P2 (mm)	W (mm)	Pin1 Quadrant
SOIC-14	13"	16.4	6.60	9.30	2.10	4.0	8.0	2.0	16.0	Q1
TSSOP-14	13"	12.4	6.95	5.60	1.20	4.0	8.0	2.0	12.0	Q1

DD0001

PACKAGE INFORMATION

CARTON BOX DIMENSIONS



NOTE: The picture is only for reference. Please make the object as the standard.

KEY PARAMETER LIST OF CARTON BOX

Reel Type	Length (mm)	Width (mm)	Height (mm)	Pizza/Carton
13"	386	280	370	5

DD0002