

GENERAL DESCRIPTION

The SGM2033 series are ultra low noise linear regulators capable of supplying 250mA output current. Designed to meet the requirements of RF and analog circuits, the SGM2033 device provides ultra low noise, high PSRR, low quiescent current and very good load/line transients. The device is designed to work with a 1 μ F input and a 1 μ F output ceramic capacitors.

The SGM2033 is available in Green SOT-23-5 and UTDFN-1 \times 1-4AL packages. It operates over an ambient temperature range of -40 $^{\circ}$ C to +125 $^{\circ}$ C.

APPLICATIONS

- Battery-Powered Equipment
- Wireless LAN Devices
- Smart-phones and Tablets
- Cameras and Camcorders

FEATURES

- Operating Input Voltage Range: 1.8V to 5.5V
- Available in Fixed Voltage Option: 1.2V to 5.0V
- Output Short to GND Protection
- Output Current Limit: 500mA (TYP)
- Over-Temperature Protection: +165 $^{\circ}$ C
- Fast Load Transient Response
- Ultra Low Quiescent Current: 13.5 μ A (TYP)
- Shutdown Current: 0.1 μ A (TYP)
- Stable with a 1 μ F Small Case Size Ceramic Capacitor
- -40 $^{\circ}$ C to +125 $^{\circ}$ C Operating Temperature Range
- Available in Green SOT-23-5 and UTDFN-1 \times 1-4AL Packages

TYPICAL APPLICATION

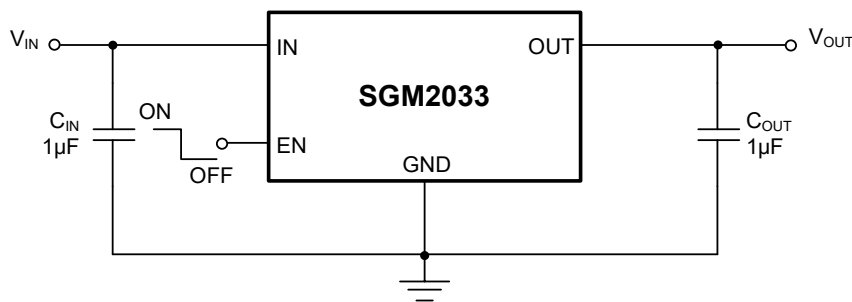

Figure 1. Typical Application Circuit

PACKAGE/ORDERING INFORMATION

MODEL	PACKAGE DESCRIPTION	SPECIFIED TEMPERATURE RANGE	ORDERING NUMBER	PACKAGE MARKING	PACKING OPTION
SGM2033-1.2	SOT-23-5	-40°C to +125°C	SGM2033-1.2XN5G/TR	GP1XX	Tape and Reel, 3000
SGM2033-1.8	SOT-23-5	-40°C to +125°C	SGM2033-1.8XN5G/TR	GTFXX	Tape and Reel, 3000
SGM2033-2.5	SOT-23-5	-40°C to +125°C	SGM2033-2.5XN5G/TR	GU0XX	Tape and Reel, 3000
SGM2033-2.8	SOT-23-5	-40°C to +125°C	SGM2033-2.8XN5G/TR	GU1XX	Tape and Reel, 3000
SGM2033-2.85	SOT-23-5	-40°C to +125°C	SGM2033-2.85XN5G/TR	GU2XX	Tape and Reel, 3000
SGM2033-2.9	SOT-23-5	-40°C to +125°C	SGM2033-2.9XN5G/TR	GU3XX	Tape and Reel, 3000
SGM2033-2.95	SOT-23-5	-40°C to +125°C	SGM2033-2.95XN5G/TR	GU4XX	Tape and Reel, 3000
SGM2033-3.0	SOT-23-5	-40°C to +125°C	SGM2033-3.0XN5G/TR	GU5XX	Tape and Reel, 3000
SGM2033-3.3	SOT-23-5	-40°C to +125°C	SGM2033-3.3XN5G/TR	GU6XX	Tape and Reel, 3000
SGM2033-4.2	SOT-23-5	-40°C to +125°C	SGM2033-4.2XN5G/TR	GP5XX	Tape and Reel, 3000
SGM2033-5.0	SOT-23-5	-40°C to +125°C	SGM2033-5.0XN5G/TR	GU7XX	Tape and Reel, 3000
SGM2033-1.2	UTDFN-1×1-4AL	-40°C to +125°C	SGM2033-1.2XUDH4G/TR	63X	Tape and Reel, 10000
SGM2033-1.8	UTDFN-1×1-4AL	-40°C to +125°C	SGM2033-1.8XUDH4G/TR	U8X	Tape and Reel, 10000
SGM2033-2.5	UTDFN-1×1-4AL	-40°C to +125°C	SGM2033-2.5XUDH4G/TR	U9X	Tape and Reel, 10000
SGM2033-2.8	UTDFN-1×1-4AL	-40°C to +125°C	SGM2033-2.8XUDH4G/TR	UAX	Tape and Reel, 10000
SGM2033-2.85	UTDFN-1×1-4AL	-40°C to +125°C	SGM2033-2.85XUDH4G/TR	UBX	Tape and Reel, 10000
SGM2033-2.9	UTDFN-1×1-4AL	-40°C to +125°C	SGM2033-2.9XUDH4G/TR	UCX	Tape and Reel, 10000
SGM2033-2.95	UTDFN-1×1-4AL	-40°C to +125°C	SGM2033-2.95XUDH4G/TR	UDX	Tape and Reel, 10000
SGM2033-3.0	UTDFN-1×1-4AL	-40°C to +125°C	SGM2033-3.0XUDH4G/TR	UEX	Tape and Reel, 10000
SGM2033-3.3	UTDFN-1×1-4AL	-40°C to +125°C	SGM2033-3.3XUDH4G/TR	UFX	Tape and Reel, 10000
SGM2033-4.2	UTDFN-1×1-4AL	-40°C to +125°C	SGM2033-4.2XUDH4G/TR	61X	Tape and Reel, 10000
SGM2033-5.0	UTDFN-1×1-4AL	-40°C to +125°C	SGM2033-5.0XUDH4G/TR	V0X	Tape and Reel, 10000

MARKING INFORMATION

NOTE: XX = Date Code. X = Date Code.

SOT-23-5

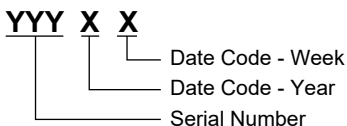

UTDFN-1×1-4AL

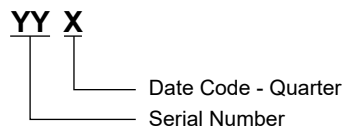

Green (RoHS & HSF): SG Micro Corp defines "Green" to mean Pb-Free (RoHS compatible) and free of halogen substances. If you have additional comments or questions, please contact your SGMICRO representative directly.

ABSOLUTE MAXIMUM RATINGS

IN to GND -0.3V to 6V
 OUT to GND -0.3V to (V_{IN} + 0.3V)
 EN to GND -0.3V to 6V
 Package Thermal Resistance
 SOT-23-5, θ_{JA} 207°C/W
 UTDFN-1×1-4AL, θ_{JA} 238°C/W
 Junction Temperature +150°C
 Storage Temperature Range -65°C to +150°C
 Lead Temperature (Soldering, 10s) +260°C
 ESD Susceptibility
 HBM 8000V
 MM 400V
 CDM 1000V

RECOMMENDED OPERATING CONDITIONS

Input Voltage Range 1.8V to 5.5V
 Operating Temperature Range -40°C to +125°C

OVERSTRESS CAUTION

Stresses beyond those listed in Absolute Maximum Ratings may cause permanent damage to the device. Exposure to absolute maximum rating conditions for extended periods may affect reliability. Functional operation of the device at any conditions beyond those indicated in the Recommended Operating Conditions section is not implied.

ESD SENSITIVITY CAUTION

This integrated circuit can be damaged by ESD if you don't pay attention to ESD protection. SGMICRO recommends that all integrated circuits be handled with appropriate precautions. Failure to observe proper handling and installation procedures can cause damage. ESD damage can range from subtle performance degradation to complete device failure. Precision integrated circuits may be more susceptible to damage because very small parametric changes could cause the device not to meet its published specifications.

DISCLAIMER

SG Micro Corp reserves the right to make any change in circuit design, or specifications without prior notice.

PIN CONFIGURATIONS

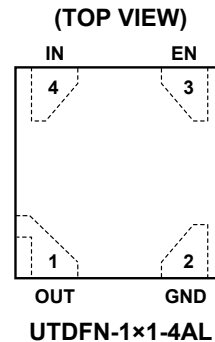
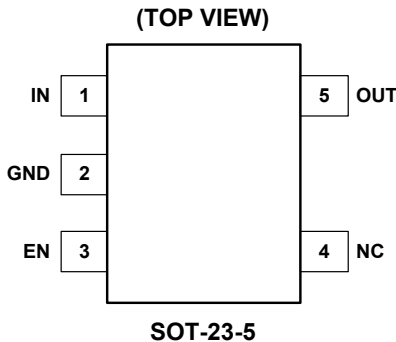

PIN DESCRIPTION

PIN		NAME	FUNCTION
SOT-23-5	UTDFN-1×1-4AL		
1	4	IN	Input Voltage Supply Pin.
2	2	GND	Common Ground Connection.
3	3	EN	Chip Enable. Applying V _{EN} ≤ 0.4V disables the regulator; pulling V _{EN} ≥ 1.5V enables the LDO.
4	–	NC	Not Connected.
5	1	OUT	Regulated Output Voltage. It is recommended to use output capacitor with effective capacitance in the range of 1µF to 10µF.

ELECTRICAL CHARACTERISTICS

($V_{IN} = V_{OUT(NOM)} + 1.0V$, $I_{OUT} = 0.1mA$, $V_{EN} = V_{IN}$, $C_{IN} = C_{OUT} = 1\mu F$, Full = $-40^{\circ}C$ to $+125^{\circ}C$, typical values are at $T_A = +25^{\circ}C$, unless otherwise noted.)

PARAMETER	SYMBOL	CONDITIONS		TEMP	MIN	TYP	MAX	UNITS
Operating Input Voltage Range	V_{IN}			Full	1.8		5.5	V
Output Voltage Accuracy	V_{OUT}	$V_{IN} = (V_{OUT(NOM)} + 1.0V)$ to 5.5V		+25°C	1		1	%
				Full	1.5		1.5	
Line Regulation	$\frac{\Delta V_{OUT}}{\Delta V_{IN} \times V_{OUT}}$	$V_{IN} = (V_{OUT(NOM)} + 1.0V)$ to 5.5V	$V_{OUT(NOM)} \leq 3.3V$	Full		0.01	0.12	%V
			$V_{OUT(NOM)} = 4.2V$	Full		0.04	0.36	
Load Regulation	ΔV_{OUT}	$I_{OUT} = 0.1mA$ to 250mA	$V_{OUT(NOM)} \leq 1.8V$	+25°C		3		mV
			$V_{OUT(NOM)} > 1.8V$	+25°C		7		
Dropout Voltage ⁽¹⁾	V_{DROP}	$I_{OUT} = 250mA$, SOT-23-5	$1.8V \leq V_{OUT(NOM)} < 2.8V$	Full		175	265	mV
			$2.8V \leq V_{OUT(NOM)} < 3.3V$	Full		120	200	
			$3.3V \leq V_{OUT(NOM)} < 4.2V$	Full		105	180	
			$4.2V \leq V_{OUT(NOM)} \leq 5.0V$	Full		95	155	
Dropout Voltage ⁽¹⁾	V_{DROP}	$I_{OUT} = 250mA$, UTDFN-1x1-4AL	$1.8V \leq V_{OUT(NOM)} < 2.8V$	Full		145	225	mV
			$2.8V \leq V_{OUT(NOM)} < 3.3V$	Full		85	145	
			$3.3V \leq V_{OUT(NOM)} < 4.2V$	Full		72	125	
			$4.2V \leq V_{OUT(NOM)} \leq 5.0V$	Full		62	110	
Output Current Limit ⁽²⁾	I_{LIM}			+25°C	260	500		mA
Short Circuit Current	I_{SC}	$V_{OUT} = 0V$		+25°C		220		mA
Quiescent Current	I_Q	No load		Full		13.5	22	μA
Shutdown Current	I_{SHDN}	$V_{EN} = 0V$, $V_{IN} = 5.5V$		+25°C		0.1	1	μA
				Full			2.5	
EN Pin Threshold Voltage	V_{IH}	EN input voltage high		Full	1.5			V
	V_{IL}	EN input voltage low		Full			0.4	
EN Pull-Down Current	I_{EN}	$V_{EN} = 5.5V$		Full		0.2	1	μA
Turn-On Time	t_{ON}	From assertion of V_{EN} to $V_{OUT} = 90\% V_{OUT(NOM)}$		+25°C		120		μs
Power Supply Rejection Ratio	PSRR	$I_{OUT} = 20mA$		$f = 100Hz$	+25°C		84	dB
				$f = 1kHz$	+25°C		94	
				$f = 10kHz$	+25°C		73	
				$f = 100kHz$	+25°C		33	
Output Voltage Noise	e_n	$f = 10Hz$ to 100kHz $V_{OUT} = 2.8V$		$I_{OUT} = 1mA$	+25°C		26	μV_{RMS}
				$I_{OUT} = 250mA$	+25°C		20	
Output Discharge Resistance	R_{DISCH}	$V_{EN} \leq 0.4V$, $V_{IN} = 5.0V$		+25°C		220		Ω
Thermal Shutdown Temperature	T_{SHDN}					165		$^{\circ}C$
Thermal Shutdown Hysteresis	ΔT_{SHDN}					20		$^{\circ}C$

NOTES:

- Dropout voltage is characterized when V_{OUT} falls 5% below $V_{OUT(NOM)}$.
- Output current limit is characterized when V_{OUT} falls 200mV below $V_{OUT(NOM)}$.

TYPICAL PERFORMANCE CHARACTERISTICS

$T_A = +25^\circ\text{C}$, $V_{IN} = V_{OUT(NOM)} + 1.0\text{V}$, $V_{EN} = V_{IN}$, $C_{IN} = C_{OUT} = 1\mu\text{F}$, unless otherwise noted.

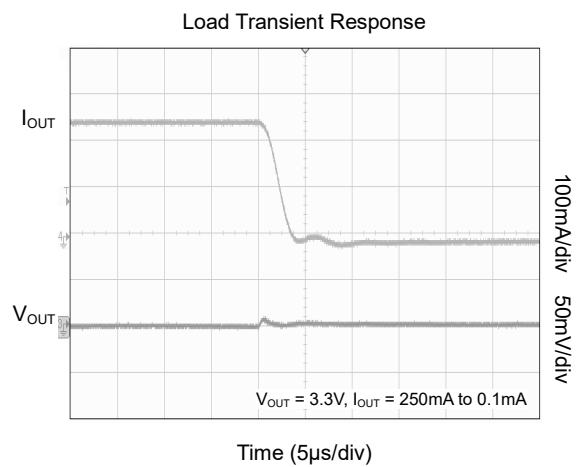
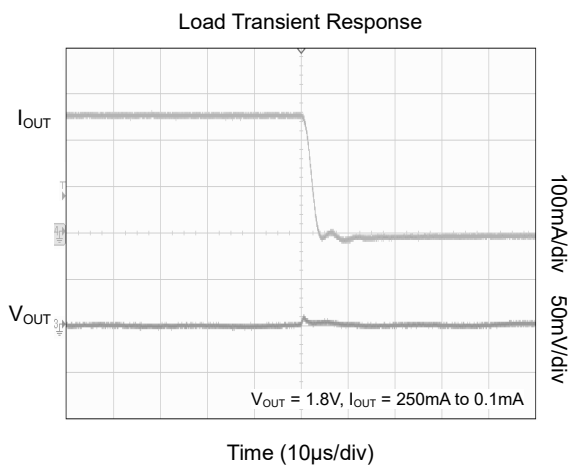
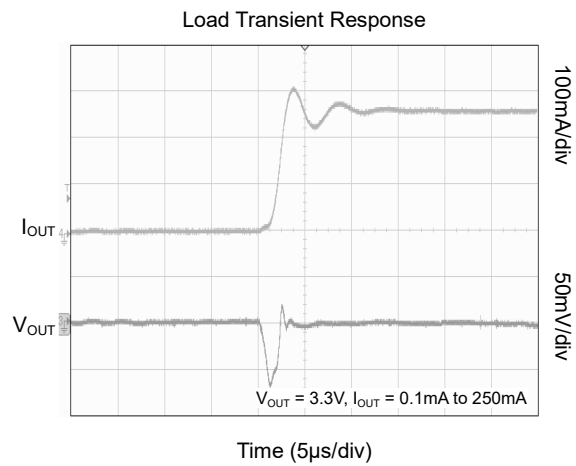
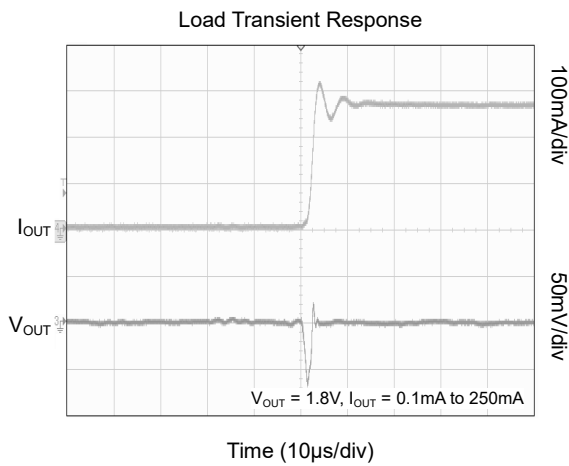
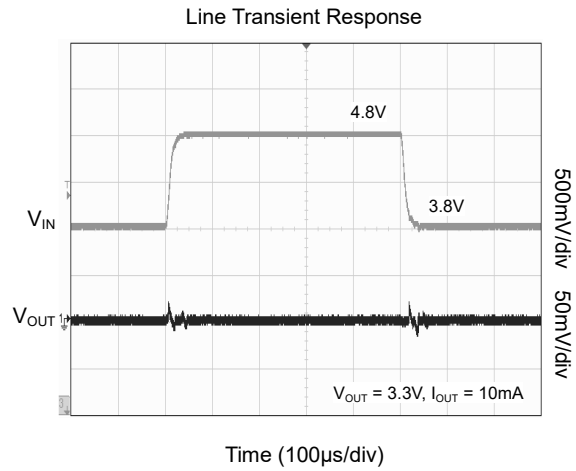
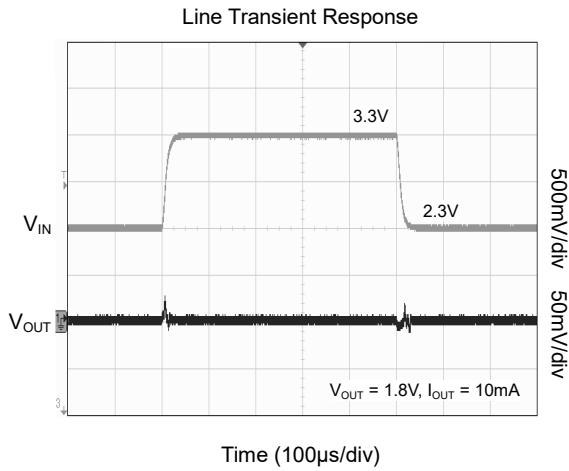

TYPICAL PERFORMANCE CHARACTERISTICS (continued)

$T_A = +25^\circ\text{C}$, $V_{IN} = V_{OUT(NOM)} + 1.0\text{V}$, $V_{EN} = V_{IN}$, $C_{IN} = C_{OUT} = 1\mu\text{F}$, unless otherwise noted.

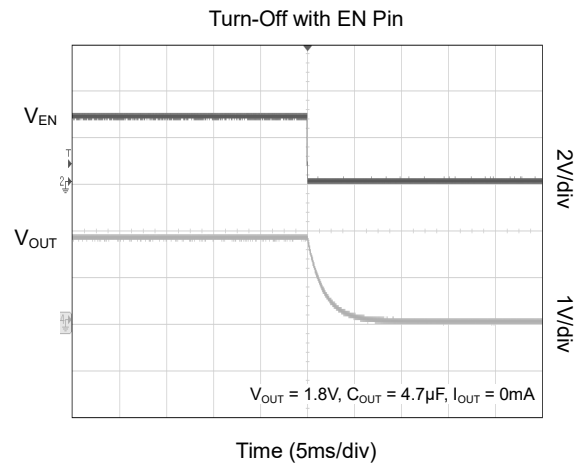
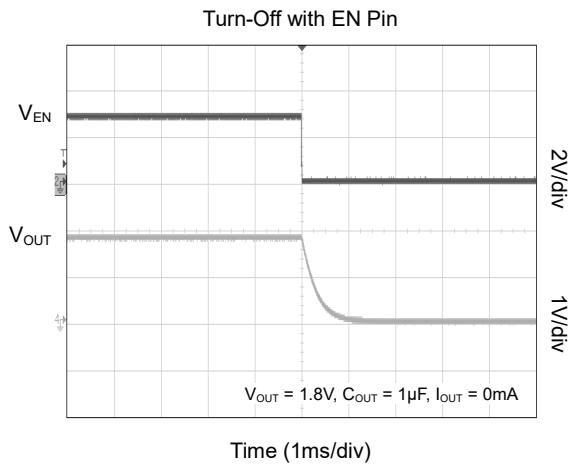
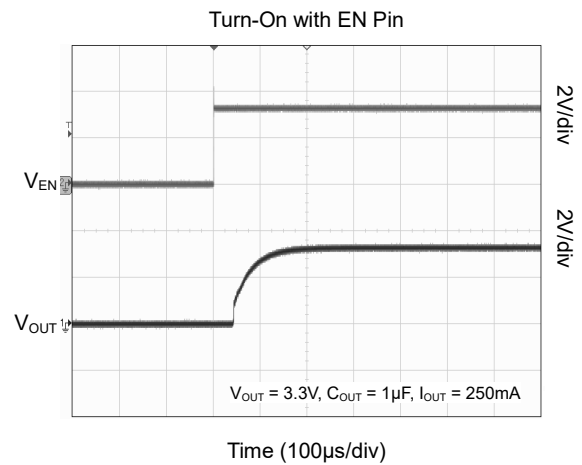
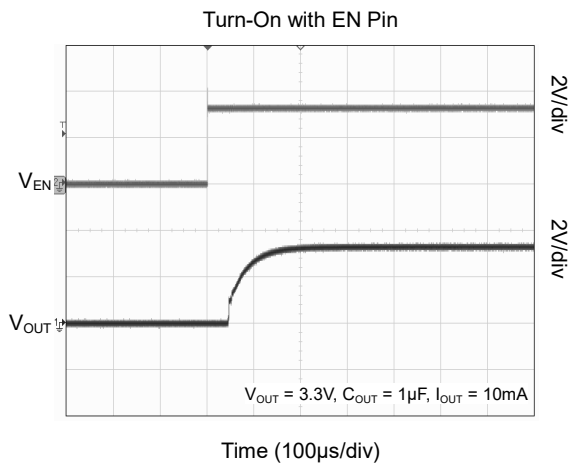
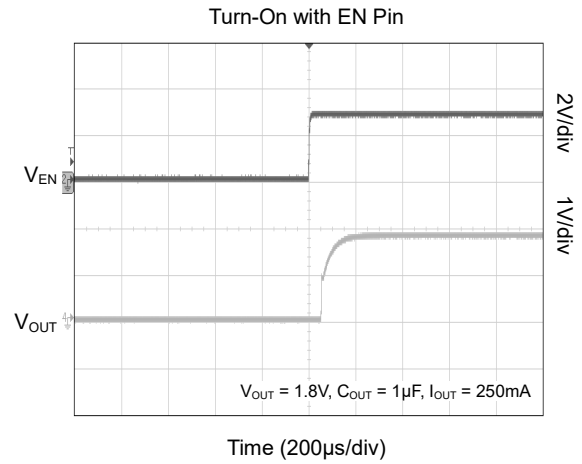
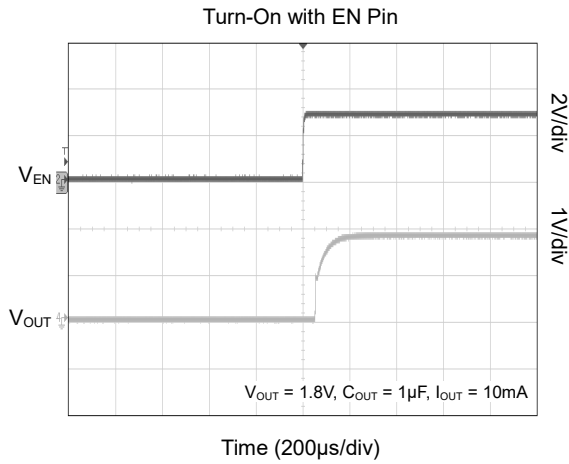

TYPICAL PERFORMANCE CHARACTERISTICS (continued)

$T_A = +25^\circ\text{C}$, $V_{IN} = V_{OUT(NOM)} + 1.0\text{V}$, $V_{EN} = V_{IN}$, $C_{IN} = C_{OUT} = 1\mu\text{F}$, unless otherwise noted.

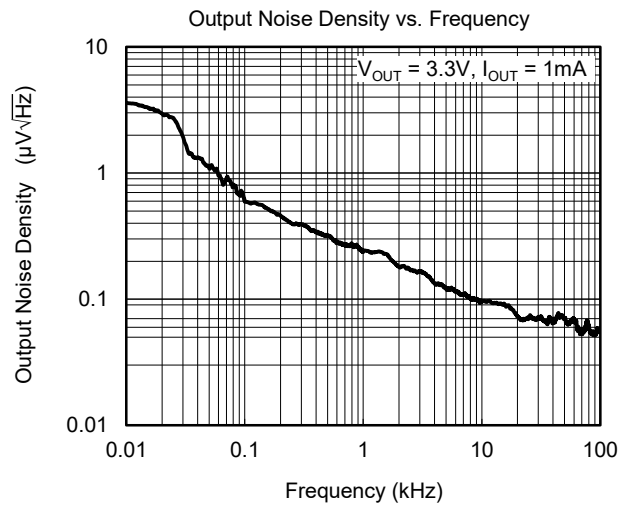
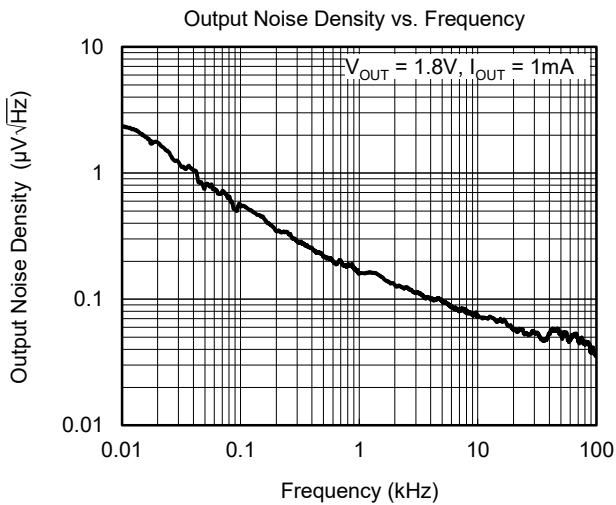
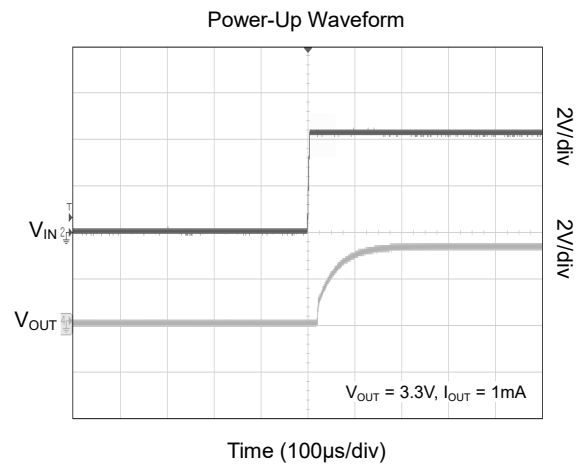
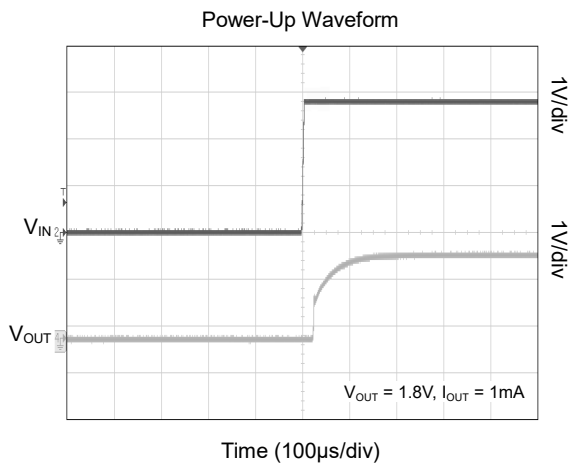
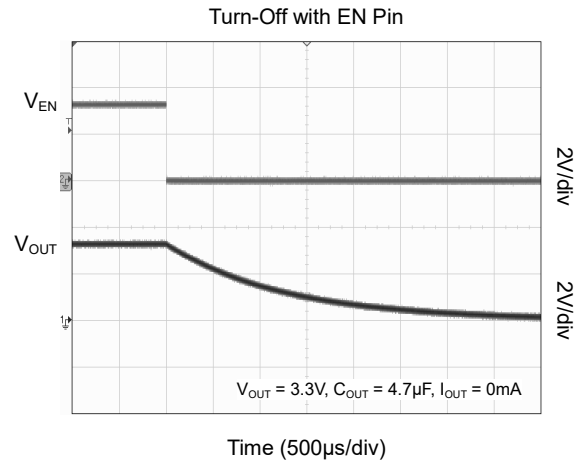
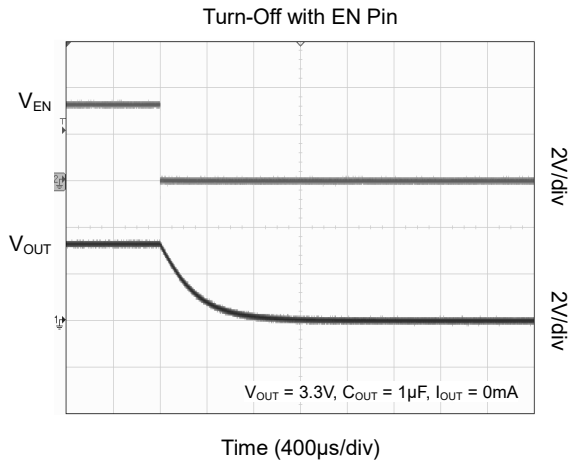

TYPICAL PERFORMANCE CHARACTERISTICS (continued)

$T_A = +25^\circ\text{C}$, $V_{IN} = V_{OUT(NOM)} + 1.0\text{V}$, $V_{EN} = V_{IN}$, $C_{IN} = C_{OUT} = 1\mu\text{F}$, unless otherwise noted.

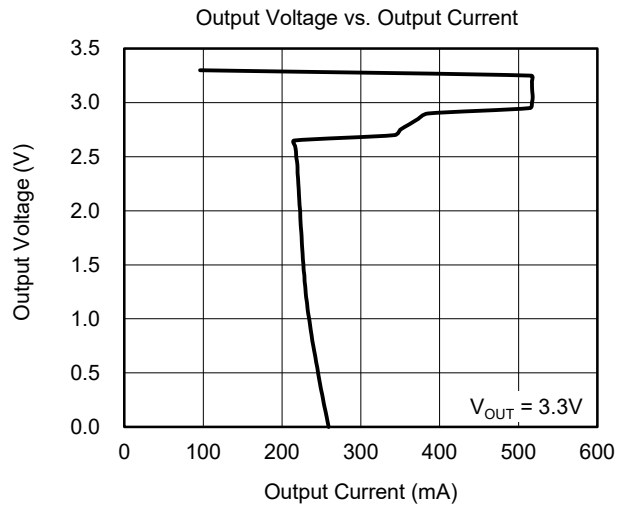
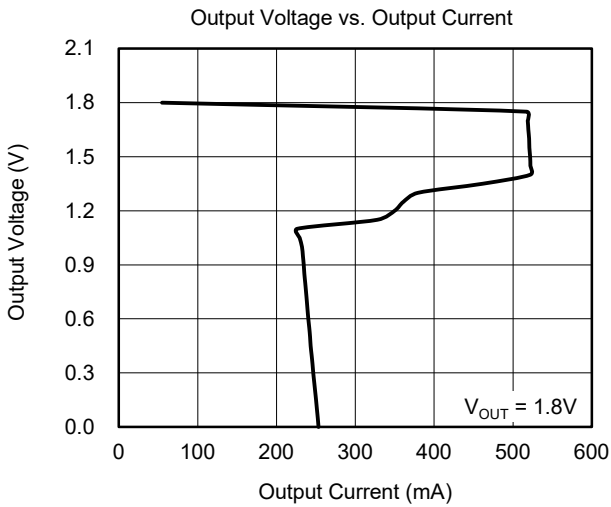
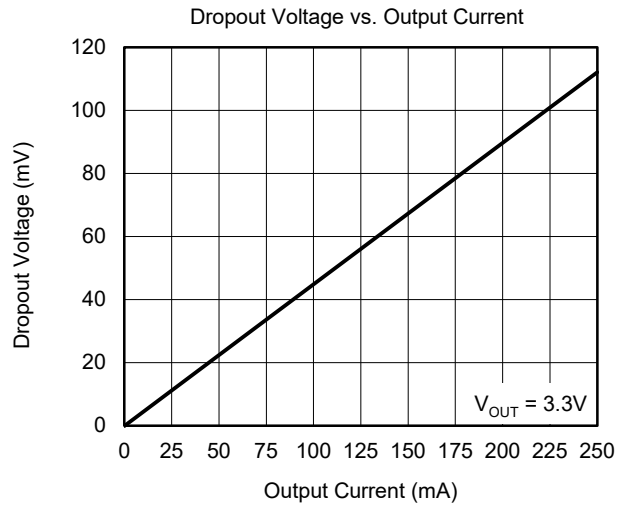
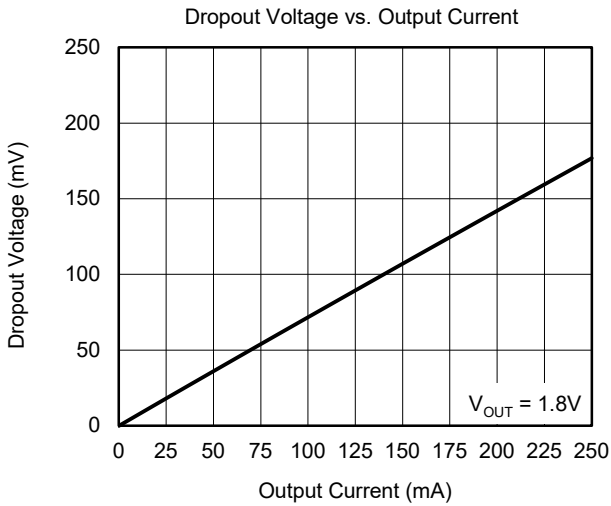
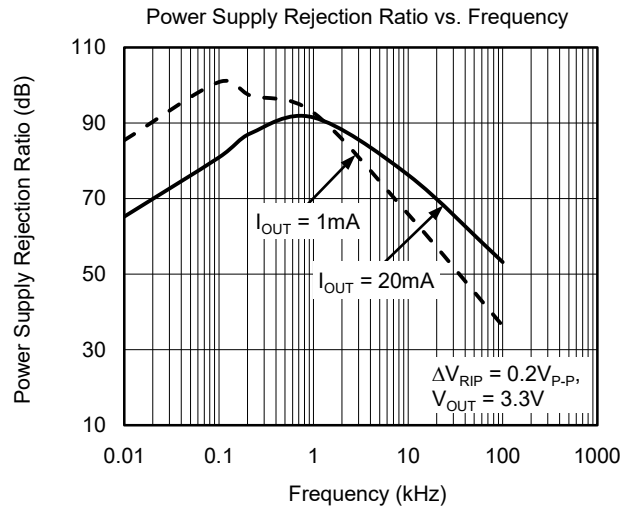
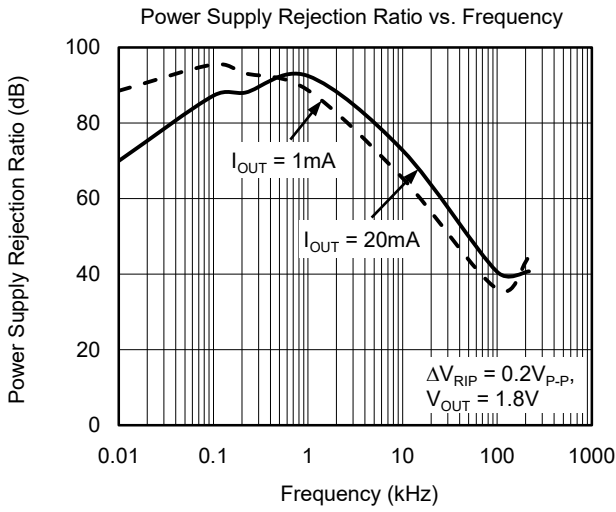

TYPICAL PERFORMANCE CHARACTERISTICS (continued)

$T_A = +25^\circ\text{C}$, $V_{IN} = V_{OUT(NOM)} + 1.0\text{V}$, $V_{EN} = V_{IN}$, $C_{IN} = C_{OUT} = 1\mu\text{F}$, unless otherwise noted.

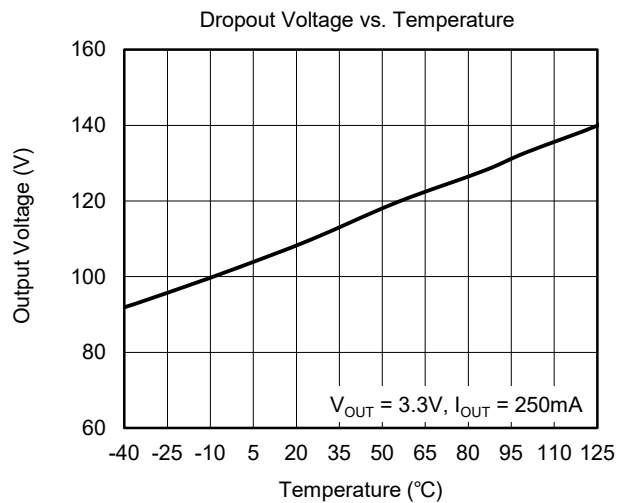
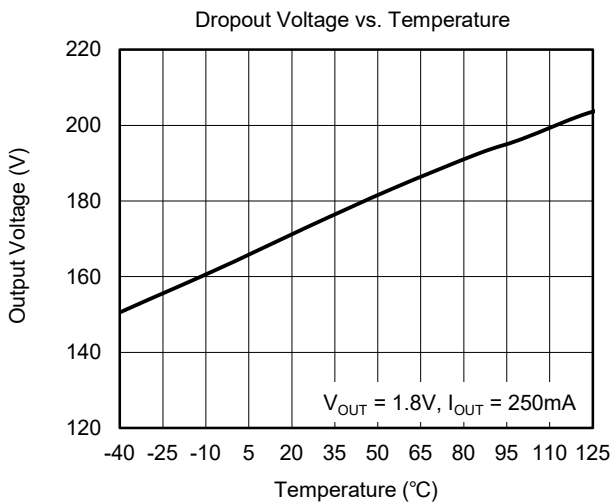
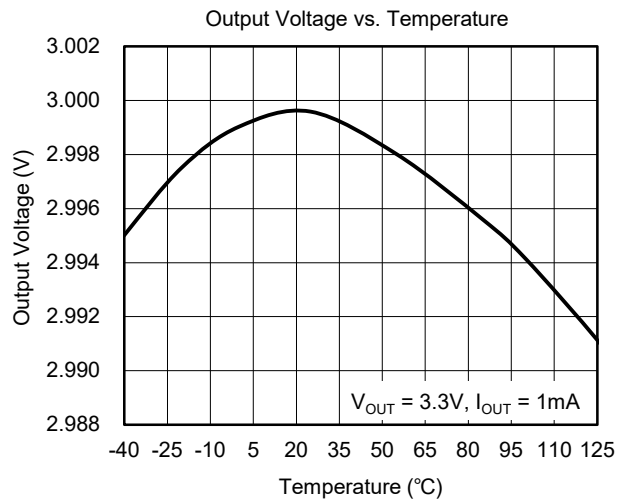
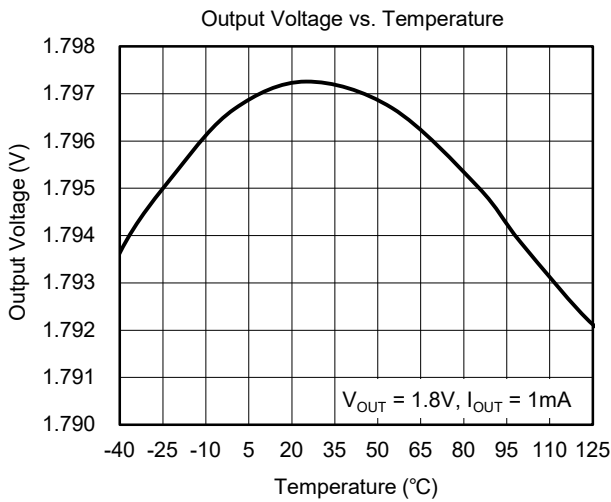
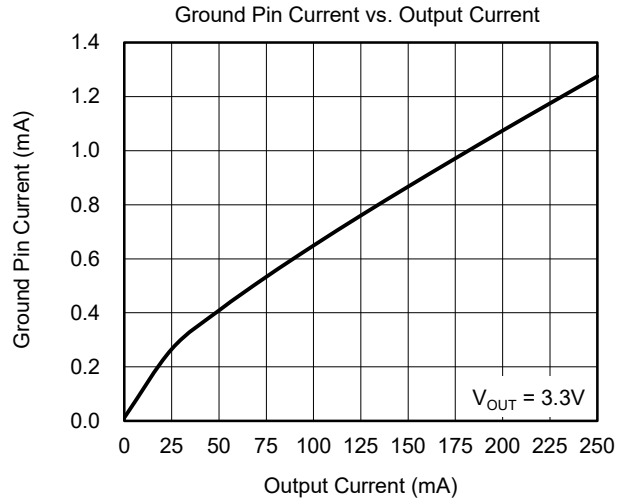
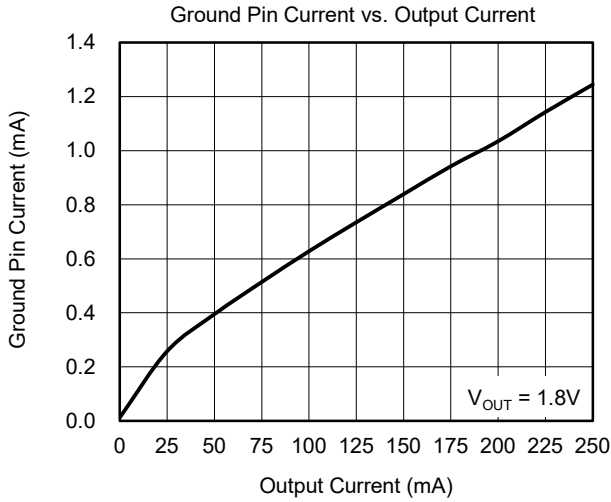

FUNCTIONAL BLOCK DIAGRAM

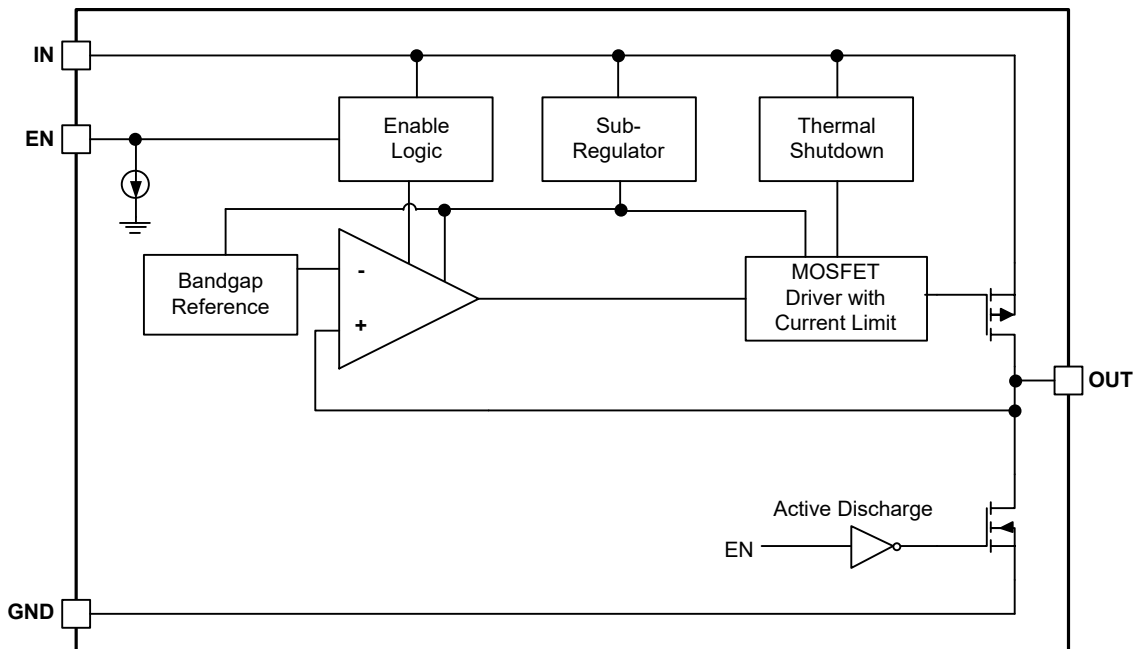

Figure 2. Block Diagram

APPLICATION INFORMATION

The SGM2033 series are ultra low noise 250mA low dropout regulators designed to meet the requirements of RF applications and high performance analog circuits. The SGM2033 device provides very high PSRR and excellent dynamic response. In connection with low quiescent current this device is well suitable for battery powered application such as cell phones, tablets and others. The SGM2033 is fully protected in case of current overload, output short circuit and overheating.

Input Capacitor Selection (C_{IN})

Input capacitor connected as close as possible is necessary for ensuring device stability. The X7R or X5R capacitor should be used for reliable performance over temperature range. The value of the input capacitor should be $1\mu\text{F}$ or greater to ensure the best dynamic performance. This capacitor will provide a low impedance path for unwanted AC signals or noise modulated onto constant input voltage. There is no requirement for the ESR of the input capacitor but it is recommended to use ceramic capacitors for their low ESR and ESL. A good input capacitor will limit the influence of input trace inductance and source resistance during sudden load current changes.

Enable Operation

The SGM2033 uses the EN pin to enable/disable its device and to deactivate/activate the active discharge function.

If the EN pin voltage is $\leq 0.4\text{V}$ the device is guaranteed to be disabled. The pass transistor is turned off so that there is virtually no current flow between the IN and OUT. The active discharge transistor is active so that the output voltage V_{OUT} is pulled to GND through a 220Ω resistor. In the disable state the device consumes as low as typical $0.1\mu\text{A}$ from the V_{IN} .

If the EN pin voltage $\geq 1.5\text{V}$ the device is guaranteed to be enabled. The SGM2033 regulates the output voltage and the active discharge transistor is turned off.

The EN pin has internal pull-down current source with typical value of $0.2\mu\text{A}$ which ensures that the device is turned off when the EN pin is not connected. In the case where the EN function isn't required the EN should be tied directly to IN.

Output Current Limit

Output current is internally limited within the IC to a typical 500mA. The SGM2033 will source this amount of current measured with a voltage drop on the 90% of the nominal V_{OUT} . If the output voltage is directly shorted to ground ($V_{OUT} = 0\text{V}$), the short circuit protection will limit the output current to 220mA (TYP). The current limit and short circuit protection will work properly over whole temperature range and also input voltage range. There is no limitation for the short circuit duration.

Power Dissipation

As power dissipated in the SGM2033 increases, it might become necessary to provide some thermal relief. The maximum power dissipation supported by the device is dependent upon board design and layout. Mounting pad configuration on the PCB, the board material, and the ambient temperature affect the rate of junction temperature rise for the part.

Reverse Current

The PMOS pass transistor has an inherent body diode which will be forward biased in the case that $V_{OUT} > V_{IN}$. Due to this fact, in cases where the extended reverse current condition can be anticipated the device may require additional external protection.

Power Supply Rejection Ratio

The SGM2033 features very high power supply rejection ratio. If desired the PSRR at higher frequencies in the range from 100kHz to 10MHz can be tuned by the selection of C_{OUT} capacitor and proper PCB layout.

Turn-On Time

The turn-on time is defined as the time period from EN assertion to the point in which V_{OUT} will reach 90% of its nominal value.

PCB Layout Recommendations

To obtain good transient performance and good regulation characteristics, place input and output capacitors close to the device pins and make the PCB traces wide. In order to minimize the solution size, use 0402 or 0201 capacitors with appropriate capacity. Larger copper area connected to the pins will also improve the device thermal resistance. Exposed pad can be tied to the GND pin for improved power dissipation and lower device temperature.

REVISION HISTORY

NOTE: Page numbers for previous revisions may differ from page numbers in the current version.

Changes from Original (NOVEMBER 2018) to REV.A

Changed from product preview to production data.....All

PACKAGE OUTLINE DIMENSIONS

SOT-23-5

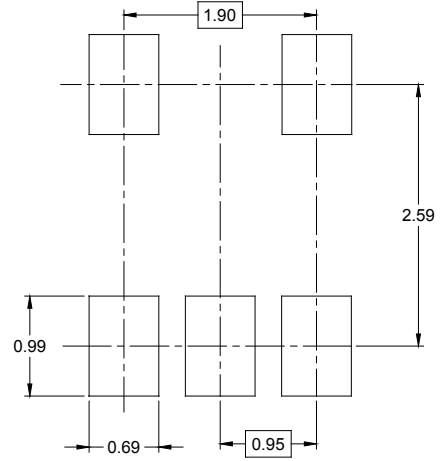
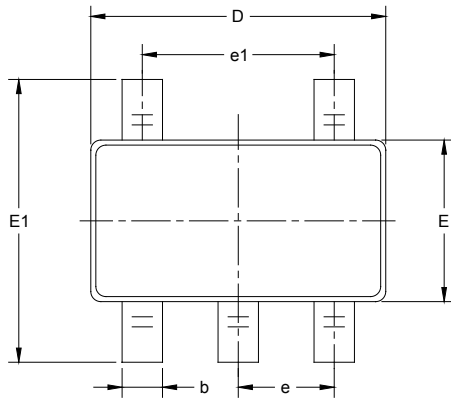

RECOMMENDED LAND PATTERN (Unit: mm)

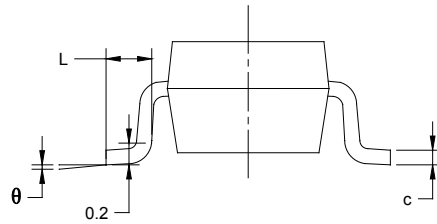
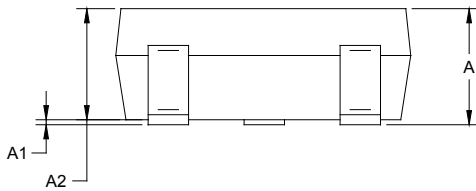

Symbol	Dimensions In Millimeters		Dimensions In Inches	
	MIN	MAX	MIN	MAX
A	1.050	1.250	0.041	0.049
A1	0.000	0.100	0.000	0.004
A2	1.050	1.150	0.041	0.045
b	0.300	0.500	0.012	0.020
c	0.100	0.200	0.004	0.008
D	2.820	3.020	0.111	0.119
E	1.500	1.700	0.059	0.067
E1	2.650	2.950	0.104	0.116
e	0.950 BSC		0.037 BSC	
e1	1.900 BSC		0.075 BSC	
L	0.300	0.600	0.012	0.024
θ	0°	8°	0°	8°

PACKAGE OUTLINE DIMENSIONS

UTDFN-1x1-4AL

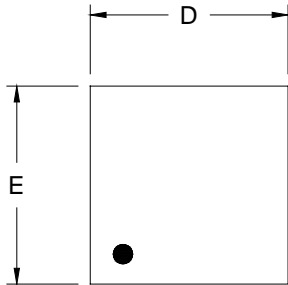

TOP VIEW

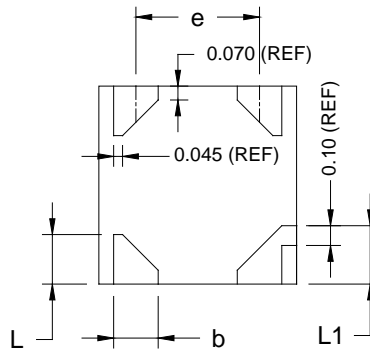

BOTTOM VIEW

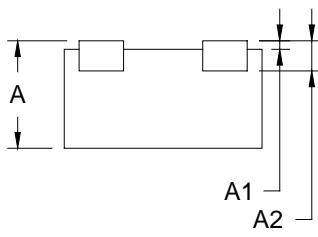

SIDE VIEW

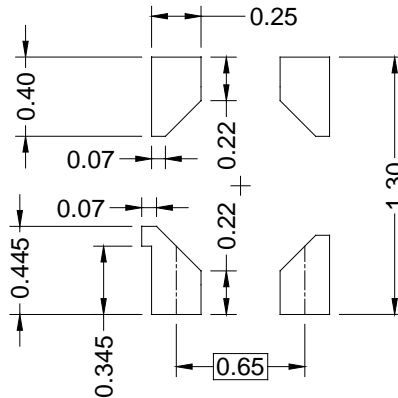

RECOMMENDED LAND PATTERN (Unit: mm)

Symbol	Dimensions In Millimeters		
	MIN	MOD	MAX
A	0.500	0.550	0.600
A1	0.000		0.050
A2	0.152 REF		
e	0.625 BSC		
D	0.950	1.000	1.050
E	0.950	1.000	1.050
b	0.175	0.225	0.275
L	0.200	0.250	0.300
L1	0.245	0.295	0.345

PACKAGE INFORMATION

TAPE AND REEL INFORMATION

REEL DIMENSIONS

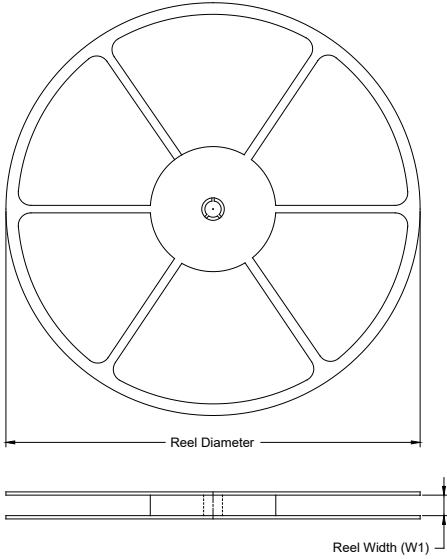

TAPE DIMENSIONS



NOTE: The picture is only for reference. Please make the object as the standard.

KEY PARAMETER LIST OF TAPE AND REEL

Package Type	Reel Diameter	Reel Width W1 (mm)	A0 (mm)	B0 (mm)	K0 (mm)	P0 (mm)	P1 (mm)	P2 (mm)	W (mm)	Pin1 Quadrant
SOT-23-5	7"	9.5	3.20	3.20	1.40	4.0	4.0	2.0	8.0	Q3
UTDFN-1×1-4AL	7"	9.0	1.16	1.16	0.63	4.0	2.0	2.0	8.0	Q1

000001

PACKAGE INFORMATION

CARTON BOX DIMENSIONS



NOTE: The picture is only for reference. Please make the object as the standard.

KEY PARAMETER LIST OF CARTON BOX

Reel Type	Length (mm)	Width (mm)	Height (mm)	Pizza/Carton
7" (Option)	368	227	224	8
7"	442	410	224	18

DD0002