



SGM8701

Micro-Power, CMOS Input, RRIO, 1.4V, Push-Pull Output Comparator

GENERAL DESCRIPTION

The SGM8701 is an ultra low power comparator with a typical power supply current of 300nA. It has the best-in-class power supply current versus propagation delay performance. The propagation delay is as low as 6 μ s with 100mV overdrive at 1.4V supply.

Designed to operate over a wide range of supply voltages, from 1.4V to 5.5V, with guaranteed operation at 1.4V, 2.5V and 5.0V, the SGM8701 is ideal for use in a variety of battery-powered applications. With rail-to-rail common mode voltage range, the SGM8701 is well suited for single-supply operation. Its small packages make this device ideal for use in handheld electronics and mobile phone applications.

Featuring a push-pull output stage, the SGM8701 allows for operation with absolute minimum power consumption when driving any capacitive or resistive load.

SGM8701 is available in Green SOT-23-5 and SC70-5 space-saving packages. It is rated over the -40°C to +85°C temperature range.

FEATURES

- **Ultra Low Power Consumption:**
300nA (TYP) at $V_S = 1.4V$
- **Wide Supply Voltage Range: 1.4V to 5.5V**
- **Propagation Delay: 6 μ s (TYP) at $V_S = 1.4V$**
- **Push-Pull Output Current Drive:**
19mA (TYP) at $V_S = 5V$
- **Rail-to-Rail Input**
- **-40°C to +85°C Operating Temperature Range**
- **Available in Green SOT-23-5 and SC70-5 Packages**

APPLICATIONS

RC Timers
Window Detectors
IR Receiver
Multivibrators
Alarm and Monitoring Circuits

ELECTRICAL CHARACTERISTICS(At $T_A = +25^\circ\text{C}$, $+V_S = 1.4\text{V}$, $-V_S = 0\text{V}$, $V_{CM} = +V_S/2$ and $V_{OUT} = -V_S$, unless otherwise noted.)

PARAMETER	SYMBOL	CONDITIONS	MIN	TYP	MAX	UNITS
Supply Current	I_S	$V_{CM} = 0.3\text{V}$		300	1000	nA
		$V_{CM} = 1.1\text{V}$		250	1000	
Input Offset Voltage	V_{OS}	$V_{CM} = 0\text{V}$	-3	0.5	3	mV
		$V_{CM} = 1.4\text{V}$	-3	0.5	3	
Input Offset Average Drift				2		$\mu\text{V}/^\circ\text{C}$
Common Mode Rejection Ratio	CMRR	V_{CM} Stepped from 0V to 0.3V		65		dB
		V_{CM} Stepped from 0.8V to 1.4V		75		
		V_{CM} Stepped from 0V to 1.4V		75		
Power Supply Rejection Ratio	PSRR	$V_S = 1.8\text{V}$ to 5.5V , $V_{CM} = 0\text{V}$	66	95		dB
Large Signal Voltage Gain	A_{VO}			100		dB
Output Swing High	V_{OH}	$V_S = 1.8\text{V}$, $I_{OUT} = 500\mu\text{A}$	1.598	1.669		V
		$-40^\circ\text{C} \leq T_A \leq +85^\circ\text{C}$	1.581			
		$V_S = 1.8\text{V}$, $I_{OUT} = 1\text{mA}$	1.324	1.508		
		$-40^\circ\text{C} \leq T_A \leq +85^\circ\text{C}$	1.288			
Output Swing Low	V_{OL}	$V_S = 1.8\text{V}$, $I_{OUT} = -500\mu\text{A}$		82	112	mV
		$-40^\circ\text{C} \leq T_A \leq +85^\circ\text{C}$			127	
		$V_S = 1.8\text{V}$, $I_{OUT} = -1\text{mA}$		167	225	
		$-40^\circ\text{C} \leq T_A \leq +85^\circ\text{C}$			253	
Output Current	I_{OUT}	Source		0.7		mA
		Sink		2.0		
Propagation Delay (High to Low)		Overdrive = 10mV		12		μs
		Overdrive = 100mV		6		
Propagation Delay (Low to High)		Overdrive = 10mV		26		μs
		Overdrive = 100mV		17		
Rise Time	t_{Rise}	Overdrive = 10mV, $C_L = 30\text{pF}$, $R_L = 1\text{M}\Omega$		220		ns
		Overdrive = 100mV, $C_L = 30\text{pF}$, $R_L = 1\text{M}\Omega$		220		
Fall Time	t_{Fall}	Overdrive = 10mV, $C_L = 30\text{pF}$, $R_L = 1\text{M}\Omega$		155		ns
		Overdrive = 100mV, $C_L = 30\text{pF}$, $R_L = 1\text{M}\Omega$		155		

ELECTRICAL CHARACTERISTICS (continued)(At $T_A = +25^\circ\text{C}$, $+V_S = 2.5\text{V}$, $-V_S = 0\text{V}$, $V_{CM} = +V_S/2$ and $V_{OUT} = -V_S$, unless otherwise noted.)

PARAMETER	SYMBOL	CONDITIONS	MIN	TYP	MAX	UNITS
Supply Current	I_S	$V_{CM} = 0.3\text{V}$		310		nA
		$V_{CM} = 2.2\text{V}$		260		
Input Offset Voltage	V_{OS}	$V_{CM} = 0\text{V}$		0.5		mV
		$V_{CM} = 2.5\text{V}$		0.5		
Input Offset Average Drift				2		$\mu\text{V}/^\circ\text{C}$
Common Mode Rejection Ratio	CMRR	V_{CM} Stepped from 0V to 1.4V		75		dB
		V_{CM} Stepped from 1.9V to 2.5V		80		
		V_{CM} Stepped from 0V to 2.5V		80		
Power Supply Rejection Ratio	PSRR	$V_S = 1.8\text{V}$ to 5.5V , $V_{CM} = 0\text{V}$		95		dB
Large Signal Voltage Gain	A_{VO}			100		dB
Output Swing High	V_{OH}	$I_{OUT} = 500\mu\text{A}$		2.419		V
		$I_{OUT} = 1\text{mA}$		2.333		
Output Swing Low	V_{OL}	$I_{OUT} = -500\mu\text{A}$		66		mV
		$I_{OUT} = -1\text{mA}$		133		
Output Current	I_{OUT}	Source		5.3		mA
		Sink		7.7		
Propagation Delay (High to Low)		Overdrive = 10mV		12		μs
		Overdrive = 100mV		5		
Propagation Delay (Low to High)		Overdrive = 10mV		28		μs
		Overdrive = 100mV		19		
Rise Time	t_{Rise}	Overdrive = 10mV, $C_L = 30\text{pF}$, $R_L = 1\text{M}\Omega$		120		ns
		Overdrive = 100mV, $C_L = 30\text{pF}$, $R_L = 1\text{M}\Omega$		120		
Fall Time	t_{Fall}	Overdrive = 10mV, $C_L = 30\text{pF}$, $R_L = 1\text{M}\Omega$		85		ns
		Overdrive = 100mV, $C_L = 30\text{pF}$, $R_L = 1\text{M}\Omega$		70		

ELECTRICAL CHARACTERISTICS (continued)(At $T_A = +25^\circ\text{C}$, $+V_S = 5.0\text{V}$, $-V_S = 0\text{V}$, $V_{CM} = +V_S/2$ and $V_{OUT} = -V_S$, unless otherwise noted.)

PARAMETER	SYMBOL	CONDITIONS	MIN	TYP	MAX	UNITS
Supply Current	I_S	$V_{CM} = 0.3\text{V}$		350	2000	nA
		$V_{CM} = 4.7\text{V}$		300	2000	
Input Offset Voltage	V_{OS}	$V_{CM} = 0\text{V}$	-3	0.5	3	mV
		$V_{CM} = 5\text{V}$	-3	0.5	3	
Input Offset Average Drift				2		$\mu\text{V}/^\circ\text{C}$
Common Mode Rejection Ratio	CMRR	V_{CM} Stepped from 0V to 3.9V		85		dB
		V_{CM} Stepped from 4.4V to 5.0V		85		
		V_{CM} Stepped from 0V to 5.0V		85		
Power Supply Rejection Ratio	PSRR	$V_S = 1.8\text{V}$ to 5.5V , $V_{CM} = 0\text{V}$	66	95		dB
Large Signal Voltage Gain	A_{VO}			105		dB
Output Swing High	V_{OH}	$I_{OUT} = 500\mu\text{A}$	4.923	4.952		V
		$-40^\circ\text{C} \leq T_A \leq +85^\circ\text{C}$	4.916			
		$I_{OUT} = 1\text{mA}$	4.864	4.904		
		$-40^\circ\text{C} \leq T_A \leq +85^\circ\text{C}$	4.848			
Output Swing Low	V_{OL}	$I_{OUT} = -500\mu\text{A}$		52	80	mV
		$-40^\circ\text{C} \leq T_A \leq +85^\circ\text{C}$			90	
		$I_{OUT} = -1\text{mA}$		104	130	
		$-40^\circ\text{C} \leq T_A \leq +85^\circ\text{C}$			143	
Output Current	I_{OUT}	Source	14	18		mA
		$-40^\circ\text{C} \leq T_A \leq +85^\circ\text{C}$	12.1			
		Sink	15	19		
		$-40^\circ\text{C} \leq T_A \leq +85^\circ\text{C}$	12.9			
Propagation Delay (High to Low)		Overdrive = 10mV		13		μs
		Overdrive = 100mV		6		
Propagation Delay (Low to High)		Overdrive = 10mV		42		μs
		Overdrive = 100mV		33		
Rise Time	t_{Rise}	Overdrive = 10mV, $C_L = 30\text{pF}$, $R_L = 1\text{M}\Omega$		85		ns
		Overdrive = 100mV, $C_L = 30\text{pF}$, $R_L = 1\text{M}\Omega$		85		
Fall Time	t_{Fall}	Overdrive = 10mV, $C_L = 30\text{pF}$, $R_L = 1\text{M}\Omega$		70		ns
		Overdrive = 100mV, $C_L = 30\text{pF}$, $R_L = 1\text{M}\Omega$		60		

SIMPLIFIED SCHEMATIC DIAGRAM

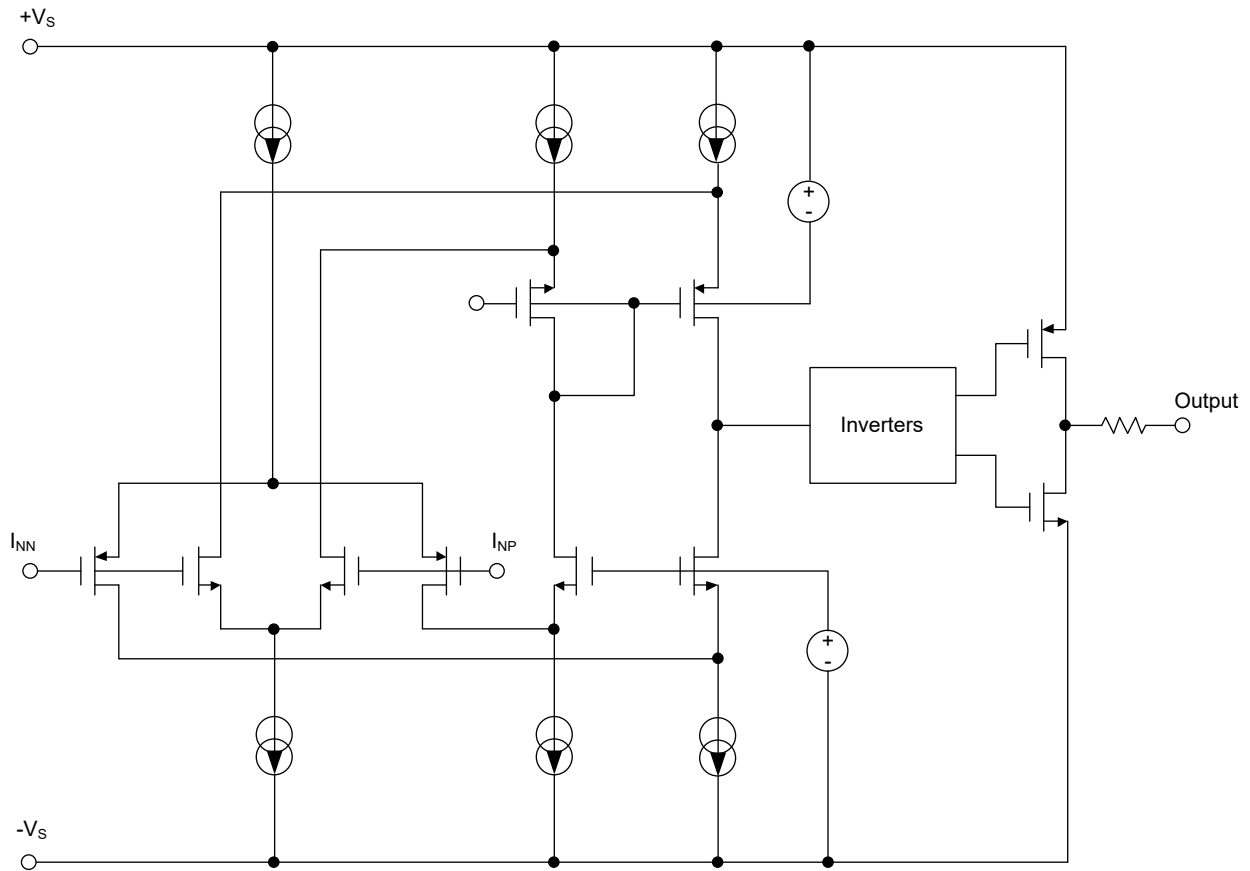

TYPICAL PERFORMANCE CHARACTERISTICS

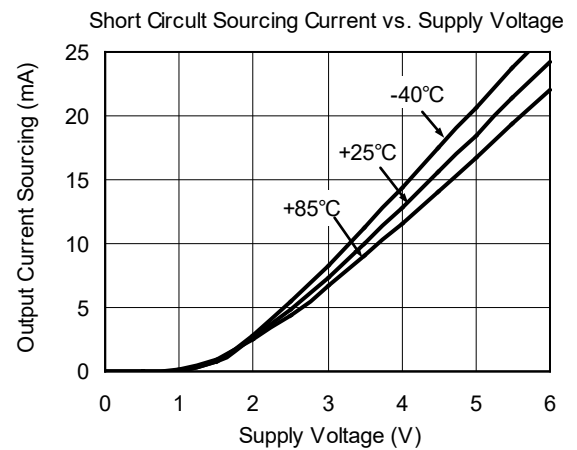
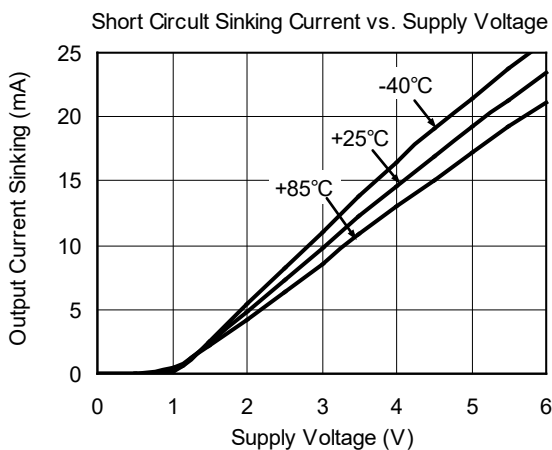
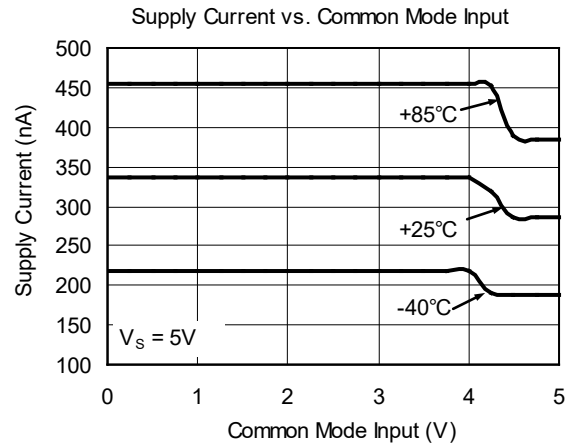
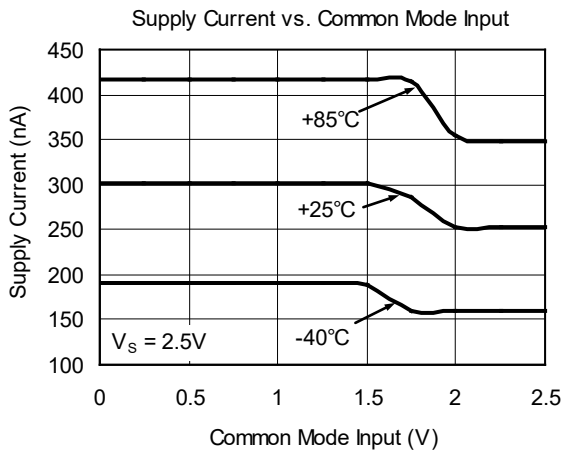
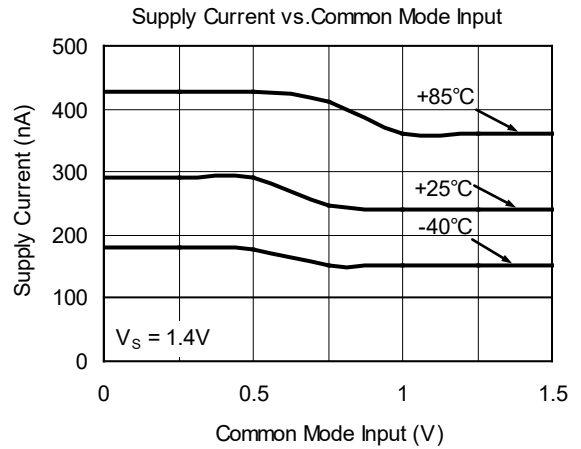
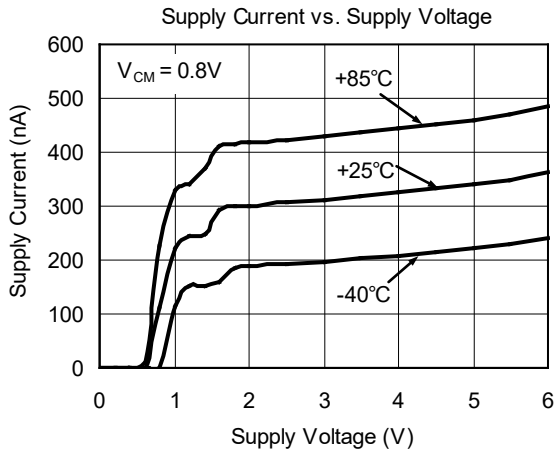

TYPICAL PERFORMANCE CHARACTERISTICS (continued)

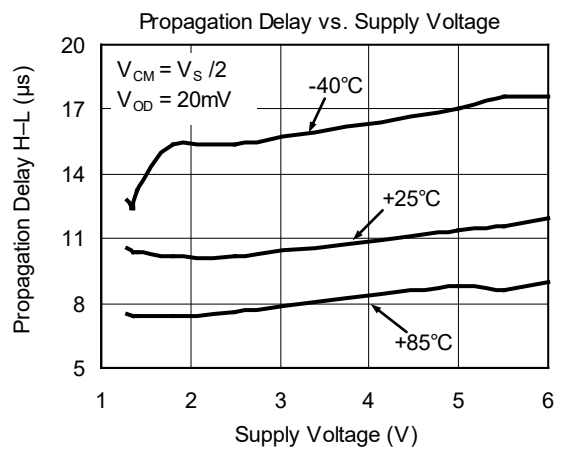
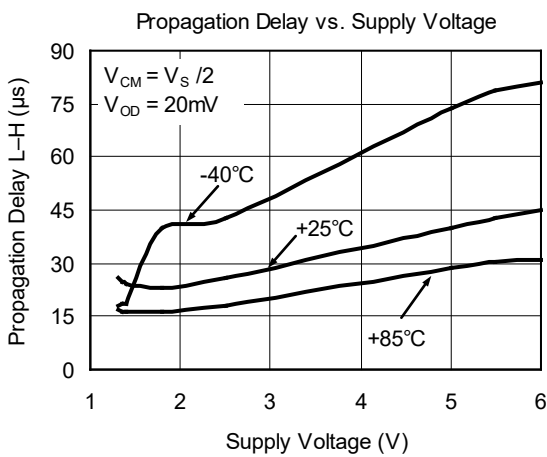
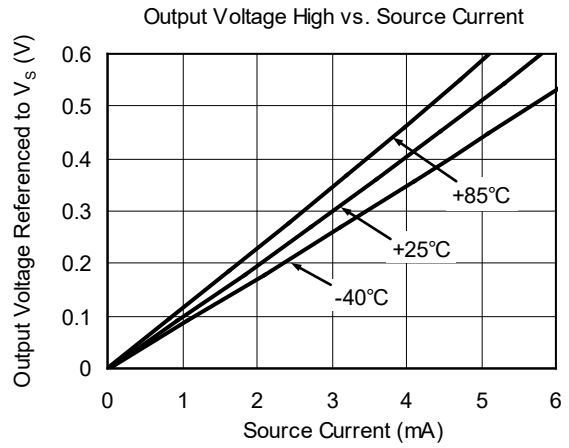
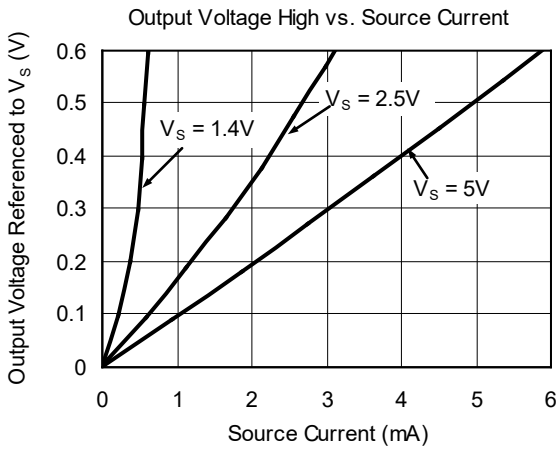
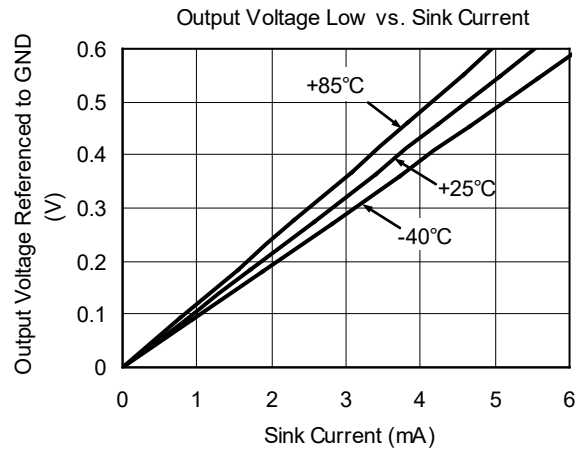
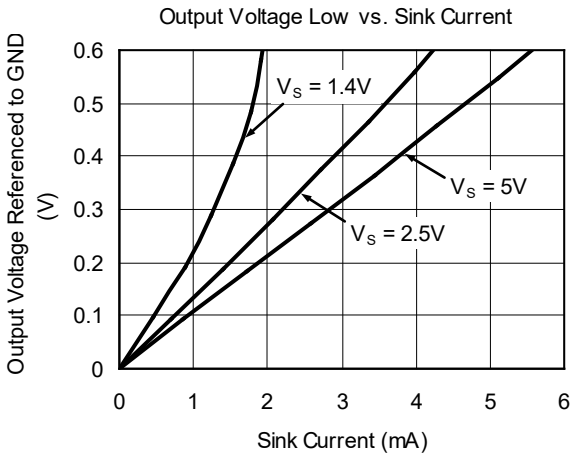

TYPICAL PERFORMANCE CHARACTERISTICS (continued)

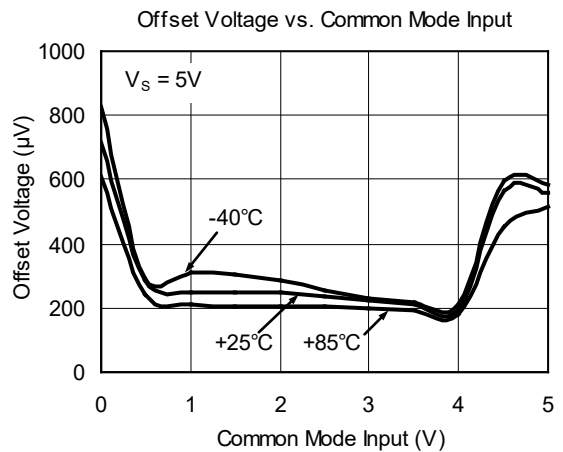
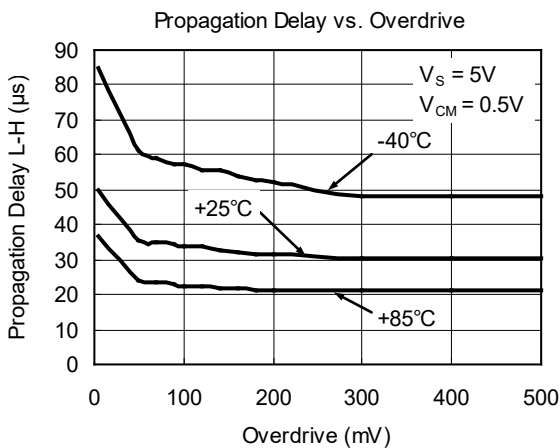
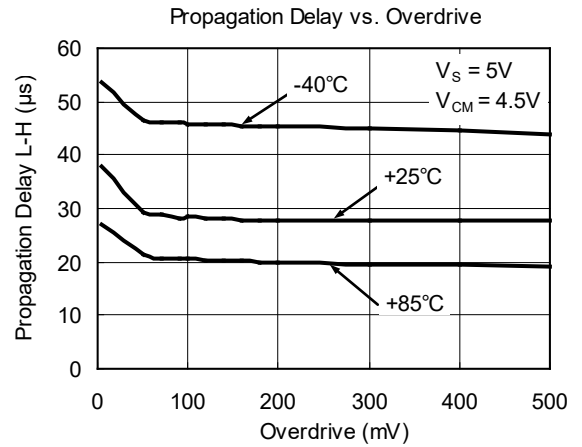
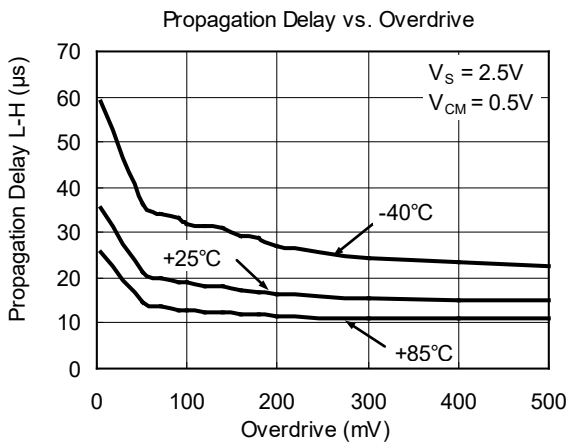
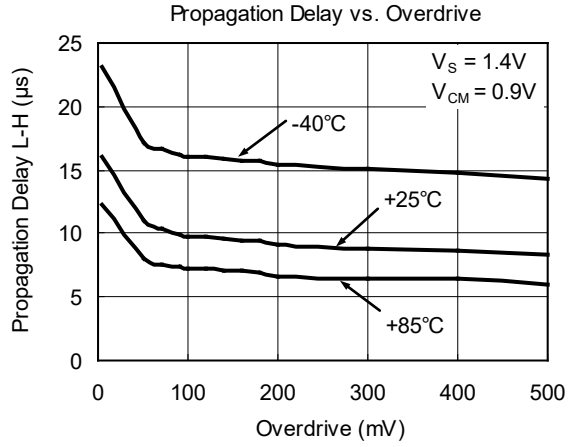
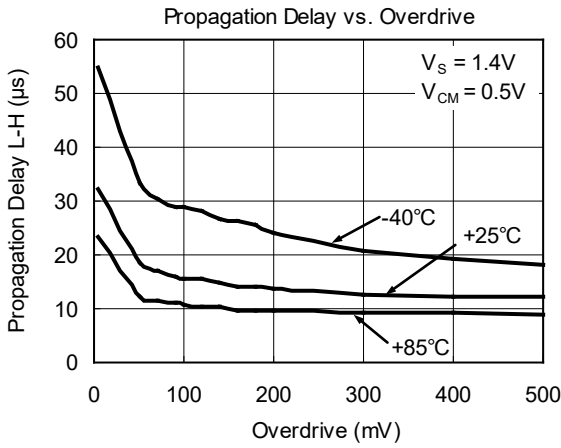

TYPICAL PERFORMANCE CHARACTERISTICS (continued)

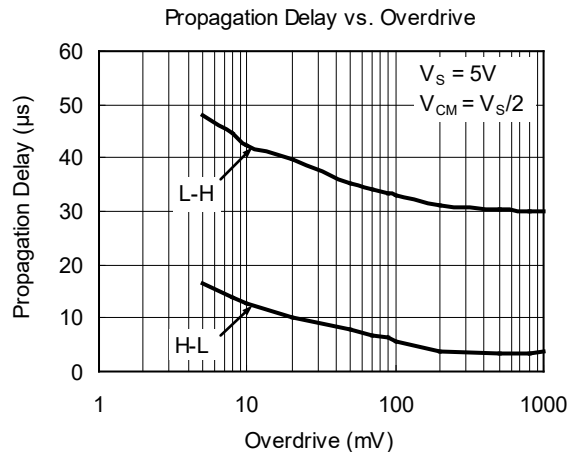
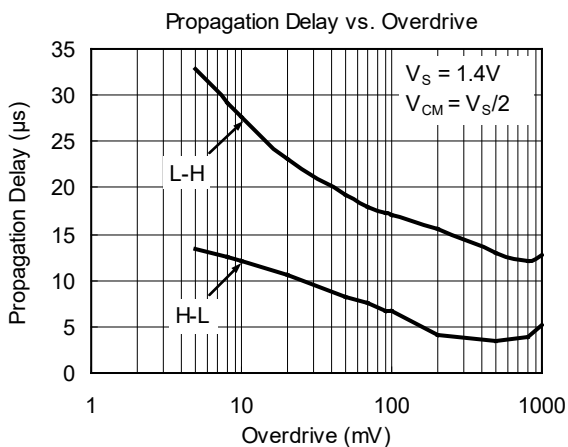
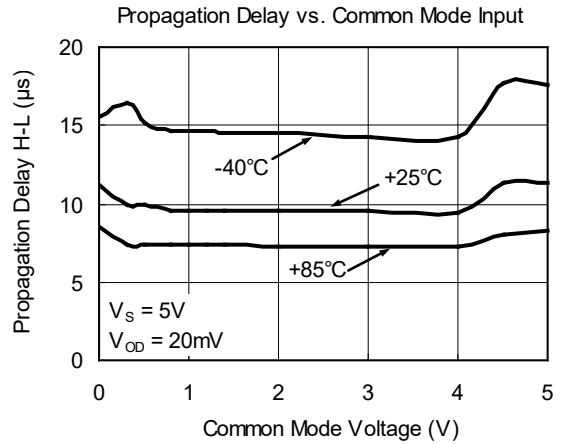
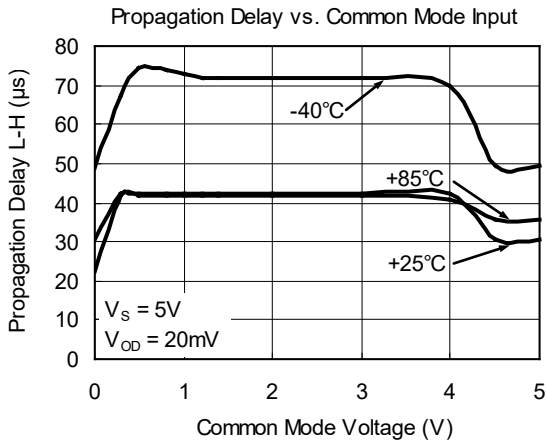
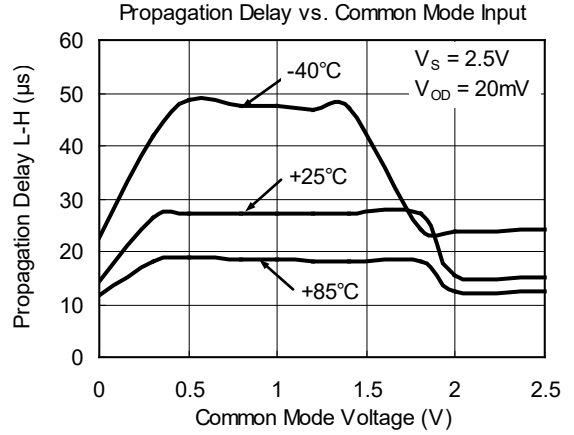
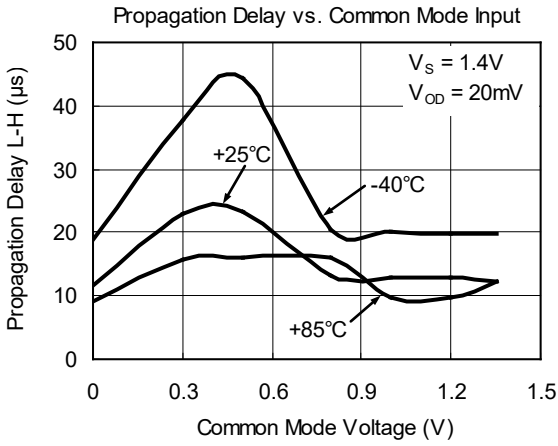

TYPICAL PERFORMANCE CHARACTERISTICS (continued)

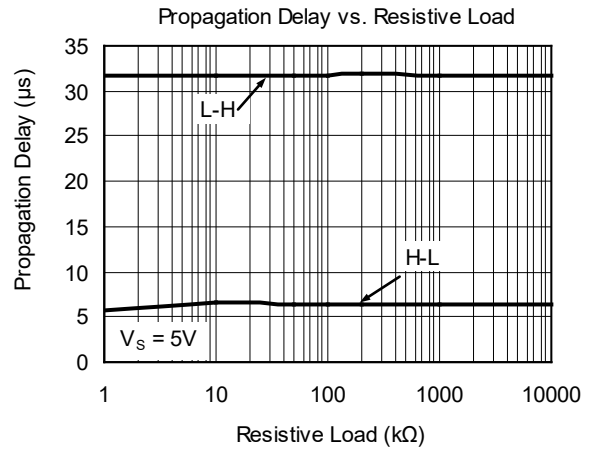
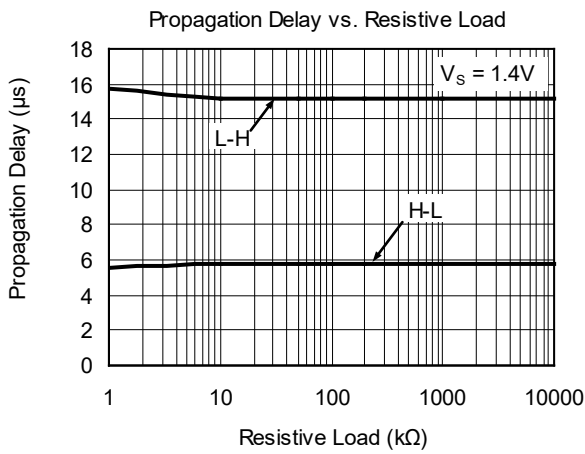

REVISION HISTORY

NOTE: Page numbers for previous revisions may differ from page numbers in the current version.

NOVEMBER 2013 – REV.A.1 to REV.A.2	Page
Changed Electrical Characteristics section	4
JANUARY 2013 – REV.A to REV.A.1	Page
Added Tape and Reel Information section	14, 15
Changes from Original (DECEMBER 2011) to REV.A	Page
Changed from product preview to production data	All

PACKAGE INFORMATION

PACKAGE OUTLINE DIMENSIONS

SOT-23-5

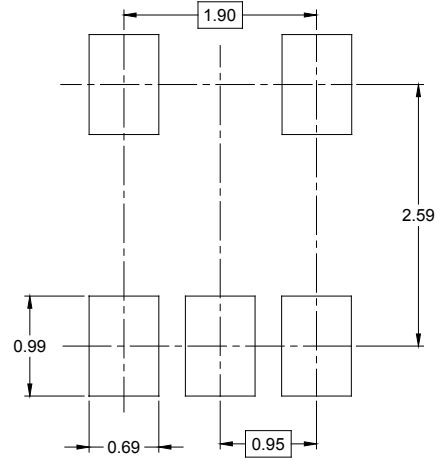

RECOMMENDED LAND PATTERN (Unit: mm)



Symbol	Dimensions In Millimeters		Dimensions In Inches	
	MIN	MAX	MIN	MAX
A	1.050	1.250	0.041	0.049
A1	0.000	0.100	0.000	0.004
A2	1.050	1.150	0.041	0.045
b	0.300	0.500	0.012	0.020
c	0.100	0.200	0.004	0.008
D	2.820	3.020	0.111	0.119
E	1.500	1.700	0.059	0.067
E1	2.650	2.950	0.104	0.116
e	0.950 BSC		0.037 BSC	
e1	1.900 BSC		0.075 BSC	
L	0.300	0.600	0.012	0.024
θ	0°	8°	0°	8°

PACKAGE OUTLINE DIMENSIONS

SC70-5

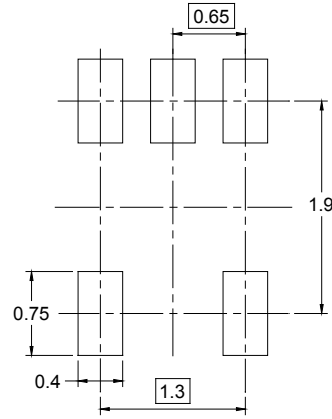
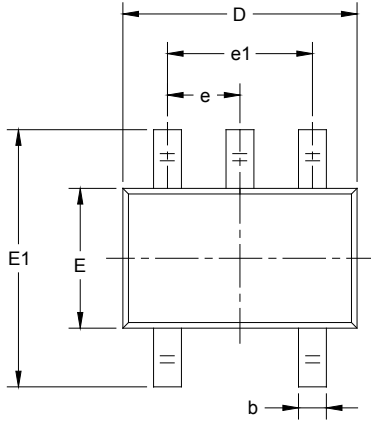

RECOMMENDED LAND PATTERN (Unit: mm)

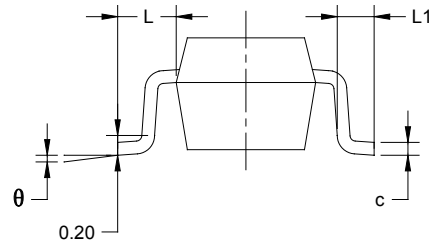
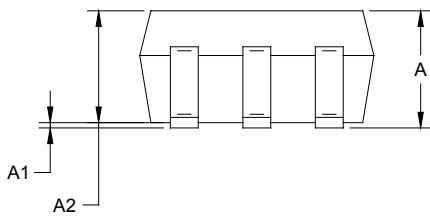

Symbol	Dimensions In Millimeters		Dimensions In Inches	
	MIN	MAX	MIN	MAX
A	0.900	1.100	0.035	0.043
A1	0.000	0.100	0.000	0.004
A2	0.900	1.000	0.035	0.039
b	0.150	0.350	0.006	0.014
c	0.080	0.150	0.003	0.006
D	2.000	2.200	0.079	0.087
E	1.150	1.350	0.045	0.053
E1	2.150	2.450	0.085	0.096
e	0.65 TYP		0.026 TYP	
e1	1.300 BSC		0.051 BSC	
L	0.525 REF		0.021 REF	
L1	0.260	0.460	0.010	0.018
θ	0°	8°	0°	8°

TAPE AND REEL INFORMATION

REEL DIMENSIONS



TAPE DIMENSIONS



NOTE: The picture is only for reference. Please make the object as the standard.

KEY PARAMETER LIST OF TAPE AND REEL

Package Type	Reel Diameter	Reel Width W1 (mm)	A0 (mm)	B0 (mm)	K0 (mm)	P0 (mm)	P1 (mm)	P2 (mm)	W (mm)	Pin1 Quadrant
SOT-23-5	7"	9.5	3.20	3.20	1.40	4.0	4.0	2.0	8.0	Q3
SC70-5	7"	9.5	2.25	2.55	1.20	4.0	4.0	2.0	8.0	Q3

D00001

PACKAGE INFORMATION

CARTON BOX DIMENSIONS



NOTE: The picture is only for reference. Please make the object as the standard.

KEY PARAMETER LIST OF CARTON BOX

Reel Type	Length (mm)	Width (mm)	Height (mm)	Pizza/Carton
7" (Option)	368	227	224	8
7"	442	410	224	18

DD0002