

### Features

- **Gain-bandwidth Product: 10 MHz**
- **Low Noise: 8.2 nV/ $\sqrt{\text{Hz}}$ (f= 1kHz)**
- **Slew Rate: 7 V/ $\mu\text{s}$**
- **Offset Voltage: 1 mV (max)**
- **EMIRR IN+: 88 dB( under 2.4GHz)**
- **Low THD+N: 0.0005%**
- **Supply Range: 2.2 V to 5.5 V**
- **Supply Current: 1.4 mA/ch**
- **Low Input Bias Current: 0.3pA Typical**
- **Rail-to-Rail I/O**
- **High Output Current: 70 mA (1.0V Drop)**
- **-40°C to 125°C Operation Range**

### Applications

- Sensor Signal Conditioning
- Consumer Audio
- Multi-Pole Active Filters
- Control-Loop Amplifiers
- Communications
- Security
- Scanners

### Description

The TP2411, TP2412, and TP2414 are low cost, single, dual, and quad rail-to-rail output, single-supply amplifiers featuring low offset and input voltages, low current noise, and wide signal bandwidth. The combination of low offset, low noise, very low input bias currents, and high speed make these amplifiers useful in a wide variety of applications. Filters, integrators, photodiode amplifiers, and high impedance sensors all benefit from this combination of performance features. Audio and other ac applications benefit from the wide bandwidth and low distortion of these devices.

Applications for these amplifiers include power amplifier (PA) controls, laser diode control loops, portable and loop-powered instrumentation, audio amplification for portable devices, and ASIC input and output amplifiers.

The TP2411 is single channel version available in 8-pin SOP and 5-pin SOT23 packages. The TP2412 is dual channel version available in 8-pin SOP, SOT, TSSOP and MSOP packages. The TP2414 is quad channel version available in 14-pin SOP and TSSOP packages.

3PEAK and the 3PEAK logo are registered trademarks of 3PEAK INCORPORATED. All other trademarks are the property of their respective owners.

### Pin Configuration (Top View)

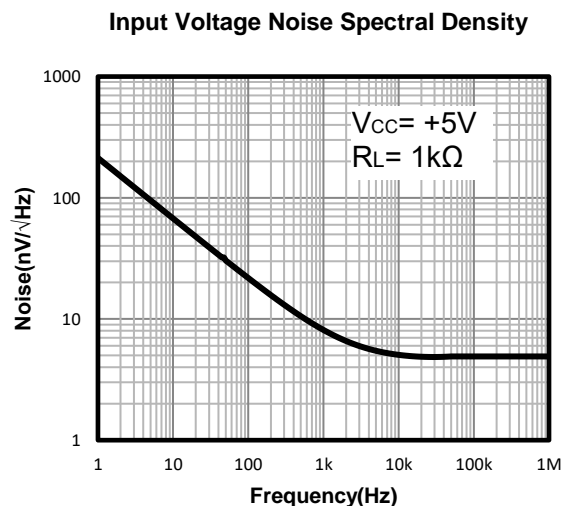
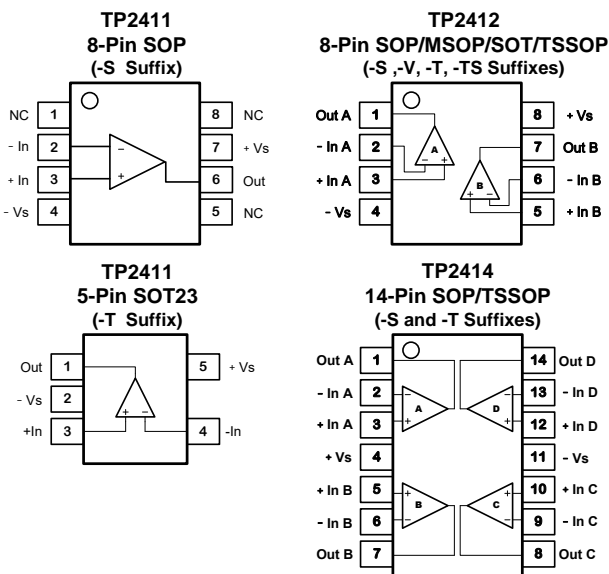

# TP2411 / TP2412 / TP2414

## Low Cost, Low Noise CMOS RRIO Op-amps

### Order Information

Model Name	Order Number	Package	Transport Media, Quantity	Marking Information
TP2411	TP2411-TR	5-Pin SOT23	Tape and Reel, 3,000	411
TP2412	TP2412-SR	8-Pin SOP	Tape and Reel, 4,000	TP2412
	TP2412-VR	8-Pin MSOP	Tape and Reel, 3,000	TP2412
	TP2412-TSR	8-Pin TSSOP	Tape and Reel, 3,000	TP2412
	TP2412-TR	8-Pin SOT23	Tape and Reel, 3,000	S12
TP2414	TP2414-SR	14-Pin SOP	Tape and Reel, 2,500	TP2414
	TP2414-TR	14-Pin TSSOP	Tape and Reel, 3,000	TP2414

### Absolute Maximum Ratings <sup>Note 1</sup>

Supply Voltage:  $V^+ - V^-$  <sup>Note 2</sup> ..... 7.0V  
 Input Voltage.....  $V^- - 0.3$  to  $V^+ + 0.3$   
 Input Current: +IN, -IN <sup>Note 3</sup> .....  $\pm 20$ mA  
 Output Short-Circuit Duration <sup>Note 4</sup> ..... Indefinite  
 Current at Supply Pins .....  $\pm 60$ mA

Operating Temperature Range.....  $-40^\circ\text{C}$  to  $125^\circ\text{C}$   
 Maximum Junction Temperature.....  $150^\circ\text{C}$   
 Storage Temperature Range.....  $-65^\circ\text{C}$  to  $150^\circ\text{C}$   
 Lead Temperature (Soldering, 10 sec) .....  $260^\circ\text{C}$

**Note 1:** Stresses beyond those listed under Absolute Maximum Ratings may cause permanent damage to the device. Exposure to any Absolute Maximum Rating condition for extended periods may affect device reliability and lifetime.

**Note 2:** The op amp supplies must be established simultaneously, with, or before, the application of any input signals.

**Note 3:** The inputs are protected by ESD protection diodes to each power supply. If the input extends more than 500mV beyond the power supply, the input current should be limited to less than 10mA.

**Note 4:** A heat sink may be required to keep the junction temperature below the absolute maximum. This depends on the power supply voltage and how many amplifiers are shorted. Thermal resistance varies with the amount of PC board metal connected to the package. The specified values are for short traces connected to the leads.

### ESD, Electrostatic Discharge Protection

Symbol	Parameter	Condition	Minimum Level	Unit
HBM	Human Body Model ESD	ANSI/ESDA/JEDEC JS-001	4	kV
CDM	Charged Device Model ESD	ANSI/ESDA/JEDEC JS-002	1	kV

### Thermal Resistance

Package Type	$\theta_{JA}$	$\theta_{JC}$	Unit
5-Pin SOT23	250	81	$^\circ\text{C/W}$
8-Pin SOP	158	43	$^\circ\text{C/W}$
8-Pin MSOP	210	45	$^\circ\text{C/W}$
8-Pin TSSOP	191		$^\circ\text{C/W}$
8-Pin SOT23	196	70	$^\circ\text{C/W}$
14-Pin SOP	120	36	$^\circ\text{C/W}$
14-Pin TSSOP	180	35	$^\circ\text{C/W}$

### Electrical Characteristics

Low Cost, Low Noise CMOS RRIO Op-amps

The specifications are at  $T_A = 27^\circ\text{C}$ .  $V_S = 5\text{V}$ ,  $R_L = 2\text{k}\Omega$ ,  $C_L = 100\text{pF}$ . Unless otherwise noted.

SYMBOL	PARAMETER	CONDITIONS	MIN	TYP	MAX	UNITS
V <sub>OS</sub>	Input Offset Voltage	V <sub>CM</sub> = V <sub>S</sub> /2	-1	±0.25	+1	mV
		V <sub>CM</sub> = 0V	-1	±0.25	+1	mV
V <sub>OS TC</sub>	Input Offset Voltage Drift	-40°C to 125°C		1		µV/°C
I <sub>B</sub>	Input Bias Current	T <sub>A</sub> = 27 °C		0.3		pA
		T <sub>A</sub> = 85 °C		150		pA
		T <sub>A</sub> = 125 °C		300		pA
I <sub>OS</sub>	Input Offset Current			0.3		pA
V <sub>n</sub>	Input Voltage Noise	f = 0.1Hz to 10Hz		3.14		µV <sub>PP</sub>
e <sub>n</sub>	Input Voltage Noise Density	f = 1kHz		8.2		nV/√Hz
i <sub>n</sub>	Input Current Noise	f = 1kHz		2		fA/√Hz
C <sub>IN</sub>	Input Capacitance	Differential		8		pF
		Common Mode		7		
CMRR	Common Mode Rejection Ratio	V <sub>CM</sub> = 2.5V	90	106		dB
		V <sub>CM</sub> = 0V to 3V	80	106		dB
		V <sub>CM</sub> = 0V to 5V	55	72		dB
V <sub>CM</sub>	Common-mode Input Voltage Range		V- -0.1		V+ +0.1	V
PSRR	Power Supply Rejection Ratio	V <sub>S</sub> = 2.2V to 5.5V, V <sub>CM</sub> = 0V	82	100		dB
A <sub>VOL</sub>	Open-Loop Large Signal Gain	R <sub>LOAD</sub> = 2kΩ, V <sub>OUT</sub> = -2V to 2V	100	120		dB
V <sub>OL</sub> , V <sub>OH</sub>	Output Swing from Supply Rail	R <sub>LOAD</sub> = 2kΩ		20	50	mV
R <sub>OUT</sub>	Closed-Loop Output Impedance	G = 1, f = 1MHz, I <sub>OUT</sub> = 0		0.2		Ω
R <sub>O</sub>	Open-Loop Output Impedance	f = 1kHz, I <sub>OUT</sub> = 0		125		Ω
I <sub>SC</sub>	Output Short-Circuit Current	Sink or source current	100	130		mA
V <sub>S</sub>	Supply Voltage		2.2		5.5	V
I <sub>Q</sub>	Quiescent Current per Amplifier	V <sub>S</sub> = 5V		1.4	1.95	mA
PM	Phase Margin	R <sub>LOAD</sub> = 1kΩ, C <sub>LOAD</sub> = 60pF		60		°
GM	Gain Margin	R <sub>LOAD</sub> = 1kΩ, C <sub>LOAD</sub> = 60pF		8		dB
GBWP	Gain-Bandwidth Product	f = 1kHz		10		MHz
SR	Slew Rate	A <sub>V</sub> = 1, V <sub>OUT</sub> = 0V to 10V, C <sub>LOAD</sub> = 100pF, R <sub>LOAD</sub> = 2kΩ	3.0	7		V/µs
FPBW	Full Power Bandwidth <sup>Note 1</sup>			414		kHz
t <sub>s</sub>	Settling Time, 0.1% Settling Time, 0.01%	A <sub>V</sub> = -1, 1V Step		0.75		µs
				0.85		
THD+N	Total Harmonic Distortion and Noise	f = 1kHz, A <sub>V</sub> = 1, R <sub>L</sub> = 2kΩ, V <sub>OUT</sub> = 1V <sub>p-p</sub>		0.0005		%
X <sub>talk</sub>	Channel Separation	f = 1kHz, R <sub>L</sub> = 2kΩ		110		dB

**Note 1:** Full power bandwidth is calculated from the slew rate  $FPBW = SR/\pi \cdot V_{P-P}$

# TP2411 / TP2412 / TP2414

## Low Cost, Low Noise CMOS RRIO Op-amps Typical Performance Characteristics

$V_S = \pm 2.75V$ ,  $V_{CM} = 0V$ ,  $R_L = \text{Open}$ , unless otherwise specified.

### Offset Voltage Production Distribution

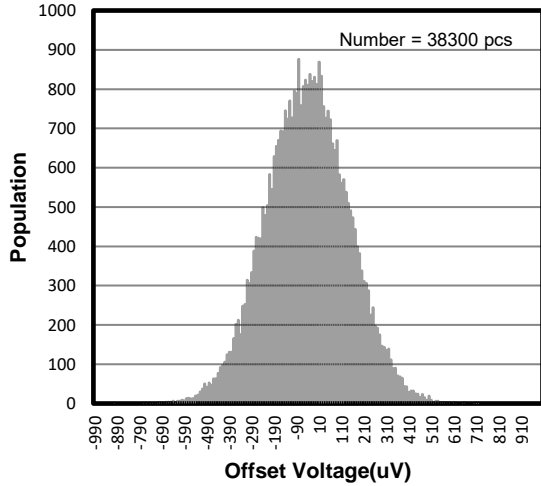

### Unity Gain Bandwidth vs. Temperature

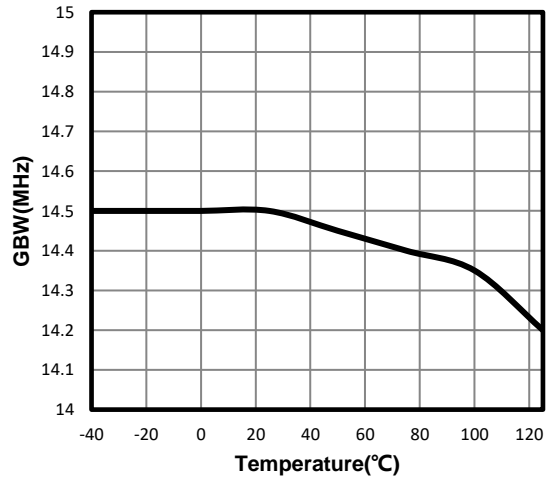

### Open-Loop Gain and Phase

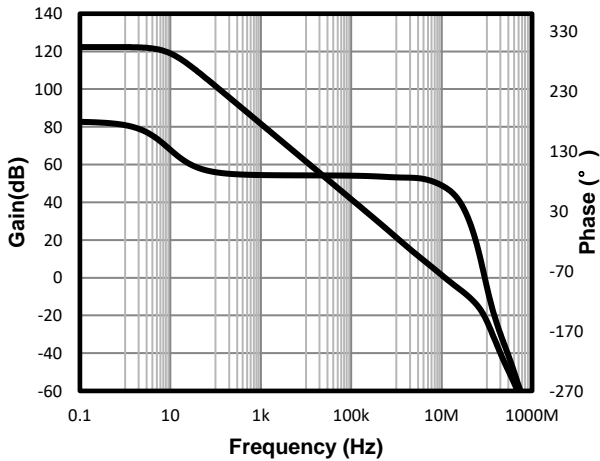

### Input Voltage Noise Spectral Density

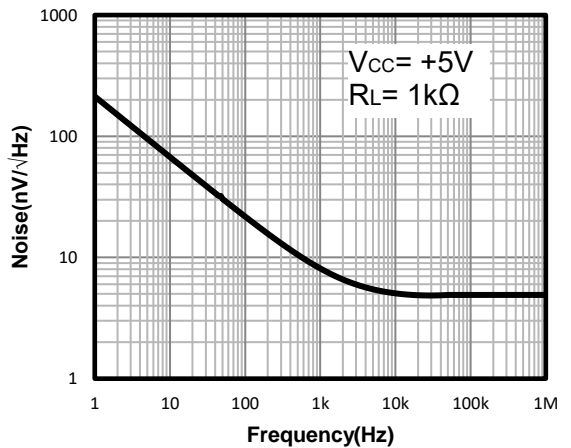

### Input Bias Current vs. Temperature

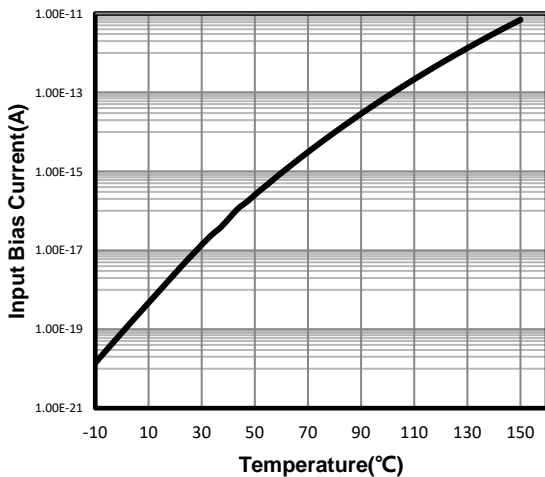

### Input Bias Current vs. Input Common Mode Voltage

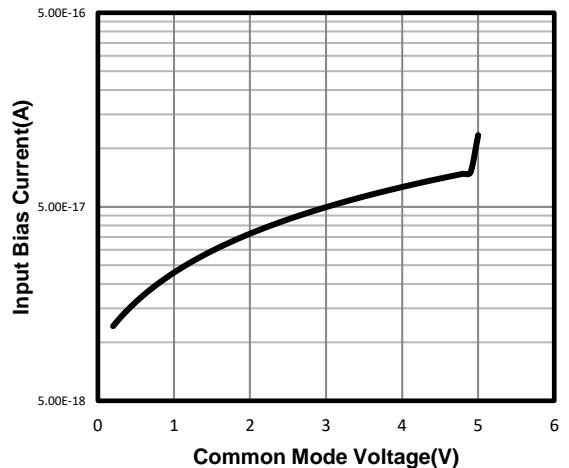

Typical Performance Characteristics

$V_s = \pm 2.75V$ ,  $V_{CM} = 0V$ ,  $R_L = \text{Open}$ , unless otherwise specified. (Continued)

Common Mode Rejection Ratio

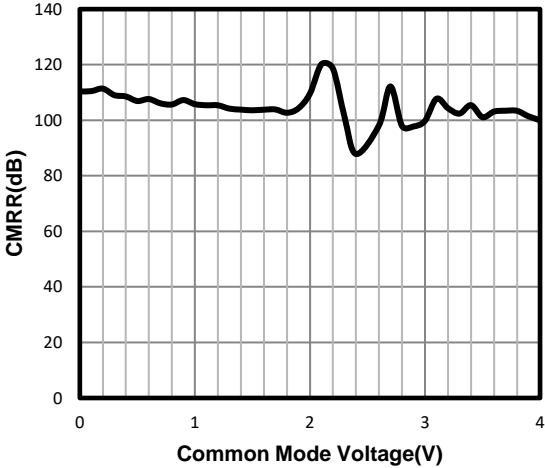

CMRR vs. Frequency

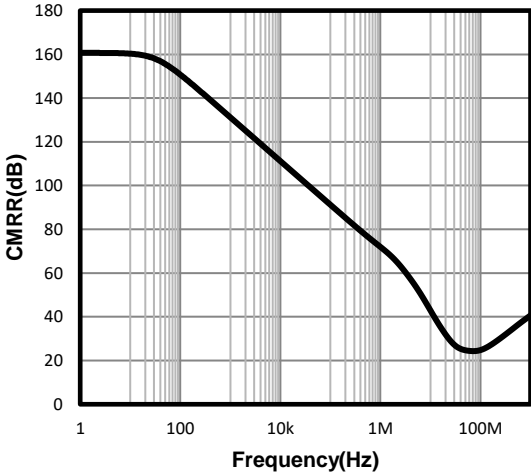

Quiescent Current vs. Temperature

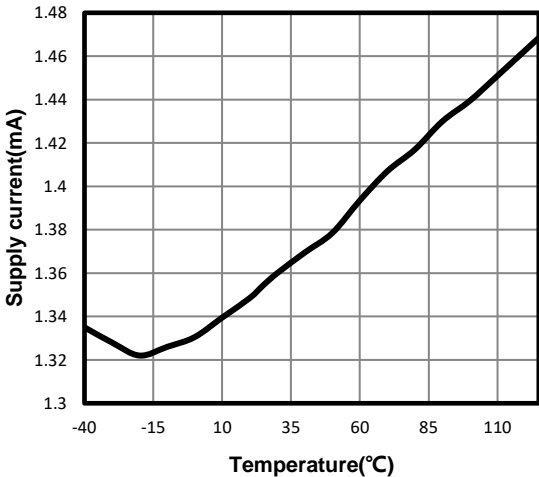

Short Circuit Current vs. Temperature

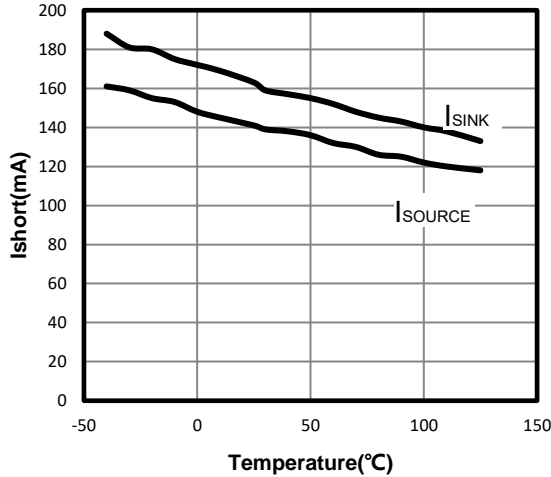

Power-Supply Rejection Ratio

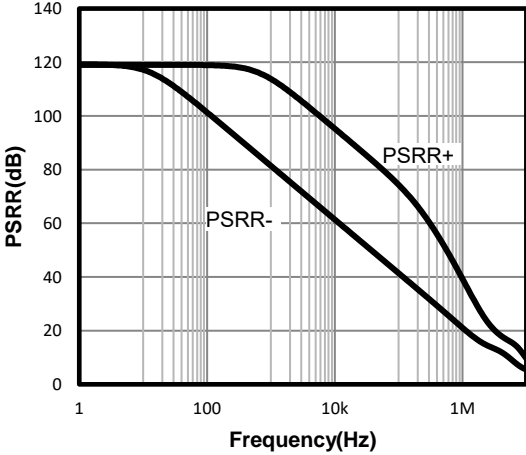

Quiescent Current vs. Supply Voltage

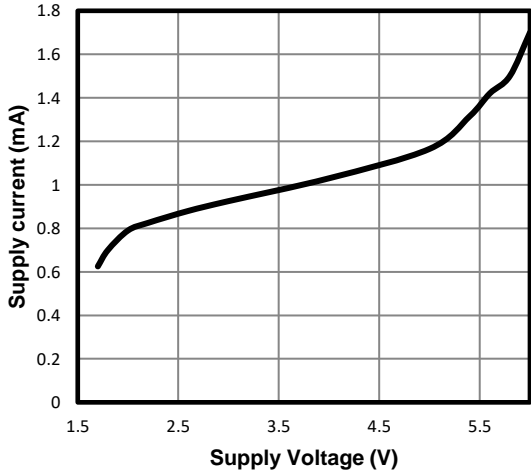

# TP2411 / TP2412 / TP2414

## Low Cost, Low Noise CMOS RRIO Op-amps Typical Performance Characteristics

$V_S = \pm 2.75V$ ,  $V_{CM} = 0V$ ,  $R_L = \text{Open}$ , unless otherwise specified. (Continued)

### Power-Supply Rejection Ratio vs. Temperature

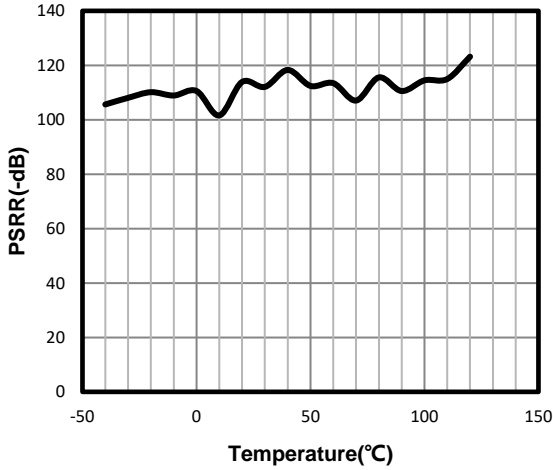

### CMRR vs. Temperature

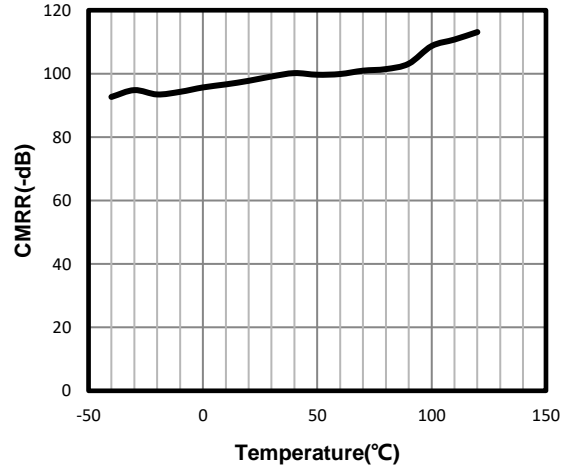

### EMIRR IN+ vs. Frequency

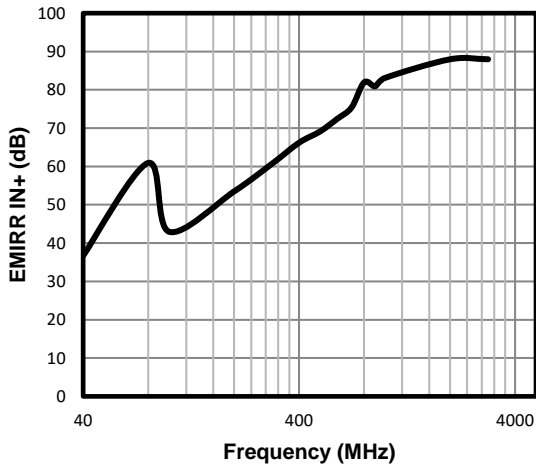

### Large-Scale Step Response

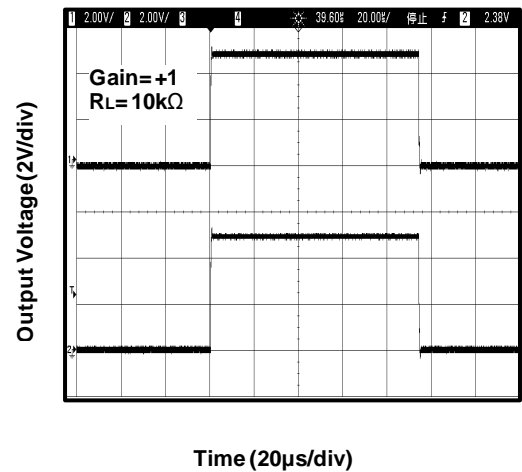

### Negative Over-Voltage Recovery

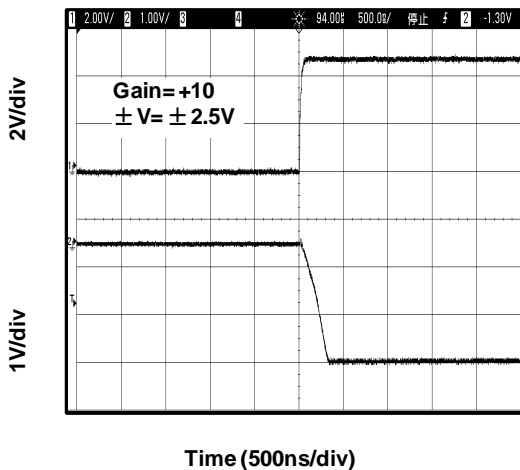

### Positive Over-Voltage Recovery

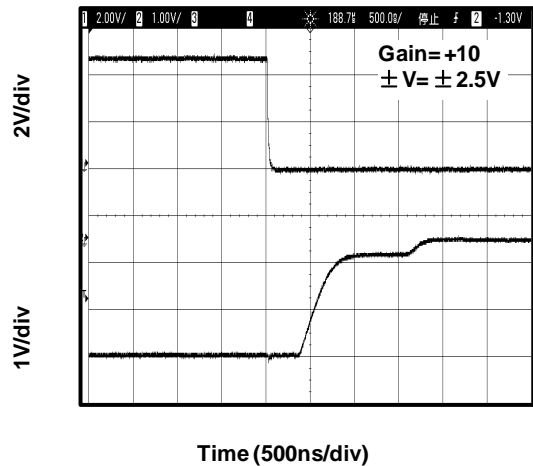

Typical Performance Characteristics

V<sub>s</sub> = ±2.75V, V<sub>CM</sub> = 0V, R<sub>L</sub> = Open, unless otherwise specified. (Continued)

0.1 Hz TO 10 Hz Input Voltage Noise

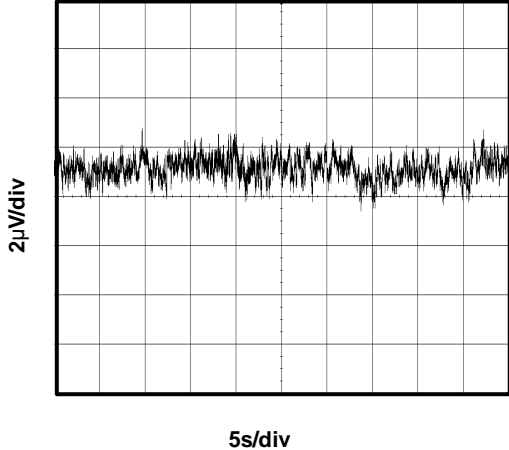

Offset Voltage vs Common-Mode Voltage

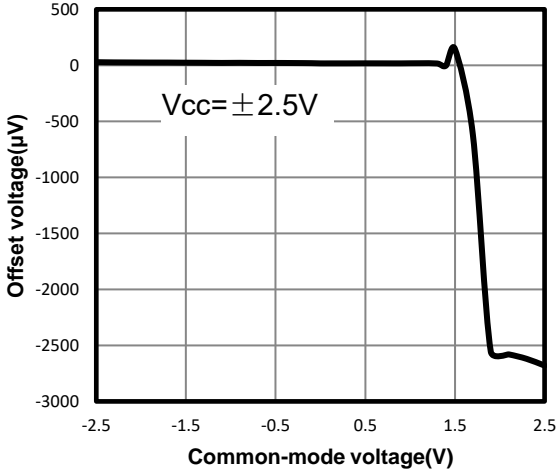

Positive Output Swing vs. Load Current

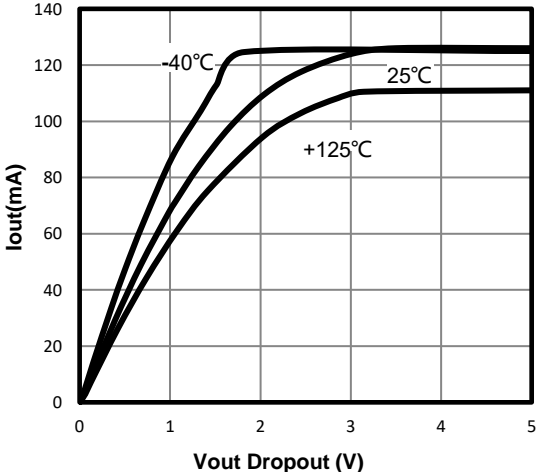

Negative Output Swing vs. Load Current

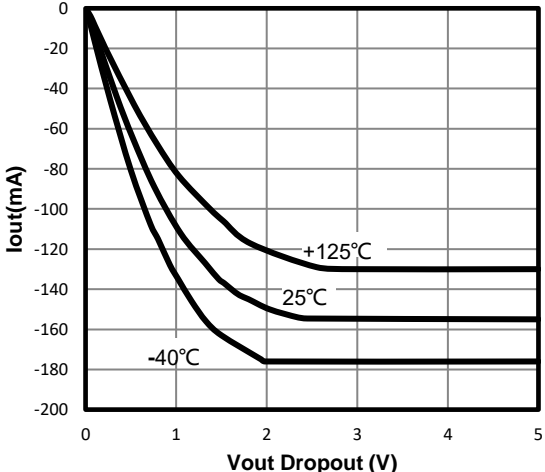

# TP2411 / TP2412 / TP2414

## Low Cost, Low Noise CMOS RRIO Op-amps

### Pin Functions

**-IN:** Inverting Input of the Amplifier.

**+IN:** Non-Inverting Input of Amplifier.

**OUT:** Amplifier Output. The voltage range extends to within mV of each supply rail.

**V+ or +Vs:** Positive Power Supply. Typically the voltage is from 2.2V to 5.5V. Split supplies are possible as long as the voltage between V+ and V- is between 2.2V and 5.5V. A bypass capacitor of 0.1 $\mu$ F as close to the part as

possible should be used between power supply pins or between supply pins and ground.

**V- or -Vs:** Negative Power Supply. It is normally tied to ground. It can also be tied to a voltage other than ground as long as the voltage between V+ and V- is from 2.2V to 5.5V. If it is not connected to ground, bypass it with a capacitor of 0.1 $\mu$ F as close to the part as possible.

### Operation

The TP2411 series op amps can operate on a single-supply voltage (2.2 V to 5.5 V), or a split-supply voltage ( $\pm 1.1$  V to  $\pm 2.75$  V), making them highly versatile and easy to use. The power-supply pins should have local bypass ceramic capacitors (typically 0.001  $\mu$ F to 0.1  $\mu$ F). These amplifiers are fully specified from +2.2 V to +5.5 V and over the extended temperature range of  $-40^{\circ}\text{C}$  to  $+125^{\circ}\text{C}$ . Parameters that can exhibit variance with regard to operating voltage or temperature are presented in the Typical Characteristics.

## Applications Information

### Input ESD Diode Protection

The TP2411 incorporates internal electrostatic discharge (ESD) protection circuits on all pins. In the case of input and output pins, this protection primarily consists of current-steering diodes connected between the input and power-supply pins. These ESD protection diodes also provide in-circuit input overdrive protection, as long as the current is limited to 10 mA as stated in the Absolute Maximum Ratings table. Many input signals are inherently current-limited to less than 10 mA; therefore, a limiting resistor is not required. Figure 1 shows how a series input resistor ( $R_S$ ) may be added to the driven input to limit the input current. The added resistor contributes thermal noise at the amplifier input and the value should be kept to the minimum in noise-sensitive applications.

Current-limiting resistor required if input voltage exceeds supply rails by  $>0.5\text{V}$ .

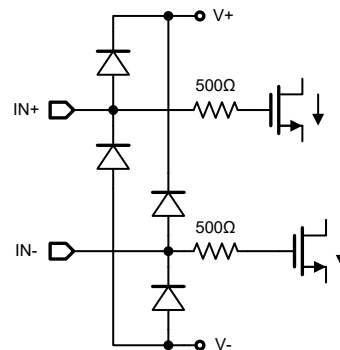
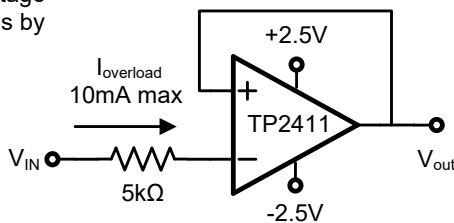

INPUT ESD DIODE CURRENT LIMITING- UNITY GAIN



## Dual/Quad 36V Ultra Low Distortion OPAMP

## EMI SUSCEPTIBILITY AND INPUT FILTERING

Operational amplifiers vary in susceptibility to electromagnetic interference (EMI). If conducted EMI enters the device, the dc offset observed at the amplifier output may shift from the nominal value while EMI is present. This shift is a result of signal rectification associated with the internal semiconductor junctions. While all operational amplifier pin functions can be affected by EMI, the input pins are likely to be the most susceptible. The TP2411 operational amplifier family incorporates an internal input low-pass filter that reduces the amplifier response to EMI. Both common-mode and differential mode filtering are provided by the input filter. The filter is designed for a cutoff frequency of approximately 500 MHz (–3 dB), with a roll-off of 20 dB per decade.

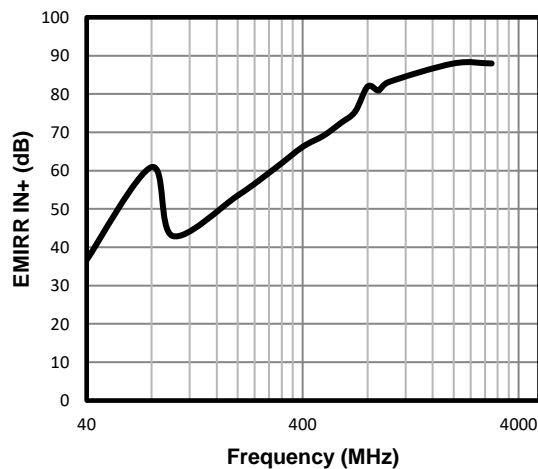

Figure 2. TP2411 EMIRR IN+ vs Frequency

## PCB Surface Leakage

In applications where low input bias current is critical, Printed Circuit Board (PCB) surface leakage effects need to be considered. Surface leakage is caused by humidity, dust or other contamination on the board. Under low humidity conditions, a typical resistance between nearby traces is  $10^{12}\Omega$ . A 5V difference would cause 5pA of current to flow, which is greater than the TP2411/2412/2414 OPA's input bias current at +27°C ( $\pm 3\text{pA}$ , typical). It is recommended to use multi-layer PCB layout and route the OPA's -IN and +IN signal under the PCB surface.

The effective way to reduce surface leakage is to use a guard ring around sensitive pins (or traces). The guard ring is biased at the same voltage as the sensitive pin. An example of this type of layout is shown in Figure 1 for Inverting Gain application.

## 1. For Non-Inverting Gain and Unity-Gain Buffer:

- Connect the non-inverting pin ( $V_{IN+}$ ) to the input with a wire that does not touch the PCB surface.
- Connect the guard ring to the inverting input pin ( $V_{IN-}$ ). This biases the guard ring to the Common Mode input voltage.

## 2. For Inverting Gain and Trans-impedance Gain Amplifiers (convert current to voltage, such as photo detectors):

- Connect the guard ring to the non-inverting input pin ( $V_{IN+}$ ). This biases the guard ring to the same reference voltage as the op-amp (e.g.,  $V_{DD}/2$  or ground).
- Connect the inverting pin ( $V_{IN-}$ ) to the input with a wire that does not touch the PCB surface.

## Dual/Quad 36V Ultra Low Distortion OPAMP

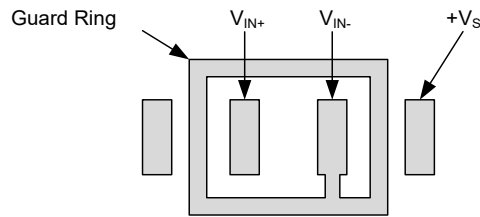

Figure 3 The Layout of Guard Ring

### Power Supply Layout and Bypass

The TP2411/2412/2412 OPA's power supply pin ( $V_{DD}$  for single-supply) should have a local bypass capacitor (i.e.,  $0.01\mu\text{F}$  to  $0.1\mu\text{F}$ ) within 2mm for good high frequency performance. It can also use a bulk capacitor (i.e.,  $1\mu\text{F}$  or larger) within 100mm to provide large, slow currents. This bulk capacitor can be shared with other analog parts.

Ground layout improves performance by decreasing the amount of stray capacitance and noise at the OPA's inputs and outputs. To decrease stray capacitance, minimize PCB board lengths and resistor leads, and place external components as close to the op amps' pins as possible.

### Proper Board Layout

To ensure optimum performance at the PCB level, care must be taken in the design of the board layout. To avoid leakage currents, the surface of the board should be kept clean and free of moisture. Coating the surface creates a barrier to moisture accumulation and helps reduce parasitic resistance on the board.

Keeping supply traces short and properly bypassing the power supplies minimizes power supply disturbances due to output current variation, such as when driving an ac signal into a heavy load. Bypass capacitors should be connected as closely as possible to the device supply pins. Stray capacitances are a concern at the outputs and the inputs of the amplifier. It is recommended that signal traces be kept at least 5mm from supply lines to minimize coupling.

A variation in temperature across the PCB can cause a mismatch in the Seebeck voltages at solder joints and other points where dissimilar metals are in contact, resulting in thermal voltage errors. To minimize these thermocouple effects, orient resistors so heat sources warm both ends equally. Input signal paths should contain matching numbers and types of components, where possible to match the number and type of thermocouple junctions. For example, dummy components such as zero value resistors can be used to match real resistors in the opposite input path. Matching components should be located in close proximity and should be oriented in the same manner. Ensure leads are of equal length so that thermal conduction is in equilibrium. Keep heat sources on the PCB as far away from amplifier input circuitry as is practical.

The use of a ground plane is highly recommended. A ground plane reduces EMI noise and also helps to maintain a constant temperature across the circuit board.

**Package Outline Dimensions**

SOT23-5

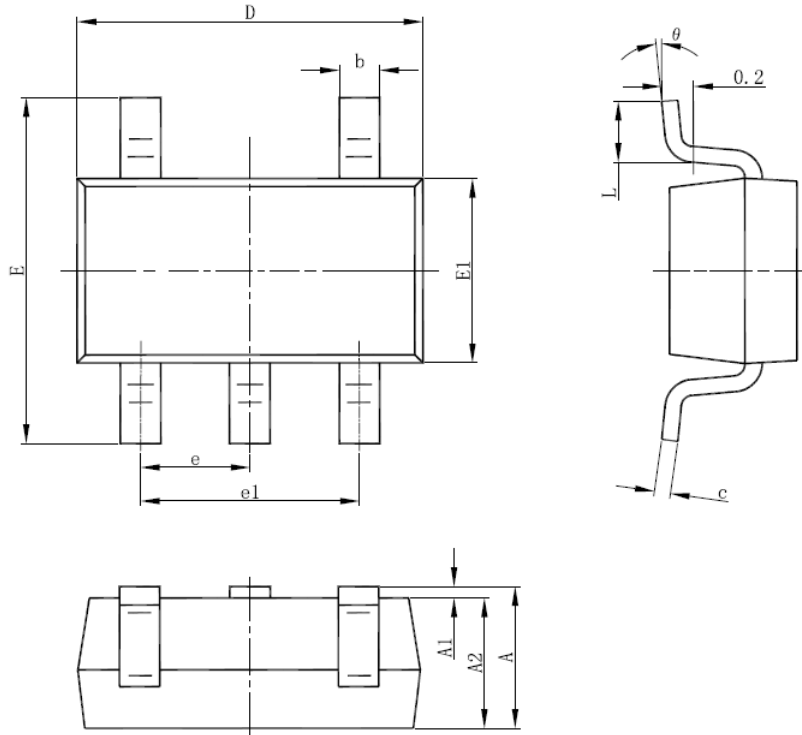

Symbol	Dimensions In Millimeters		Dimensions In Inches	
	Min.	Max.	Min.	Max.
A	1.050	1.250	0.041	0.049
A1	0.000	0.100	0.000	0.004
A2	1.050	1.150	0.041	0.045
b	0.300	0.500	0.012	0.020
c	0.100	0.200	0.004	0.008
D	2.820	3.020	0.111	0.119
E1	1.500	1.700	0.059	0.067
E	2.650	2.950	0.104	0.116
e	0.950(BSC)		0.037(BSC)	
e1	1.800	2.000	0.071	0.079
L	0.300	0.600	0.012	0.024
θ	0°	8°	0°	8°

# TP2411 / TP2412 / TP2414

Low Cost, Low Noise CMOS RRIO Op-amps

## Package Outline Dimensions

SOT-23-8

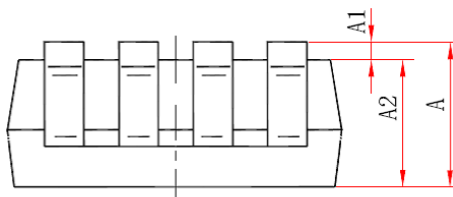
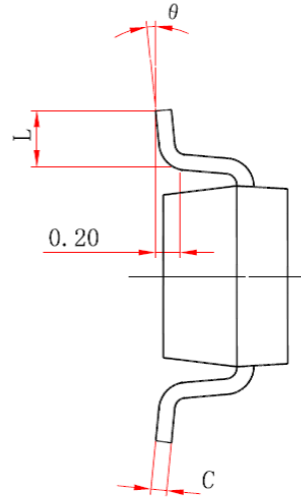
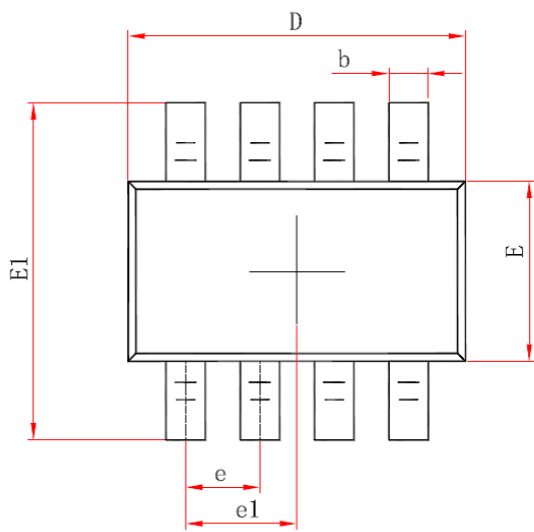

Symbol	Dimensions In Millimeters		Dimensions In Inches	
	Min	Max	Min	Max
A	1.050	1.250	0.041	0.049
A1	0.000	0.100	0.000	0.004
A2	1.050	1.150	0.041	0.045
b	0.300	0.500	0.012	0.020
c	0.100	0.200	0.004	0.008
D	2.820	3.020	0.111	0.119
E	1.500	1.700	0.059	0.067
E1	2.600	3.000	0.102	0.118
e	0.65 (BSC)		0.026(BSC)	
e1	0.975 (BSC)		0.038(BSC)	
L	0.300	0.600	0.012	0.024
$\theta$	0°	8°	0°	8°

Package Outline Dimensions

SOP-8

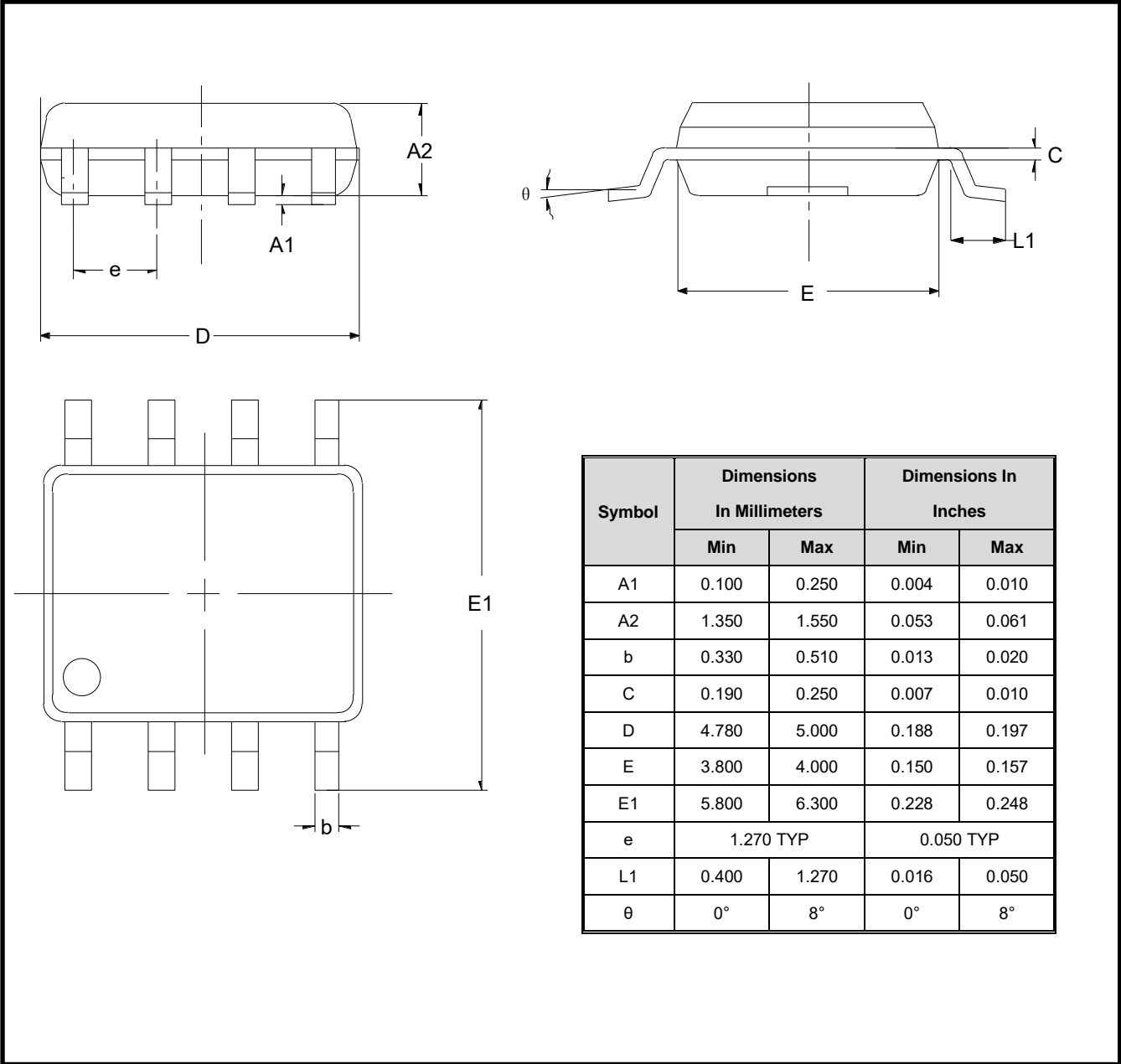

Symbol	Dimensions In Millimeters		Dimensions In Inches	
	Min	Max	Min	Max
A1	0.100	0.250	0.004	0.010
A2	1.350	1.550	0.053	0.061
b	0.330	0.510	0.013	0.020
C	0.190	0.250	0.007	0.010
D	4.780	5.000	0.188	0.197
E	3.800	4.000	0.150	0.157
E1	5.800	6.300	0.228	0.248
e	1.270 TYP		0.050 TYP	
L1	0.400	1.270	0.016	0.050
θ	0°	8°	0°	8°

# TP2411 / TP2412 / TP2414

## Low Cost, Low Noise CMOS RRIO Op-amps

### Package Outline Dimensions

MSOP-8

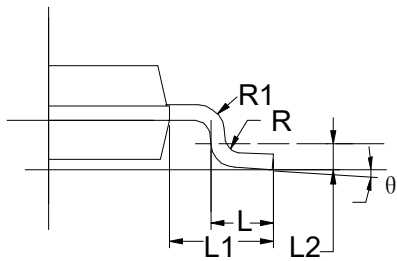
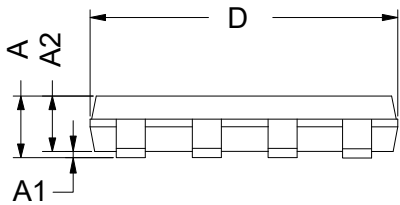
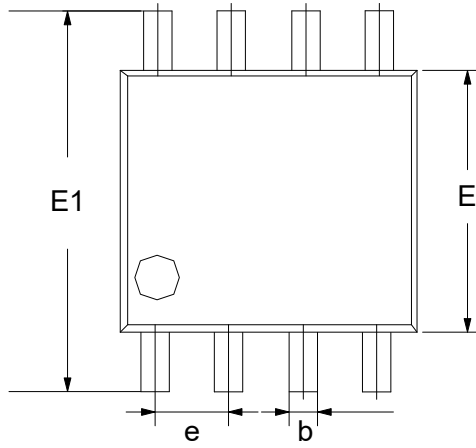

Symbol	Dimensions In Millimeters		Dimensions In Inches	
	Min	Max	Min	Max
A	0.800	1.200	0.031	0.047
A1	0.000	0.200	0.000	0.008
A2	0.760	0.970	0.030	0.038
b	0.30 TYP		0.012 TYP	
C	0.15 TYP		0.006 TYP	
D	2.900	3.100	0.114	0.122
e	0.65 TYP		0.026	
E	2.900	3.100	0.114	0.122
E1	4.700	5.100	0.185	0.201
L1	0.410	0.650	0.016	0.026
θ	0°	6°	0°	6°

Package Outline Dimensions

TSSOP-8

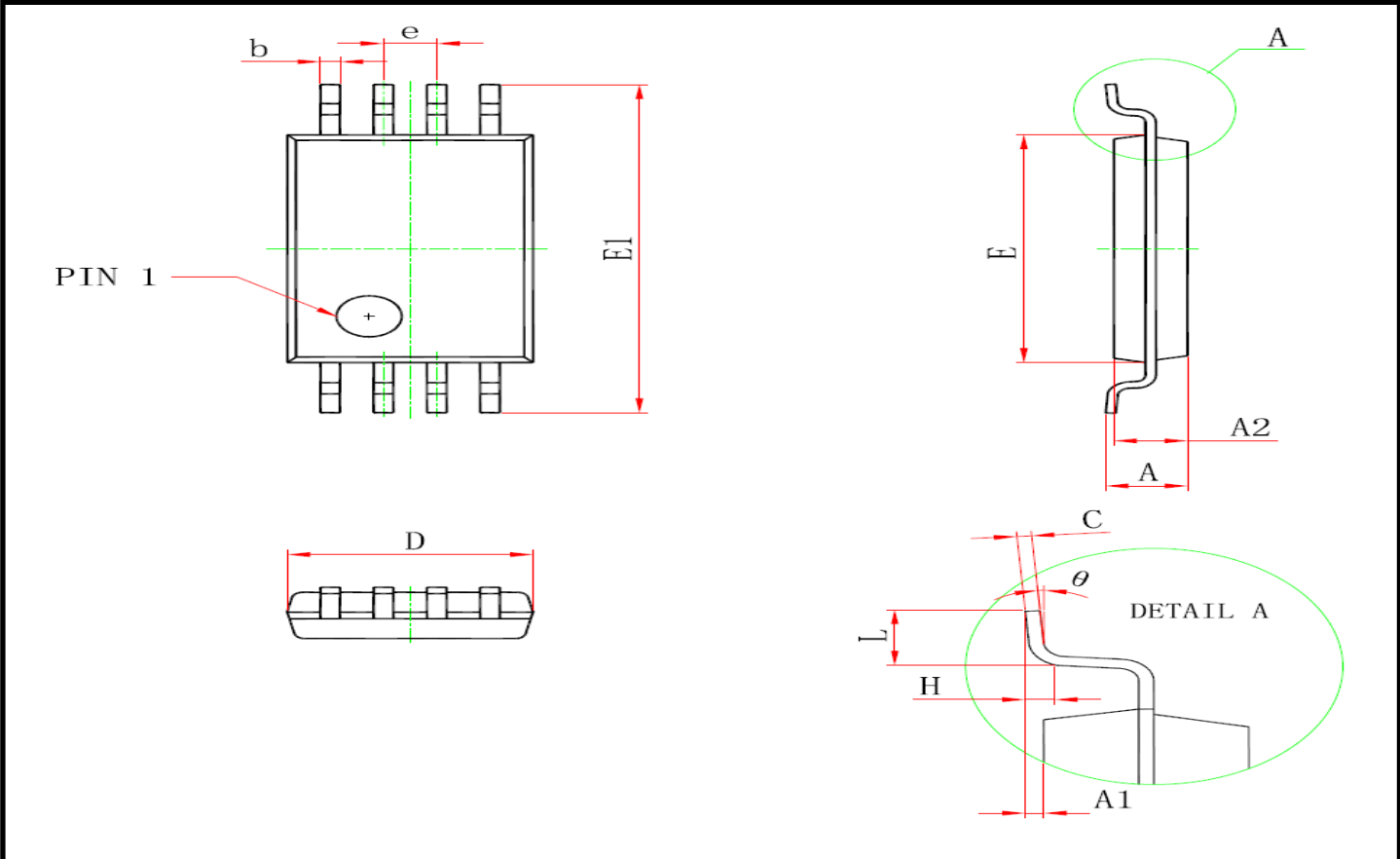

Symbol	Dimensions In Millimeters		Dimensions In Inches	
	Min	Max	Min	Max
D	2.900	3.100	0.114	0.122
E	4.300	4.500	0.169	0.177
b	0.190	0.300	0.007	0.012
c	0.090	0.200	0.004	0.008
E1	6.250	6.550	0.246	0.258
A		1.200		0.047
A2	0.800	1.000	0.031	0.039
A1	0.050	0.150	0.002	0.006
e	0.65(BSC)		0.026 (BSC)	
L	0.500	0.700	0.020	0.028
H	0.25(BSC)		0.01 (BSC)	
$\theta$	1°	7°	1°	7°

# TP2411 / TP2412 / TP2414

Low Cost, Low Noise CMOS RRIO Op-amps

## Package Outline Dimensions

TSSOP-14

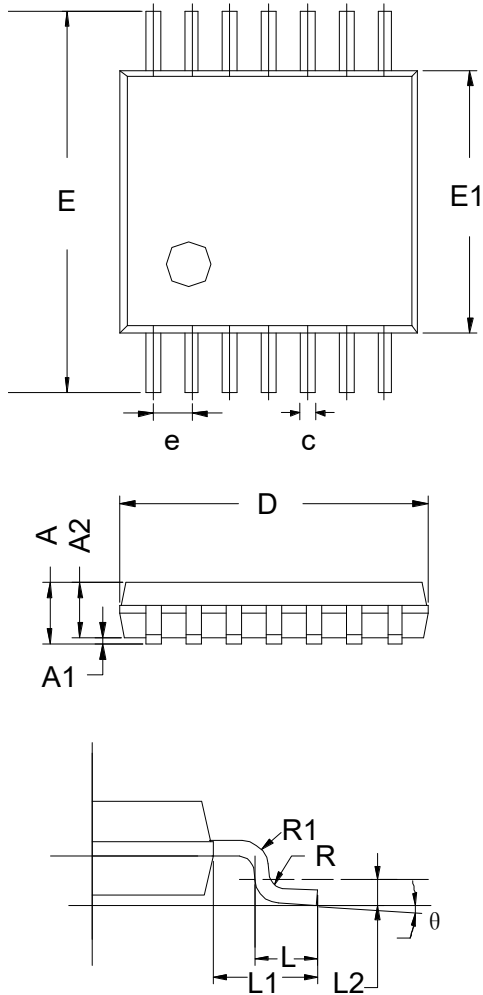

Symbol	Dimensions In Millimeters		
	MIN	TYP	MAX
A	-	-	1.20
A1	0.05	-	0.15
A2	0.90	1.00	1.05
b	0.20	-	0.28
c	0.10	-	0.19
D	4.86	4.96	5.06
E	6.20	6.40	6.60
E1	4.30	4.40	4.50
e	0.65 BSC		
L	0.45	0.60	0.75
L1	1.00 REF		
L2	0.25 BSC		
R	0.09	-	-
θ	0°	-	8°



Package Outline Dimensions

SOP-14

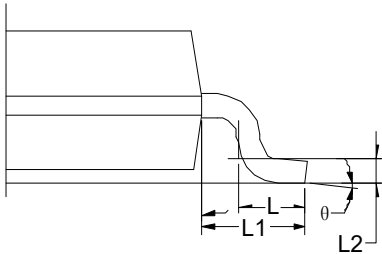
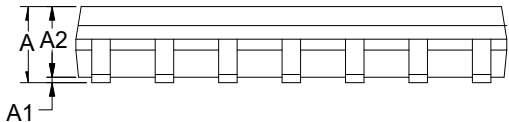
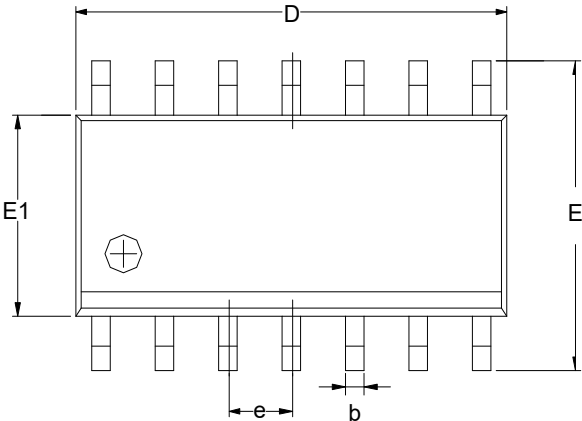

Symbol	Dimensions In Millimeters		
	MIN	TYP	MAX
A	1.35	1.60	1.75
A1	0.10	0.15	0.25
A2	1.25	1.45	1.65
b	0.36		0.49
D	8.53	8.63	8.73
E	5.80	6.00	6.20
E1	3.80	3.90	4.00
e	1.27 BSC		
L	0.45	0.60	0.80
L1	1.04 REF		
L2	0.25 BSC		
θ	0°		8°

# TP2411 / TP2412 / TP2414

## Low Cost, Low Noise CMOS RRIO Op-amps

---

### Revision History

Date	Revision	Notes
2022/4/30	B.5	Update order information.