

### GENERAL DESCRIPTION

The SGM2048 is a low noise, high PSRR, low dropout voltage linear regulator. It is capable of supplying 1A output current with typical dropout voltage of only 150mV. The operating input voltage range is from 2.2V to 7V. The SGM2048 is available in fixed output voltage versions and an adjustable version that allows the output voltage range from 0.8V to 6V.

Other features include logic-controlled shutdown mode, short-circuit current limit and thermal shutdown protection. The SGM2048 has automatic discharge function to quickly discharge  $V_{OUT}$  in the disabled status.

The SGM2048 is available in a Green TDFN-3×3-8CL package. It operates over an operating temperature range of -40°C to +125°C.

### FEATURES

- **Operating Input Voltage Range: 2.2V to 7V**
- **Fixed Outputs of 1.2V, 1.8V, 2.8V, 3.0V, 3.3V, 5.0V**
- **Adjustable Output from 0.8V to 6V**
- **Output Voltage Accuracy: ±1% at +25°C**
- **Low Dropout Voltage: 150mV (TYP) at 1A**
- **Low Noise: 30 $\mu$ V<sub>RMS</sub> (TYP)**
- **Power Supply Rejection Ratio at  $V_{OUT} = 3.3V$ :**
  - ◆ 75dB at 1kHz
  - ◆ 65dB at 100kHz
  - ◆ 55dB at 1MHz
- **Current Limiting and Thermal Protection**
- **Excellent Load and Line Transient Responses**
- **With Output Automatic Discharge**
- **Stable with Small Case Size Ceramic Capacitors**
- **-40°C to +125°C Operating Temperature Range**
- **Available in a Green TDFN-3×3-8CL Package**

### APPLICATIONS

Wireless Basestation  
 PLL/VCO/RF Circuit  
 Audio Equipment

### TYPICAL APPLICATION

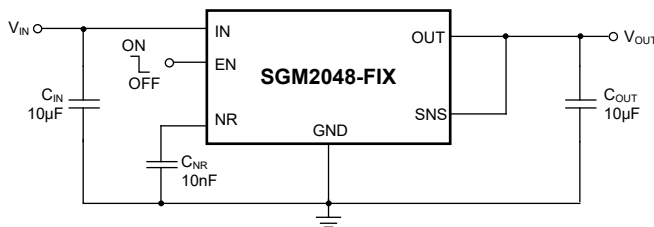

Fixed Voltage Typical Application Circuit

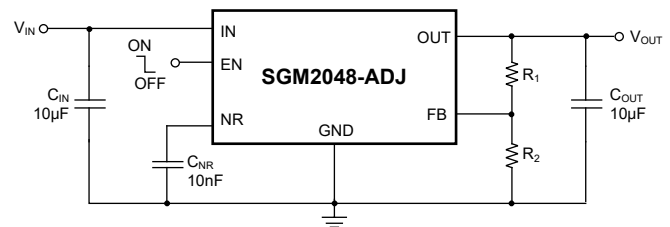

Adjustable Voltage Typical Application Circuit

Figure 1. Typical Application Circuits

## PACKAGE/ORDERING INFORMATION

| MODEL       | PACKAGE DESCRIPTION | SPECIFIED TEMPERATURE RANGE | ORDERING NUMBER      | PACKAGE MARKING          | PACKING OPTION      |
|-------------|---------------------|-----------------------------|----------------------|--------------------------|---------------------|
| SGM2048-1.2 | TDFN-3×3-8CL        | -40°C to +125°C             | SGM2048-1.2XTEK8G/TR | SGMSXU<br>XTEK8<br>XXXXX | Tape and Reel, 4000 |
| SGM2048-1.8 | TDFN-3×3-8CL        | -40°C to +125°C             | SGM2048-1.8XTEK8G/TR | SGMSXV<br>XTEK8<br>XXXXX | Tape and Reel, 4000 |
| SGM2048-2.8 | TDFN-3×3-8CL        | -40°C to +125°C             | SGM2048-2.8XTEK8G/TR | SGMSXW<br>XTEK8<br>XXXXX | Tape and Reel, 4000 |
| SGM2048-3.0 | TDFN-3×3-8CL        | -40°C to +125°C             | SGM2048-3.0XTEK8G/TR | SGMSXX<br>XTEK8<br>XXXXX | Tape and Reel, 4000 |
| SGM2048-3.3 | TDFN-3×3-8CL        | -40°C to +125°C             | SGM2048-3.3XTEK8G/TR | SGMSXY<br>XTEK8<br>XXXXX | Tape and Reel, 4000 |
| SGM2048-5.0 | TDFN-3×3-8CL        | -40°C to +125°C             | SGM2048-5.0XTEK8G/TR | SGMRB0<br>XTEK8<br>XXXXX | Tape and Reel, 4000 |
| SGM2048-ADJ | TDFN-3×3-8CL        | -40°C to +125°C             | SGM2048-ADJXTEK8G/TR | SGMRAF<br>XTEK8<br>XXXXX | Tape and Reel, 4000 |

## MARKING INFORMATION

NOTE: XXXXX = Date Code, Trace Code and Vendor Code.

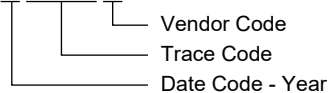
**XXXXX**

Green (RoHS & HSF): SG Micro Corp defines "Green" to mean Pb-Free (RoHS compatible) and free of halogen substances. If you have additional comments or questions, please contact your SGMICRO representative directly.

**ABSOLUTE MAXIMUM RATINGS**

|  |                 |
|--|-----------------|
| IN, OUT to GND.....                    | -0.3V to 8V     |
| FB, NR to GND.....                     | -0.3V to 3.6V   |
| EN to GND.....                         | -0.3V to 7V     |
| Package Thermal Resistance             |                 |
| TDFN-3×3-8CL, $\theta_{JA}$ .....      | 53°C/W          |
| Junction Temperature.....              | +150°C          |
| Storage Temperature Range .....        | -65°C to +150°C |
| Lead Temperature (Soldering, 10s)..... | +260°C          |
| ESD Susceptibility                     |                 |
| HBM.....                               | 6000V           |
| CDM .....                              | 1000V           |

**RECOMMENDED OPERATING CONDITIONS**

|   |                          |
|---|--------------------------|
| Operating Input Voltage Range, $V_{IN}$ ..... | 2.2V to 7V               |
| Adjustable Output Voltage Range.....          | 0.8V to 6V               |
| Fixed Output Voltage Range.....               | 1.2V to 5V               |
| Enable Voltage Range .....                    | 0V to 7V                 |
| Input Effective Capacitance, $C_{IN}$ .....   | 4 $\mu$ F (MIN)          |
| Output Effective Capacitance, $C_{OUT}$ ..... | 4 $\mu$ F to 100 $\mu$ F |
| Noise Reduction Capacitance, $C_{NR}$ .....   | 1nF (MIN)                |
| Operating Junction Temperature Range .....    | -40°C to +125°C          |

**OVERSTRESS CAUTION**

Stresses beyond those listed in Absolute Maximum Ratings may cause permanent damage to the device. Exposure to absolute maximum rating conditions for extended periods may affect reliability. Functional operation of the device at any conditions beyond those indicated in the Recommended Operating Conditions section is not implied.

**ESD SENSITIVITY CAUTION**

This integrated circuit can be damaged if ESD protections are not considered carefully. SGMICRO recommends that all integrated circuits be handled with appropriate precautions. Failure to observe proper handling and installation procedures can cause damage. ESD damage can range from subtle performance degradation to complete device failure. Precision integrated circuits may be more susceptible to damage because even small parametric changes could cause the device not to meet the published specifications.

**DISCLAIMER**

SG Micro Corp reserves the right to make any change in circuit design, or specifications without prior notice.

## PIN CONFIGURATIONS

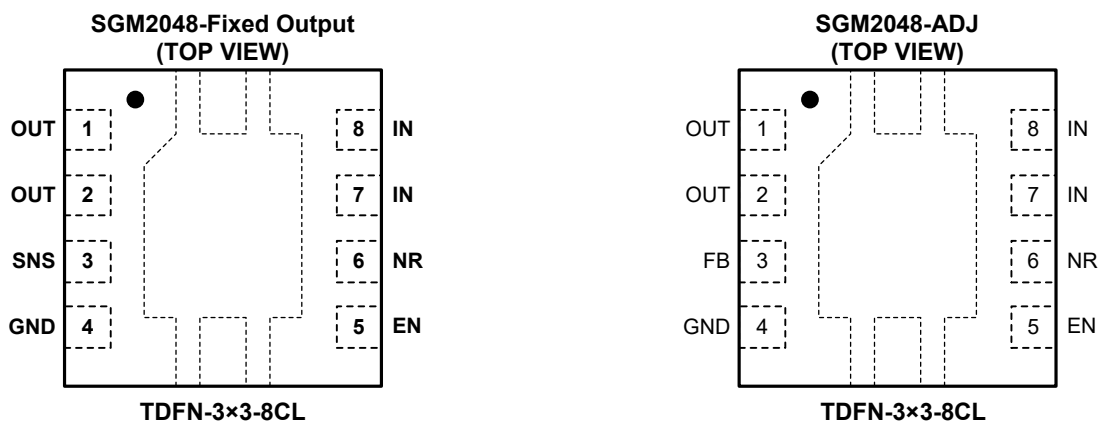

## PIN DESCRIPTION

| PIN         | NAME | FUNCTION  |
|-------------|------|---|
| 1, 2        | OUT  | Regulator Output Pin. It is recommended to use a ceramic capacitor with effective capacitance in the range of 4 $\mu$ F to 100 $\mu$ F to ensure stability. This ceramic capacitor should be placed as close as possible to OUT pin.  |
| 3           | FB   | Feedback Voltage Input Pin (adjustable voltage version only). Connect this pin to the midpoint of an external resistor divider to adjust the output voltage. Place the resistors as close as possible to this pin.  |
|             | SNS  | Output Voltage Sense Input Pin (fixed voltage version only). Connect this pin to the load side of the output trace only in the fixed voltage version.   |
| 4           | GND  | Ground.   |
| 5           | EN   | Enable Pin. Drive EN high to turn on the regulator. Drive EN low to turn off the regulator. The EN pin has an internal pull-down current source which ensures that the device is turned off when the EN pin is floated. This pin must be pulled high by an external resistor connected to IN pin if EN pin is not used. |
| 6           | NR   | Noise-Reduction Pin. Using an external capacitor $C_{NR}$ to decouple this pin to GND can not only reduce output noise to very low level but also slow down the $V_{OUT}$ rise like a soft-start behavior.  |
| 7, 8        | IN   | Input Supply Voltage Pin. It is recommended to use a 4.7 $\mu$ F or larger ceramic capacitor from IN pin to ground to get good power supply decoupling. This ceramic capacitor should be placed as close as possible to IN pin.   |
| Exposed Pad | –    | Exposed Pad. Connect it to a large ground plane to maximize thermal performance; this pad is not an electrical connection point.  |

**ELECTRICAL CHARACTERISTICS**

( $V_{IN} = (V_{OUT(NOM)} + 0.5V)$  or 2.2V (whichever is greater),  $V_{EN} = 2.2V$ ,  $I_{OUT} = 1mA$ ,  $C_{IN} = C_{OUT} = 4.7\mu F$  and  $C_{NR} = 10nF$ . For SGM2048-ADJ, tested at  $V_{OUT} = 0.8V$ ,  $T_J = -40^\circ C$  to  $+125^\circ C$ , typical values are at  $T_J = +25^\circ C$ , unless otherwise noted.)

| PARAMETER                        | SYMBOL  | CONDITIONS   | MIN                                    | TYP   | MAX   | UNITS         |
|----------------------------------|---|--|--|-------|-------|---------------|
| Output Voltage Range             | $V_{OUT}$   | Adjustable voltage version   | 0.8                                    |       | 6     | V             |
|                                  |   | Fixed voltage version  | 1.2                                    |       | 5     |               |
| Internal Reference Voltage       | $V_{NR}$  | Adjustable and Fixed voltage versions, $V_{OUT} < 1.8V$  | 0.789                                  | 0.8   | 0.824 | V             |
|                                  |   | Fixed voltage version, $V_{OUT} \geq 1.8V$   | 1.183                                  | 1.2   | 1.236 |               |
| Under-Voltage Lockout Thresholds | $V_{UVLO}$  | $V_{IN}$ rising, $R_L = 1k\Omega$  | 1.9                                    | 2     | 2.1   | V             |
|                                  |   | Hysteresis   |  | 150   |       | mV            |
| Output Voltage Accuracy          | $V_{OUT}$   | $V_{IN} = (V_{OUT(NOM)} + 0.5V)$ to 7V,<br>$V_{IN} \geq 2.2V$ , $I_{OUT} = 1mA$ to 1A                    | $T_J = +25^\circ C$                    | -1    | 1     | %             |
|                                  |   |  | $T_J = -40^\circ C$ to $+125^\circ C$  | -2    | 2     |               |
| Shutdown Current                 | $I_{SHDN}$  | $V_{EN} \leq 0.4V$ , $V_{IN} \geq 2.2V$ ,<br>$R_L = 1k\Omega$  | $T_J = -40^\circ C$ to $+85^\circ C$   |       | 1     | $\mu A$       |
|                                  |   |  | $T_J = -40^\circ C$ to $+125^\circ C$  |       | 6     |               |
| Line Regulation                  | $\frac{\Delta V_{OUT}}{\Delta V_{IN} \times V_{OUT}}$ | $V_{IN} = (V_{OUT(NOM)} + 0.5V)$ to 7V, $V_{IN} \geq 2.2V$ ,<br>$I_{OUT} = 100mA$                        |  | 0.004 | 0.029 | %/V           |
| Load Regulation                  | $\Delta V_{OUT}/\Delta I_{OUT}$                       | $I_{OUT} = 1mA$ to 1A  |  | 1     | 15    | $\mu V/mA$    |
| Dropout Voltage                  | $V_{DROP}$  | $V_{FB} = GND$ or $V_{SNS} = GND$  | $V_{IN} \geq 2.2V$ , $I_{OUT} = 500mA$ | 80    | 130   | mV            |
|                                  |   |  | $V_{IN} \geq 2.5V$ , $I_{OUT} = 750mA$ | 115   | 200   |               |
|                                  |   |  | $V_{IN} \geq 2.5V$ , $I_{OUT} = 1A$    | 150   | 260   |               |
| Output Current Limit             | $I_{LIMIT}$   | $V_{OUT} = 90\% \times V_{OUT(NOM)}$ , $V_{IN} = (V_{OUT(NOM)} + 1V)$                                    | 1.05                                   | 1.6   | 2.15  | A             |
| Short Current Limit              | $I_{SHORT}$   | $V_{OUT} = 0V$   |  | 1.6   |       | A             |
| Ground Pin Current               | $I_{GND}$   | $I_{OUT} = 1mA$ , adjustable voltage version   |  | 80    | 115   | $\mu A$       |
|                                  |   | $I_{OUT} = 1mA$ , fixed voltage version  |  | 100   | 150   |               |
|                                  |   | $I_{OUT} = 1A$   |  | 1100  | 1450  |               |
| Feedback Pin Current             | $I_{FB}$  | $V_{IN} = 6.5V$ , $V_{FB} = 0.85V$   |  | 0.001 | 0.1   | $\mu A$       |
| EN Pin High-Level Input Voltage  | $V_{EN(H)}$   | $2.2V < V_{IN} \leq 7V$ , $R_L = 1k\Omega$   | 1.2                                    |       |       | V             |
| EN Pin Low-Level Input Voltage   | $V_{EN(L)}$   |  |  |       | 0.4   | V             |
| EN Pin Current                   | $I_{EN}$  | $V_{IN} = 7V$ , $V_{EN} = 0V$  |  | 0.001 | 1     | $\mu A$       |
|                                  |   | $V_{IN} = V_{EN} = 7V$   |  | 0.13  | 1     |               |
| Start-Up Time                    | $t_{STR}$   | $V_{OUT(NOM)} = 3.3V$ , from assertion of<br>$V_{EN}$ to $90\% \times V_{OUT(NOM)}$ , $R_L = 3.3k\Omega$ | $C_{NR} = 1nF$                         |       | 0.2   | ms            |
|                                  |   |  | $C_{NR} = 10nF$                        |       | 1.8   |               |
| Power Supply Rejection Ratio     | PSRR  | $V_{IN} = 4.3V$ , $V_{OUT(NOM)} = 3.3V$ ,<br>$I_{OUT} = 750mA$ , $C_{NR} = 10nF$                         | $f = 100Hz$                            |       | 78    | dB            |
|                                  |   |  | $f = 1kHz$                             |       | 75    |               |
|                                  |   |  | $f = 10kHz$                            |       | 75    |               |
|                                  |   |  | $f = 100kHz$                           |       | 65    |               |
|                                  |   |  | $f = 1MHz$                             |       | 55    |               |
| Output Voltage Noise             | $e_n$   | $V_{IN} = 4.3V$ , $V_{OUT(NOM)} = 3.3V$ ,<br>$I_{OUT} = 100mA$ , $f = 10Hz$ to $100kHz$                  | $C_{NR} = 1nF$                         |       | 60    | $\mu V_{RMS}$ |
|                                  |   |  | $C_{NR} = 10nF$                        |       | 36    |               |
|                                  |   |  | $C_{NR} = 100nF$                       |       | 30    |               |
| Output Discharge Resistance      | $R_{DIS}$   |  |  | 105   |       | $\Omega$      |
| Thermal Shutdown Temperature     | $T_{SHDN}$  |  |  | 170   |       | $^\circ C$    |
| Thermal Shutdown Hysteresis      | $\Delta T_{SHDN}$                                     |  |  | 20    |       | $^\circ C$    |

TYPICAL PERFORMANCE CHARACTERISTICS

$T_J = +25^{\circ}\text{C}$ ,  $V_{IN} = (V_{OUT(NOM)} + 0.5\text{V})$  or  $2.2\text{V}$  (whichever is greater),  $V_{OUT(NOM)} = 3.3\text{V}$ ,  $V_{EN} = V_{IN}$ ,  $I_{OUT} = 100\text{mA}$ ,  $C_{IN} = C_{OUT} = 4.7\mu\text{F}$ ,  $C_{NR} = 10\text{nF}$ , unless otherwise noted.

Line Transient Response

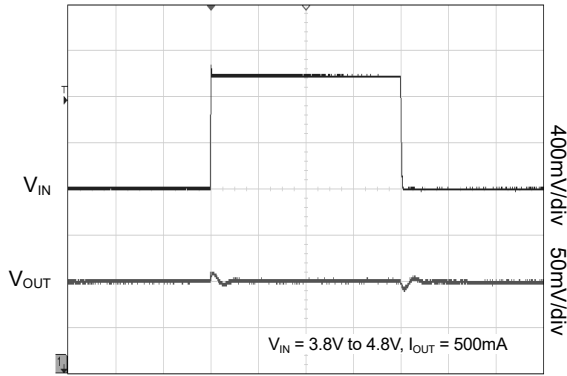

Time (50μs/div)

Load Transient Response

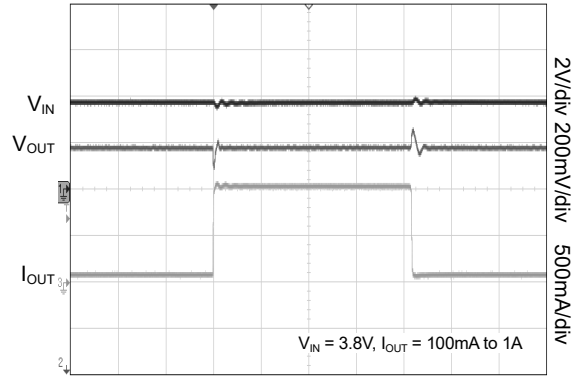

Time (50μs/div)

Enable Pulse Response

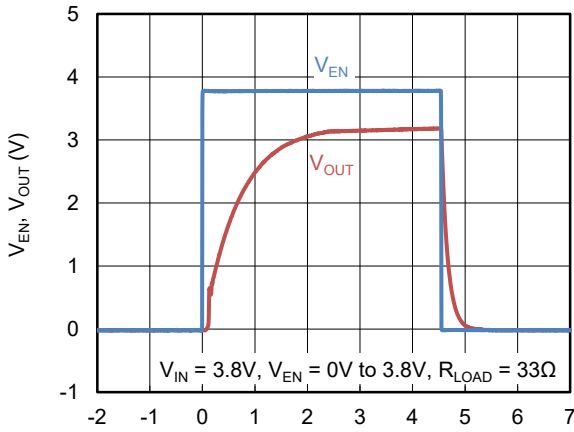

1ms/div

Power-Up and Power-Down Response

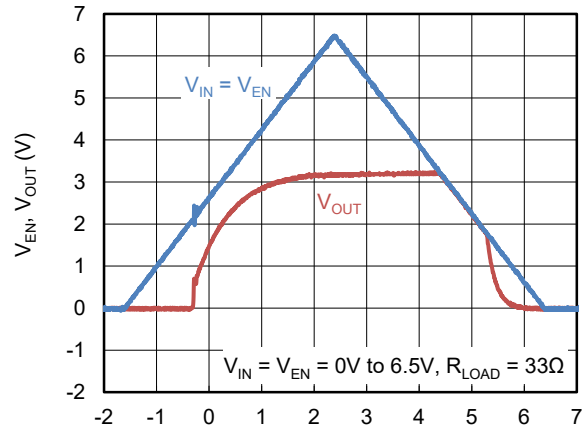

1ms/div

Output Noise Density vs. Frequency

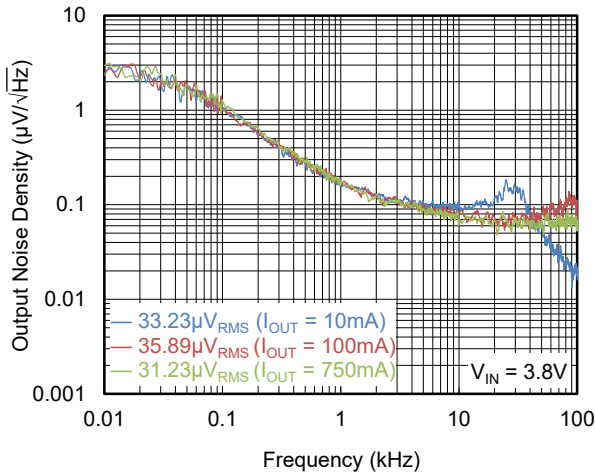

Output Noise Density vs. Frequency

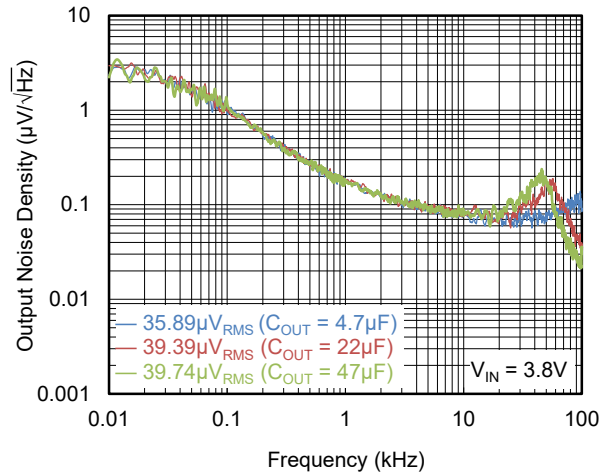

# SGM2048 1A, Low Noise, Wide Bandwidth, High PSRR, Low Dropout Linear Regulator

## TYPICAL PERFORMANCE CHARACTERISTICS (continued)

$T_J = +25^\circ\text{C}$ ,  $V_{IN} = (V_{OUT(NOM)} + 0.5\text{V})$  or  $2.2\text{V}$  (whichever is greater),  $V_{OUT(NOM)} = 3.3\text{V}$ ,  $V_{EN} = V_{IN}$ ,  $I_{OUT} = 100\text{mA}$ ,  $C_{IN} = C_{OUT} = 4.7\mu\text{F}$ ,  $C_{NR} = 10\text{nF}$ , unless otherwise noted.

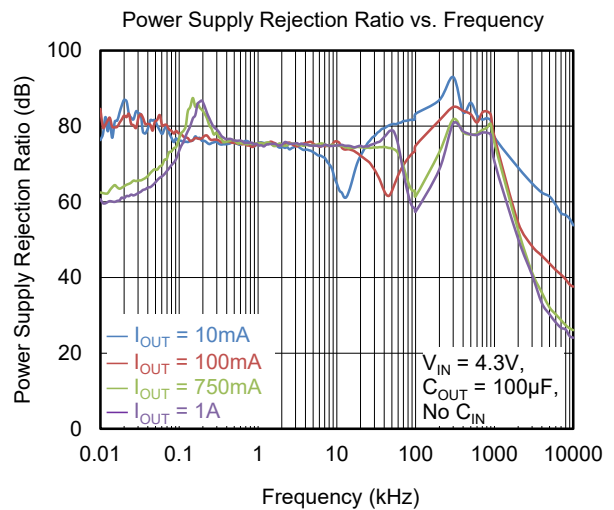
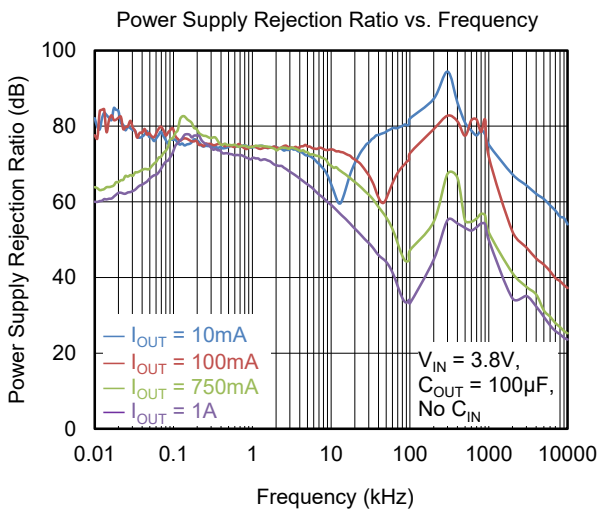
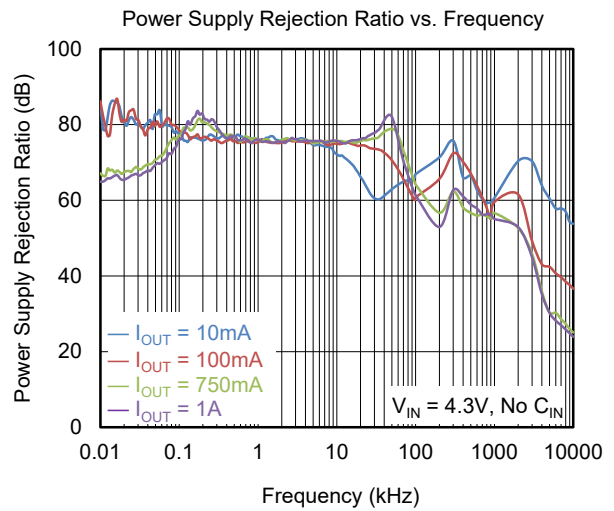
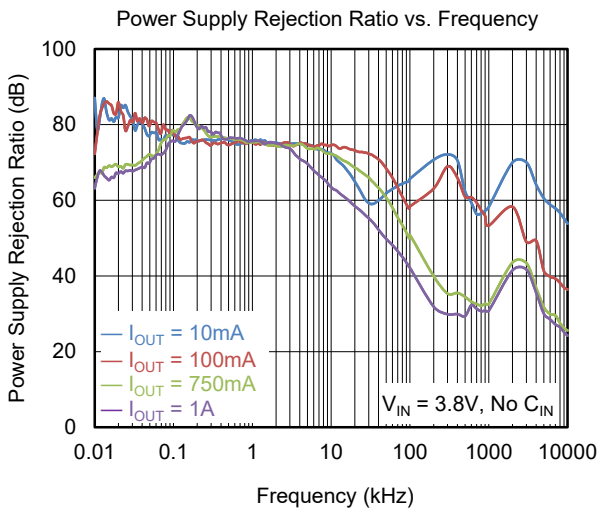
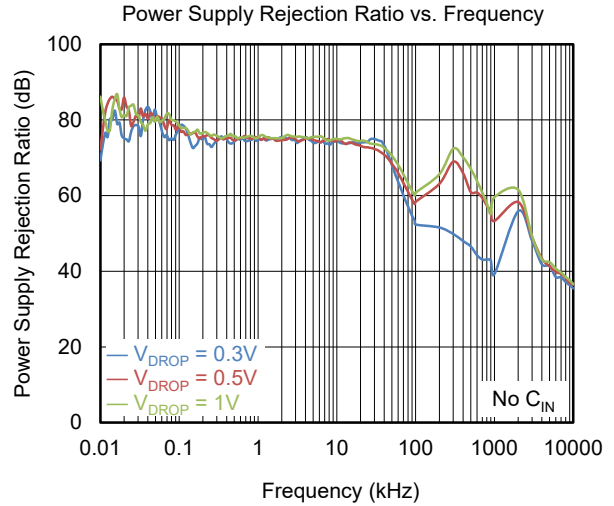
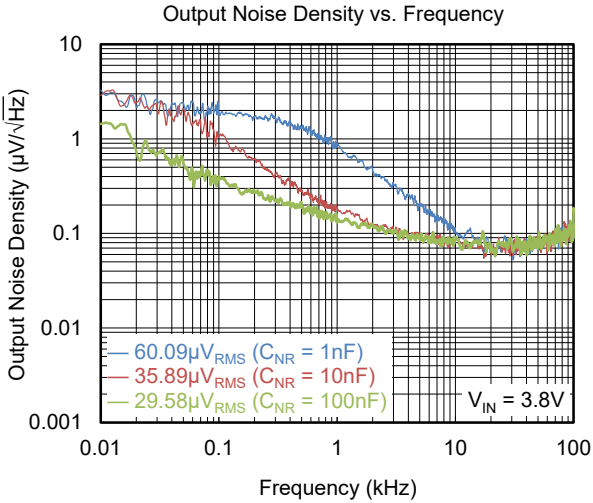

TYPICAL PERFORMANCE CHARACTERISTICS (continued)

$T_J = +25^\circ\text{C}$ ,  $V_{IN} = (V_{OUT(NOM)} + 0.5\text{V})$  or  $2.2\text{V}$  (whichever is greater),  $V_{OUT(NOM)} = 3.3\text{V}$ ,  $V_{EN} = V_{IN}$ ,  $I_{OUT} = 100\text{mA}$ ,  $C_{IN} = C_{OUT} = 4.7\mu\text{F}$ ,  $C_{NR} = 10\text{nF}$ , unless otherwise noted.

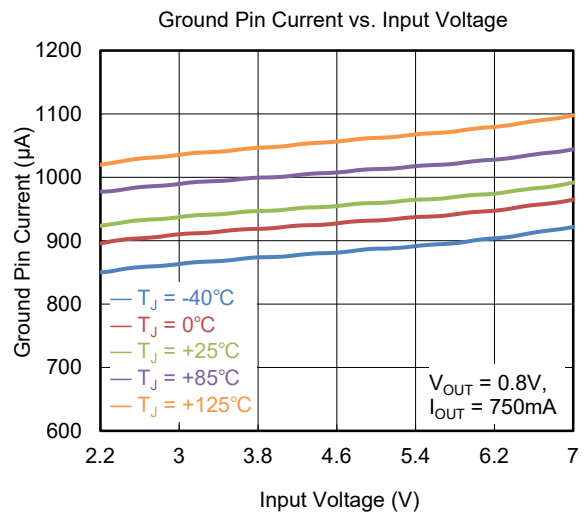
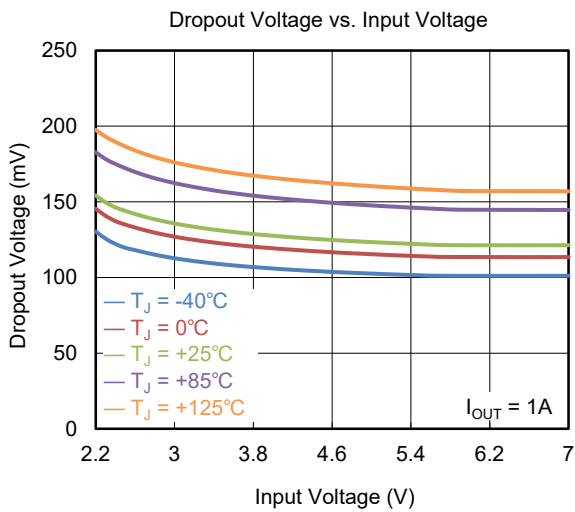
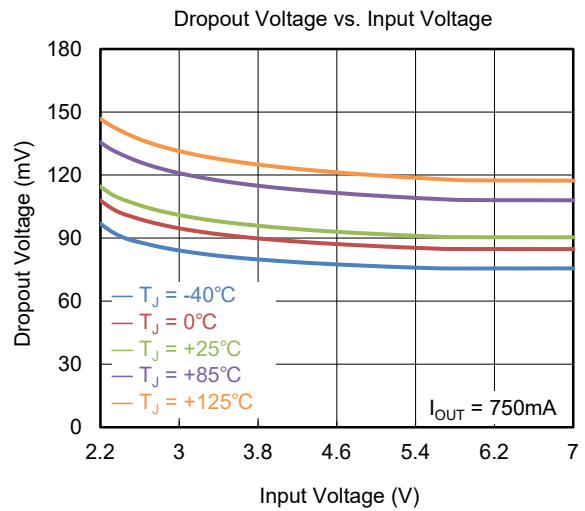
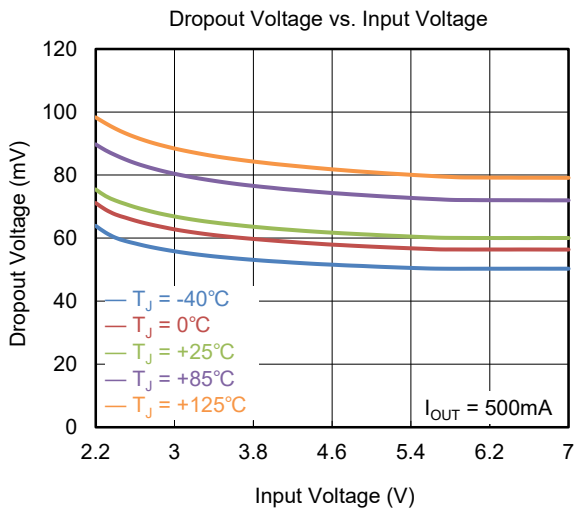
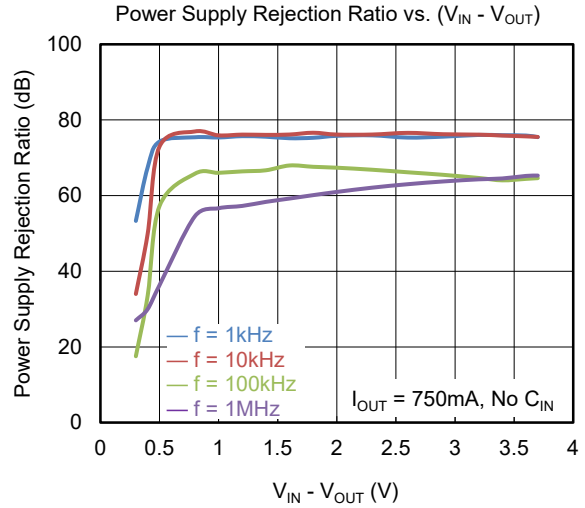
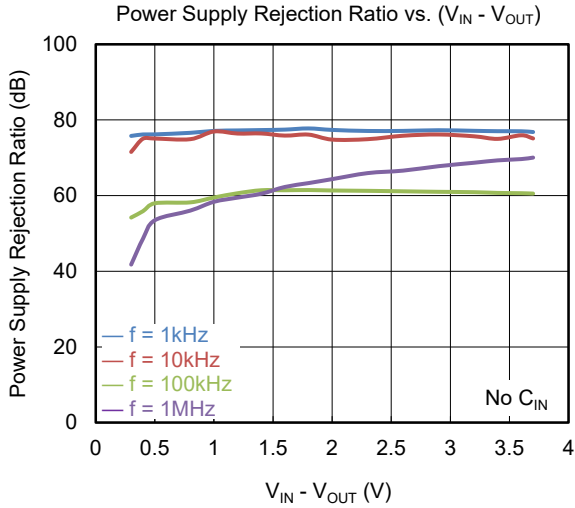



TYPICAL PERFORMANCE CHARACTERISTICS (continued)

$T_J = +25^\circ\text{C}$ ,  $V_{IN} = (V_{OUT(NOM)} + 0.5\text{V})$  or  $2.2\text{V}$  (whichever is greater),  $V_{OUT(NOM)} = 3.3\text{V}$ ,  $V_{EN} = V_{IN}$ ,  $I_{OUT} = 100\text{mA}$ ,  $C_{IN} = C_{OUT} = 4.7\mu\text{F}$ ,  $C_{NR} = 10\text{nF}$ , unless otherwise noted.

Load Regulation

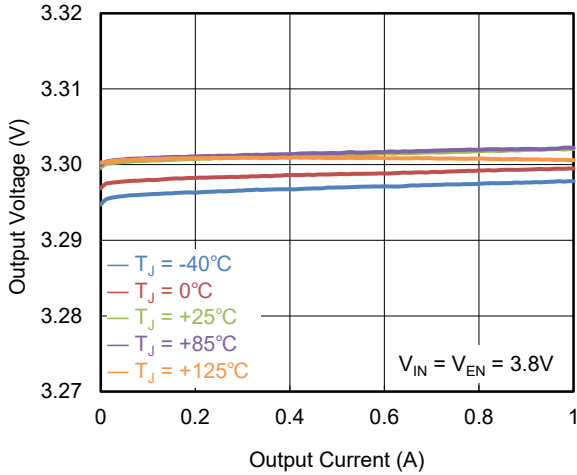

Load Regulation Under Light Loads

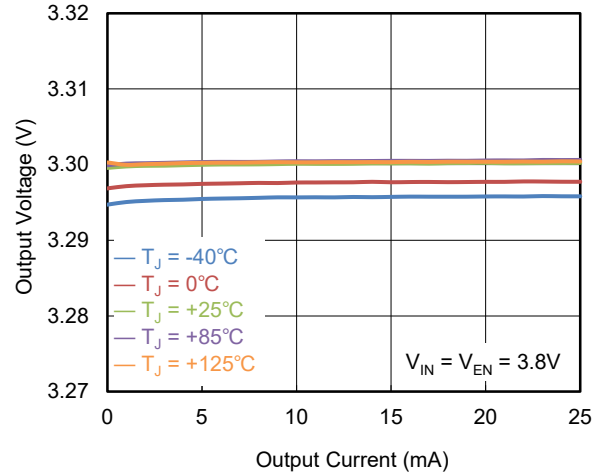

Line Regulation

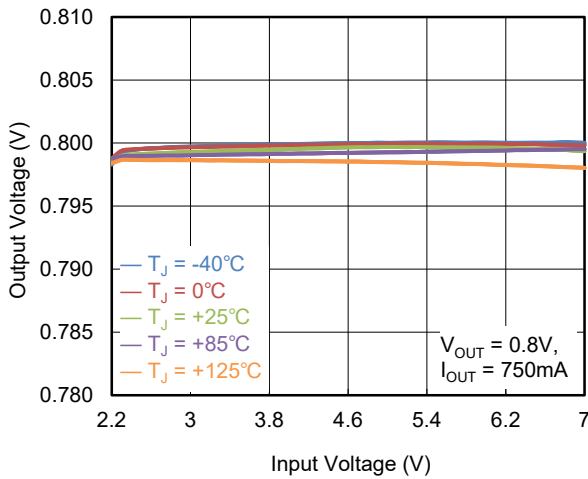

Line Regulation Under Light Loads

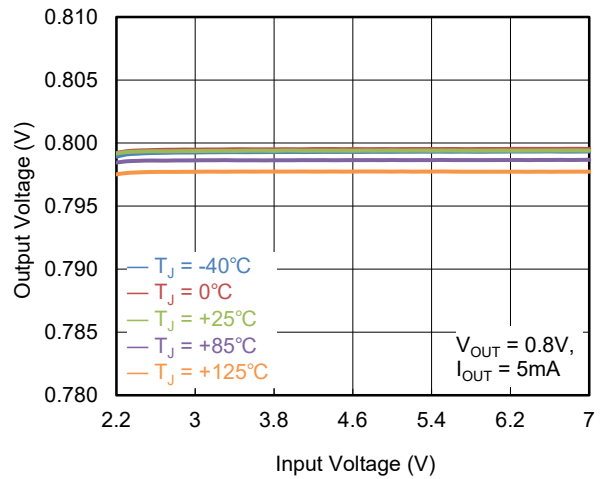

Dropout Voltage vs. Output Current

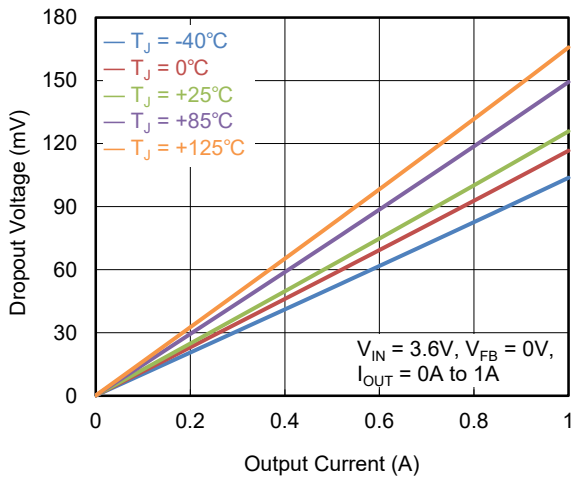

Ground Pin Current vs. Output Current

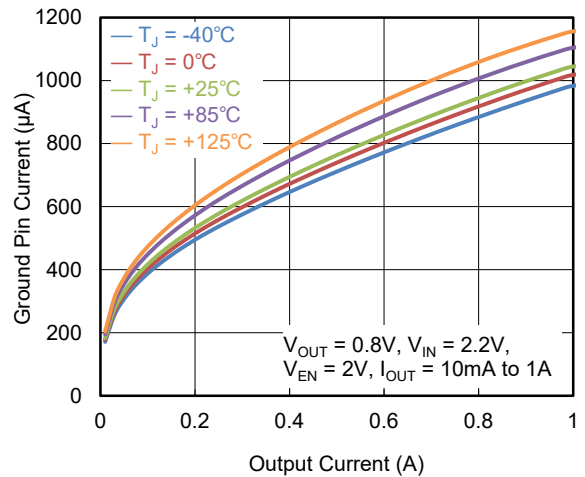

TYPICAL PERFORMANCE CHARACTERISTICS (continued)

$T_J = +25^\circ\text{C}$ ,  $V_{IN} = (V_{OUT(NOM)} + 0.5\text{V})$  or  $2.2\text{V}$  (whichever is greater),  $V_{OUT(NOM)} = 3.3\text{V}$ ,  $V_{EN} = V_{IN}$ ,  $I_{OUT} = 100\text{mA}$ ,  $C_{IN} = C_{OUT} = 4.7\mu\text{F}$ ,  $C_{NR} = 10\text{nF}$ , unless otherwise noted.

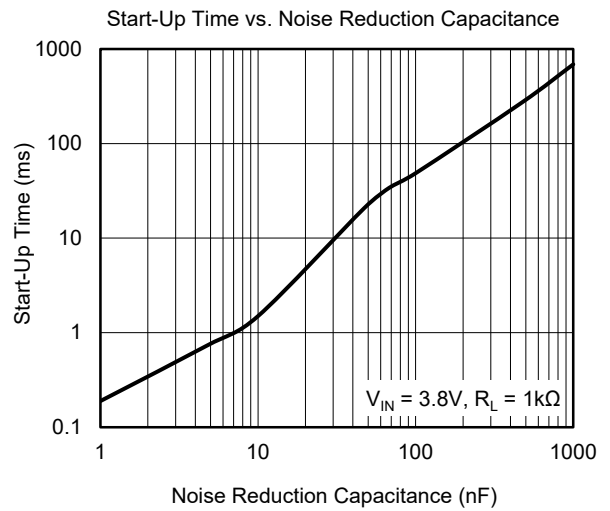
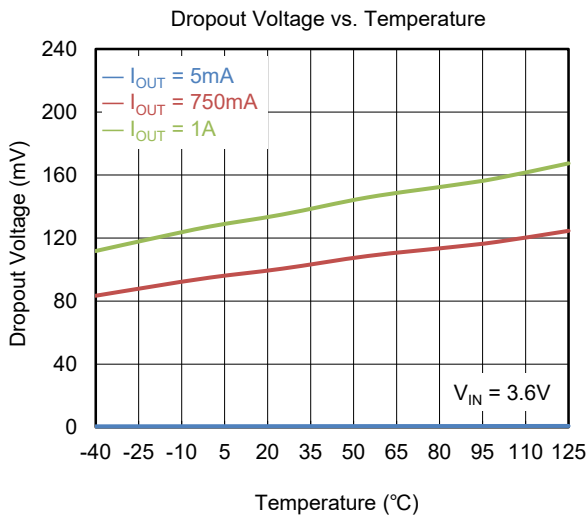
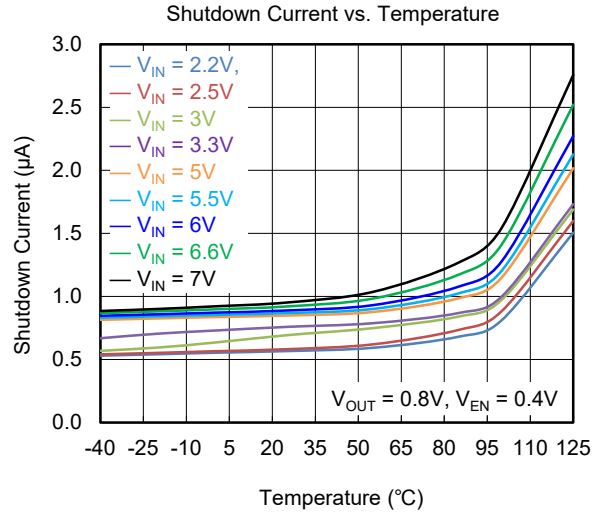
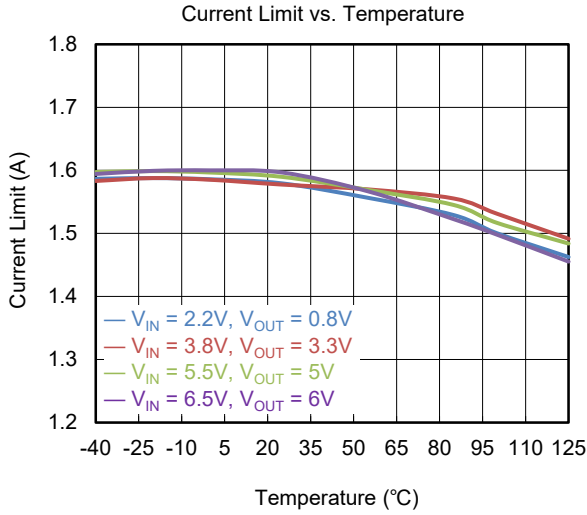

**FUNCTIONAL BLOCK DIAGRAMS**

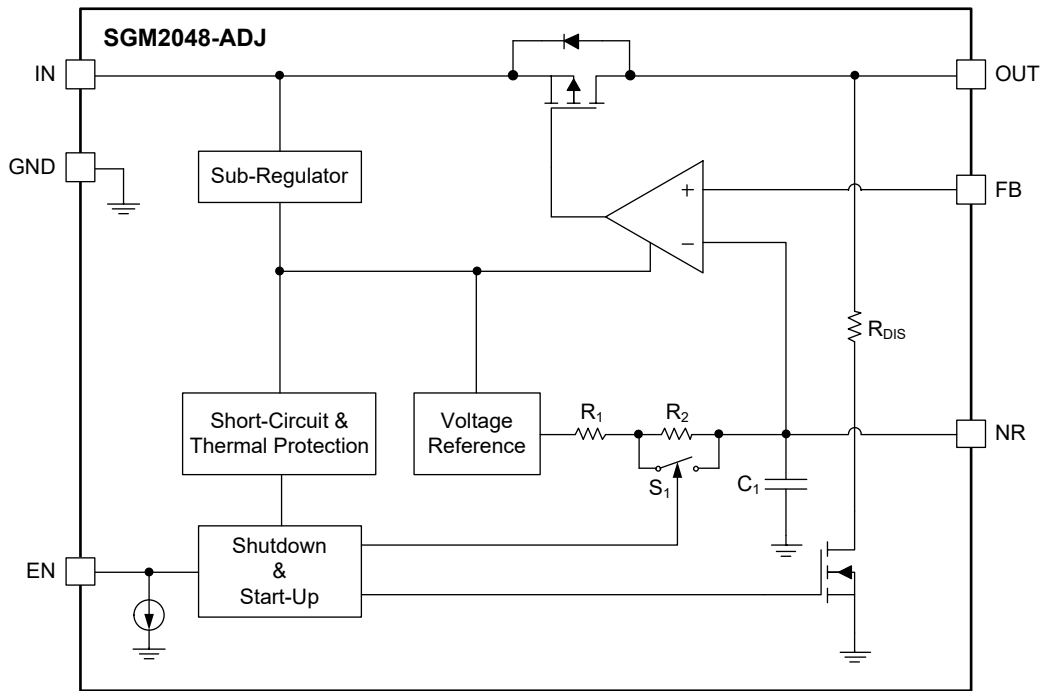

**Figure 2. Adjustable Output Voltage Internal Block Diagram**

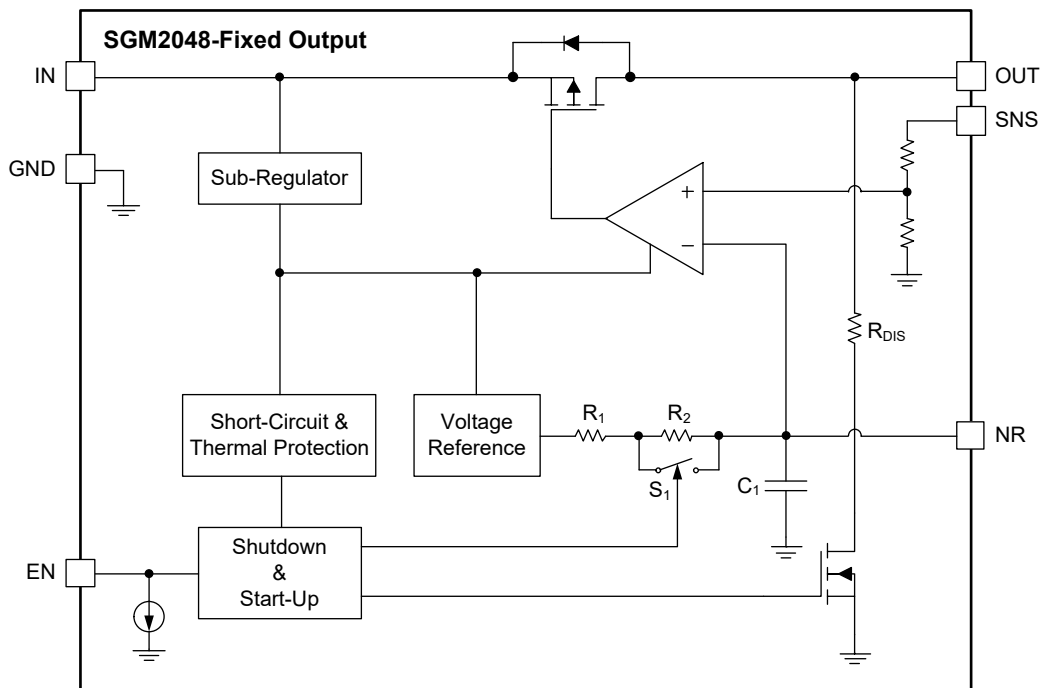

**Figure 3. Fixed Output Voltage Internal Block Diagram**

## APPLICATION INFORMATION

The SGM2048 is a low noise, high PSRR and fast transient response LDO and provides 1A output current. These features make the device a reliable solution to solve many challenging problems in the generation of clean and accurate power supply. The high performance also makes the SGM2048 useful in a variety of applications. The SGM2048 provides the protection function for output overload, output short-circuit condition and overheating.

The SGM2048 provides an EN pin as an external chip enable control to enable/disable the device. When the regulator is in shutdown state, the shutdown current consumes as low as 1 $\mu$ A (TYP).

### Input Capacitor Selection ( $C_{IN}$ )

The input decoupling capacitor should be placed as close as possible to the IN pin for ensuring the device stability. 10 $\mu$ F or larger X7R or X5R ceramic capacitor is selected to get good dynamic performance.

When  $V_{IN}$  is required to provide large current instantaneously, a large effective input capacitor is required. Multiple input capacitors can limit the input tracking inductance. Adding more input capacitors is available to restrict the ringing and keep it below the device absolute maximum ratings.

### Output Capacitor Selection ( $C_{OUT}$ )

The output decoupling capacitor should be placed as close as possible to the OUT pin. 10 $\mu$ F or larger X7R or X5R ceramic capacitor is selected to get good dynamic performance. The minimum effective capacitance of  $C_{OUT}$  that SGM2048 can remain stable is 4.7 $\mu$ F. For ceramic capacitor, temperature, DC bias and package size will change the effective capacitance, so enough margin of  $C_{OUT}$  must be considered in design. Additionally,  $C_{OUT}$  with larger capacitance and lower ESR will help increase the high frequency PSRR and improve the load transient response.

### Noise-Reduction Capacitor ( $C_{NR}$ )

A 10nF  $C_{NR}$  is used to minimize the noise of LDO in application.  $V_{REF}$ , output resistor divider and error amplifier are the dominant noise source of LDO in application, but for the SGM2048, the  $V_{REF}$  does not contribute significantly to noise due to noise-reduction capacitor  $C_{NR}$ . On the contrary, the dominant noise sources are the output resistor divider and the error amplifier.

### Dropout Voltage and $V_{IN}$

The SGM2048 features low dropout voltage due to low  $R_{DS(ON)}$  PMOSFET power transistor. For Linear regulator, when  $(V_{IN} - V_{OUT}) < \text{dropout voltage } (V_{DROPP})$ , the PMOSFET power transistor will be turned on like a switch, the parameter of linear regulator, such as PSRR, load and input transient responses, will be degraded so much. To get good performance in application, the  $V_{IN}$  must be larger than  $(V_{OUT} + V_{DROPP})$ .

### Adjustable Regulator

The output voltage of the SGM2048-ADJ can be adjusted from 0.8V to 6V. The FB pin will be connected to two external resistors as shown in Figure 4. The output voltage is determined by the following equation:

$$V_{OUT} = V_{FB} \times \left( 1 + \frac{R_1}{R_2} \right) \quad (1)$$

where:

$V_{OUT}$  is output voltage and  $V_{FB}$  is the internal voltage reference,  $V_{FB} = 0.8V$ .

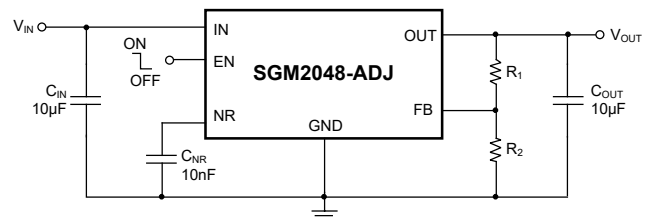

Figure 4. Adjustable Output Voltage Application

$R_1$  and  $R_2$  can be calculated for any output voltage range using Equation 1. Choose  $R_2 = 10k\Omega$  to maintain an 80 $\mu$ A minimum load.

### Enable Control

The EN pin of the SGM2048 is used to enable/disable the device and to deactivate/activate the output automatic discharge function.

When the EN pin voltage is lower than  $V_{EN(L)}$ , the device is in shutdown state, there is no current flowing from IN to OUT pins. In this state, the automatic discharge transistor is active to discharge the output voltage through a 105 $\Omega$  (TYP) resistor.

When the EN pin voltage is higher than  $V_{EN(H)}$ , the device is in active state, the input voltage is regulated to the output voltage and the automatic discharge transistor is turned off.

## APPLICATION INFORMATION (continued)

### Start-Up

In Figure 2 and Figure 3, a low-pass (RC) filter is used to reduce the noise of bandgap voltage reference, the external  $C_{NR}$  and the resistance controlled by the quick-start circuit consists of this filter. The switch for quick-start is closed at start-up,  $C_{NR}$  will be charged by  $V_{REF}$  circuit and there is only 33k $\Omega$  resistance between bandgap circuit output and the NR pin. It's about 2ms after the device is enabled that the switch for quick-start will be turned off, the resistance between the NR pin and bandgap circuit output will be changed to about 265k $\Omega$ . This low-pass filter helps LDO achieve very good noise-reduction after start-up due to resistance is changed from 33k $\Omega$  to 265k $\Omega$ . Generally, low leakage ceramic capacitor is used and the value of  $C_{NR}$  is larger than 10nF. Larger  $C_{NR}$  is better to reduce the noise of LDO, but it prolongs the start-up time of LDO, the value of  $C_{NR}$  must be the trade-off between noise and start-up time.

### Under-Voltage Lockout (UVLO)

The UVLO circuit monitors the input voltage to prevent the device from turning on before  $V_{IN}$  rises above the  $V_{UVLO}$  threshold. The UVLO circuit responds quickly to glitches on the IN pin and attempts to disable the output of the device if any of these rails collapses. The local input capacitance prevents severe brownouts in most applications.

### Minimum Load

The SGM2048 fixed voltage versions can remain stable when there is no output load.

### Input Power Supply

The input power supply range is from 2.2V to 7V.  $V_{IN}$  must be larger than  $(V_{OUT} + V_{DROP})$  in application. The input ceramic capacitor must be placed as close as possible to the IN pin, this  $C_{IN}$  can help improve the output noise performance of LDO.

### Reverse Current Protection

The pass transistor has an inherent body diode which will be forward biased in the case when  $V_{OUT} > (V_{IN} + 0.3V)$ . If extended reverse voltage operation is anticipated, external limiting might be appropriate.

### Negatively Biased Output

When the output voltage is negative, the chip may not start up due to parasitic effects. Ensure that the output is greater than -0.3V under all conditions. If negatively

biased output is excessive and expected in the application, a Schottky diode can be added between the OUT pin and GND pin.

### Output Current Limit and Short-Circuit Protection

When overload events happen, the output current is internally limited to 1.6A (TYP). When the OUT pin is shorted to ground, the short-circuit protection will limit the output current to 1.6A (TYP).

### Thermal Shutdown

The SGM2048 can detect the temperature of die. When the die temperature exceeds the threshold value of thermal shutdown, the SGM2048 will be in shutdown state and remain in this state until the die temperature decreases to +150°C.

### Power Dissipation ( $P_D$ )

Thermal protection limits power dissipation in the SGM2048. When power dissipation on pass element ( $P_D = (V_{IN} - V_{OUT}) \times I_{OUT}$ ) is too much that raise the operation junction temperature exceeds +170°C, the OTP circuit starts the thermal shutdown function and turns the pass element off.

Therefore, thermal analysis for the chosen application is important to guarantee reliable performance over all conditions. To guarantee reliable operation, the junction temperature of the SGM2048 must not exceed +125°C.

The maximum allowable power dissipation depends on the thermal resistance of the IC package, the PCB layout, the rate of surrounding airflow, and the difference between the junction temperature and ambient temperature. The maximum power dissipation can be approximated using the following equation:

$$P_{D(MAX)} = (T_{J(MAX)} - T_A) / \theta_{JA} \quad (2)$$

where  $T_{J(MAX)}$  is the maximum junction temperature,  $T_A$  is the ambient temperature, and  $\theta_{JA}$  is the junction-to-ambient thermal resistance.

### Layout Guidelines

To get good PSRR, low output noise and high transient response performance, the input and output bypass capacitors must be placed as close as possible to the IN pin and OUT pin separately.  $V_{IN}$  and  $V_{OUT}$  had better use separate ground planes and these ground planes are single point connected to the GND pin.

**REVISION HISTORY**

NOTE: Page numbers for previous revisions may differ from page numbers in the current version.

| <b>MAY 2022 – REV.A to REV.A.1</b>           | <b>Page</b> |
|--|-------------|
| Updated Application Information section..... | 13          |

---

| <b>Changes from Original (JANUARY 2022) to REV.A</b>  | <b>Page</b> |
|---|-------------|
| Changed from product preview to production data ..... | All         |

---

# PACKAGE INFORMATION

## PACKAGE OUTLINE DIMENSIONS

### TDFN-3x3-8CL

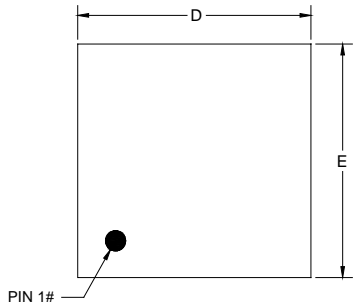

TOP VIEW

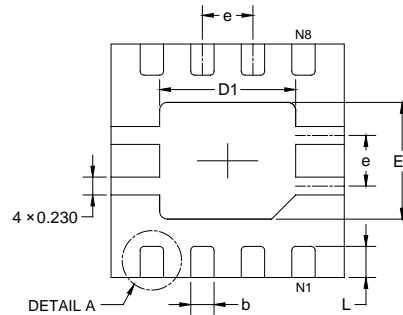

BOTTOM VIEW

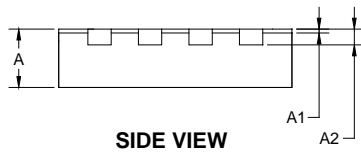

SIDE VIEW

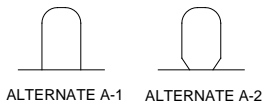

DETAIL A  
ALTERNATE TERMINAL  
CONSTRUCTION

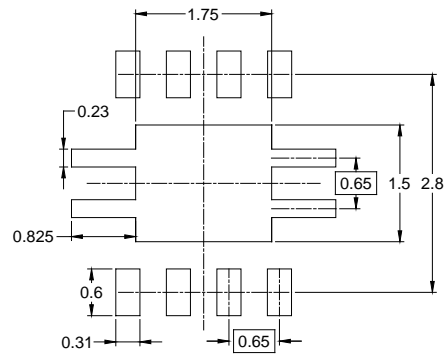

RECOMMENDED LAND PATTERN (Unit: mm)

| Symbol | Dimensions In Millimeters |       |       |
|--------|---------------------------|-------|-------|
|        | MIN                       | MOD   | MAX   |
| A      | 0.700                     | 0.750 | 0.800 |
| A1     | -                         | -     | 0.050 |
| A2     | 0.203 REF                 |       |       |
| D      | 2.950                     | 3.000 | 3.050 |
| D1     | 1.700                     | 1.750 | 1.800 |
| E      | 2.950                     | 3.000 | 3.050 |
| E1     | 1.450                     | 1.500 | 1.550 |
| b      | 0.250                     | 0.300 | 0.350 |
| e      | 0.650 BSC                 |       |       |
| L      | 0.350                     | 0.400 | 0.450 |

NOTE: This drawing is subject to change without notice.

# PACKAGE INFORMATION

## TAPE AND REEL INFORMATION

### REEL DIMENSIONS



### TAPE DIMENSIONS



NOTE: The picture is only for reference. Please make the object as the standard.

### KEY PARAMETER LIST OF TAPE AND REEL

| Package Type | Reel Diameter | Reel Width W1 (mm) | A0 (mm) | B0 (mm) | K0 (mm) | P0 (mm) | P1 (mm) | P2 (mm) | W (mm) | Pin1 Quadrant |
|--------------|---------------|--------------------|---------|---------|---------|---------|---------|---------|--------|---------------|
| TDFN-3×3-8CL | 13"           | 12.4               | 3.30    | 3.30    | 1.10    | 4.0     | 8.0     | 2.0     | 12.0   | Q2            |

DD0001



# PACKAGE INFORMATION

## CARTON BOX DIMENSIONS



NOTE: The picture is only for reference. Please make the object as the standard.

## KEY PARAMETER LIST OF CARTON BOX

| Reel Type | Length (mm) | Width (mm) | Height (mm) | Pizza/Carton |
|-----------|-------------|------------|-------------|--------------|
| 13"       | 386         | 280        | 370         | 5            |

DD0002