

GENERAL DESCRIPTION

The SGM2211 is a low noise, high PSRR, fast transient response, and low dropout voltage linear regulator which is designed using CMOS technology. It provides 500mA output current capability. The operating input voltage range is from 2.7V to 20V. The adjustable output voltage range is from 1.2V to $(V_{IN} - V_{DROP})$.

Other features include logic-controlled shutdown mode, short-circuit current limit and thermal shutdown protection. The SGM2211 has automatic discharge function to quickly discharge V_{OUT} in the disabled status.

The SGM2211 is available in Green TDFN-2x2-6AL and SOT-23-5 packages. It operates over an operating temperature range of -40°C to $+125^{\circ}\text{C}$.

APPLICATIONS

Instrumentation
Precision ADC and DAC
Precision Amplifiers in Industrial Equipment
Low Noise VCO
RF System
Medical Equipment

FEATURES

- **Input Voltage Range: 2.7V to 20V**
- **Output Voltage Accuracy: $\pm 1\%$ at $+25^{\circ}\text{C}$**
- **Adjustable Output Voltages: 1.2V to $(V_{IN} - V_{DROP})$**
- **Low Noise:**
 - ◆ **$9.3\mu\text{V}_{\text{RMS}}$ at $V_{OUT} = 1.2\text{V}$**
 - ◆ **$11\mu\text{V}_{\text{RMS}}$ at $V_{OUT} = 2.8\text{V}$**
 - ◆ **$14\mu\text{V}_{\text{RMS}}$ at $V_{OUT} = 5.0\text{V}$**
- **PSRR ($V_{IN} = V_{OUT(\text{NOM})} + 1\text{V}$):**
 - ◆ **100dB at 1kHz**
 - ◆ **83dB at 10kHz**
 - ◆ **52dB at 100kHz**
 - ◆ **55dB at 1MHz**
- **Low Dropout Voltage:**
360mV (TYP) at 500mA Load when $V_{OUT} = 5.0\text{V}$
- **Low Quiescent Current: 39 μA (TYP)**
- **Shutdown Current: 1.2 μA (TYP)**
- **Stable with a 2.2 μF Ceramic Output Capacitor**
- **Reverse Current Protection when $V_{OUT} > V_{IN}$**
- **Foldback Current-Limit Protection when V_{OUT} is Shorted to GND**
- **Automatic V_{OUT} Discharge when Disabled**
- **Programmable Precision Enable**
- **Programmable Soft-Start (TDFN Package Only)**
- **-40°C to $+125^{\circ}\text{C}$ Operating Temperature Range**
- **Available in Green TDFN-2x2-6AL and SOT-23-5 Packages**

PACKAGE/ORDERING INFORMATION

MODEL	PACKAGE DESCRIPTION	SPECIFIED TEMPERATURE RANGE	ORDERING NUMBER	PACKAGE MARKING	PACKING OPTION
SGM2211-1.2	TDFN-2x2-6AL	-40°C to +125°C	SGM2211-1.2XTDI6G/TR	C1B XXXX	Tape and Reel, 3000
SGM2211-1.5	TDFN-2x2-6AL	-40°C to +125°C	SGM2211-1.5XTDI6G/TR	C1C XXXX	Tape and Reel, 3000
SGM2211-1.8	TDFN-2x2-6AL	-40°C to +125°C	SGM2211-1.8XTDI6G/TR	C1D XXXX	Tape and Reel, 3000
SGM2211-2.5	TDFN-2x2-6AL	-40°C to +125°C	SGM2211-2.5XTDI6G/TR	C1E XXXX	Tape and Reel, 3000
SGM2211-2.8	TDFN-2x2-6AL	-40°C to +125°C	SGM2211-2.8XTDI6G/TR	C1F XXXX	Tape and Reel, 3000
SGM2211-3.0	TDFN-2x2-6AL	-40°C to +125°C	SGM2211-3.0XTDI6G/TR	C20 XXXX	Tape and Reel, 3000
SGM2211-3.3	TDFN-2x2-6AL	-40°C to +125°C	SGM2211-3.3XTDI6G/TR	C21 XXXX	Tape and Reel, 3000
SGM2211-3.8	TDFN-2x2-6AL	-40°C to +125°C	SGM2211-3.8XTDI6G/TR	C22 XXXX	Tape and Reel, 3000
SGM2211-4.2	TDFN-2x2-6AL	-40°C to +125°C	SGM2211-4.2XTDI6G/TR	C23 XXXX	Tape and Reel, 3000
SGM2211-5.0	TDFN-2x2-6AL	-40°C to +125°C	SGM2211-5.0XTDI6G/TR	C24 XXXX	Tape and Reel, 3000
SGM2211-1.2	SOT-23-5	-40°C to +125°C	SGM2211-1.2XN5G/TR	C11XX	Tape and Reel, 3000
SGM2211-1.5	SOT-23-5	-40°C to +125°C	SGM2211-1.5XN5G/TR	C12XX	Tape and Reel, 3000
SGM2211-1.8	SOT-23-5	-40°C to +125°C	SGM2211-1.8XN5G/TR	C13XX	Tape and Reel, 3000
SGM2211-2.5	SOT-23-5	-40°C to +125°C	SGM2211-2.5XN5G/TR	C14XX	Tape and Reel, 3000
SGM2211-2.8	SOT-23-5	-40°C to +125°C	SGM2211-2.8XN5G/TR	C15XX	Tape and Reel, 3000
SGM2211-3.0	SOT-23-5	-40°C to +125°C	SGM2211-3.0XN5G/TR	C16XX	Tape and Reel, 3000
SGM2211-3.3	SOT-23-5	-40°C to +125°C	SGM2211-3.3XN5G/TR	C17XX	Tape and Reel, 3000
SGM2211-3.8	SOT-23-5	-40°C to +125°C	SGM2211-3.8XN5G/TR	C18XX	Tape and Reel, 3000
SGM2211-4.2	SOT-23-5	-40°C to +125°C	SGM2211-4.2XN5G/TR	C19XX	Tape and Reel, 3000
SGM2211-5.0	SOT-23-5	-40°C to +125°C	SGM2211-5.0XN5G/TR	C1AXX	Tape and Reel, 3000
SGM2211-ADJ	SOT-23-5	-40°C to +125°C	SGM2211-ADJXN5G/TR	C2FXX	Tape and Reel, 3000

MARKING INFORMATION

NOTE: XX = Date Code. XXXX = Date Code and Trace Code.

TDFN-2x2-6AL

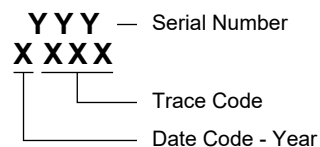

SOT-23-5

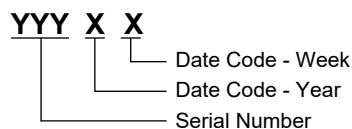

Green (RoHS & HSF): SG Micro Corp defines "Green" to mean Pb-Free (RoHS compatible) and free of halogen substances. If you have additional comments or questions, please contact your SGMICRO representative directly.

ABSOLUTE MAXIMUM RATINGS

VIN to GND	-0.3V to 24V
VOUT to GND	-0.3V to 24V
EN to GND	-0.3V to 24V
SENSE/ADJ to GND	-0.3V to 24V
SS to GND	-0.3V to VIN or 6V (whichever is less)
Package Thermal Resistance	
TDFN-2×2-6AL, θ_{JA}	100°C/W
TDFN-2×2-6AL, θ_{JB}	37°C/W
TDFN-2×2-6AL, θ_{JC}	77°C/W
SOT-23-5, θ_{JA}	182°C/W
SOT-23-5, θ_{JB}	44°C/W
SOT-23-5, θ_{JC}	70°C/W
Junction Temperature	+150°C
Storage Temperature Range	-65°C to +150°C
Lead Temperature (Soldering, 10s)	+260°C
ESD Susceptibility	
HBM	8000V
CDM	1000V

RECOMMENDED OPERATING CONDITIONS

Input Voltage Range	2.7V to 20V
Input Effective Capacitance, C_{IN}	1.5 μ F (MIN)
Output Effective Capacitance, C_{OUT}	1.5 μ F to 10 μ F
Operating Junction Temperature Range	-40°C to +125°C

OVERSTRESS CAUTION

Stresses beyond those listed in Absolute Maximum Ratings may cause permanent damage to the device. Exposure to absolute maximum rating conditions for extended periods may affect reliability. Functional operation of the device at any conditions beyond those indicated in the Recommended Operating Conditions section is not implied.

ESD SENSITIVITY CAUTION

This integrated circuit can be damaged if ESD protections are not considered carefully. SGMICRO recommends that all integrated circuits be handled with appropriate precautions. Failure to observe proper handling and installation procedures can cause damage. ESD damage can range from subtle performance degradation to complete device failure. Precision integrated circuits may be more susceptible to damage because even small parametric changes could cause the device not to meet the published specifications.

DISCLAIMER

SG Micro Corp reserves the right to make any change in circuit design, or specifications without prior notice.

PIN CONFIGURATIONS

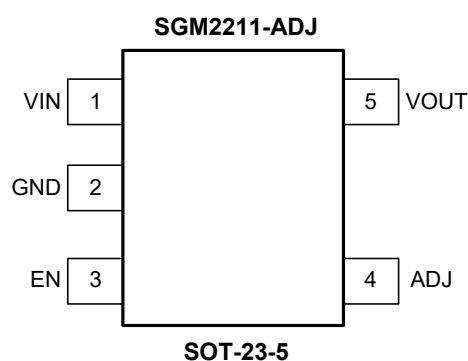
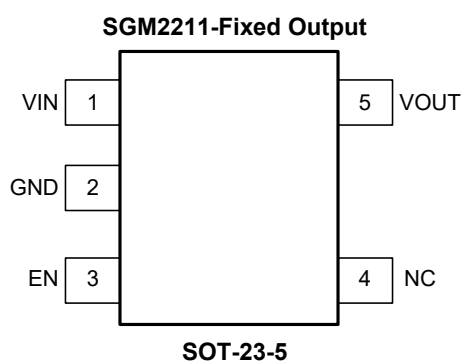
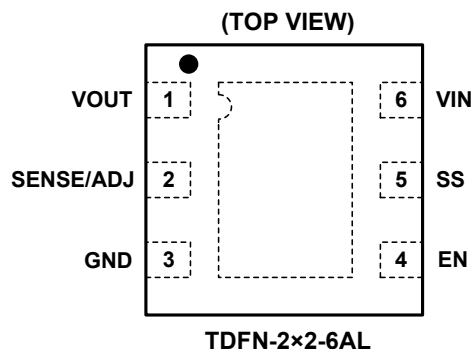

PIN DESCRIPTION

PIN		NAME	FUNCTION
TDFN-2x2-6AL	SOT-23-5		
1	5	VOUT	Regulator Output Pin. It is recommended to use a ceramic capacitor with effective capacitance in the range of 1.5µF to 10µF to get good power supply decoupling. This ceramic capacitor should be placed as close as possible to VOUT pin.
2	–	SENSE/ADJ	Sense Input (SENSE). Connect to load. An external resistor divider may also set the output voltage higher than the fixed output voltage (ADJ).
3	2	GND	Ground.
4	3	EN	Enable Pin. Drive EN high to turn on the regulator. Drive EN low to turn off the regulator.
5	–	SS	Soft-Start Pin. The soft-start time is determined by an external capacitor connected to this pin.
6	1	VIN	Input Voltage Supply Pin. It is recommended to use a ceramic capacitor with a minimum effective capacitance of 1.5µF from VIN pin to ground.
–	4	NC	Not Connected (fixed voltage version only).
–		ADJ	Feedback Input Pin (adjustable voltage version only). Connect this pin to the external resistor divider to adjust the output voltage. Place the resistors as close as possible to this pin.
Exposed Pad	–	–	Exposed Pad. Connect it to a large ground plane to maximize thermal performance; this pad is not an electrical connection point.

ELECTRICAL CHARACTERISTICS

($V_{IN} = (V_{OUT(NOM)} + 1V)$ or 2.7V (whichever is greater), $V_{EN} = V_{IN}$, $I_{OUT} = 10mA$, $C_{IN} = C_{OUT} = 2.2\mu F$ and $C_{SS} = 0nF$, $T_J = -40^\circ C$ to $+125^\circ C$, typical values are at $T_J = +25^\circ C$, unless otherwise noted.)

PARAMETER	SYMBOL	CONDITIONS	MIN	TYP	MAX	UNITS
Input Voltage Range	V_{IN}		2.7		20	V
Under-Voltage Lockout Thresholds	V_{UVLO}	V_{IN} rising		2.52	2.70	V
		V_{IN} falling	2.16	2.33		
Operating Supply Current	I_{GND}	$I_{OUT} = 0\mu A$		39	62	μA
		$I_{OUT} = 500mA$		980	1200	
Shutdown Current	I_{SHDN}	$V_{EN} = GND$		1.2	2.2	μA
		$V_{EN} = GND, V_{IN} = 20V$		1.3	2.5	
ADJ Input Bias Current	I_{ADJ}	$V_{ADJ} = V_{OUT(NOM)} + 0.1V$	-6		6	nA
Output Voltage Accuracy	V_{OUT}	$V_{IN} = (V_{OUT(NOM)} + 1V)$ to 20V, $I_{OUT} = 100\mu A$ to 500mA, $T_J = +25^\circ C$	-1		1	%
		$V_{IN} = (V_{OUT(NOM)} + 1V)$ to 20V, $I_{OUT} = 100\mu A$ to 500mA, $T_J = -40^\circ C$ to $+125^\circ C$	-1.6		1.6	
Feedback Voltage	V_{ADJ}	$I_{OUT} = 10mA, T_J = +25^\circ C$	1.188	1.2	1.212	V
		$V_{IN} = (V_{OUT(NOM)} + 1V)$ to 20V, $I_{OUT} = 100\mu A$ to 500mA, $T_J = -40^\circ C$ to $+125^\circ C$	1.181		1.219	
Input Reverse Current	$I_{REV-INPUT}$	$V_{EN} = GND, V_{IN} = 0V, V_{OUT} = 20V$		0.05	1	μA
Line Regulation	$\frac{\Delta V_{OUT}}{\Delta V_{IN} \times V_{OUT}}$	$V_{IN} = (V_{OUT(NOM)} + 1V)$ to 20V		0.001	0.007	%/V
Load Regulation	ΔV_{OUT}	$I_{OUT} = 100\mu A$ to 500mA		3	26	mV
Dropout Voltage ⁽¹⁾	V_{DROP}	$I_{OUT} = 500mA$	$V_{OUT(NOM)} = 2.5V$	500	730	mV
			$V_{OUT(NOM)} = 3.0V$	450	680	
			$V_{OUT(NOM)} = 5.0V$	360	580	
Soft-Start Source Current	$SS_{I-SOURCE}$	$SS = GND$		1	3	μA
Output Current Limit	I_{LIMIT}	$V_{OUT} = V_{OUT(NOM)} - 1V^{(2)}$	0.51	0.80		A
Output Voltage Noise	e_n	$f = 10Hz$ to 100kHz, $I_{OUT} = 1mA$	$V_{OUT} = 1.2V$		9.3	μV_{RMS}
			$V_{OUT} = 2.8V$		11	
			$V_{OUT} = 5.0V$		14	
Power Supply Rejection Ratio	PSRR	$V_{IN} = V_{OUT(NOM)} + 1V$	$f = 1kHz$		100	dB
			$f = 10kHz$		83	
			$f = 100kHz$		52	
			$f = 1MHz$		55	
Precision EN Input	V_{IH}	Logic high, $V_{IN} = 2.7V$ to 20V	1.120	1.210	1.295	V
	V_{IL}	Logic low, $V_{IN} = 2.7V$ to 20V	1.050	1.120	1.195	
Leakage Current	I_{EN-LKG}	$V_{EN} = V_{IN}, V_{IN} = 2.7V$ to 20V		0.1	1	μA
Start-Up Time	t_{STR}	From EN rising from 0V to V_{IN} to $0.9 \times V_{OUT}, V_{OUT} = 1.2V$		150		μs
Output Discharge Resistance	R_{DIS}	$V_{EN} = 0V, V_{OUT} = 0.5V$		100	140	Ω
Thermal Shutdown Temperature	T_{SHDN}			160		$^\circ C$
Thermal Shutdown Hysteresis	ΔT_{SHDN}			20		$^\circ C$

NOTES:

- The dropout voltage is defined as the difference between V_{IN} and V_{OUT} when V_{OUT} falls to $95\% \times V_{OUT(NOM)}$.
- $V_{OUT} = V_{OUT(NOM)} - 0.2V$ when $V_{OUT} = 1.2V$.

TYPICAL PERFORMANCE CHARACTERISTICS

$T_J = +25^\circ\text{C}$, $V_{IN} = (V_{OUT(NOM)} + 1\text{V})$ or 2.7V (whichever is greater), $V_{EN} = V_{IN}$, $I_{OUT} = 10\text{mA}$, $C_{IN} = C_{OUT} = 2.2\mu\text{F}$, unless otherwise noted.

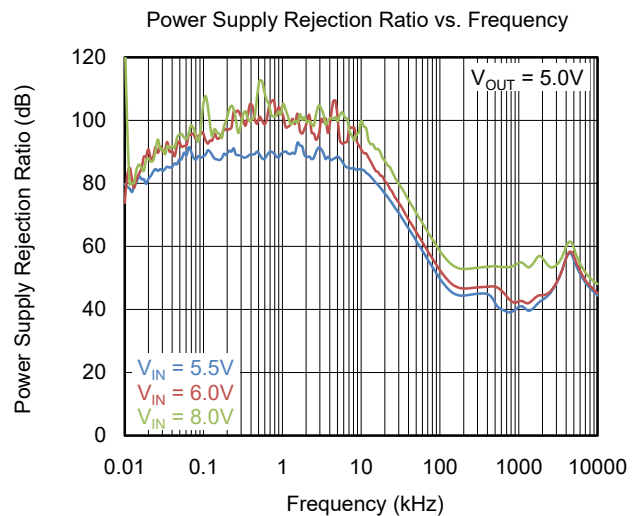
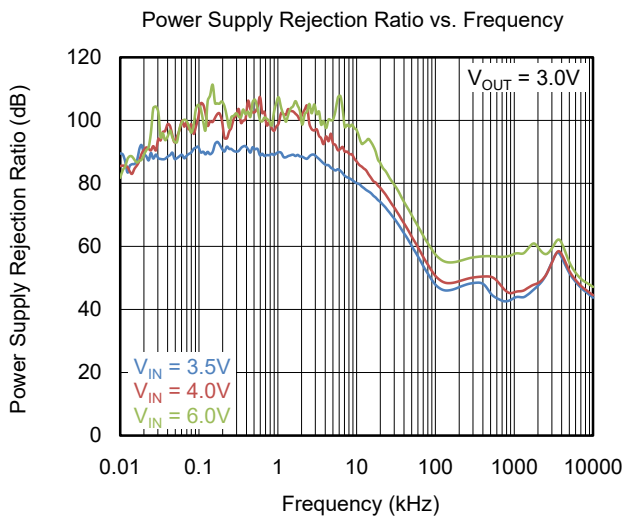
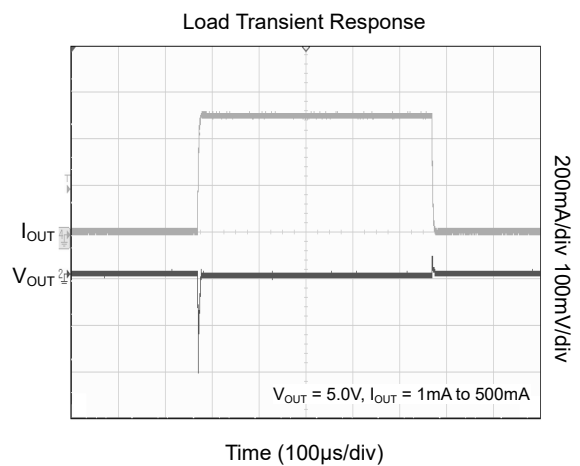
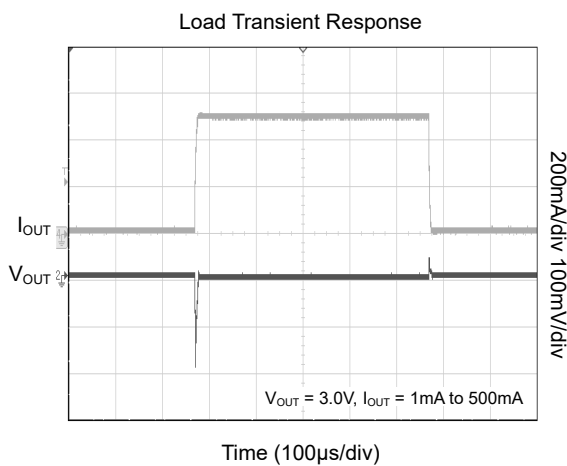
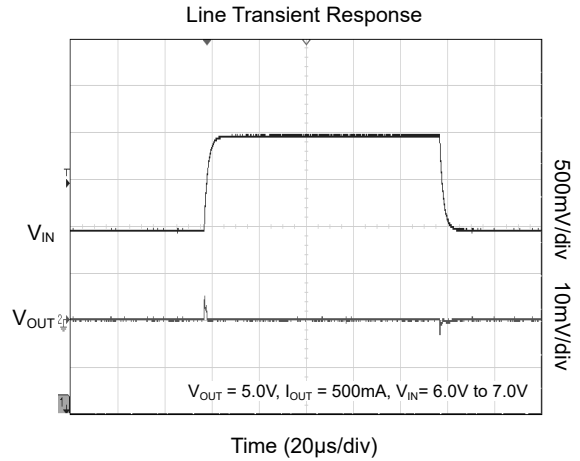
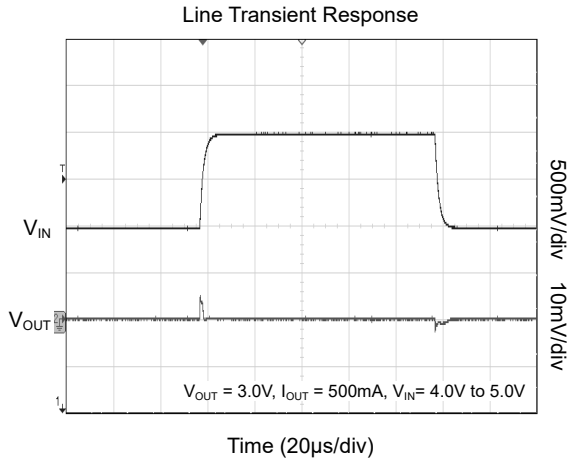

TYPICAL PERFORMANCE CHARACTERISTICS (continued)

$T_J = +25^\circ\text{C}$, $V_{IN} = (V_{OUT(NOM)} + 1V)$ or $2.7V$ (whichever is greater), $V_{EN} = V_{IN}$, $I_{OUT} = 10\text{mA}$, $C_{IN} = C_{OUT} = 2.2\mu\text{F}$, unless otherwise noted.

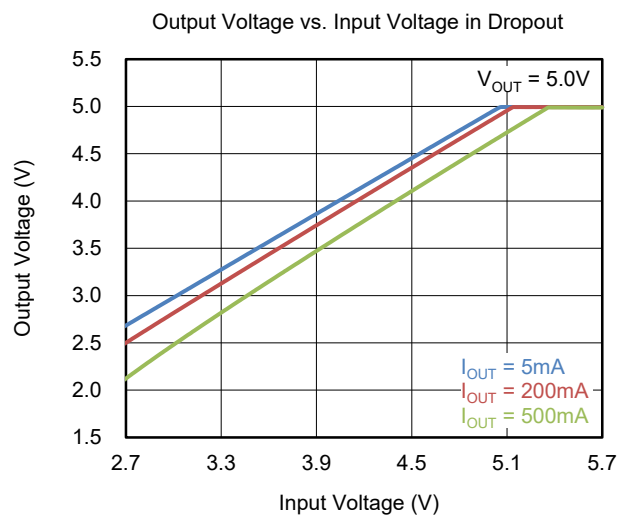
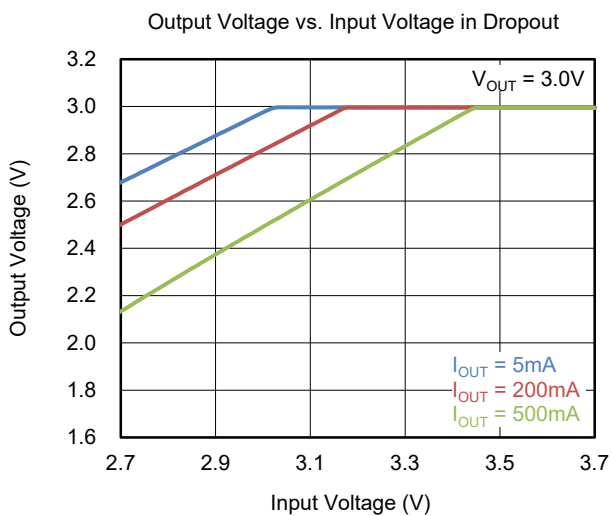
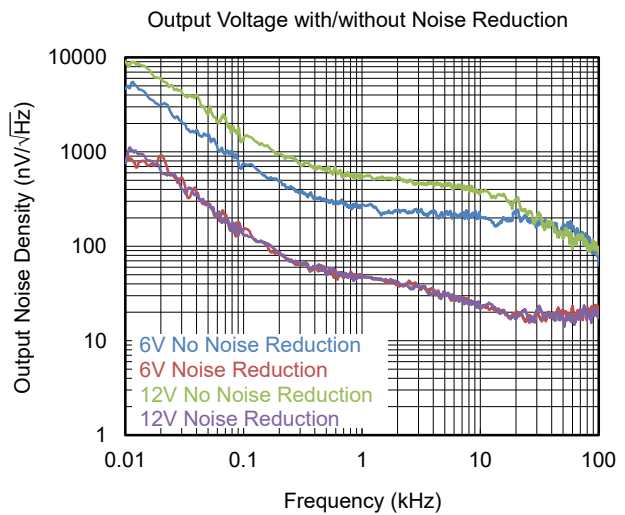
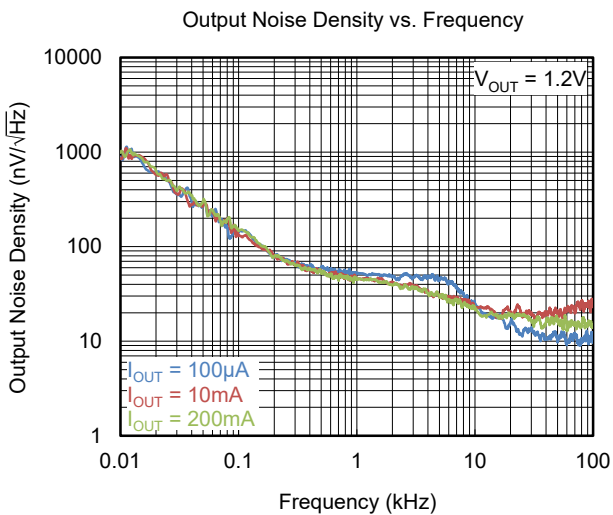
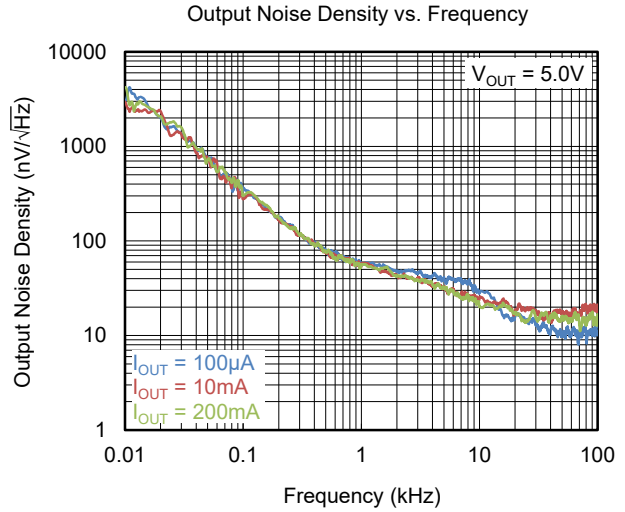
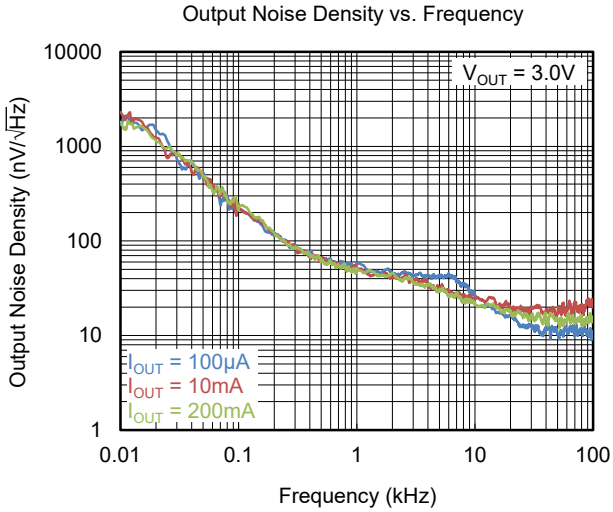

TYPICAL PERFORMANCE CHARACTERISTICS (continued)

$T_J = +25^\circ\text{C}$, $V_{IN} = (V_{OUT(NOM)} + 1\text{V})$ or 2.7V (whichever is greater), $V_{EN} = V_{IN}$, $I_{OUT} = 10\text{mA}$, $C_{IN} = C_{OUT} = 2.2\mu\text{F}$, unless otherwise noted.

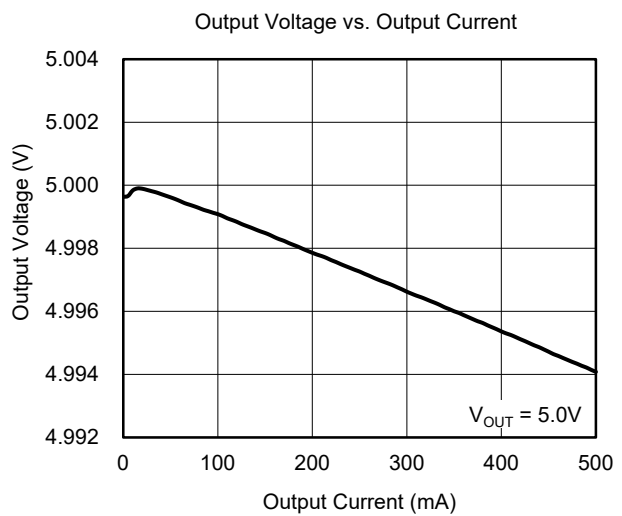
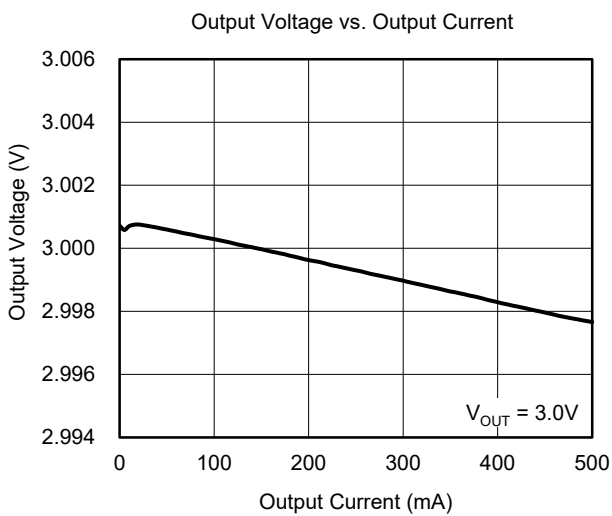
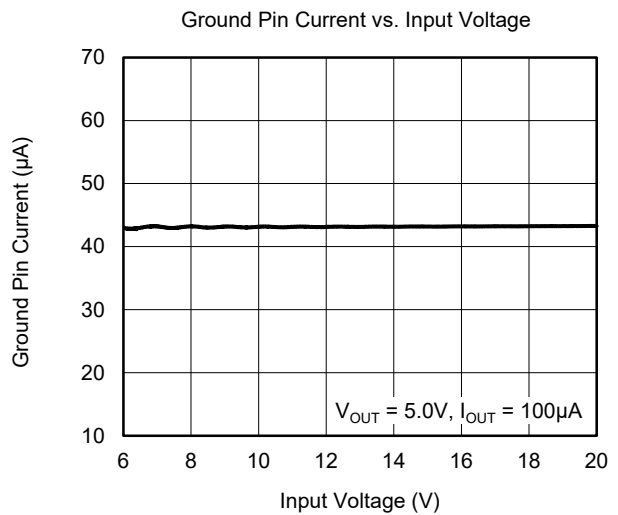
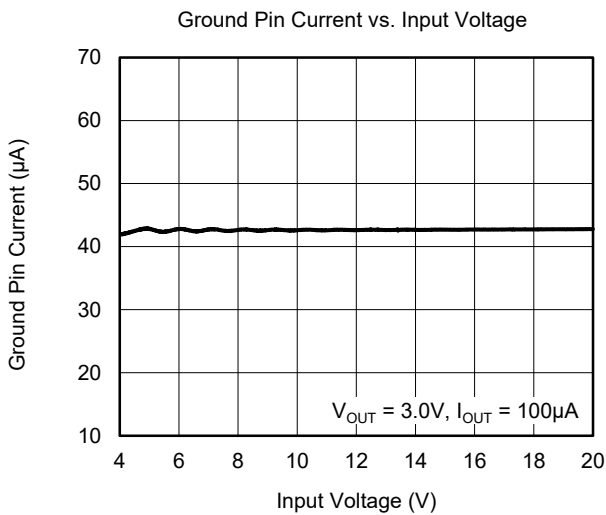
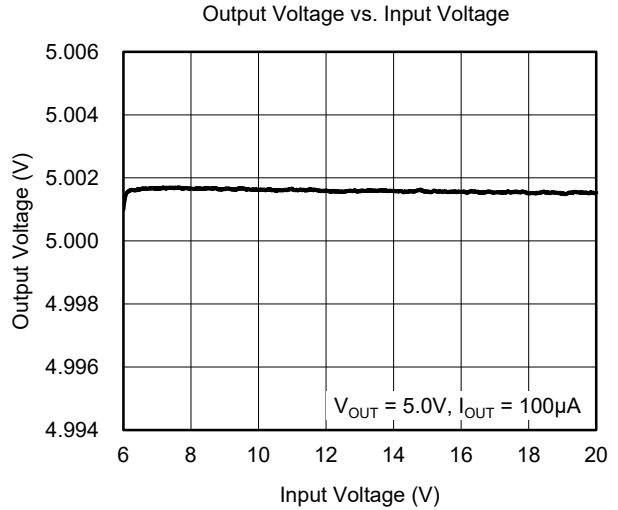
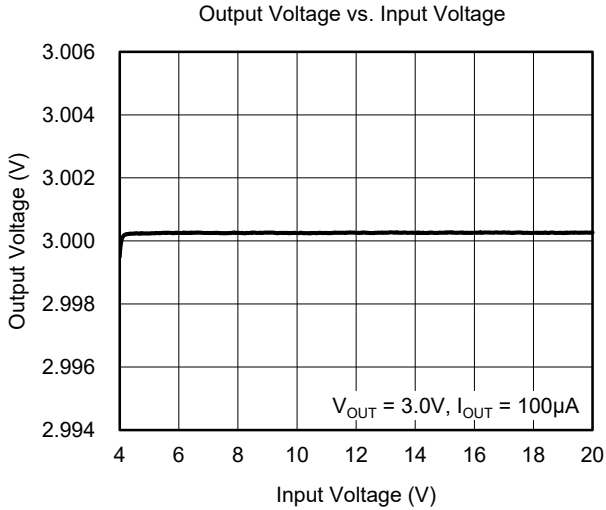

TYPICAL PERFORMANCE CHARACTERISTICS (continued)

$T_J = +25^\circ\text{C}$, $V_{IN} = (V_{OUT(NOM)} + 1V)$ or $2.7V$ (whichever is greater), $V_{EN} = V_{IN}$, $I_{OUT} = 10\text{mA}$, $C_{IN} = C_{OUT} = 2.2\mu\text{F}$, unless otherwise noted.

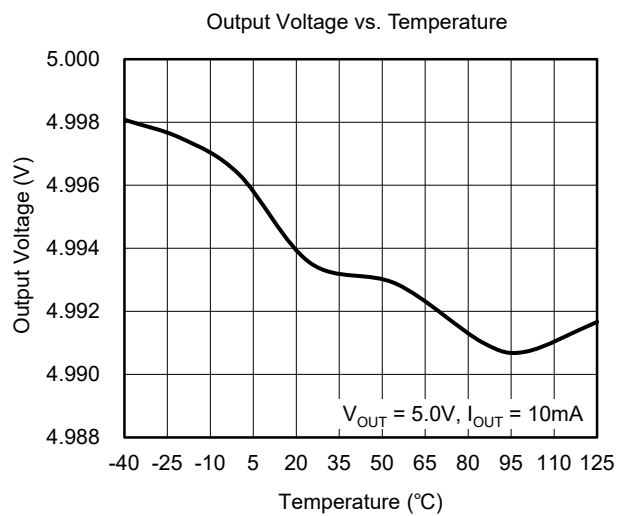
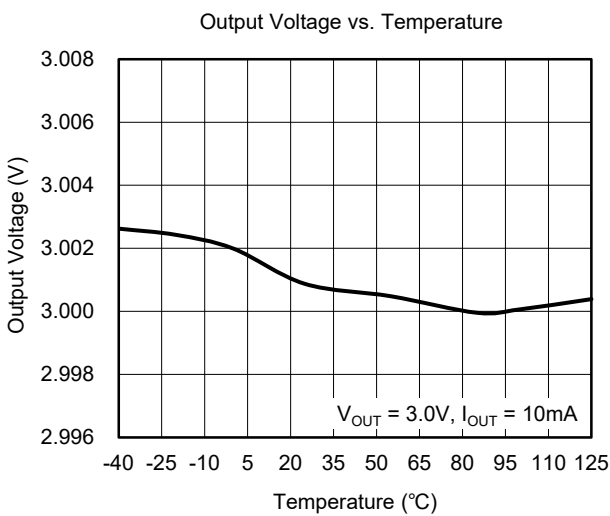
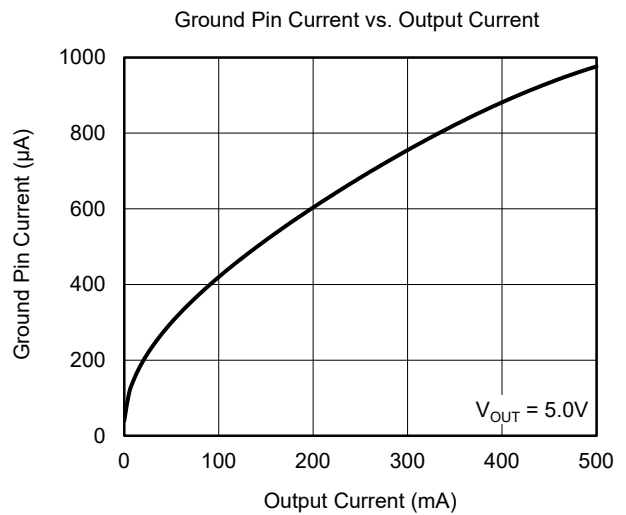
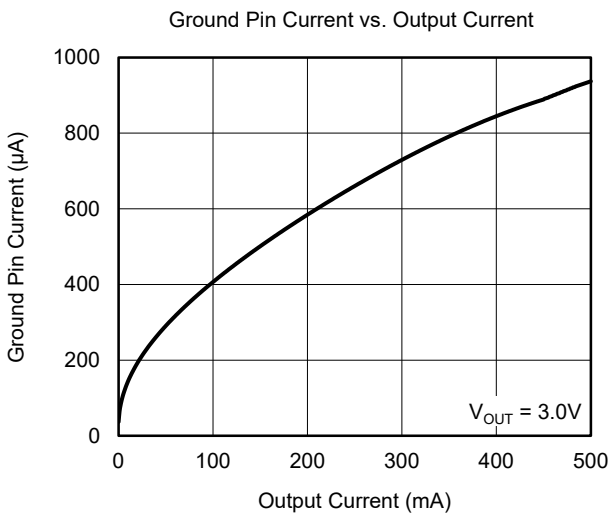
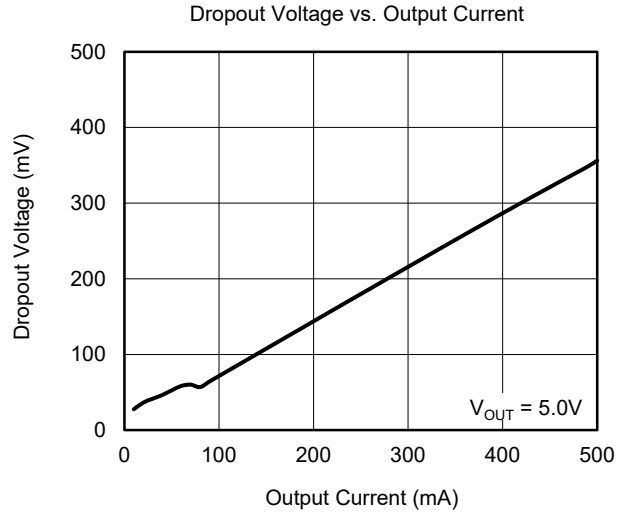
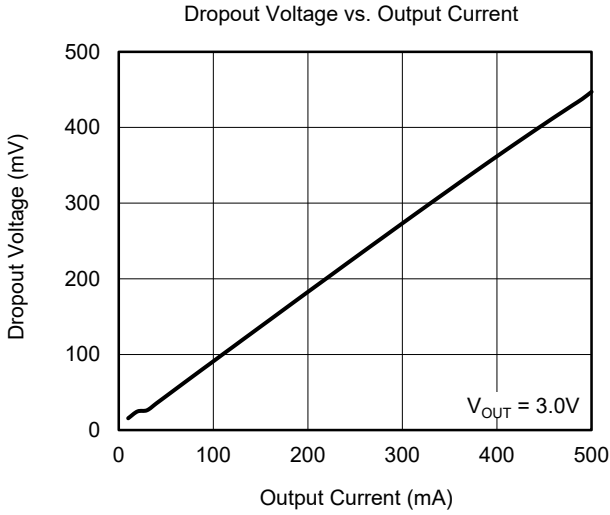

TYPICAL PERFORMANCE CHARACTERISTICS (continued)

$T_J = +25^\circ\text{C}$, $V_{IN} = (V_{OUT(NOM)} + 1V)$ or $2.7V$ (whichever is greater), $V_{EN} = V_{IN}$, $I_{OUT} = 10\text{mA}$, $C_{IN} = C_{OUT} = 2.2\mu\text{F}$, unless otherwise noted.

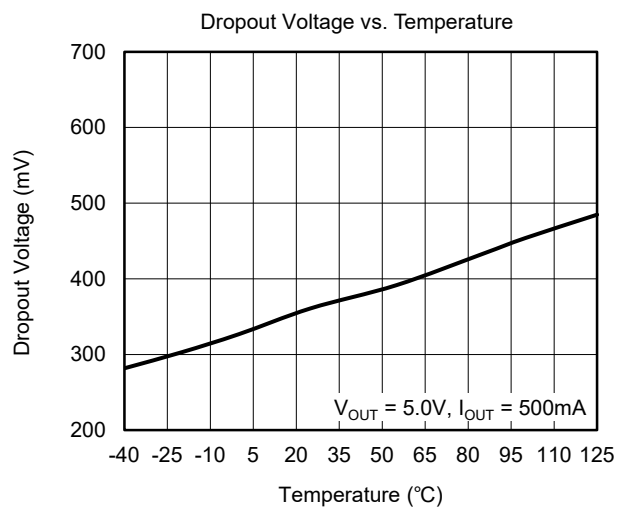
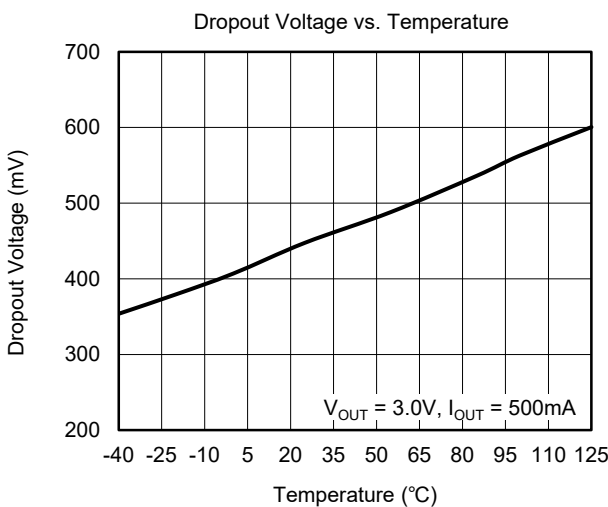
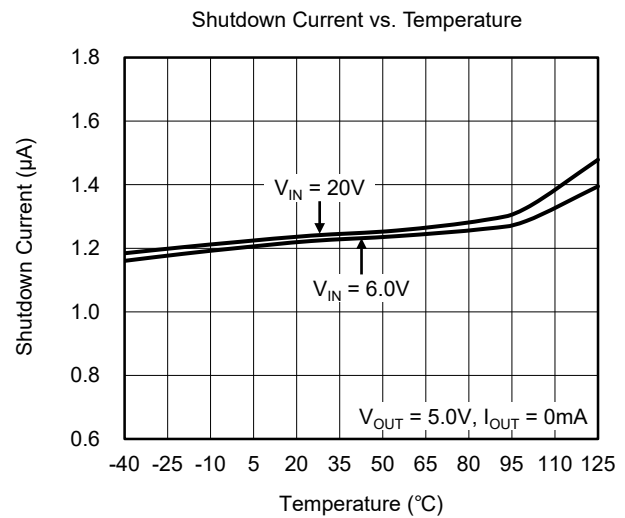
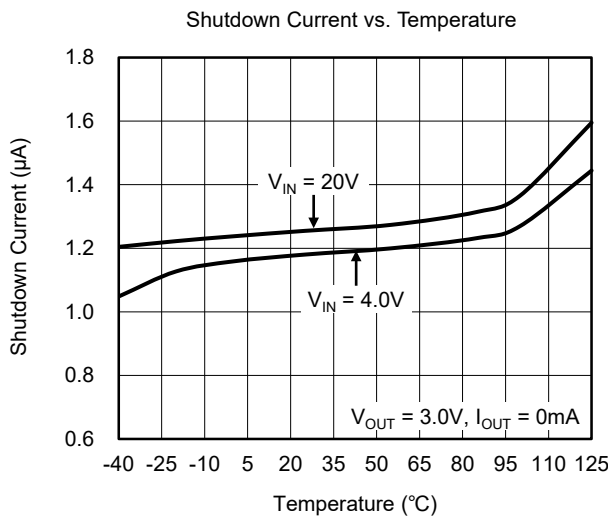
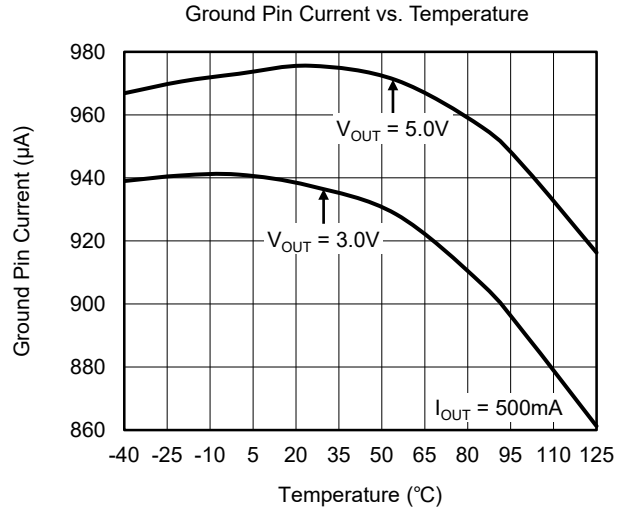
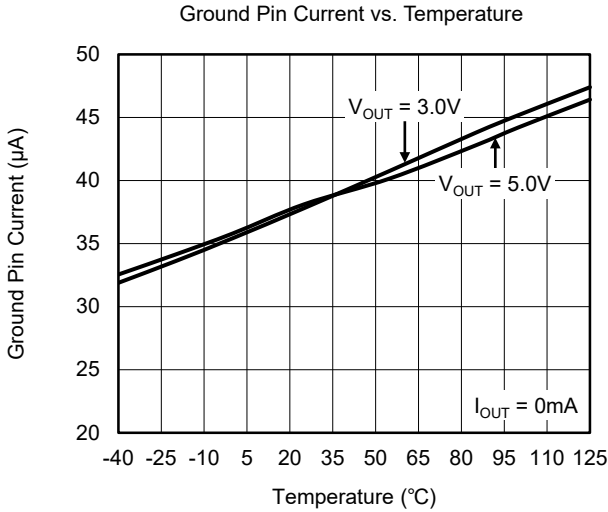

TYPICAL PERFORMANCE CHARACTERISTICS (continued)

$T_J = +25^\circ\text{C}$, $V_{IN} = (V_{OUT(NOM)} + 1\text{V})$ or 2.7V (whichever is greater), $V_{EN} = V_{IN}$, $I_{OUT} = 10\text{mA}$, $C_{IN} = C_{OUT} = 2.2\mu\text{F}$, unless otherwise noted.

Typical Start-Up Behavior

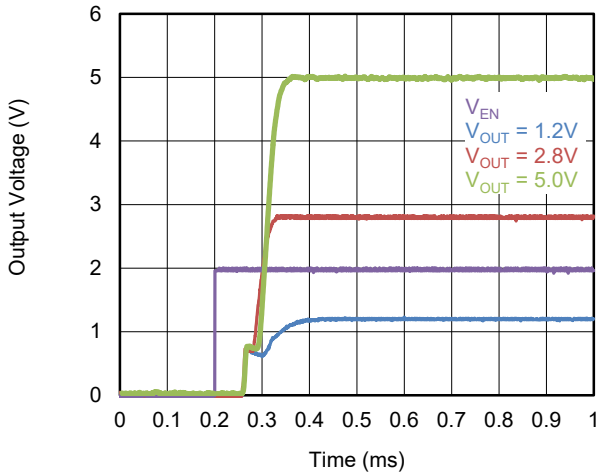

Typical Soft-Start Behavior, Different C_{SS}

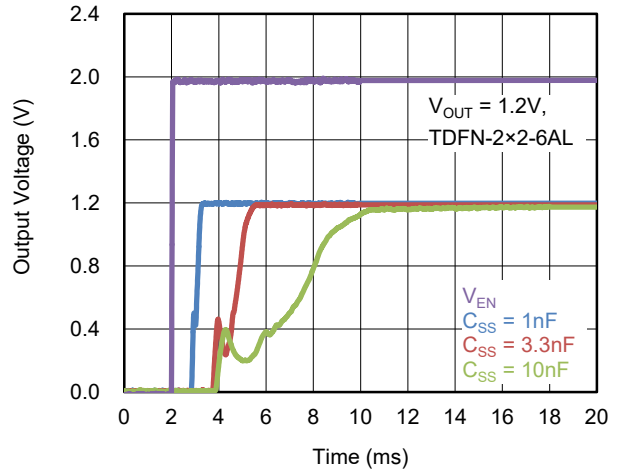

Typical Soft-Start Behavior, Different C_{SS}

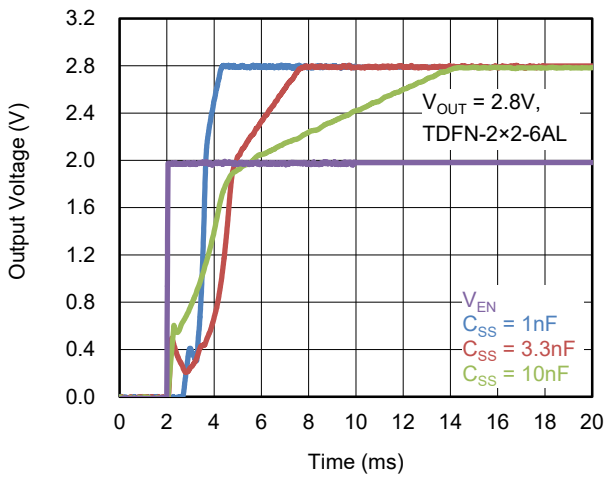

Typical Soft-Start Behavior, Different C_{SS}

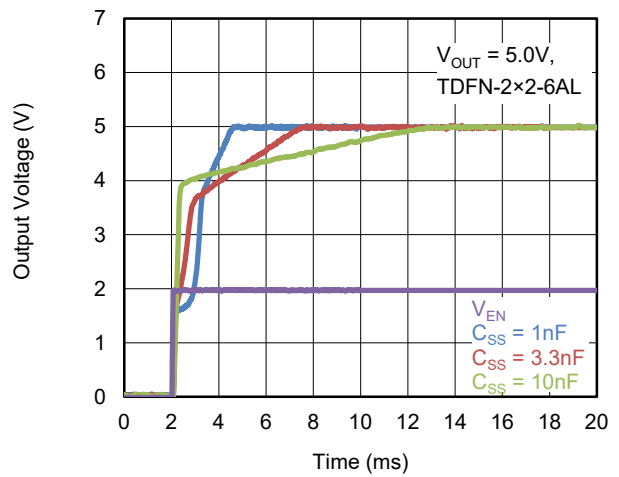

TYPICAL APPLICATION CIRCUITS

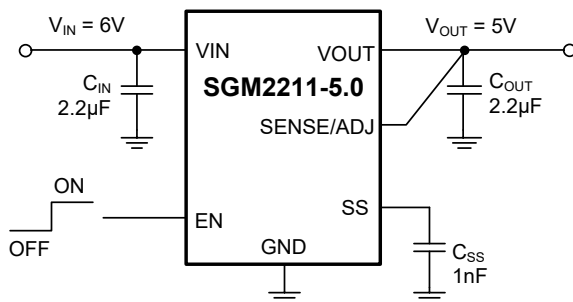

Figure 1. SGM2211 with Fixed Output Voltage, 5V (TDFN-2x2-6AL)

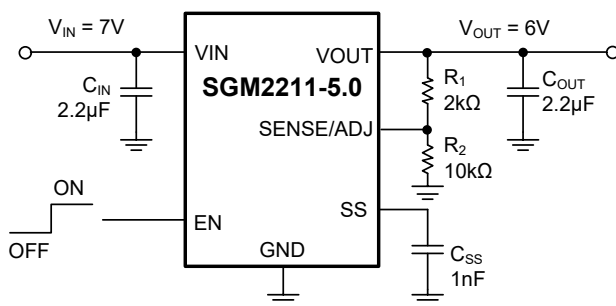

Figure 2. SGM2211 with 5V Output Adjusted to 6V (TDFN-2x2-6AL)

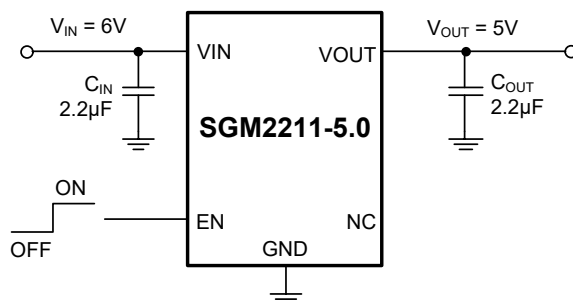

Figure 3. SGM2211 with Fixed Output Voltage, 5V (SOT-23-5)

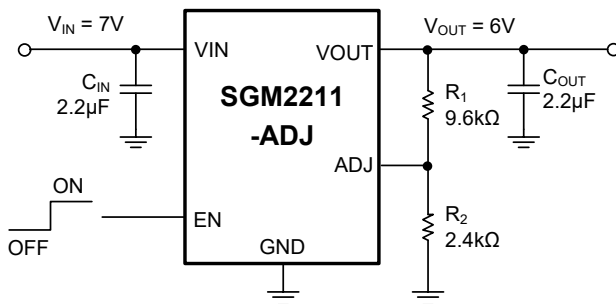

Figure 4. SGM2211 with 1.2V Output Adjusted to 6V (SOT-23-5)

FUNCTIONAL BLOCK DIAGRAM

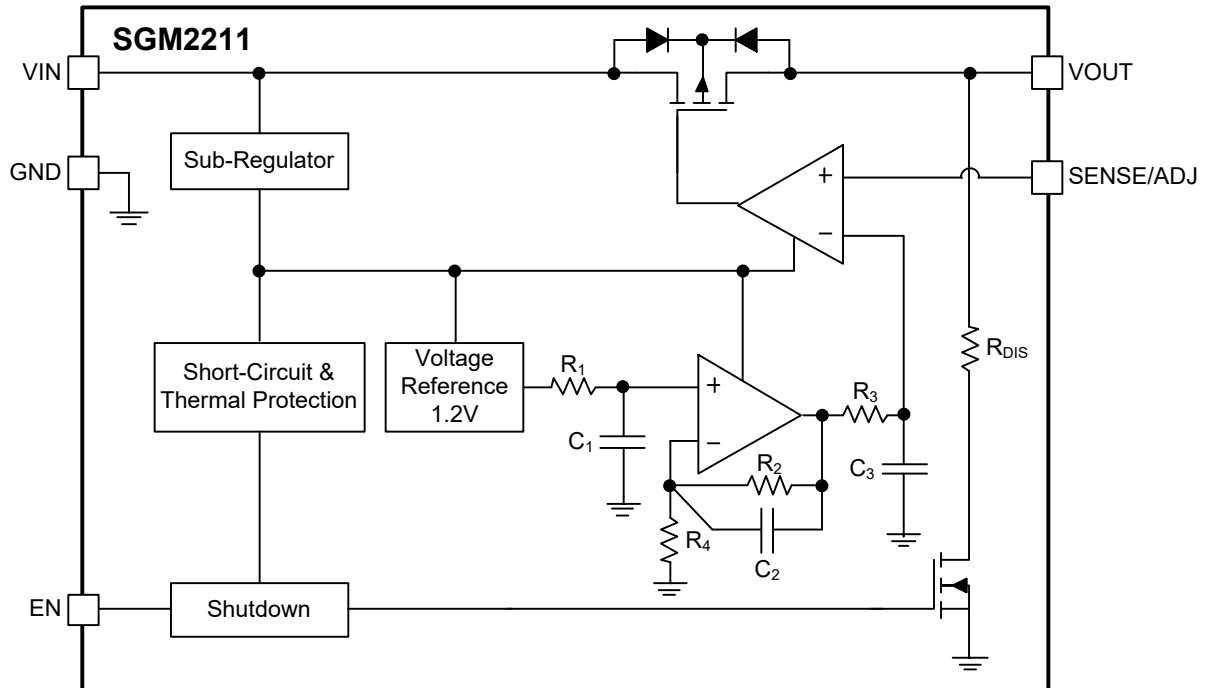

Figure 5. Block Diagram (TDFN-2x2-6AL and SOT-23-5 Adjustable Version)

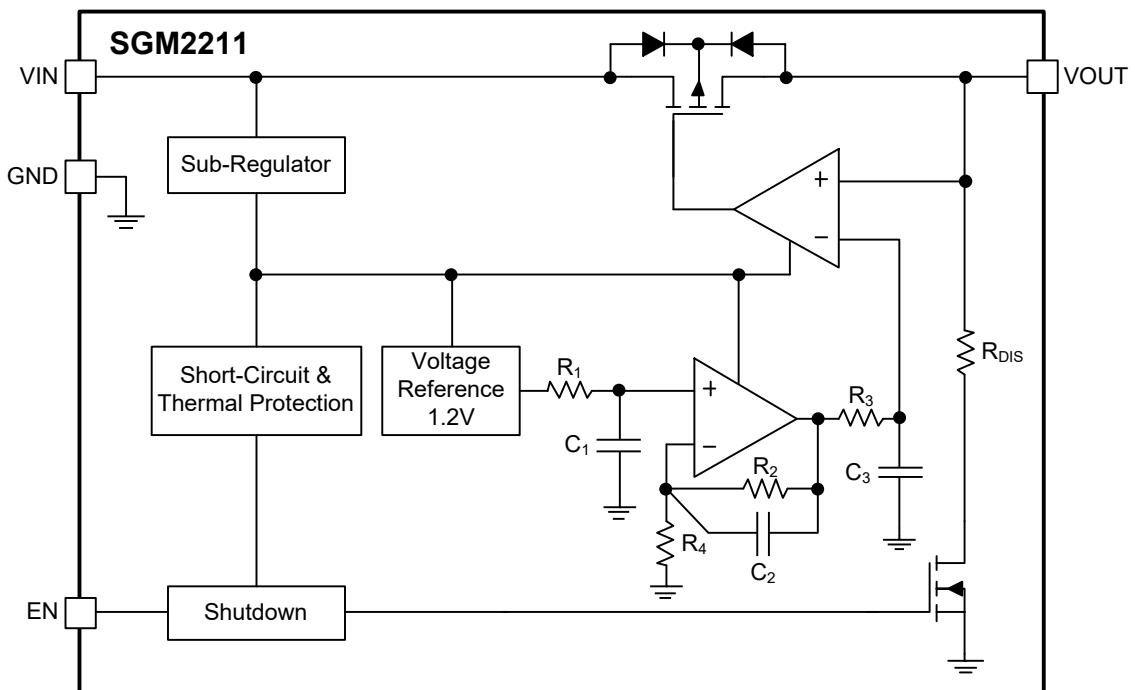

Figure 6. Block Diagram (SOT-23-5 Fixed Version)

APPLICATION INFORMATION

The SGM2211 is a low noise, fast transient response high performance LDO, it consumes only 39µA (TYP) quiescent current and provides 500mA output current. The SGM2211 provides the protection function for output overload, output short-circuit condition and overheating.

Input Capacitor (C_{IN})

The input decoupling capacitor is necessary to be connected as close as possible to the VIN pin for ensuring the device stability. 2.2µF or greater X7R or X5R ceramic capacitor is selected to get good dynamic performance.

When V_{IN} is required to provide large current instantaneously, a large effective input capacitor is required. Multiple input capacitors can limit the input tracking inductance. Adding more input capacitors is available to restrict the ringing and to keep it below the device absolute maximum ratings.

Output Capacitor (C_{OUT})

The output decoupling capacitor should be located as close as possible to the VOUT pin. A 2.2µF or greater X7R or X5R ceramic capacitor is selected to get good dynamic performance. The minimum effective capacitance of C_{OUT} that SGM2211 can remain stable is 2.2µF. For ceramic capacitor, temperature, DC bias and package size will change the effective capacitance, so enough margin of C_{OUT} must be considered in design. Larger capacitance and lower ESR C_{OUT} will help improve the load transient response and increase the high frequency PSRR.

Programmable Precision Enable Operation

The SGM2211 uses the EN pin to enable/disable the device and to deactivate/activate the output automatic discharge function.

When the EN pin voltage is lower than 1.1V, the device is in shutdown state, there is no current flowing from VIN to VOUT pins. In this state, the automatic discharge transistor is active to discharge the output voltage through a 100Ω (TYP) resistor.

When the EN pin voltage is higher than 1.2V, the device is in active state, the input voltage is regulated to the output voltage and the automatic discharge transistor is turned off.

The EN pin voltage threshold can be programmed by the user and set above the nominal 1.2V by using two resistors (R_{EN1}, R_{EN2}) as shown in Figure 7. The nominal range of R_{EN2} is 10KΩ to 100kΩ and the resistance value of R_{EN1} can be determined by the following equation:

$$R_{EN1} = R_{EN2} \times (V_{IN} - 1.2V) / 1.2V \quad (1)$$

where V_{IN} is the required starting voltage.

The coefficient of hysteresis voltage increase can be calculated through (R_{EN1} + R_{EN2}) / R_{EN2}. It is calculated that the EN pin voltage threshold is 3.6V and the voltage increase is 300mV.

Soft-Start

When the device is enabled, the SGM2211 has an internal soft-start (SS pin open) to limit the inrush current. When V_{OUT} = 1.2V, the start-up time is 150µs (TYP).

Adjustable Regulator

The output voltage of the SGM2211 can be adjusted from 1.2V to (V_{IN} - V_{DROP}). The ADJ pin will be connected with two external resistors as shown in Figure 7, the output voltage is determined by the following equation:

$$V_{OUT} = V_{ADJ} \times \left(1 + \frac{R_1}{R_2} \right) \quad (2)$$

where:

V_{OUT} is output voltage and V_{ADJ} is the internal voltage reference, V_{ADJ} = 1.2V.

The parallel capacitor (C_{FF}) with R₁ can be used to improve the feedback loop stability and PSRR, increase the transient response and reduce the AC gain of the error amplifier and output noise.

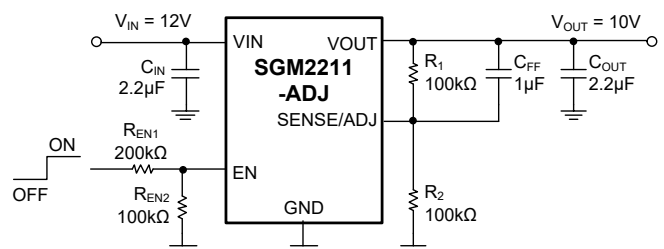

Figure 7. Adjustable Output Voltage Application

APPLICATION INFORMATION (continued)**Output Current Limit and Short-Circuit Protection**

When overload events happen, the output current is internally limited to 0.8A (TYP). When the V_{OUT} pin is shorted to ground, the short-circuit protection will limit the output current

Thermal Shutdown

The SGM2211 can detect the temperature of die. When the die temperature exceeds the threshold value of thermal shutdown, the SGM2211 will be in shutdown state and it will remain in this state until the die temperature decreases to +140°C.

Reverse Current Protection

The NMOS power transistor has an inherent body diode, this body diode will be forward biased when

$V_{OUT} > V_{IN}$. When $V_{OUT} > V_{IN}$, the reverse current flowing from the V_{OUT} pin to the V_{IN} pin will damage the SGM2211. If $V_{OUT} > (V_{IN} + 0.3V)$ is expected in the application, one external Schottky diode will be added between the V_{OUT} pin and V_{IN} pin to protect the SGM2211.

Layout Guidelines

To get good PSRR, low output noise and high transient response performance, the input and output bypass capacitors must be placed as close as possible to the V_{IN} pin and V_{OUT} pin separately. V_{IN} and V_{OUT} had better use separate ground planes and these ground planes are single point connected to the GND pin.

REVISION HISTORY

NOTE: Page numbers for previous revisions may differ from page numbers in the current version.

	Page
MARCH 2020 - REV.A to REV.A.1	
Updated Figure 7.....	14
Changes from Original (DECEMBER 2019) to REV.A	Page
Changed from product preview to production data	All

PACKAGE OUTLINE DIMENSIONS

TDFN-2x2-6AL

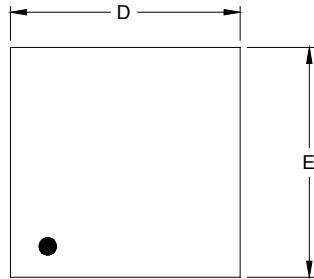

TOP VIEW

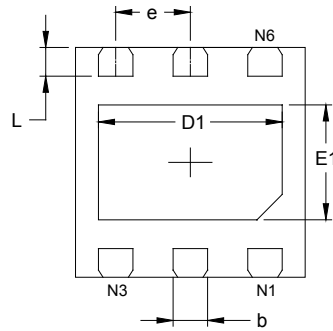

BOTTOM VIEW

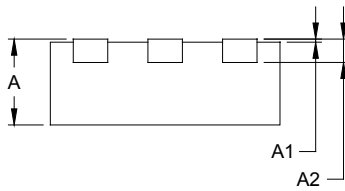

SIDE VIEW

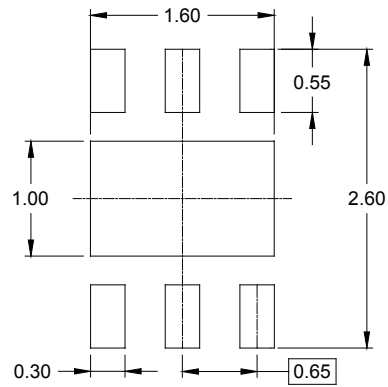

RECOMMENDED LAND PATTERN (Unit: mm)

Symbol	Dimensions In Millimeters		Dimensions In Inches	
	MIN	MAX	MIN	MAX
A	0.700	0.800	0.028	0.031
A1	0.000	0.050	0.000	0.002
A2	0.203 REF		0.008 REF	
D	1.900	2.100	0.075	0.083
D1	1.500	1.700	0.059	0.067
E	1.900	2.100	0.075	0.083
E1	0.900	1.100	0.035	0.043
b	0.250	0.350	0.010	0.014
e	0.650 BSC		0.026 BSC	
L	0.174	0.326	0.007	0.013

PACKAGE OUTLINE DIMENSIONS

SOT-23-5

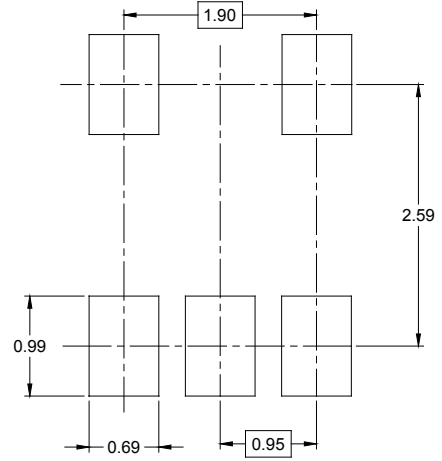
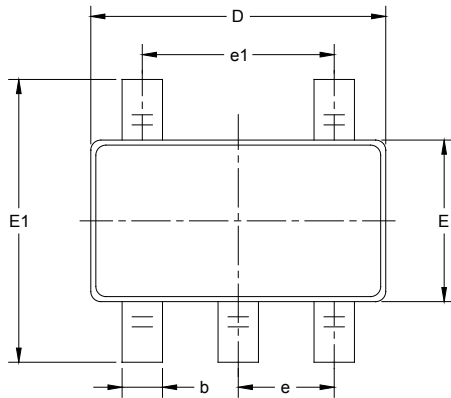

RECOMMENDED LAND PATTERN (Unit: mm)

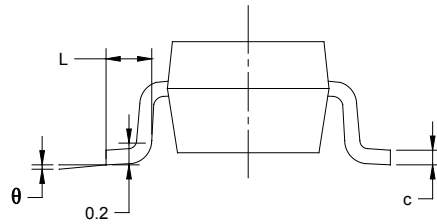
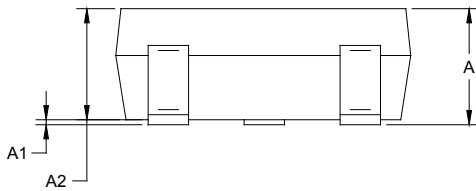

Symbol	Dimensions In Millimeters		Dimensions In Inches	
	MIN	MAX	MIN	MAX
A	1.050	1.250	0.041	0.049
A1	0.000	0.100	0.000	0.004
A2	1.050	1.150	0.041	0.045
b	0.300	0.500	0.012	0.020
c	0.100	0.200	0.004	0.008
D	2.820	3.020	0.111	0.119
E	1.500	1.700	0.059	0.067
E1	2.650	2.950	0.104	0.116
e	0.950 BSC		0.037 BSC	
e1	1.900 BSC		0.075 BSC	
L	0.300	0.600	0.012	0.024
θ	0°	8°	0°	8°

TAPE AND REEL INFORMATION

REEL DIMENSIONS



TAPE DIMENSIONS



NOTE: The picture is only for reference. Please make the object as the standard.

KEY PARAMETER LIST OF TAPE AND REEL

Package Type	Reel Diameter	Reel Width W1 (mm)	A0 (mm)	B0 (mm)	K0 (mm)	P0 (mm)	P1 (mm)	P2 (mm)	W (mm)	Pin1 Quadrant
TDFN-2×2-6AL	7"	9.5	2.30	2.30	1.10	4.0	4.0	2.0	8.0	Q1
SOT-23-5	7"	9.5	3.20	3.20	1.40	4.0	4.0	2.0	8.0	Q3

DD0001

PACKAGE INFORMATION

CARTON BOX DIMENSIONS

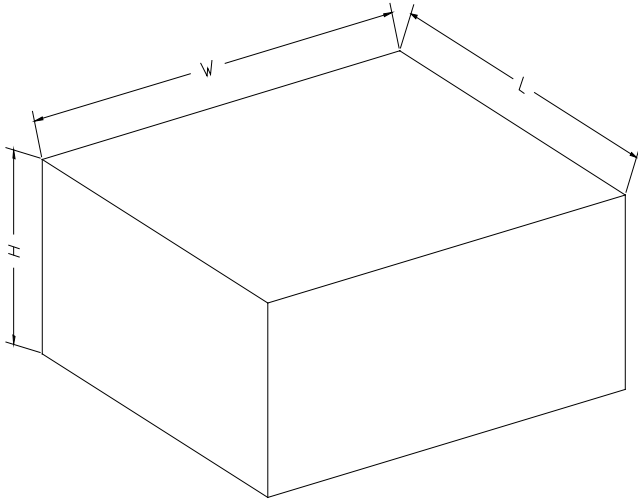

NOTE: The picture is only for reference. Please make the object as the standard.

KEY PARAMETER LIST OF CARTON BOX

Reel Type	Length (mm)	Width (mm)	Height (mm)	Pizza/Carton
7" (Option)	368	227	224	8
7"	442	410	224	18

DD0002