



# SGM8770

## High Voltage, High Precision, Dual Differential Comparator

---

### GENERAL DESCRIPTION

The SGM8770 consists of two independent voltage comparators that are designed to operate from a single power supply or dual power supplies over a wide voltage range. For dual supplies application, the difference between the two supplies is 2.8V to 36V. Input common mode voltage is 1.5V lower than  $+V_S$ . Low supply current is independent of the supply voltage. The outputs can be connected to other open-drain outputs to achieve wired-AND relationships.

The SGM8770 is available in Green SOIC-8 and TDFN-3×3-8L packages. The SGM8770 is specified over the extended  $-40^{\circ}\text{C}$  to  $+125^{\circ}\text{C}$  temperature range.

### FEATURES

- **Single Supply or Dual Supplies**
- **Wide Supply Voltage Range: 2.8V to 36V**
- **Open-Drain Output**
- **Low Supply Current Independent of Supply Voltage: 310 $\mu\text{A}$  (TYP)**
- **Low Input Offset Voltage: 2.4mV (MAX)**
- **Low Input Bias Current:  $\pm 20\text{pA}$  (TYP)**
- **Input Common Mode Voltage Range Includes Ground**
- **Differential Input Voltage Range Equal to Maximum-Rated Supply Voltage:  $\pm 36\text{V}$**
- **Low Output Saturation Voltage**
- **Output Compatible with TTL and CMOS**
- **$-40^{\circ}\text{C}$  to  $+125^{\circ}\text{C}$  Operating Temperature Range**
- **Available in Green SOIC-8 and TDFN-3×3-8L Packages**

### APPLICATIONS

Power System  
Battery Monitor  
Industrial Control

**PACKAGE/ORDERING INFORMATION**

MODEL	PACKAGE DESCRIPTION	SPECIFIED TEMPERATURE RANGE	ORDERING NUMBER	PACKAGE MARKING	PACKING OPTION
SGM8770	SOIC-8	-40°C to +125°C	SGM8770XS8G/TR	SGM 8770XS8 XXXXX	Tape and Reel, 4000
	TDFN-3x3-8L	-40°C to +125°C	SGM8770XTDB8G/TR	SGM 8770DB XXXXX	Tape and Reel, 4000

**MARKING INFORMATION**

NOTE: XXXXX = Date Code, Trace Code and Vendor Code.

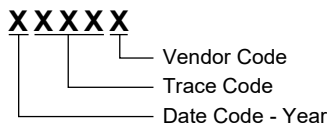

Green (RoHS & HSF): SG Micro Corp defines "Green" to mean Pb-Free (RoHS compatible) and free of halogen substances. If you have additional comments or questions, please contact your SGMICRO representative directly.

**ABSOLUTE MAXIMUM RATINGS**

Supply Voltage, +Vs to -Vs .....	40V
Differential Input Voltage,  V <sub>ID</sub>   .....	40V
Input/Output Voltage Range .....	(-V <sub>S</sub> ) - 0.3V to (+V <sub>S</sub> ) + 0.3V
Junction Temperature .....	+150°C
Storage Temperature Range .....	-65°C to +150°C
Lead Temperature (Soldering, 10s) .....	+260°C
ESD Susceptibility	
HBM .....	2500V
MM .....	400V
CDM .....	1000V

absolute maximum rating conditions for extended periods may affect reliability. Functional operation of the device at any conditions beyond those indicated in the Recommended Operating Conditions section is not implied.

**RECOMMENDED OPERATING CONDITIONS**

Operating Temperature Range .....	-40°C to +125°C
Power Supply Range .....	2.8V to 36V

**ESD SENSITIVITY CAUTION**

This integrated circuit can be damaged by ESD if you don't pay attention to ESD protection. SGMICRO recommends that all integrated circuits be handled with appropriate precautions. Failure to observe proper handling and installation procedures can cause damage. ESD damage can range from subtle performance degradation to complete device failure. Precision integrated circuits may be more susceptible to damage because very small parametric changes could cause the device not to meet its published specifications.

**OVERSTRESS CAUTION**

Stresses beyond those listed in Absolute Maximum Ratings may cause permanent damage to the device. Exposure to

**DISCLAIMER**

SG Micro Corp reserves the right to make any change in circuit design, or specifications without prior notice.

**PIN CONFIGURATIONS**

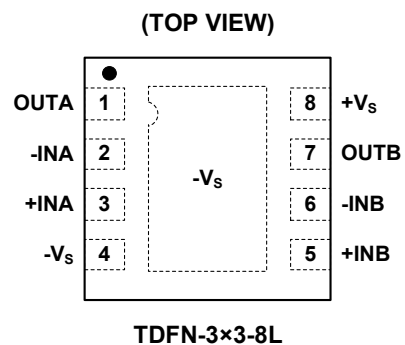
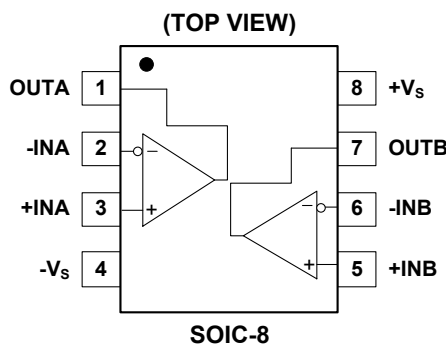

**ELECTRICAL CHARACTERISTICS**

(At T<sub>A</sub> = +25°C, V<sub>S</sub> = ±1.4V to ±18V, Full = -40°C to +125°C, unless otherwise noted.)

PARAMETER	SYMBOL	CONDITIONS	TEMP	MIN	TYP	MAX	UNITS
Input Offset Voltage	V <sub>OS</sub>	V <sub>CM</sub> = 0V	+25°C		0.6	2.4	mV
			Full			2.8	
Input Bias Current	I <sub>B</sub>	V <sub>CM</sub> = 0V	+25°C		±20	±240	µA
Input Offset Current	I <sub>OS</sub>	V <sub>CM</sub> = 0V	+25°C		±20	±320	µA
Maximum Differential Input Voltage	V <sub>ID</sub>		Full			(+V <sub>S</sub> ) - (-V <sub>S</sub> )	V
Maximum Input Difference Bias Current	I <sub>ID</sub>	V <sub>S</sub> = ±18V, V <sub>ID</sub> = ±18V	+25°C		2.2	3	µA
			Full			5	
Input Common Mode Voltage Range <sup>(1)</sup>	V <sub>CM</sub>		Full	-V <sub>S</sub>		(+V <sub>S</sub> ) - 1.5	V
Common Mode Rejection Ratio	CMRR	V <sub>S</sub> = ±18V, V <sub>CM</sub> = -V <sub>S</sub> to (+V <sub>S</sub> ) - 1.5V	+25°C	96	116		dB
			Full	80			
Power Supply Rejection Ratio	PSRR	V <sub>S</sub> = 2.8V to 36V	+25°C	98	116		dB
			Full	95			
Large-Signal Differential Voltage Amplification	A <sub>VD</sub>	V <sub>S</sub> = 36V, V <sub>OUT</sub> = 0.1V to 28.8V, R <sub>L</sub> = 120kΩ to V <sub>S</sub>	+25°C	90	100		dB
			Full	87			
Output Voltage Swing from Rail	V <sub>OL</sub>	I <sub>SINK</sub> = 8mA, V <sub>ID</sub> = -0.2V	+25°C		200	280	mV
			Full			410	
Output Short-Circuit Current	I <sub>SINK</sub>	V <sub>OL</sub> = (-V <sub>S</sub> ) + 1.5V, V <sub>ID</sub> = -0.2V	+25°C	24	36		mA
High-Level Output Current	I <sub>OH</sub>	V <sub>OH</sub> = 2.8V, V <sub>ID</sub> = 0.2V	+25°C		0.4	0.8	µA
			Full			1	
		V <sub>OH</sub> = 36V, V <sub>ID</sub> = 0.2V	+25°C		6	9	µA
			Full			62	
Total Supply Current	I <sub>S</sub>	I <sub>OUT</sub> = 0mA	+25°C		310	380	µA
			Full			430	

**SWITCHING CHARACTERISTICS**

(At T<sub>A</sub> = +25°C, V<sub>S</sub> = ±2.5V, C<sub>L</sub> = 15pF <sup>(2)</sup>, unless otherwise specified.)

PARAMETER	SYMBOL	CONDITIONS	TEMP	MIN	TYP	MAX	UNITS
Propagation Delay (High to Low)	t <sub>PHL</sub>	Overdrive = 10mV	+25°C		75		ns
		Overdrive = 100mV	+25°C		45		ns
Fall Time	t <sub>FALL</sub>	Overdrive = 10mV	+25°C		15		ns
		Overdrive = 100mV	+25°C		15		ns

NOTES:

1. The voltage at either input should not be allowed to be lower than (-V<sub>S</sub>) - 0.3V. The upper end of the common mode voltage range is (+V<sub>S</sub>) - 1.5V, but either input can go up to 36V without damage.
2. C<sub>L</sub> includes probe and jig capacitance.

TYPICAL PERFORMANCE CHARACTERISTICS

At  $T_A = +25^\circ\text{C}$ ,  $V_S = \pm 18\text{V}$  and  $C_L = 15\text{pF}$ , unless otherwise noted.

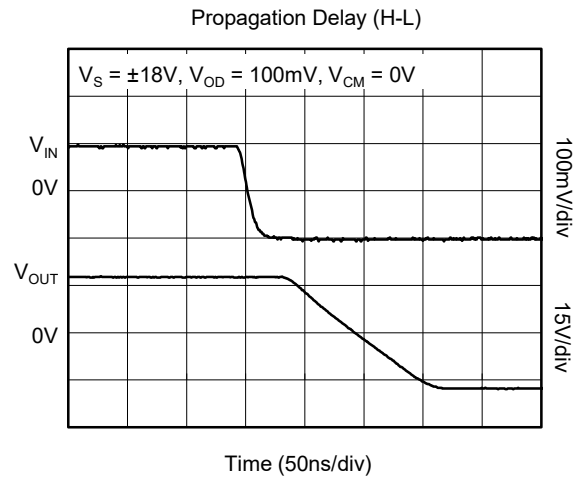
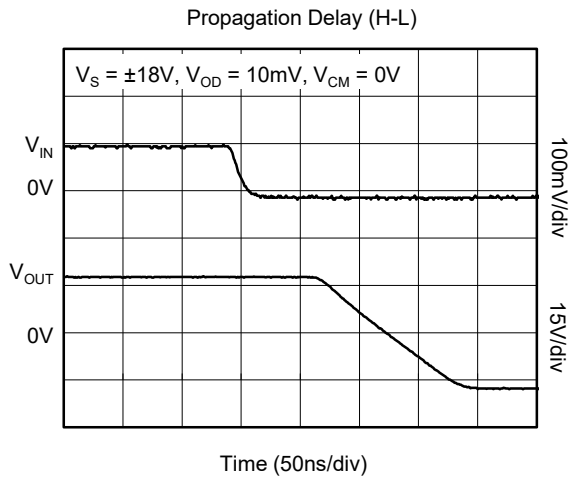
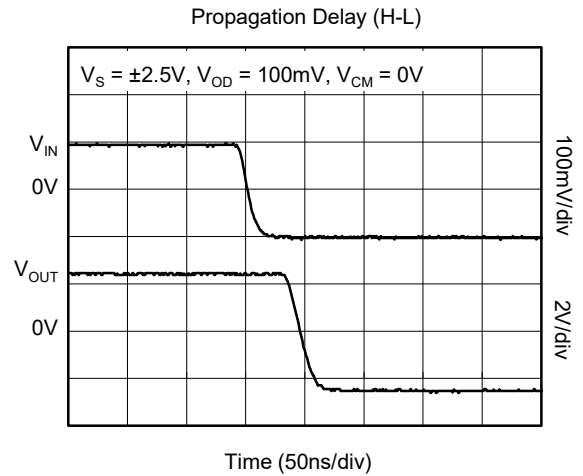
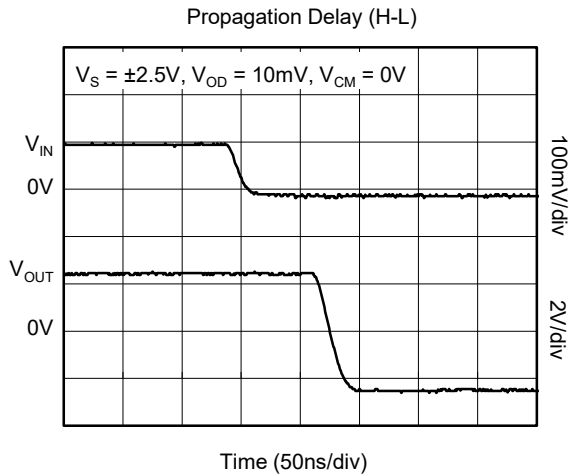
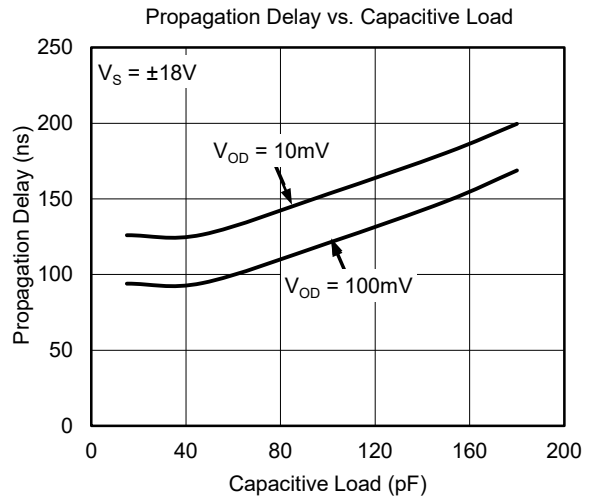
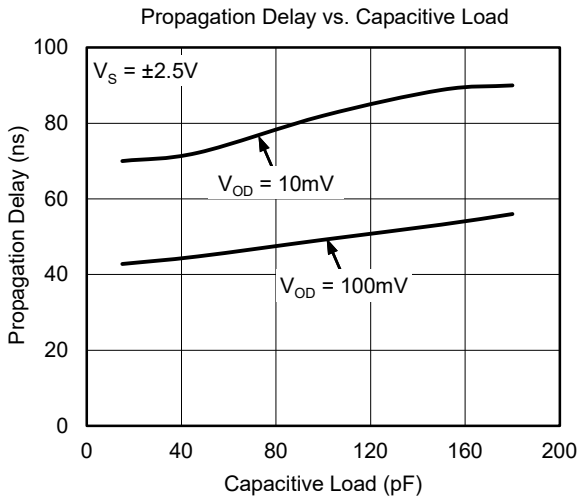

**TYPICAL PERFORMANCE CHARACTERISTICS (continued)**

At  $T_A = +25^\circ\text{C}$ ,  $V_S = \pm 18\text{V}$  and  $C_L = 15\text{pF}$ , unless otherwise noted.

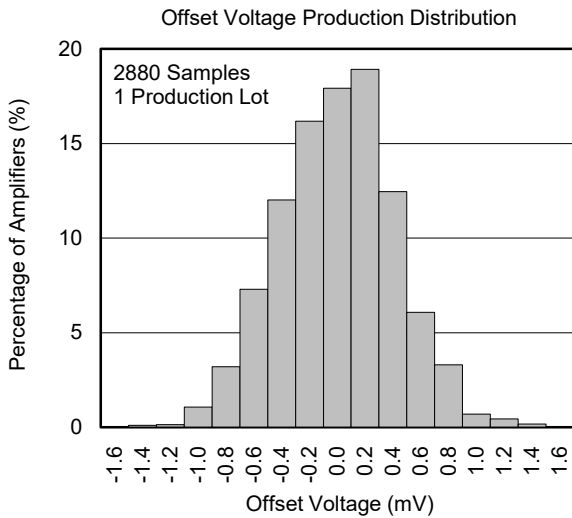
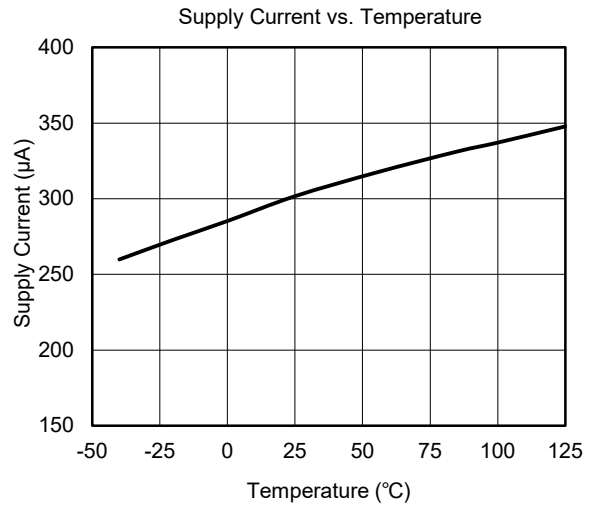
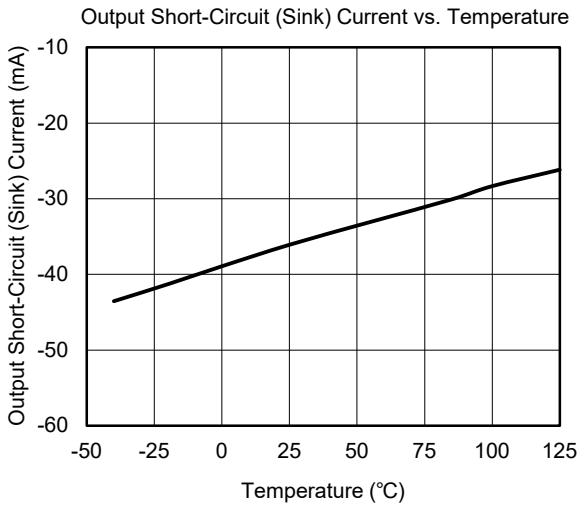
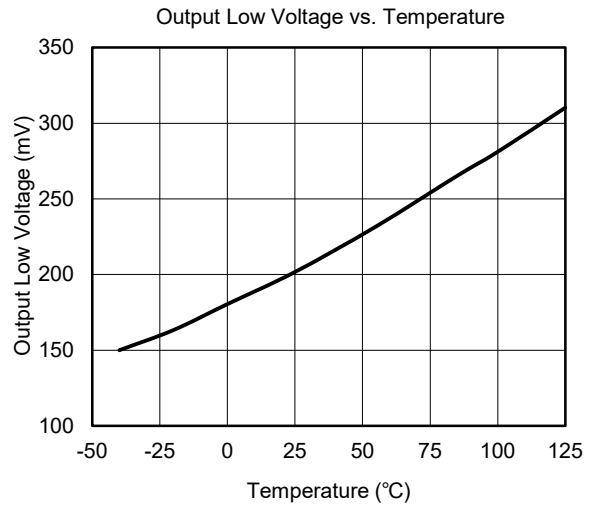
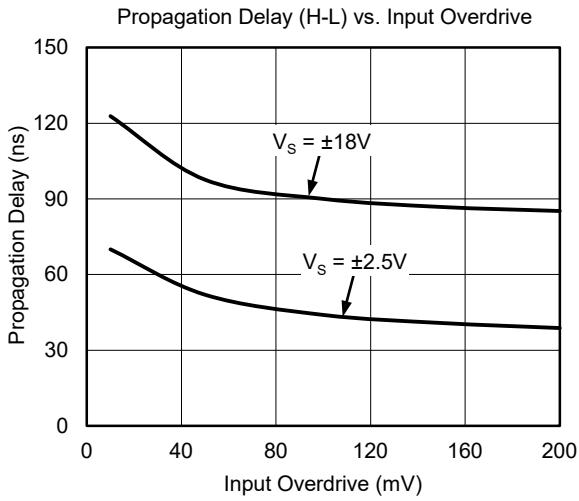

**DETAILED DESCRIPTION**

The SGM8770 includes dual comparators that feature high precision and low power. Open-drain structure needs external pull-up resistor. The wide input voltage range and power supply range make the device ideal for industrial equipment. The SGM8770 can interface directly with CMOS and TTL logics.

**Output Stage Circuitry**

The SGM8770 contains an open-drain current-driven output stage as shown in Figure 1. During an output transition,  $I_{SINK}$  pulls output pin to logic low. The output sink current is larger during the transition, creating a high slew rate. Once the output voltage reaches  $V_{OL}$ , the sink current will decrease to a small value, capable of maintaining the  $V_{OL}$  static condition. This significant decrease in current conserves power after an output transition has occurred.

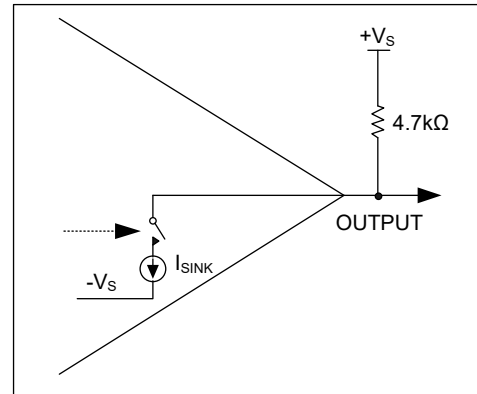

**Figure 1. Open Drain Output Stage Circuitry**

One consequence of a current-driven output stage is a linear dependence between the slew rate and the load capacitance. A heavy capacitive load will slow down a voltage output transition. This can be useful in noise-sensitive applications where fast edges may cause interference.

**APPLICATION INFORMATION**

**Circuit Layout and Bypassing**

The SGM8770 requires design precautions to realize the full high-speed capabilities of the comparator. The recommended precautions are:

- 1) Use a PCB with a good, unbroken, low-inductance ground plane.
- 2) Place a decoupling capacitor (a 0.1μF ceramic capacitor is a good choice) as close to +V<sub>S</sub> as possible.

- 3) Pay close attention to the decoupling capacitor's bandwidth, keeping leads short.
- 4) On the inputs and output, keep lead lengths short to avoid unwanted parasitic feedback around the comparator.
- 5) Solder the device directly to the PCB instead of using a socket.

**REVISION HISTORY**

NOTE: Page numbers for previous revisions may differ from page numbers in the current version.

**Changes from Original (DECEMBER 2018) to REV.A**

Changed from product preview to production data.....	All
--	-----

PACKAGE OUTLINE DIMENSIONS

SOIC-8

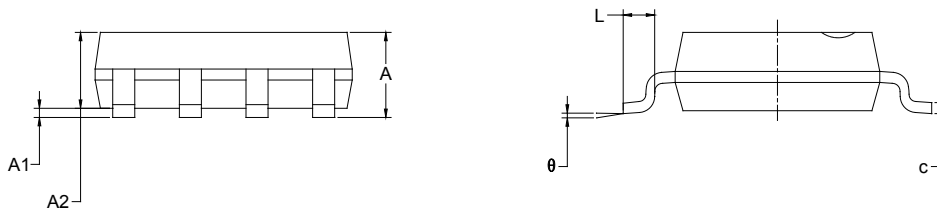
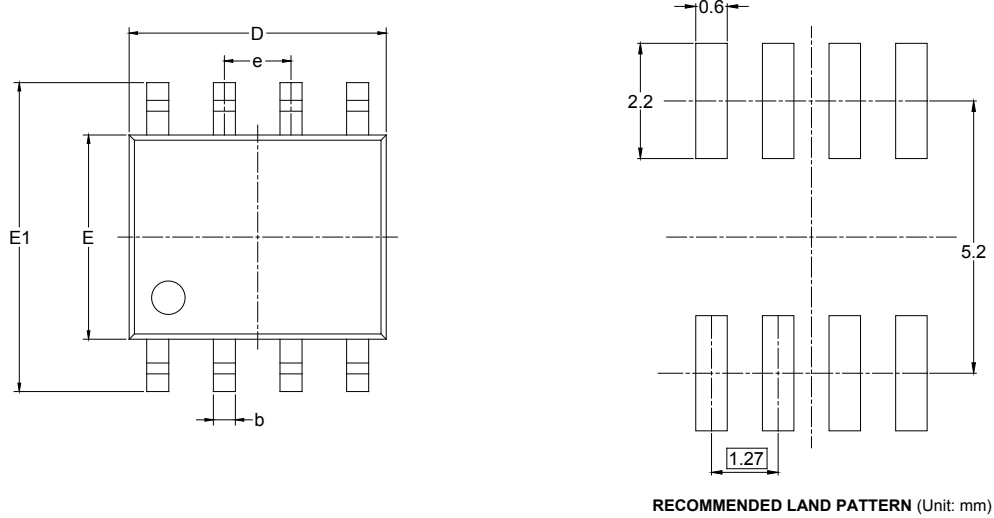

Symbol	Dimensions In Millimeters		Dimensions In Inches	
	MIN	MAX	MIN	MAX
A	1.350	1.750	0.053	0.069
A1	0.100	0.250	0.004	0.010
A2	1.350	1.550	0.053	0.061
b	0.330	0.510	0.013	0.020
c	0.170	0.250	0.006	0.010
D	4.700	5.100	0.185	0.200
E	3.800	4.000	0.150	0.157
E1	5.800	6.200	0.228	0.244
e	1.27 BSC		0.050 BSC	
L	0.400	1.270	0.016	0.050
θ	0°	8°	0°	8°

PACKAGE OUTLINE DIMENSIONS

TDFN-3x3-8L

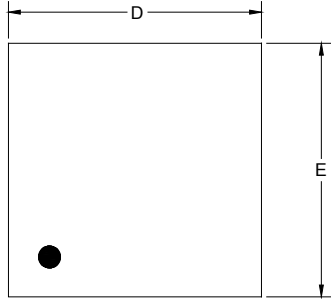

TOP VIEW

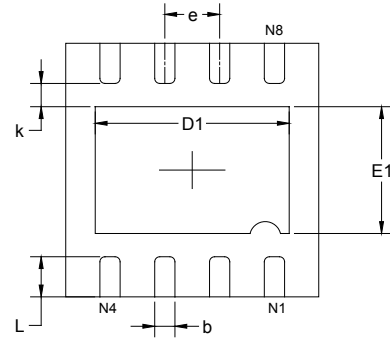

BOTTOM VIEW

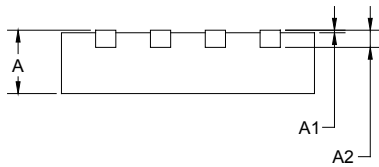

SIDE VIEW

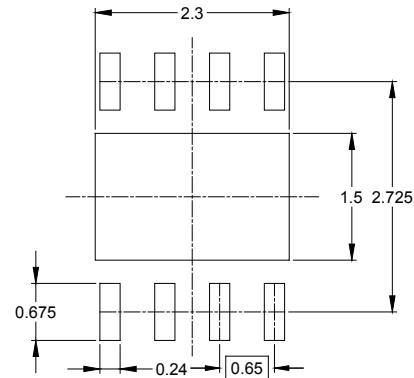

RECOMMENDED LAND PATTERN (Unit: mm)

Symbol	Dimensions In Millimeters		Dimensions In Inches	
	MIN	MAX	MIN	MAX
A	0.700	0.800	0.028	0.031
A1	0.000	0.050	0.000	0.002
A2	0.203 REF		0.008 REF	
D	2.900	3.100	0.114	0.122
D1	2.200	2.400	0.087	0.094
E	2.900	3.100	0.114	0.122
E1	1.400	1.600	0.055	0.063
k	0.200 MIN		0.008 MIN	
b	0.180	0.300	0.007	0.012
e	0.650 TYP		0.026 TYP	
L	0.375	0.575	0.015	0.023



TAPE AND REEL INFORMATION

REEL DIMENSIONS



TAPE DIMENSIONS



NOTE: The picture is only for reference. Please make the object as the standard.

KEY PARAMETER LIST OF TAPE AND REEL

Package Type	Reel Diameter	Reel Width W1 (mm)	A0 (mm)	B0 (mm)	K0 (mm)	P0 (mm)	P1 (mm)	P2 (mm)	W (mm)	Pin1 Quadrant
SOIC-8	13"	12.4	6.40	5.40	2.10	4.0	8.0	2.0	12.0	Q1
TDFN-3×3-8L	13"	12.4	3.35	3.35	1.13	4.0	8.0	2.0	12.0	Q1

DD0001

# PACKAGE INFORMATION

## CARTON BOX DIMENSIONS



NOTE: The picture is only for reference. Please make the object as the standard.

## KEY PARAMETER LIST OF CARTON BOX

Reel Type	Length (mm)	Width (mm)	Height (mm)	Pizza/Carton
13"	386	280	370	5

DD0002