



SGM8925/SGM8927

110kHz, 6.4 μ A, Rail-to-Rail Output CMOS Operational Amplifiers

GENERAL DESCRIPTION

The SGM8925 and SGM8927 are low power, low offset voltage and rail-to-rail output voltage feedback amplifiers. They have a wide output voltage swing, and take the minimum operating supply voltage down to 1.6V. The maximum recommended supply voltage is 5.5V.

The SGM8925 and SGM8927 provide 110kHz bandwidth at a low current consumption of 6.4 μ A. Very low input bias currents of 1pA enable these amplifiers to be used for integrators, photodiode amplifiers and piezoelectric sensors. Rail-to-rail output is useful to designers for buffering ASIC in single-supply systems.

Applications for these amplifiers also include safety monitoring, portable equipment, battery and power supply control, signal conditioning and interfacing for transducers in very low power systems.

The SGM8925 single is available in Green SOT-23-5, SC70-5, MSOP-8 and SOIC-8 packages. The SGM8927 single with shutdown is available in Green SOT-23-6, MSOP-8 and SOIC-8 packages. They are specified over the extended -40°C to +85°C temperature range.

FEATURES

- **Low Offset Voltage: 0.6mV (MAX)**
- **Rail-to-Rail Output**
- **Unity Gain Stable**
- **Gain-Bandwidth Product: 110kHz**
- **Supply Voltage Range: 1.6V to 5.5V**
- **Low Supply Current: 6.4 μ A (TYP)**
- **-40°C to +85°C Operating Temperature Range**
- **Small Packaging:**
 - SGM8925 Available in Green SOT-23-5, SC70-5, SOIC-8 and MSOP-8 Packages**
 - SGM8927 Available in Green SOT-23-6, SOIC-8 and MSOP-8 Packages**

APPLICATIONS

ASIC Input or Output Amplifier
Sensor Interface
Piezoelectric Transducer Amplifier
Medical Instrumentation
Mobile Communication
Audio Output
Portable System
Smoke Detector
Mobile Telephone
Notebook PC
PCMCIA Card
Battery-Powered Equipment

SGM8925 SGM8927

110kHz, 6.4µA, Rail-to-Rail Output CMOS Operational Amplifiers

ABSOLUTE MAXIMUM RATINGS

Supply Voltage, +V _S to -V _S	6V
Input Common Mode Voltage Range	(-V _S) - 0.1V to (+V _S) - 1.3V
Junction Temperature	+150°C
Storage Temperature Range	-65°C to +150°C
Lead Temperature (Soldering, 10s)	+260°C
ESD Susceptibility	
HBM	4000V
MM	400V

RECOMMENDED OPERATING CONDITIONS

Operating Temperature Range	-40°C to +85°C
-----------------------------------	----------------

OVERSTRESS CAUTION

Stresses beyond those listed in Absolute Maximum Ratings may cause permanent damage to the device. Exposure to absolute maximum rating conditions for extended periods may affect reliability. Functional operation of the device at any

conditions beyond those indicated in the Recommended Operating Conditions section is not implied.

ESD SENSITIVITY CAUTION

This integrated circuit can be damaged by ESD if you don't pay attention to ESD protection. SGMICRO recommends that all integrated circuits be handled with appropriate precautions. Failure to observe proper handling and installation procedures can cause damage. ESD damage can range from subtle performance degradation to complete device failure. Precision integrated circuits may be more susceptible to damage because very small parametric changes could cause the device not to meet its published specifications.

DISCLAIMER

SG Micro Corp reserves the right to make any change in circuit design, or specifications without prior notice.

PIN CONFIGURATIONS

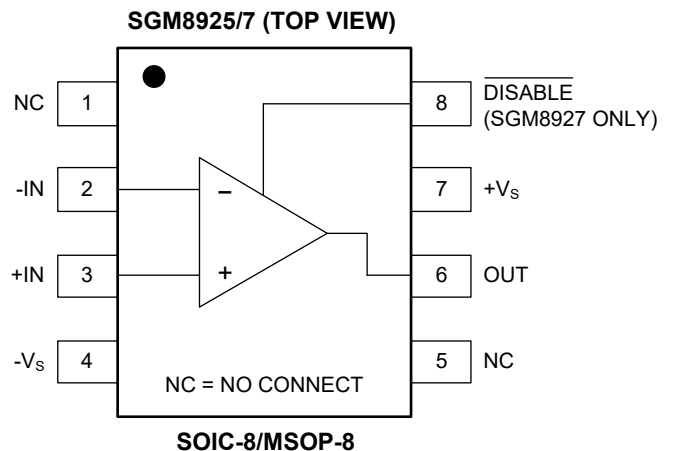
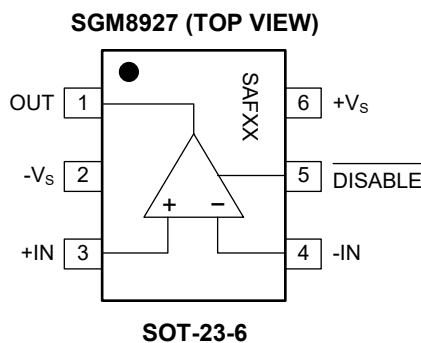
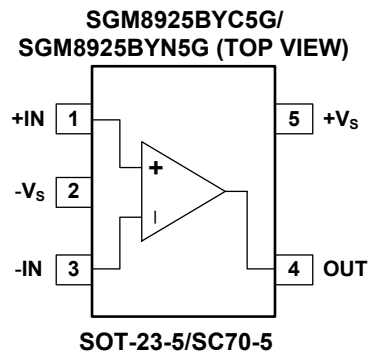
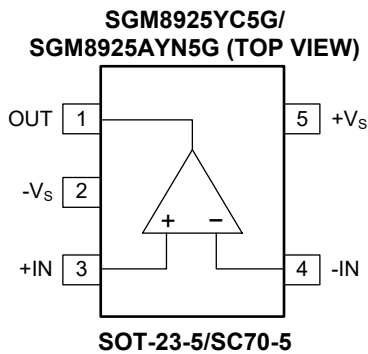

NOTE: The location of pin 1 on the SOT-23-6 is determined by orienting the package marking as shown.

ELECTRICAL CHARACTERISTICS

(At $T_A = +25^\circ\text{C}$, $V_S = 5\text{V}$, $V_{OUT} = V_S/2$, Full = -40°C to $+85^\circ\text{C}$, unless otherwise noted.)

PARAMETER	CONDITIONS	TEMP	MIN	TYP	MAX	UNITS
DC Performance						
Input Offset Voltage (V_{OS})	$V_{CM} = V_S/2$	+25°C		0.13	0.6	mV
		+25°C	SGM8925YC5G only		0.75	
Input Offset Voltage Drift ($\Delta V_{OS}/\Delta T$)		Full		2.5		$\mu\text{V}/^\circ\text{C}$
Open-Loop Voltage Gain (A_{OL})	$R_L = 100\text{k}\Omega$ to $V_S/2$, $V_{OUT} = 0.05\text{V}$ to 4.95V	+25°C		93		dB
		+25°C	80	88		
		Full	78			
Input Characteristics						
Common Mode Rejection Ratio (CMRR)	$V_{CM} = -0.1\text{V}$ to 3.7V	+25°C	70	85		dB
		Full	68			
Output Characteristics						
Output Voltage Swing from Rail	$R_L = 10\text{k}\Omega$ to $V_S/2$	+25°C		21	36	mV
		Full			40	
	$R_L = 2\text{k}\Omega$ to $V_S/2$	+25°C		80	100	
		Full			110	
Output Short-Circuit Current (I_{SC})	$R_L = 10\Omega$ to $V_S/2$	+25°C	29	36		mA
		Full	23			
Power-Down (SGM8927 Only)						
Logic Low Voltage (V_{IL})		+25°C			0.8	V
Logic High Voltage (V_{IH})		+25°C	2			
Power Supply						
Quiescent Current (I_Q)	$I_{OUT} = 0\text{mA}$	+25°C		6.4	11.5	μA
		Full			13.5	
Supply Current when Disabled (SGM8927 Only)		+25°C		0.1	1.5	μA
Power Supply Rejection Ratio (PSRR)	$V_S = 1.6\text{V}$ to 5.5V , $V_{CM} = 0.3\text{V}$	+25°C	64	77		dB
		Full	62			
Dynamic Performance						
Gain-Bandwidth Product (GBP)	$R_L = 100\text{k}\Omega$, $C_L = 100\text{pF}$, $V_{CM} = 2.5\text{V}$	+25°C		110		kHz
Slew Rate (SR)	$V_{CM} = 2.5\text{V}$	+25°C		0.04		$\text{V}/\mu\text{s}$
Noise Performance						
Input Voltage Noise Density (e_n)	$f = 1\text{kHz}$	+25°C		105		$\text{nV}/\sqrt{\text{Hz}}$

ELECTRICAL CHARACTERISTICS (continued)

(At $T_A = +25^\circ\text{C}$, $V_S = 1.6\text{V}$, $V_{CM} = 0.3\text{V}$, $V_{OUT} = V_S/2$, Full = -40°C to $+85^\circ\text{C}$, unless otherwise noted.)

PARAMETER	CONDITIONS	TEMP	MIN	TYP	MAX	UNITS
DC Performance						
Input Offset Voltage (V_{OS})		+25°C		0.28	0.6	mV
	SGM8925YC5G only	+25°C			0.75	
Input Offset Voltage Drift ($\Delta V_{OS}/\Delta T$)		Full		1.8		$\mu\text{V}/^\circ\text{C}$
Open-Loop Voltage Gain (A_{OL})	$R_L = 100\text{k}\Omega$ to $V_S/2$, $V_{OUT} = 0.05\text{V}$ to 1.55V	+25°C		99		dB
		+25°C	80	91		
	Full	78				
Input Characteristics						
Common Mode Rejection Ratio (CMRR)	$V_{CM} = -0.1\text{V}$ to 0.3V	+25°C	65	78		dB
		Full	62			
Output Characteristics						
Output Voltage Swing from Rail	$R_L = 10\text{k}\Omega$ to $V_S/2$	+25°C		13	25	mV
		Full			30	
	$R_L = 2\text{k}\Omega$ to $V_S/2$	+25°C		63	87	
		Full			95	
Output Short-Circuit Current (I_{SC})	$R_L = 10\Omega$ to $V_S/2$	+25°C	0.5	2.6		mA
		+25°C	0.35			
		Full	0.3			
Power-Down (SGM8927 Only)						
Logic Low Voltage (V_{IL})		+25°C			0.4	V
Logic High Voltage (V_{IH})		+25°C	1.1			
Power Supply						
Quiescent Current (I_Q)	$I_{OUT} = 0\text{mA}$	+25°C		5.8	10.5	μA
		Full			13	
Supply Current when Disabled (SGM8927 Only)		+25°C		0.1	1.5	μA
Dynamic Performance						
Gain-Bandwidth Product (GBP)	$R_L = 100\text{k}\Omega$, $C_L = 100\text{pF}$	+25°C		110		kHz
Slew Rate (SR)		+25°C		0.04		$\text{V}/\mu\text{s}$
Noise Performance						
Input Voltage Noise Density (e_n)	$f = 1\text{kHz}$	+25°C		105		$\text{nV}/\sqrt{\text{Hz}}$

TYPICAL PERFORMANCE CHARACTERISTICS

At $T_A = +25^\circ\text{C}$, $V_S = 5\text{V}$, unless otherwise noted.

Small Signal Step Response

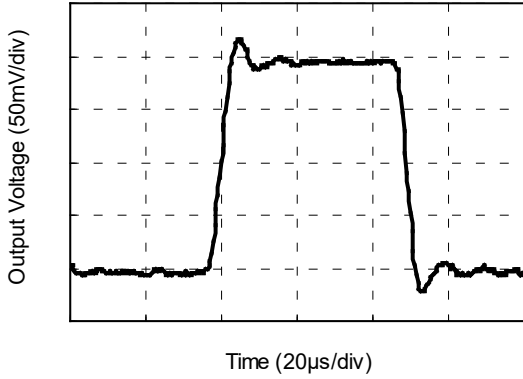

Large Signal Step Response

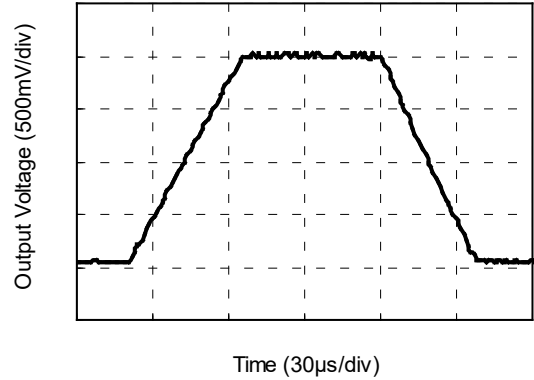

CMRR and PSRR vs. Frequency

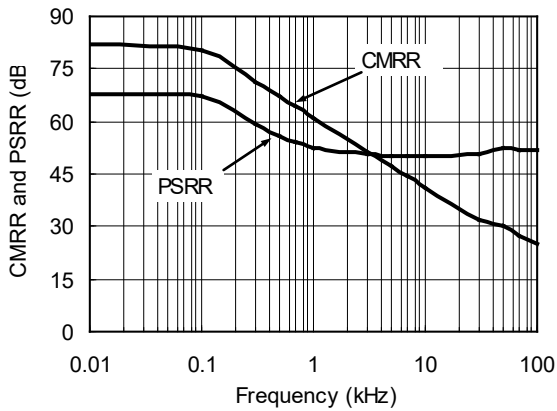

Input Voltage Noise Spectral Density vs. Frequency

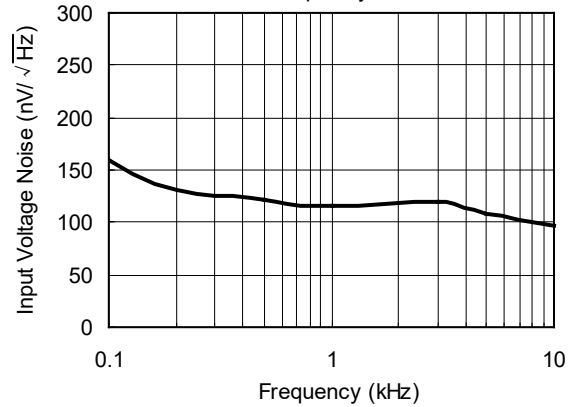

Quiescent Current vs. Temperature

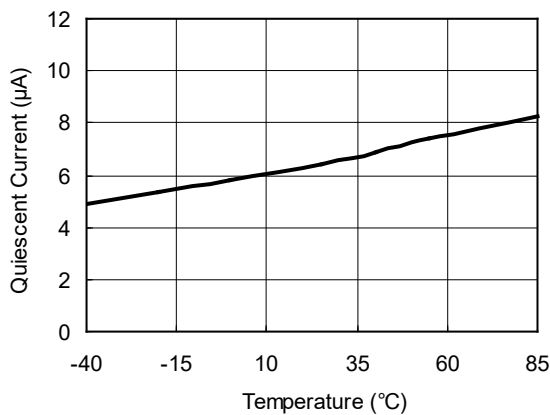

Open-Loop Voltage Gain vs. Temperature

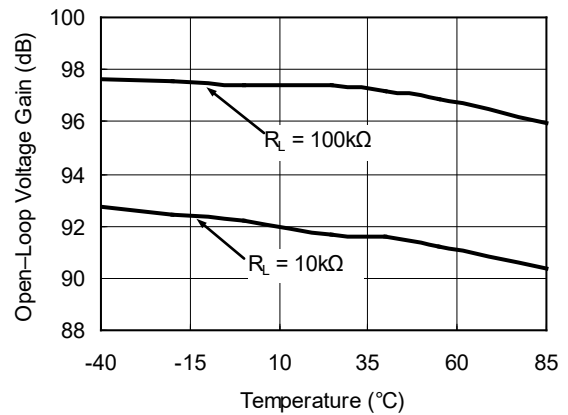

TYPICAL PERFORMANCE CHARACTERISTICS (continued)

At $T_A = +25^\circ\text{C}$, $V_S = 5\text{V}$, unless otherwise noted.

Common Mode Rejection Ratio vs. Temperature

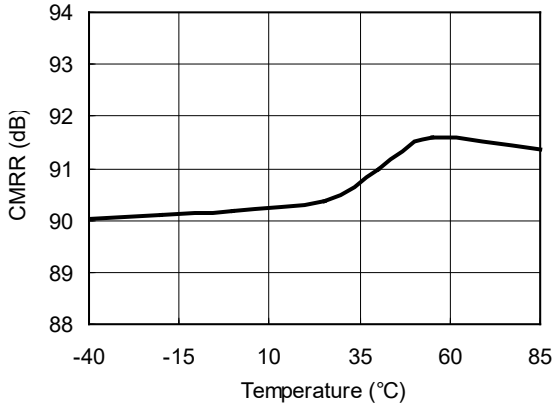

Power Supply Rejection Ratio vs. Temperature

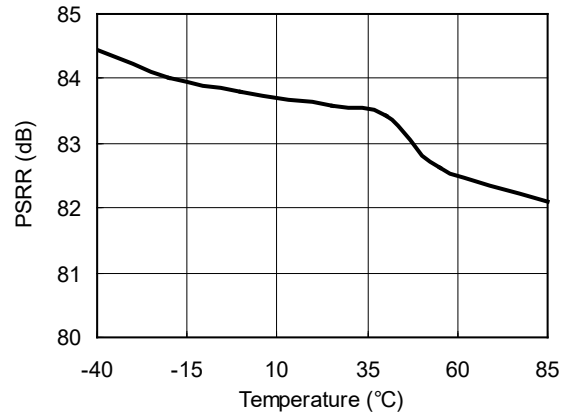

Supply Current vs. Supply Voltage

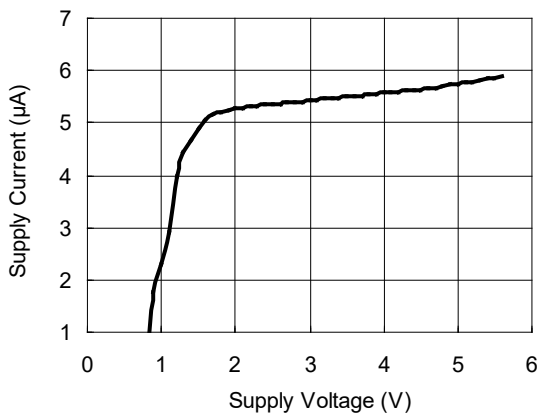

Output Voltage vs. Output Current

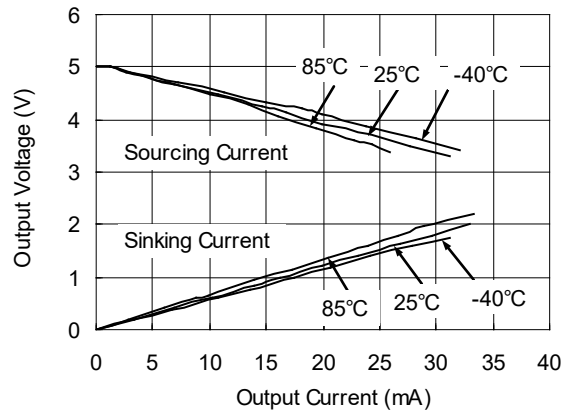

Small Signal Disable/Enable Response

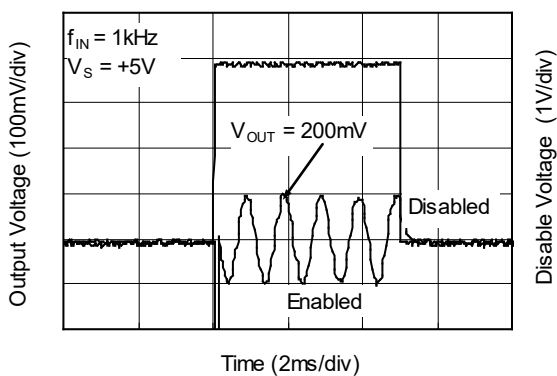

0.1Hz to 10Hz Noise at +5V

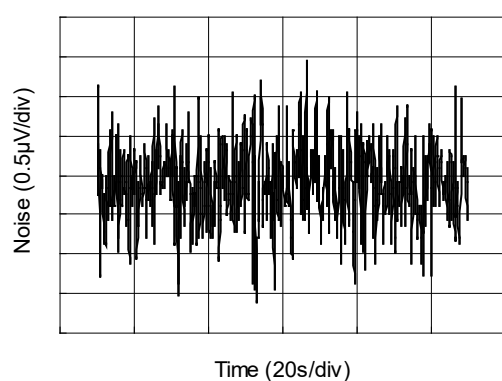

TYPICAL PERFORMANCE CHARACTERISTICS (continued)

At $T_A = +25^\circ\text{C}$, $V_S = 5\text{V}$, unless otherwise noted.

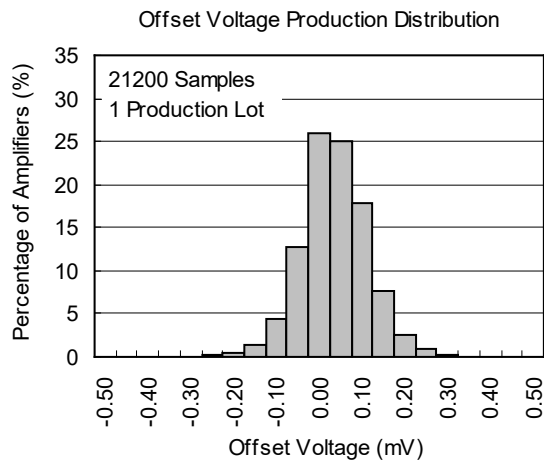
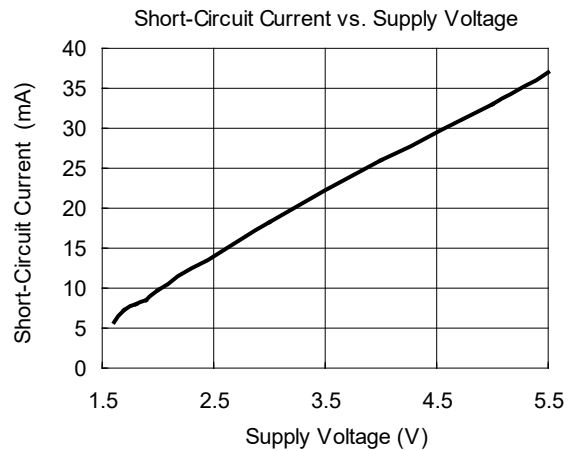
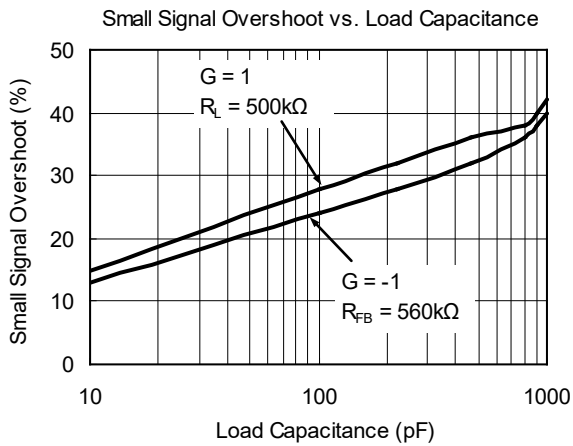

REVISION HISTORY

NOTE: Page numbers for previous revisions may differ from page numbers in the current version.

DECEMBER 2014 – REV.A.2 to REV.A.3	Page
Added SC70-5 Package from product preview to production data	1
Added Ordering Information of SC70-5 package for SGM8925	2
Added SC70-5 package for SGM8925	3
DECEMBER 2013 – REV.A.1 to REV.A.2	Page
Changed Electrical Characteristics section	5
Added input offset voltage (V_{OS}) max value of SGM8925YC5G	5
Changed Electrical Characteristics section	6
Added input offset voltage (V_{OS}) max value of SGM8925YC5G	6
Added output short-circuit current (I_{SC}) min value of SGM8925YC5G	6
Changed output short-circuit current (I_{SC}) min value from 0.4V to 0.3V	6
MAY 2013 – REV.A to REV.A.1	Page
Changed Electrical Characteristics section	5
Deleted open-loop voltage gain (A_{OL}) min value in $R_L = 100k\Omega$ to $V_S/2$ test condition	5
Changed Electrical Characteristics section	6
Deleted open-loop voltage gain (A_{OL}) min value in $R_L = 100k\Omega$ to $V_S/2$ test condition	6
Changes from Original (AUGUST 2012) to REV.A	Page
Changed from product preview to production data	All

PACKAGE OUTLINE DIMENSIONS

SC70-5

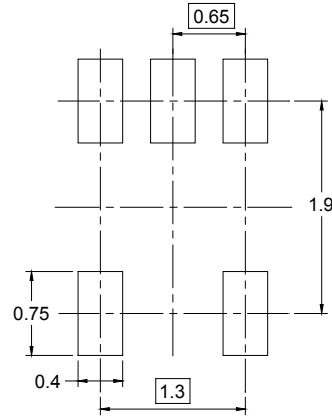
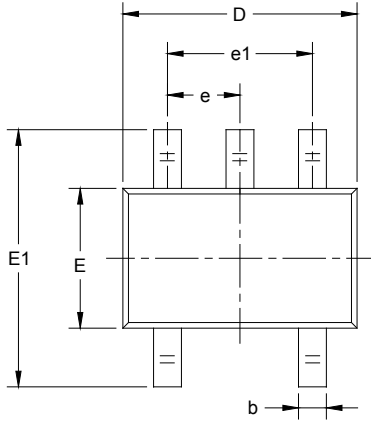

RECOMMENDED LAND PATTERN (Unit: mm)

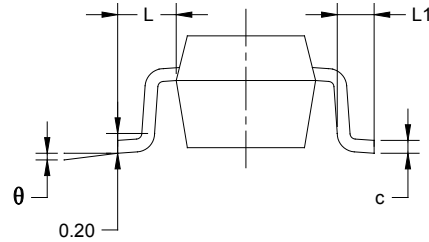
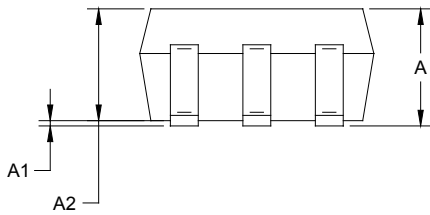

Symbol	Dimensions In Millimeters		Dimensions In Inches	
	MIN	MAX	MIN	MAX
A	0.900	1.100	0.035	0.043
A1	0.000	0.100	0.000	0.004
A2	0.900	1.000	0.035	0.039
b	0.150	0.350	0.006	0.014
c	0.080	0.150	0.003	0.006
D	2.000	2.200	0.079	0.087
E	1.150	1.350	0.045	0.053
E1	2.150	2.450	0.085	0.096
e	0.65 TYP		0.026 TYP	
e1	1.300 BSC		0.051 BSC	
L	0.525 REF		0.021 REF	
L1	0.260	0.460	0.010	0.018
θ	0°	8°	0°	8°

PACKAGE OUTLINE DIMENSIONS

SOT-23-5

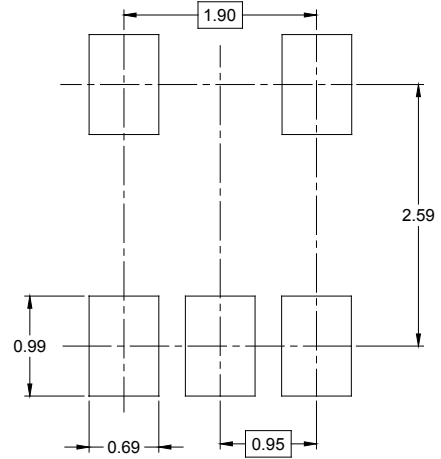

RECOMMENDED LAND PATTERN (Unit: mm)



Symbol	Dimensions In Millimeters		Dimensions In Inches	
	MIN	MAX	MIN	MAX
A	1.050	1.250	0.041	0.049
A1	0.000	0.100	0.000	0.004
A2	1.050	1.150	0.041	0.045
b	0.300	0.500	0.012	0.020
c	0.100	0.200	0.004	0.008
D	2.820	3.020	0.111	0.119
E	1.500	1.700	0.059	0.067
E1	2.650	2.950	0.104	0.116
e	0.950 BSC		0.037 BSC	
e1	1.900 BSC		0.075 BSC	
L	0.300	0.600	0.012	0.024
θ	0°	8°	0°	8°

PACKAGE OUTLINE DIMENSIONS

SOT-23-6

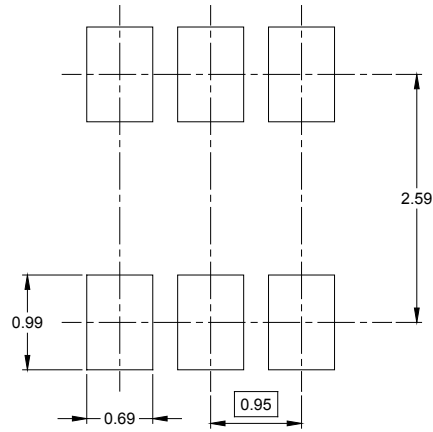
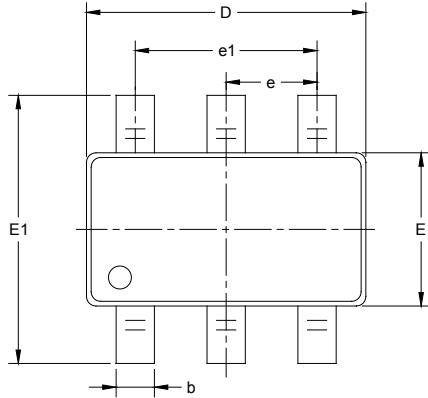

RECOMMENDED LAND PATTERN (Unit: mm)

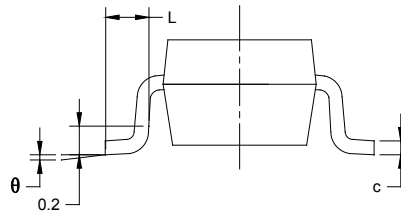
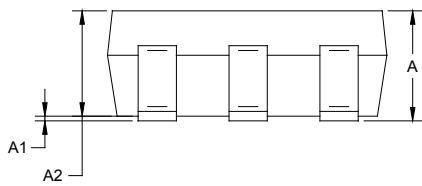

Symbol	Dimensions In Millimeters		Dimensions In Inches	
	MIN	MAX	MIN	MAX
A	1.050	1.250	0.041	0.049
A1	0.000	0.100	0.000	0.004
A2	1.050	1.150	0.041	0.045
b	0.300	0.500	0.012	0.020
c	0.100	0.200	0.004	0.008
D	2.820	3.020	0.111	0.119
E	1.500	1.700	0.059	0.067
E1	2.650	2.950	0.104	0.116
e	0.950 BSC		0.037 BSC	
e1	1.900 BSC		0.075 BSC	
L	0.300	0.600	0.012	0.024
θ	0°	8°	0°	8°

PACKAGE OUTLINE DIMENSIONS

SOIC-8

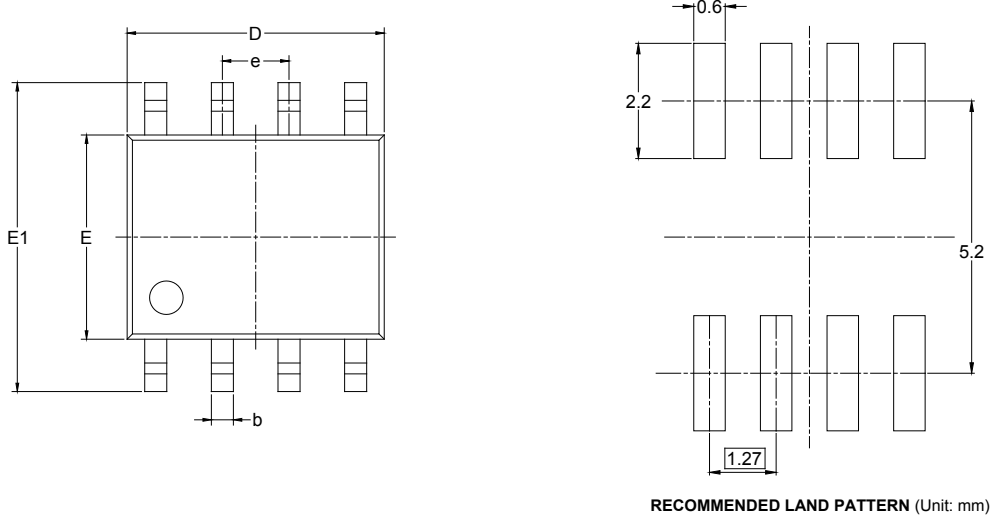

Symbol	Dimensions In Millimeters		Dimensions In Inches	
	MIN	MAX	MIN	MAX
A	1.350	1.750	0.053	0.069
A1	0.100	0.250	0.004	0.010
A2	1.350	1.550	0.053	0.061
b	0.330	0.510	0.013	0.020
c	0.170	0.250	0.006	0.010
D	4.700	5.100	0.185	0.200
E	3.800	4.000	0.150	0.157
E1	5.800	6.200	0.228	0.244
e	1.27 BSC		0.050 BSC	
L	0.400	1.270	0.016	0.050
θ	0°	8°	0°	8°

PACKAGE OUTLINE DIMENSIONS

MSOP-8



RECOMMENDED LAND PATTERN (Unit: mm)

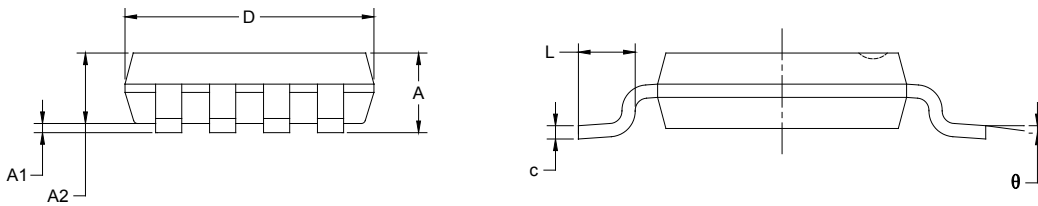

Symbol	Dimensions In Millimeters		Dimensions In Inches	
	MIN	MAX	MIN	MAX
A	0.820	1.100	0.032	0.043
A1	0.020	0.150	0.001	0.006
A2	0.750	0.950	0.030	0.037
b	0.250	0.380	0.010	0.015
c	0.090	0.230	0.004	0.009
D	2.900	3.100	0.114	0.122
E	2.900	3.100	0.114	0.122
E1	4.750	5.050	0.187	0.199
e	0.650 BSC		0.026 BSC	
L	0.400	0.800	0.016	0.031
θ	0°	6°	0°	6°

PACKAGE INFORMATION

TAPE AND REEL INFORMATION

REEL DIMENSIONS



TAPE DIMENSIONS



NOTE: The picture is only for reference. Please make the object as the standard.

KEY PARAMETER LIST OF TAPE AND REEL

Package Type	Reel Diameter	Reel Width W1 (mm)	A0 (mm)	B0 (mm)	K0 (mm)	P0 (mm)	P1 (mm)	P2 (mm)	W (mm)	Pin1 Quadrant
SC70-5	7"	9.5	2.25	2.55	1.20	4.0	4.0	2.0	8.0	Q3
SOT-23-5	7"	9.5	3.20	3.20	1.40	4.0	4.0	2.0	8.0	Q3
SOT-23-6	7"	9.5	3.17	3.23	1.37	4.0	4.0	2.0	8.0	Q3
SOIC-8	13"	12.4	6.40	5.40	2.10	4.0	8.0	2.0	12.0	Q1
MSOP-8	13"	12.4	5.20	3.30	1.50	4.0	8.0	2.0	12.0	Q1

D20001

PACKAGE INFORMATION

CARTON BOX DIMENSIONS



NOTE: The picture is only for reference. Please make the object as the standard.

KEY PARAMETER LIST OF CARTON BOX

Reel Type	Length (mm)	Width (mm)	Height (mm)	Pizza/Carton
7" (Option)	368	227	224	8
7"	442	410	224	18
13"	386	280	370	5

DD0002