

# WS4623C

3A, 19 mΩ, 300nA Quiescent current and 100nA Standby current Load Switch

<https://omnivision-group.com>

## Descriptions

The WS4623C is a single channel load switch with ultra-low on resistance MOSFET. It is designed for load switching applications with ultra-low quiescent current (300nA) and ultra-low standby current (100nA). The device is controlled by external logic pin, allowing optimization of battery life, and portable device autonomy.

The WS4623C contains a P-channel MOSFET that can operate over an input voltage range of 1.2V to 5.5V and can support a maximum continuous current of 3A.

The WS4623C are available in a small 1 x 1.5mm CSP-6L Package. Standard products are Pb-free and Halogen-free.

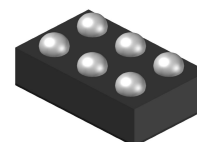

CSP-6L

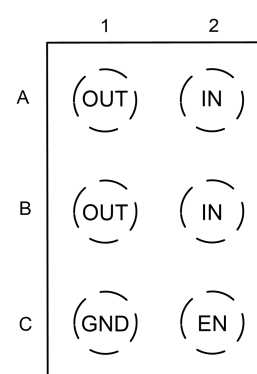

Pin Configuration (Top View)

## Features

- Input Voltage Range : 1.2V~5.5V
- Main switch Ron : 19mΩ @ 4.5V
- Maximum Output current : 3A.
- Quiescent current : 300nA @ Typ
- Standby current : 100nA @ Typ
- Recommend capacitor : 1μF
- Active High EN Pin
- CSP-6L 1 x 1.5 mm

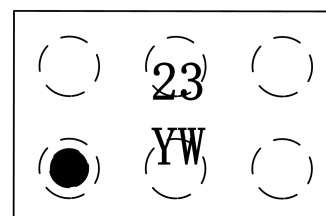

CSP-6L

23 : Device Code

Y : Year code

W : Week code

## Marking

## Applications

- MP3/MP4 Players
- Cellphones, radiophone, digital cameras
- Bluetooth, wireless handsets
- Others portable electronics device

## Order information

Device	Marking	Package	Shipping
WS4623C-6/TR	23YW	CSP-6L	3000/Reel&Tape

Typical Application

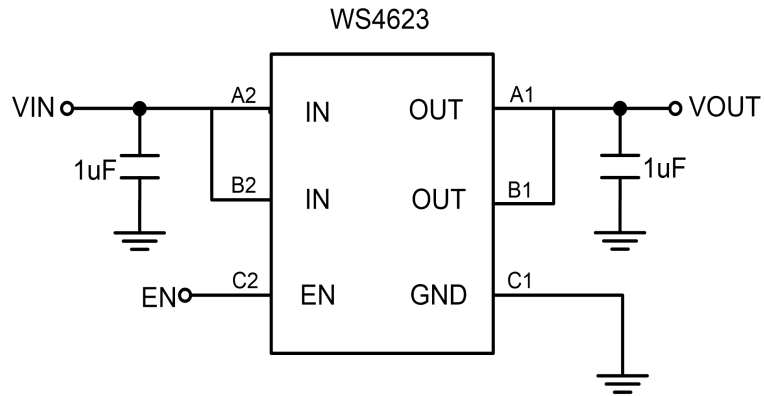

Pin Description

PIN	Symbol	Description
A1, B1	OUT	Output pin
A2, B2	IN	Input pin
C1	GND	Ground
C2	EN	Enable (Active high)

Block Diagram

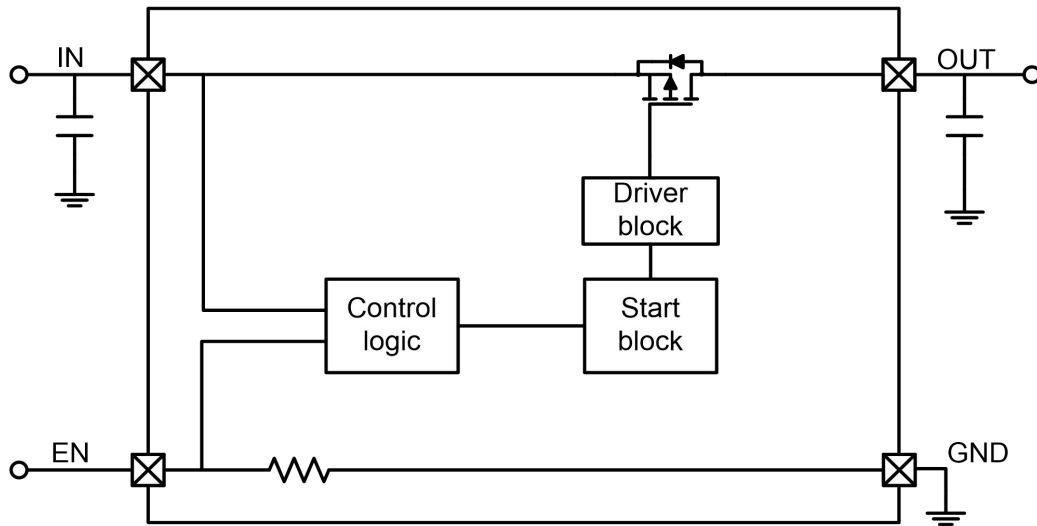

### Absolute Maximum Ratings

Parameter	Value	Unit	
V <sub>IN</sub> Range	-0.3~6.5	V	
V <sub>EN</sub> Range	-0.3~6.5	V	
V <sub>OUT</sub> Range	-0.3~6.5	V	
Storage Temperature Range	-40 ~ 150	°C	
Junction Temperature Range	-40 ~ 125	°C	
Lead Temperature	260	°C	
Moisture Sensitivity	Level-1		
ESD Ratings	HBM	8000	V
	MM	400	V

### Recommend Operating Ratings

Parameter	Value	Unit
Operating Power voltage	1.2~5.5	V
Enable Voltage	0~5.5	V
Maximum DC current	3	A
Operating ambient temperature	-40~85	°C
Operating Junction temperature	-40~125	°C
Decoupling input capacitor	1	uF
Decoupling output capacitor	1	uF
Power Dissipation Rating(25 °C,WLCSP package)	0.66	W
Power Dissipation Rating(85 °C,WLCSP package)	0.26	W
Thermal Resistance, R <sub>θJA</sub> (CSP-6L)	100	°C/W

**Electronics Characteristics (Ta=25°C, VIN=5V, CIN=COUT=1µF, unless otherwise noted)**

Parameter	Symbol	Condition	Min.	Typ.	Max.	Unit
Input Voltage	V <sub>IN</sub>		1.2		5.5	V
Static drain-source on-state resistance	R <sub>DSON</sub>	V <sub>IN</sub> =5.5, I <sub>OUT</sub> =500mA	8	18	23	mΩ
		V <sub>IN</sub> =4.5, I <sub>OUT</sub> =500mA	9	19	26	
		V <sub>IN</sub> =3.3, I <sub>OUT</sub> =500mA	10	21	28	
		V <sub>IN</sub> =1.5, I <sub>OUT</sub> =500mA	12	42	56	
		V <sub>IN</sub> =1.2, I <sub>OUT</sub> =500mA	12	62	200	
EN logic high voltage	V <sub>ENH</sub>		0.9			V
EN logic low voltage	V <sub>ENL</sub>				0.5	V
EN pull down resistor	R <sub>PD</sub>			4		MΩ
Standby current	I <sub>STD</sub>	V <sub>IN</sub> =4.2, EN=Low, No load		100	200	nA
Quiescent current	I <sub>Q</sub>	V <sub>IN</sub> =4.2, EN=High, No load		300	500	nA
Enable time	T <sub>EN</sub>	RL=5ohm		210		µs
Output rise time	T <sub>R</sub>	RL=5ohm		360		µs
ON time(T <sub>EN</sub> +T <sub>R</sub> )	T <sub>ON</sub>	RL=5ohm		570		µs
Output fall time	T <sub>F</sub>	RL=5ohm		16		µs

**TIMINGS**

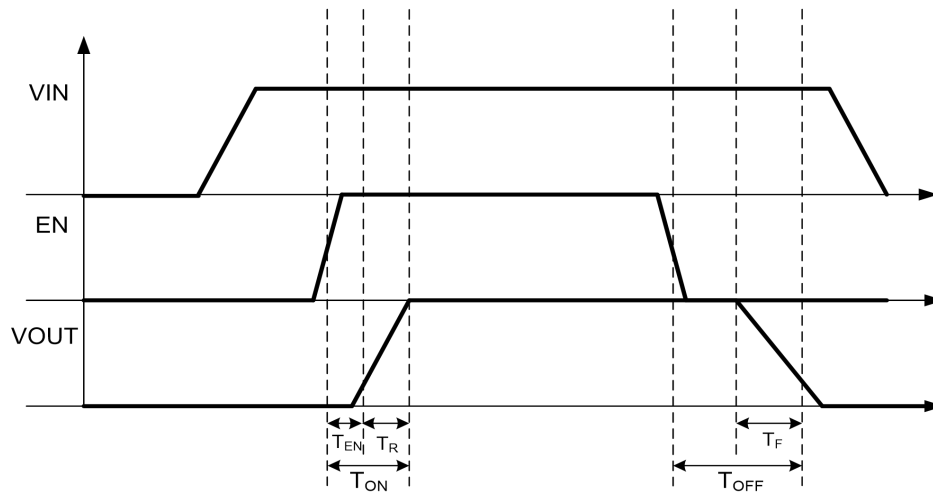

Enable, rise and fall time

Typical characteristics (Ta=25°C, VIN=5V, IOUT=500mA, CIN=COUT=1μF, unless otherwise noted)

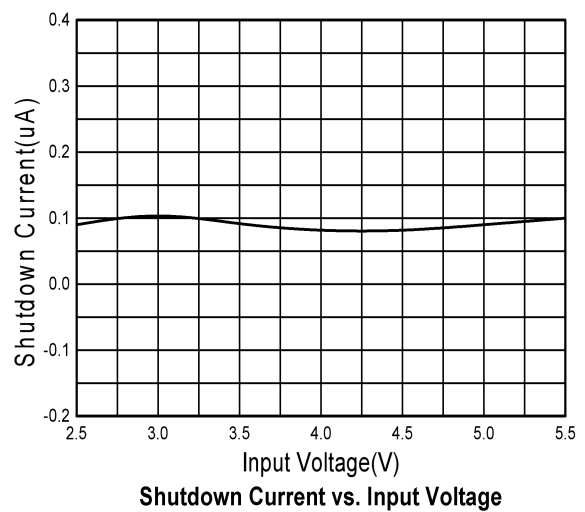
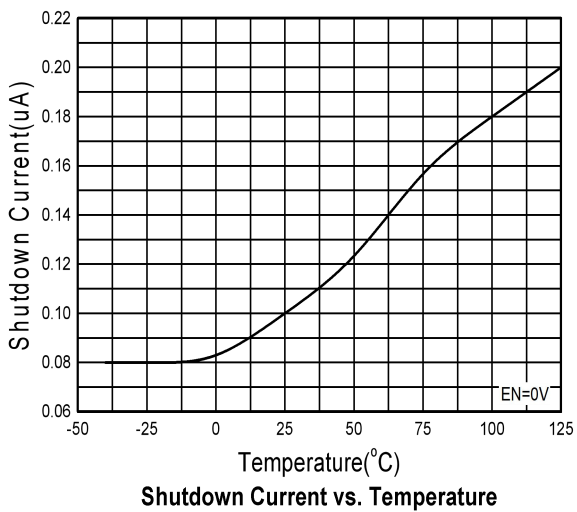
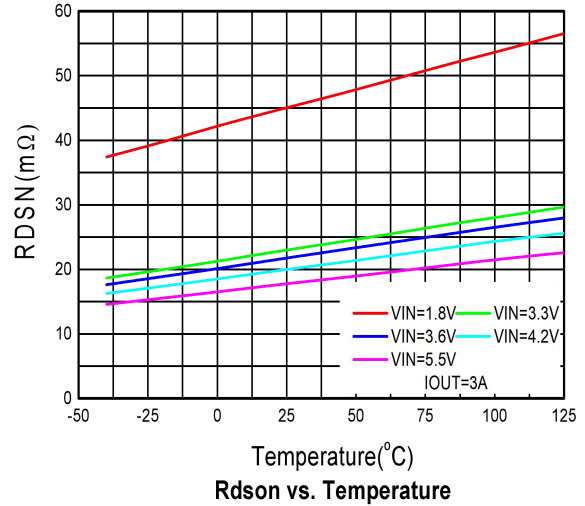
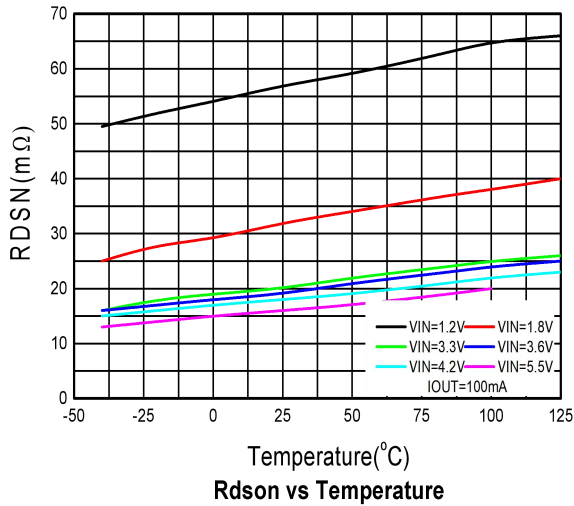
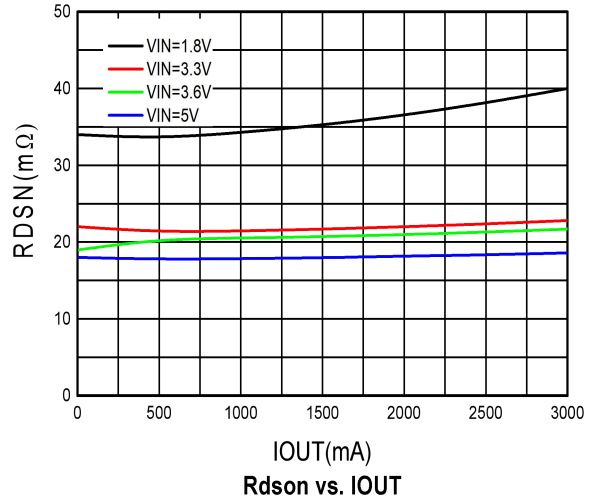
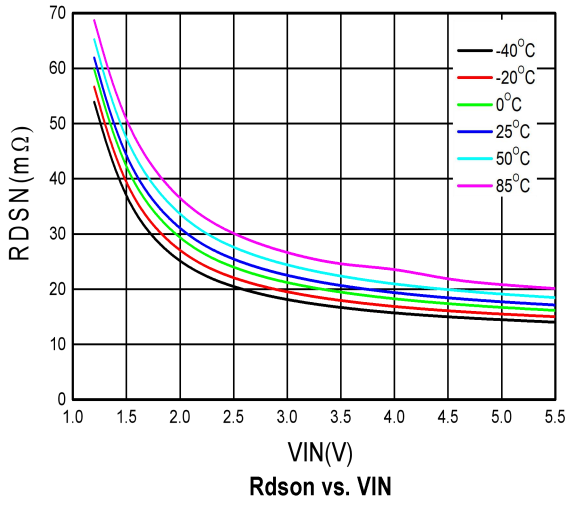

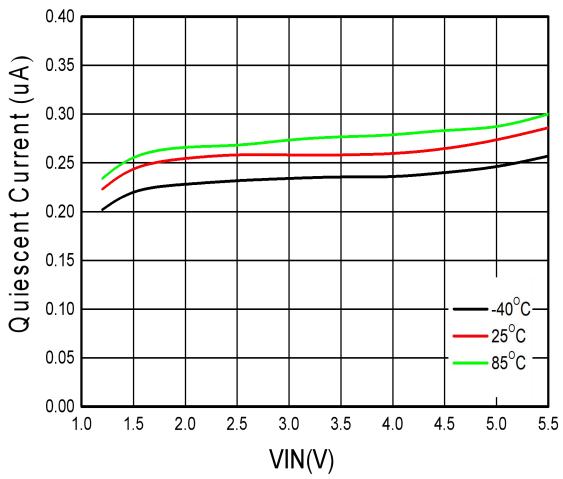

Quiescent Current vs VIN

Turn on transient

Cin=Cout=1uF, no Load

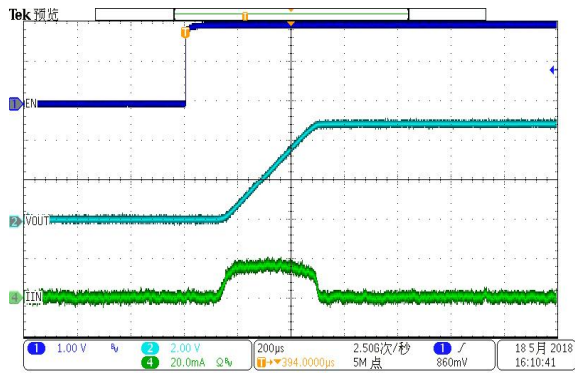

Cin=1uF, Cout=1000uF, no Load

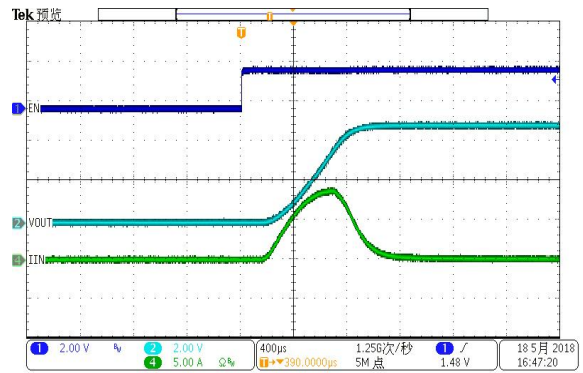

Cin=Cout=1uF, RL=5ohm

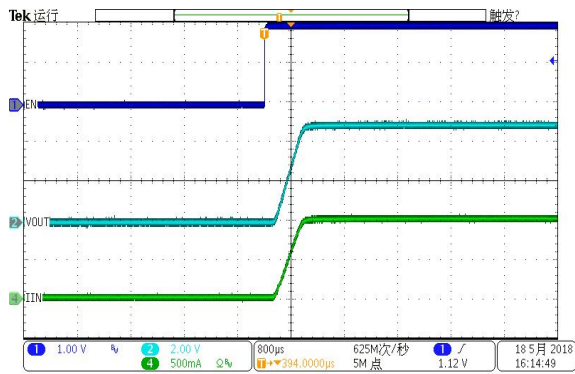

Cin=1uF, Cout=1000uF, RL=5ohm

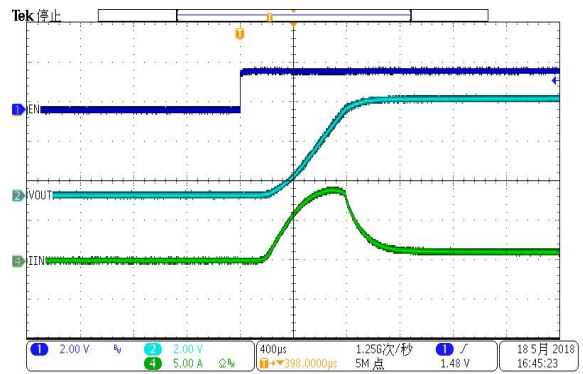

PACKAGE OUTLINE DIMENSIONS

CSP-6L

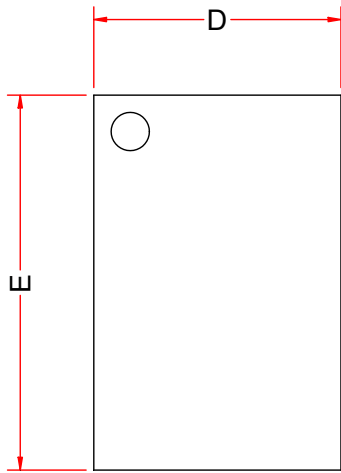

TOP VIEW

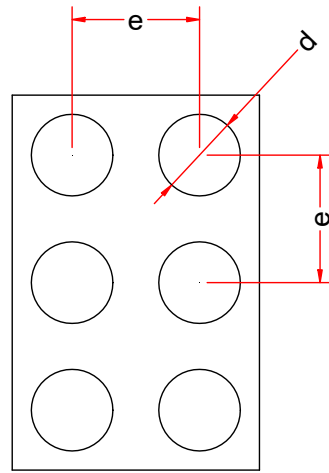

BOTTOM VIEW

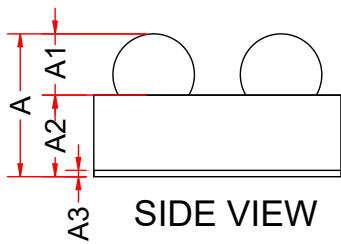

SIDE VIEW

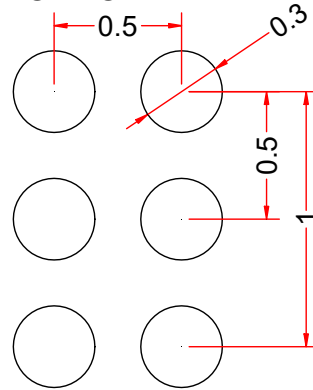

RECOMMENDED LAND PATTERN(Unit:mm)

Symbol	Dimensions in Millimeters		
	Min.	Typ.	Max.
A	0.55	0.58	0.62
A1	0.22	0.24	0.26
A2	0.33	0.34	0.36
A3	0.025		
D	0.94	0.97	1.00
E	1.44	1.47	1.50
e	0.50BSC		
d	0.30	0.32	0.34



**TAPE AND REEL INFORMATION**

**Reel Dimensions**

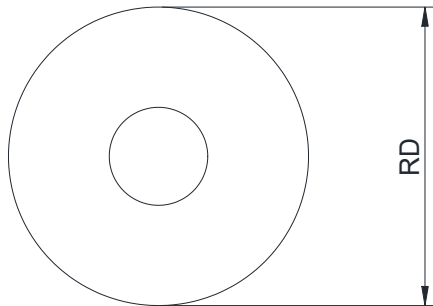

**Tape Dimensions**

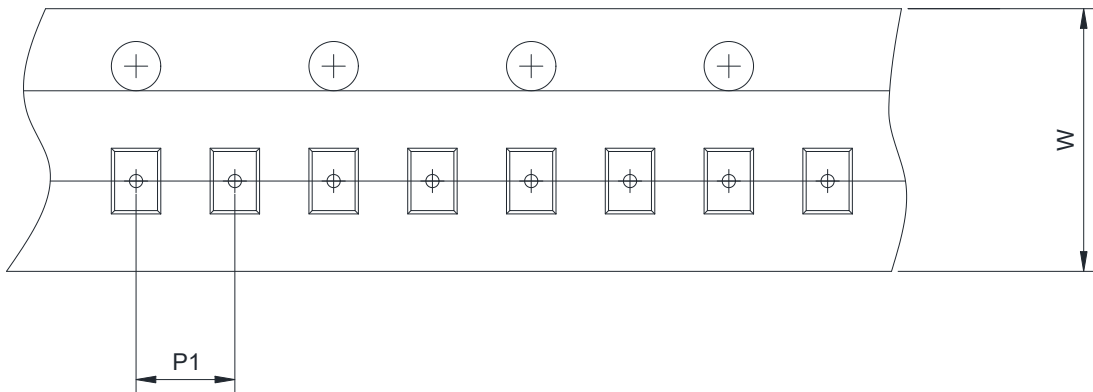

**Quadrant Assignments For PIN1 Orientation In Tape**

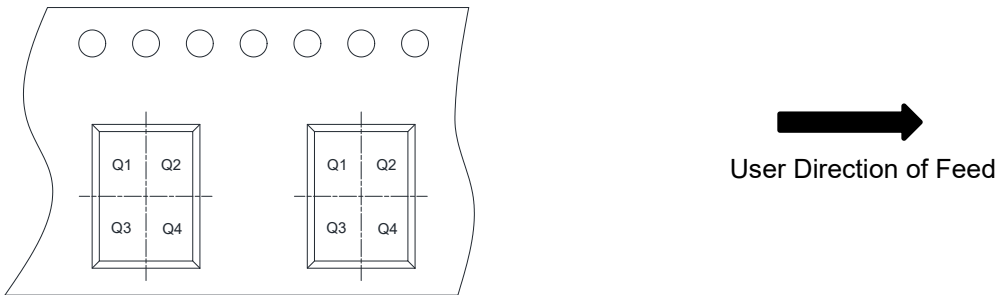

RD	Reel Dimension	<input checked="" type="checkbox"/> 7inch	<input type="checkbox"/> 13inch
W	Overall width of the carrier tape	<input checked="" type="checkbox"/> 8mm	<input type="checkbox"/> 12mm <input type="checkbox"/> 16mm
P1	Pitch between successive cavity centers	<input type="checkbox"/> 2mm	<input checked="" type="checkbox"/> 4mm <input type="checkbox"/> 8mm
Pin1	Pin1 Quadrant	<input checked="" type="checkbox"/> Q1	<input type="checkbox"/> Q2 <input type="checkbox"/> Q3 <input type="checkbox"/> Q4