

# 120mΩ, 2.5A Power Switch with Adjustable Current Limit

## General Description

The RT2528 is a cost effective, low voltage, P-MOSFET power switch IC with an adjustable current limit feature. Low on-resistance (74mΩ typ.) and low supply current (120μA typ.) are designed in this IC.

The RT2528 can offer an adjustable current limit threshold between 0.5A and 2.5A (typ.) via an external resistor. The ±10% current limit accuracy can be realized for all current limit settings.

The RT2528 is an ideal solution for power supply applications since it is functional for various current limit requirements. The RT2528 is available in the thermal enhanced SOP-8 (Exposed Pad) package.

## Ordering Information

RT2528	□	□
	Package Type	
	SP : SOP-8 (Exposed Pad-option 2)	
	Lead Plating System	
	G : Green (Halogen Free and Pb Free)	

Note :

Richtek products are :

- ▶ RoHS compliant and compatible with the current requirements of IPC/JEDEC J-STD-020.
- ▶ Suitable for use in SnPb or Pb-free soldering processes.

## Marking Information

RT2528 GSPYMDNN •	RT2528GSP : Product Number
	YMDNN : Date Code

## Features

- Adjustable Current Limit : 0.5A to 2.5A (typ.)
- ±10% Current Limit Accuracy @ 2A Over Temperature
- 120mΩ P-MOSFET
- Low Supply Current : 120μA
- Input Operating Voltage Range : 2.5V to 5.5V
- Reverse Input-Output Voltage Protection
- Built-in Soft-Start
- AEC-Q100 Grade 3 Qualified
- RoHS Compliant and Halogen Free

## Applications

- Automotive Audio, Navigation & Info Systems
- Industrial Grade General Purpose Point of Load
- Digital Set Top Boxes
- Vehicle Electronics

## Pin Configuration

(TOP VIEW)

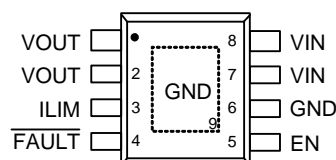

SOP-8 (Exposed Pad)

## Simplified Application Circuit

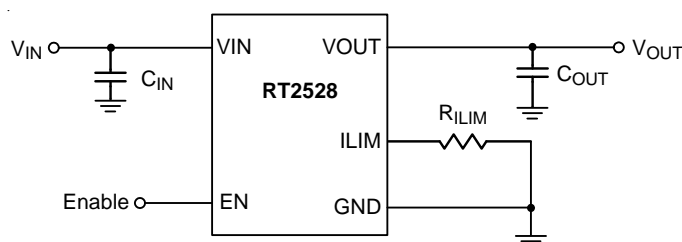

## Functional Pin Description

Pin No.	Pin Name	Pin Function
1, 2	VOUT	Output.
3	ILIM	Current limit setting. Connect an external resistor to set current limit threshold. The recommended resistance range is $10\text{k}\Omega \leq R_{ILIM} \leq 49.9\text{k}\Omega$ .
4	$\overline{\text{FAULT}}$	Active-low open-drain output. Asserted during over-current, over-temperature, or reverse-voltage conditions.
5	EN	Enable control input. Logic high turns on the power switch.
6, 9 (Exposed Pad)	GND	Ground. The exposed pad must be soldered to a large PCB and connected to GND for maximum power dissipation.
7, 8	VIN	Power input. Connect a $10\mu\text{F}$ or greater ceramic capacitor from the VIN to GND as close to the IC as possible.

## Functional Block Diagram

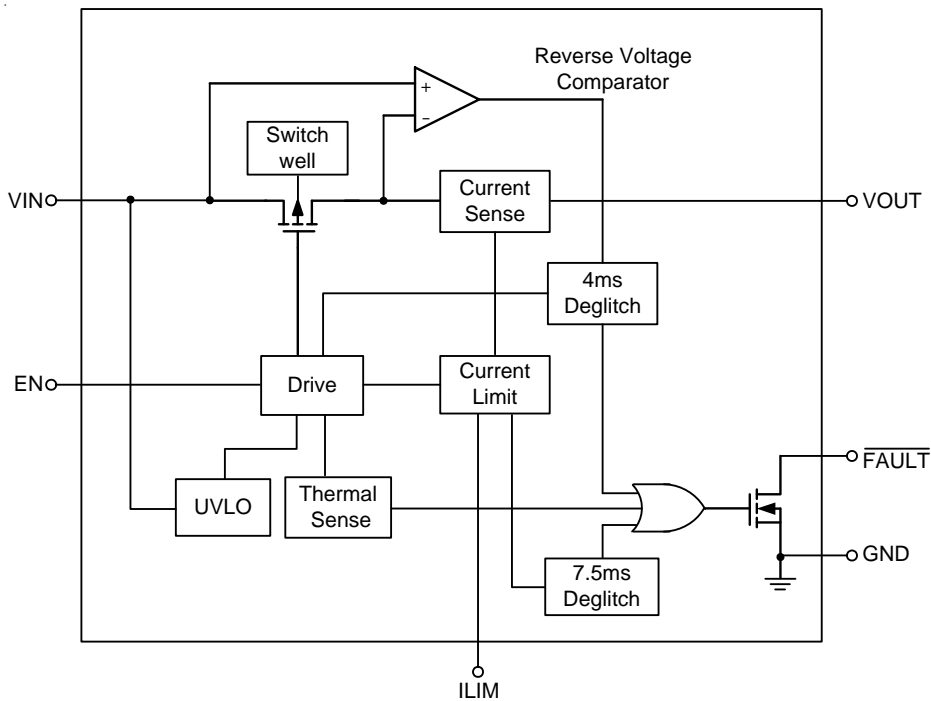

## Operation

The RT2528 is a current-limited power switch using P-MOSFETs for applications where short-circuit or heavy capacitive loads will be encountered. These devices allow users to adjust the current limit threshold between 500mA and 2.5A (typ.) via an external resistor. Additional device shutdown features include over-temperature protection and reverse-voltage protection.

The RT2528 provides built-in soft-start function. The driver controls the gate voltage of the power switch. The driver incorporates circuitry that controls the rising time and falling time of the output voltage to limit large inrush current and voltage surges. The RT2528 enters constant-current mode when the load exceeds the current limit threshold.

## Absolute Maximum Ratings (Note 1)

- Supply Input Voltage,  $V_{IN}$  ----- -0.3V to 6V
- Other Pins ----- -0.3V to 6V
- Power Dissipation,  $P_D$  @  $T_A = 25^\circ\text{C}$   
   SOP-8 (Exposed Pad) ----- 2.041W
- Package Thermal Resistance (Note 2)  
   SOP-8 (Exposed Pad),  $\theta_{JA}$  -----  $49^\circ\text{C/W}$   
   SOP-8 (Exposed Pad),  $\theta_{JC}$  -----  $8^\circ\text{C/W}$
- Lead Temperature (Soldering, 10 sec.) -----  $260^\circ\text{C}$
- Junction Temperature -----  $150^\circ\text{C}$
- Storage Temperature Range -----  $-65^\circ\text{C}$  to  $150^\circ\text{C}$
- ESD Susceptibility (Note 3)  
   HBM (Human Body Model) ----- 2kV

## Recommended Operating Conditions (Note 4)

- Supply Input Voltage,  $V_{IN}$  ----- 2.5V to 5.5V
- Temperature Range Junction -----  $-40^\circ\text{C}$  to  $125^\circ\text{C}$
- Ambient Temperature Range -----  $-40^\circ\text{C}$  to  $85^\circ\text{C}$

## Electrical Characteristics

( $V_{IN} = 5\text{V}$ ,  $T_A = T_J = -40^\circ\text{C}$  to  $85^\circ\text{C}$ , unless otherwise specified)

Parameter		Symbol	Test Conditions	Min	Typ	Max	Unit
Shutdown Current		$I_{SHDN}$	$V_{EN} = 0\text{V}$ , $I_{OUT} = 0\text{A}$	--	1	5	$\mu\text{A}$
Quiescent Current		$I_Q$	$I_{OUT} = 0\text{A}$	--	120	300	$\mu\text{A}$
EN Input Voltage	Logic-High	$V_{IH}$		1.2	--	--	V
	Logic-Low	$V_{IL}$		--	--	0.4	
EN Input Current		$I_{EN}$	$V_{IN} = 5.5\text{V}$ $V_{EN} = 0\text{V}$ or $5.5\text{V}$	--	0.02	0.5	$\mu\text{A}$
Current Limit Setting Resistor Range		$R_{ILIM}$		10	--	65	$\text{k}\Omega$
Reverse Leakage Current		$I_{REV}$	$V_{OUT} = 5\text{V}$ , $V_{IN} = 0\text{V}$	--	1	10	$\mu\text{A}$
Thermal Shutdown Threshold		$T_{SD}$		--	160	--	$^\circ\text{C}$
Static Drain-Source On-State Resistance		$R_{DS(ON)}$	$I_{OUT} = 0.2\text{A}$	--	74	120	$\text{m}\Omega$
Reverse Voltage Comparator Trip Point		$I_{REV\_HYS}$	$V_{OUT} - V_{IN}$	100	135	300	mV
Current Limit		$I_{LIM}$	$R_{ILIM} = 13\text{k}\Omega$	1800	2000	2200	mA
			$R_{ILIM} = 13\text{k}\Omega$ , $T_A = 25^\circ\text{C}$	1840	2000	2160	
			$R_{ILIM} = 49.9\text{k}\Omega$	468	520	572	
FAULT Deglitch			FAULT assertion or de-assertion due to over-current condition	2	7.5	14	ms

# RT2528

---

**Note 1.** Stresses beyond those listed “Absolute Maximum Ratings” may cause permanent damage to the device. These are stress ratings only, and functional operation of the device at these or any other conditions beyond those indicated in the operational sections of the specifications is not implied. Exposure to absolute maximum rating conditions may affect device reliability.

**Note 2.**  $\theta_{JA}$  is measured at  $T_A = 25^\circ\text{C}$  on a high effective thermal conductivity four-layer test board per JEDEC 51-7.  $\theta_{JC}$  is measured at the exposed pad of the package. The PCB copper area with exposed pad is  $70\text{mm}^2$ .

**Note 3.** Devices are ESD sensitive. Handling precaution is recommended.

**Note 4.** The device is not guaranteed to function outside its operating conditions.

Typical Application Circuit

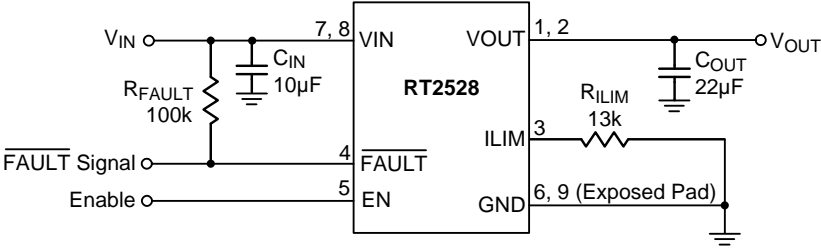

Note :  $R_{LIM} = 13k\Omega$  for 2A Power Switch Operation

# RT2528

## Typical Operating Characteristics

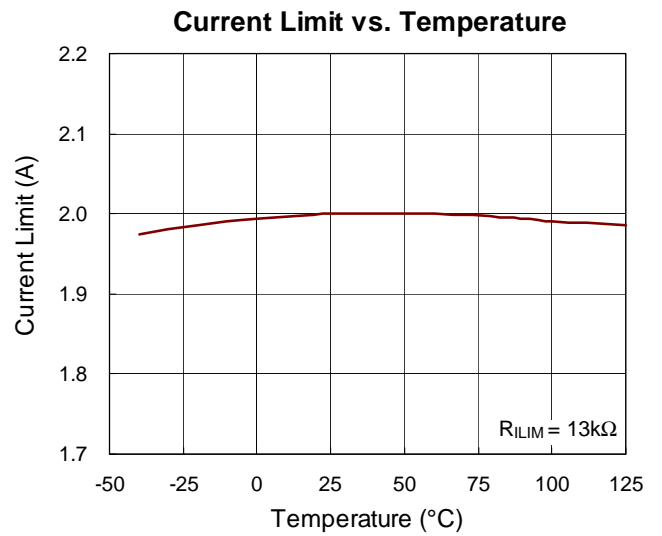
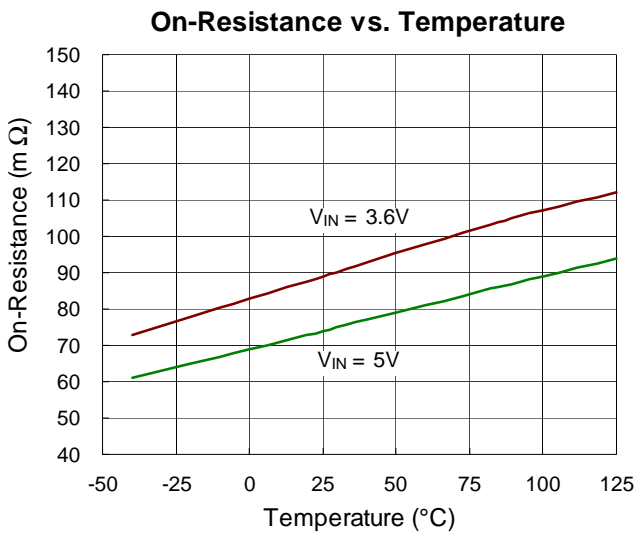
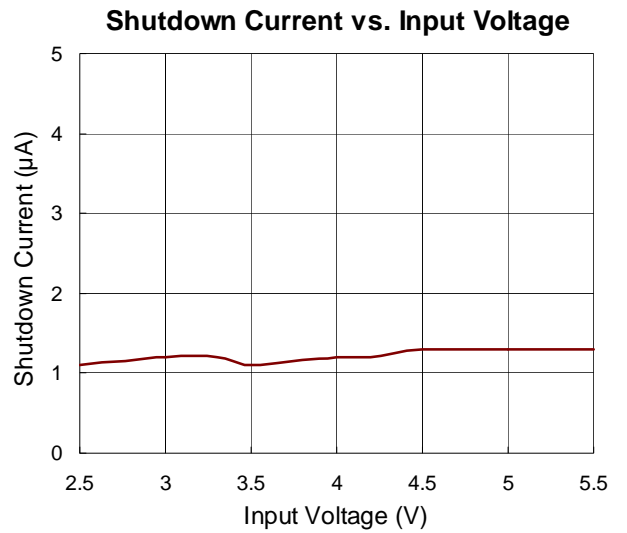
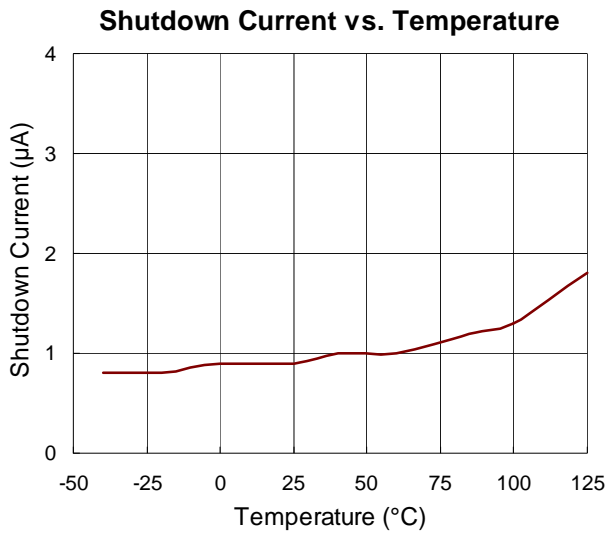
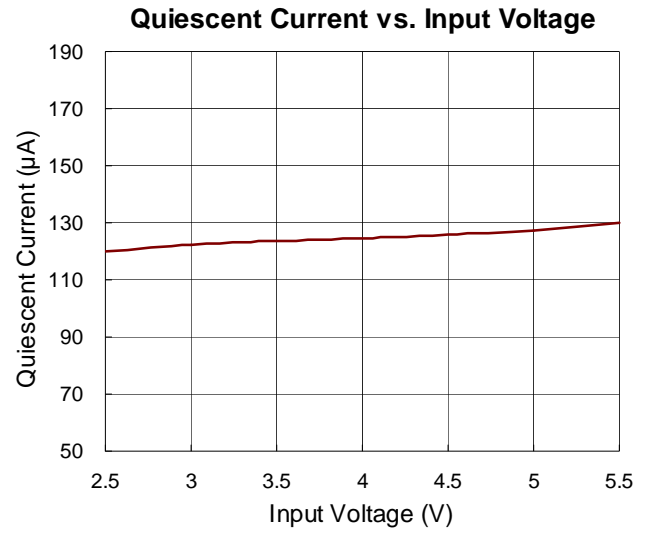
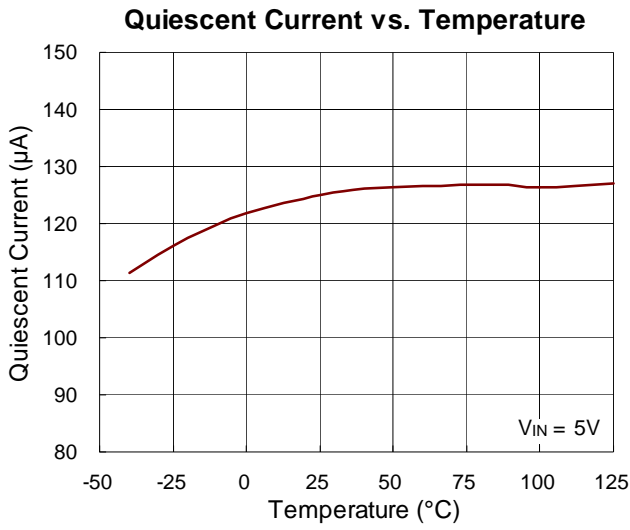

EN Threshold Voltage vs. Temperature

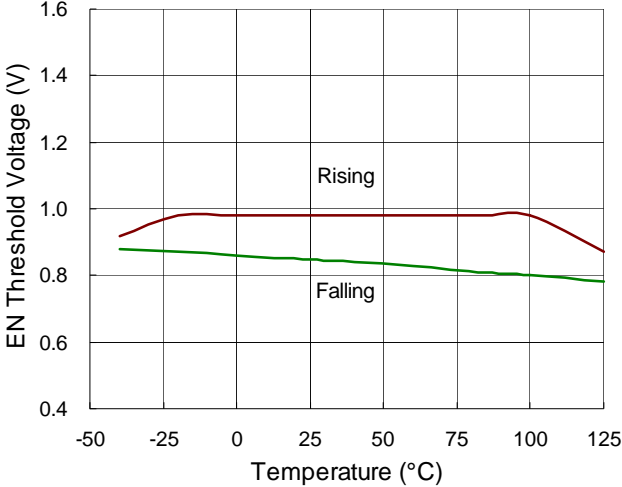

UVLO vs. Temperature

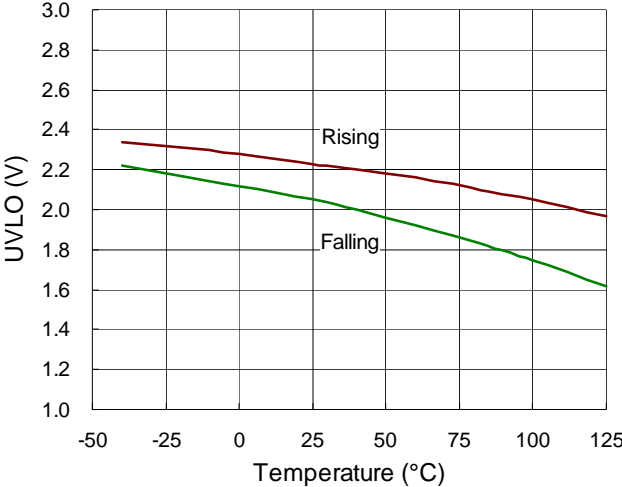

Power On from EN

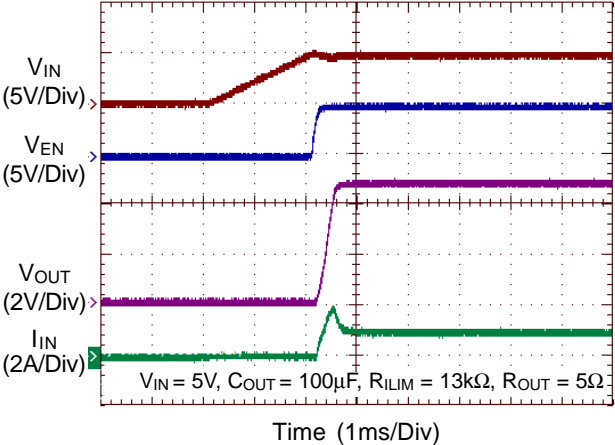

Power Off from EN

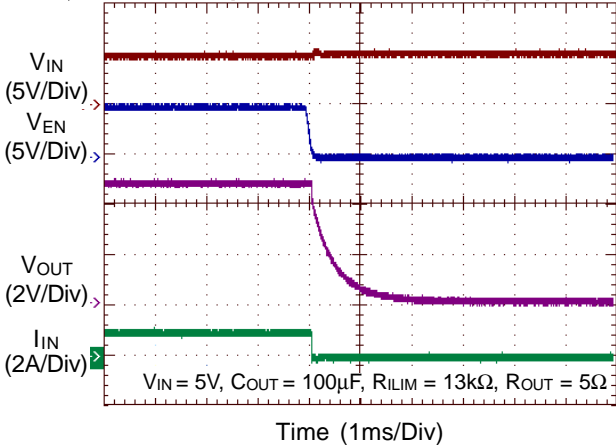

Short Circuit Protection

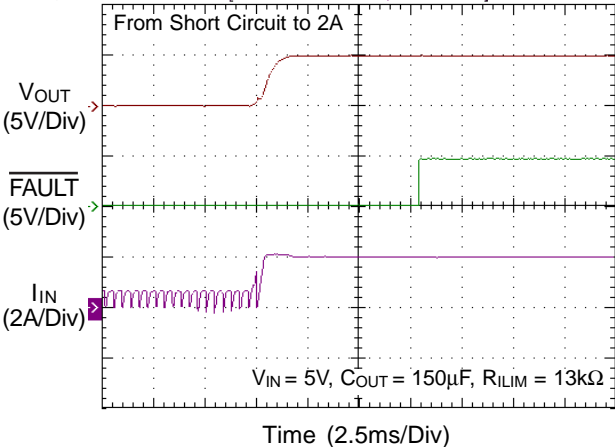

Short Circuit Protection

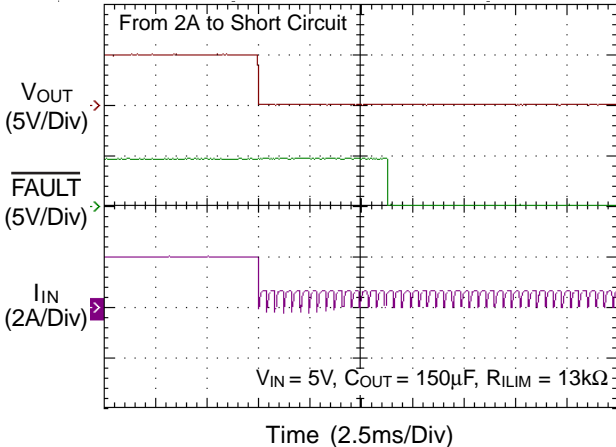

## Short Circuit Protection

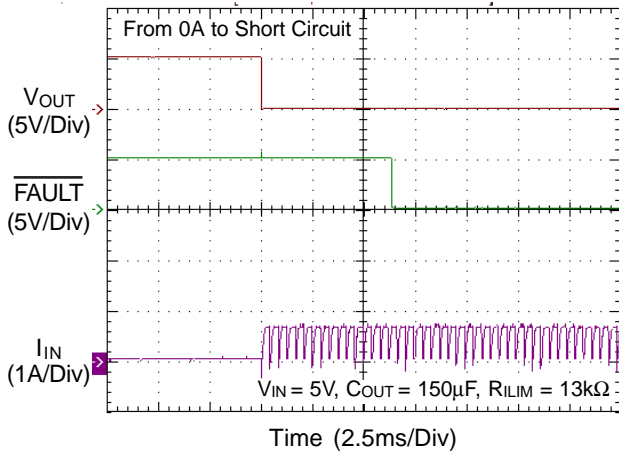

## Short Circuit Protection

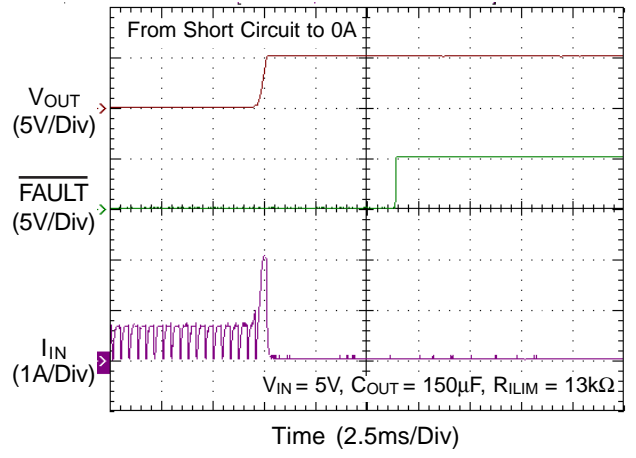

## Current Limit Threshold vs. ( $V_{IN} - V_{OUT}$ )

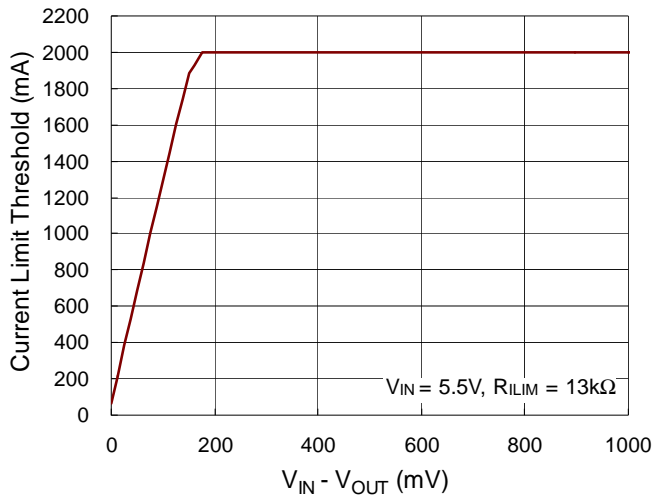

## Current Limit Threshold vs. ( $V_{IN} - V_{OUT}$ )

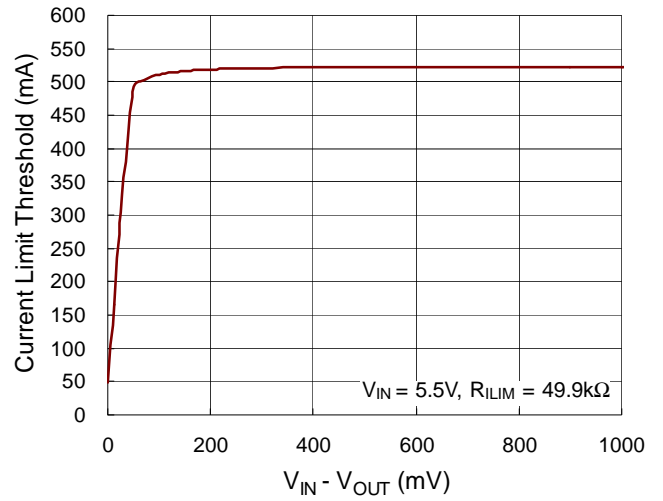



## Application Information

The RT2528 is a single P-MOSFET high side power switch with active high enable input, optimized for self powered and bus powered Universal Serial Bus (USB) applications. The switch's low  $R_{DS(ON)}$  meets USB voltage drop requirements and a flag output is available to indicate fault conditions to the local USB controller.

### Current Limiting and Short Circuit Protection

When a heavy load or short circuit situation occurs while the switch is enabled, large transient current may flow through the device. The RT2528 includes a current limit circuitry to prevent these large currents from damaging the MOSFET switch and the hub downstream ports. The RT2528 provides an adjustable current limit threshold between 0.5A and 2.5A (typ.) via an external resistor,  $R_{ILIM}$ , between 10k $\Omega$  and 49.9k $\Omega$ . Once the current limit threshold is exceeded, and output voltage doesn't drop over 1/2 input voltage, the device enters constant current mode.

If output voltage drops under around 1/2 input voltage, the device enters re-soft start current fold-back mode until either thermal shutdown occurs or the fault is removed. The Table1 shows a recommended current limit value vs.  $R_{ILIM}$  resistor.

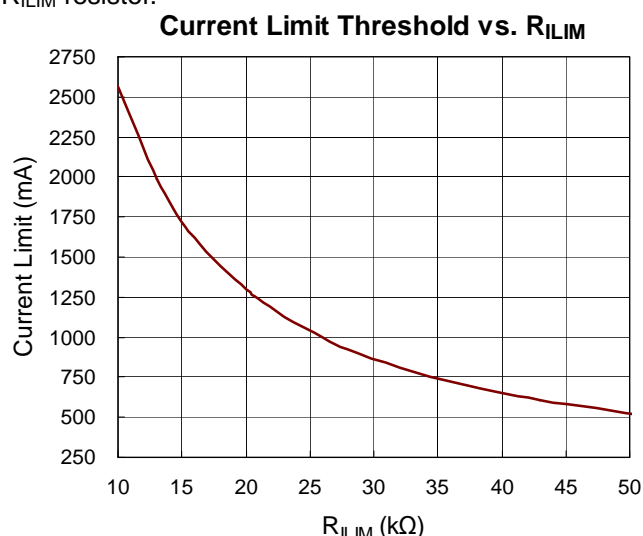

Figure 1. Current Limit Threshold vs.  $R_{ILIM}$

**Table 1. Recommended  $R_{ILIM}$  Resistor Selections**

Desired Nominal Current Limit (mA)	Ideal Resistor (k $\Omega$ )	Closest 1% Resistor (k $\Omega$ )	Actual Limits (Include R Tolerance)		
			IOS min (mA)	IOS nom (mA)	IOS max (mA)
500	52.5	52.3	443.9	501.6	562.4
600	43.5	43.2	535.1	604.6	674.1
700	37.2	37.4	616.0	696.0	776.0
800	32.4	32.4	708.7	800.8	892.9
900	28.7	28.7	797.8	901.5	1005.2
1000	25.8	26.1	875.4	989.1	1102.8
1100	23.4	23.2	982.1	1109.7	1237.3
1200	21.4	21.5	1057.9	1195.4	1332.9
1300	19.7	19.6	1158.0	1308.5	1459.0
1400	18.5	18.7	1225.7	1385.0	1544.3
1500	17.3	17.4	1317.3	1488.5	1659.7
1600	16.2	16.2	1414.8	1598.7	1782.6
1700	15.2	15.0	1528.1	1726.7	1925.3
1800	14.4	14.3	1602.9	1811.2	2019.5
1900	13.6	13.7	1673.1	1890.5	2107.9
2000	12.9	13.0	1763.2	1992.3	2221.4
2100	12.3	12.4	1848.5	2088.7	2328.9
2200	11.8	11.8	1942.6	2195.0	2447.4
2300	11.3	11.3	2028.4	2292.0	2555.6
2400	10.8	10.7	2141.7	2420.0	2698.3
2500	10.3	10.0	2292.2	2590.0	2887.9

# RT2528

---

## Fault Flag

The RT2528 provides a  $\overline{\text{FAULT}}$  signal pin which is an N-Channel open drain MOSFET output. This open drain output goes low when current exceeds current limit threshold. The  $\overline{\text{FAULT}}$  output is capable of sinking a 1mA load to typically 180mV above ground. The  $\overline{\text{FAULT}}$  pin requires a pull-up resistor ; this resistor should be large in value to reduce energy drain. A 100k $\Omega$  pull-up resistor works well for most applications. In case of an over current condition,  $\overline{\text{FAULT}}$  will be asserted only after the flag response delay time,  $t_D$ , has elapsed. This ensures that  $\overline{\text{FAULT}}$  is asserted upon valid over current conditions and that erroneous error reporting is eliminated. For example, false over current conditions may occur during hot-plug events when extremely large capacitive loads are connected, which induces a high transient inrush current that exceeds the current limit threshold. The  $\overline{\text{FAULT}}$  response delay time,  $t_D$ , is typically 7.5ms.

## Supply Filter/Bypass Capacitor

A 10 $\mu$ F low-ESR ceramic capacitor connected from VIN to GND and located close to the device is strongly recommended to prevent input voltage drooping during hotplug events. However, higher capacitor values may be used to further reduce the voltage droop on the input. Without this bypass capacitor, an output short may cause sufficient ringing on the input (from source lead inductance) to destroy the internal control circuitry. Note that the input transient voltage must never exceed 6V as stated in the Absolute Maximum Ratings.

## Output Filter Capacitor

A low-ESR 22 $\mu$ F ceramic capacitor connected between VOUT and GND is strongly recommended to meet the USB standard maximum droop requirement for the hub, VBUS. Standard bypass methods should be used to minimize inductance and resistance between the bypass capacitor and the downstream connector to reduce EMI and decouple voltage droop caused by hot-insertion transients in downstream cables. Ferrite beads in series with VBUS, the ground line and the 0.1 $\mu$ F bypass capacitors at the power connector pins are recommended for EMI and ESD protection. The bypass capacitor itself

should have a low dissipation factor to allow decoupling at higher frequencies.

## Chip Enable Input

The RT2528 don't have auto discharge function. During shutdown condition, the supply current is 1 $\mu$ A typical. The maximum guaranteed voltage for a logic-low at the EN pin is 0.4V. A minimum guaranteed voltage of 1.2V at the EN pin will turn on the RT2528. Floating the input may cause unpredictable operation. The EN signal must be asserted after input voltage ready or higher than UVLO threshold to satisfy the power sequence.

## Under-Voltage Lockout

Under-Voltage Lockout (UVLO) prevents the MOSFET switch from turning on until input voltage exceeds approximately 2.2V. If input voltage drops below approximately 2V, UVLO turns off the MOSFET switch.

## Thermal Considerations

For continuous operation, do not exceed absolute maximum junction temperature. The maximum power dissipation depends on the thermal resistance of the IC package, PCB layout, rate of surrounding airflow, and difference between junction and ambient temperature. The maximum power dissipation can be calculated by the following formula :

$$P_{D(\text{MAX})} = (T_{J(\text{MAX})} - T_A) / \theta_{JA}$$

where  $T_{J(\text{MAX})}$  is the maximum junction temperature,  $T_A$  is the ambient temperature, and  $\theta_{JA}$  is the junction to ambient thermal resistance.

For recommended operating condition specifications, the maximum junction temperature is 125 $^{\circ}$ C. The junction to ambient thermal resistance,  $\theta_{JA}$ , is layout dependent. For SOP-8 (Exposed Pad) package, the thermal resistance,  $\theta_{JA}$ , is 49 $^{\circ}$ C/W on a standard JEDEC 51-7 four-layer thermal test board. The maximum power dissipation at  $T_A = 25^{\circ}$ C can be calculated by the following formula :

$$P_{D(\text{MAX})} = (125^{\circ}\text{C} - 25^{\circ}\text{C}) / (49^{\circ}\text{C/W}) = 2.041\text{W for SOP-8 (Exposed Pad) package}$$

The maximum power dissipation depends on the operating ambient temperature for fixed  $T_{J(MAX)}$  and thermal resistance,  $\theta_{JA}$ . The derating curve in Figure 2 allows the designer to see the effect of rising ambient temperature on the maximum power dissipation.

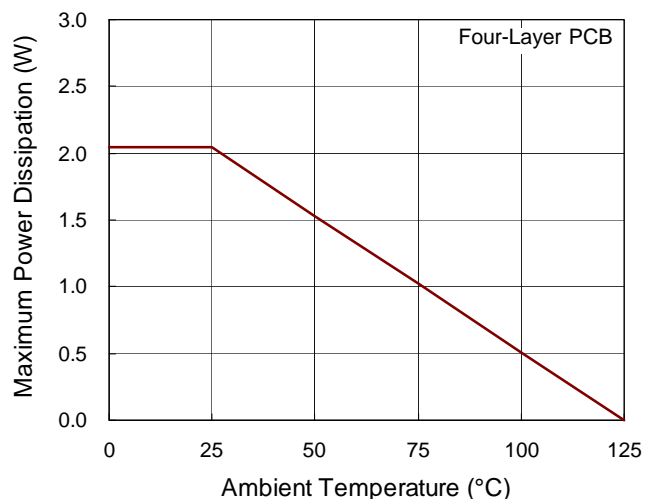
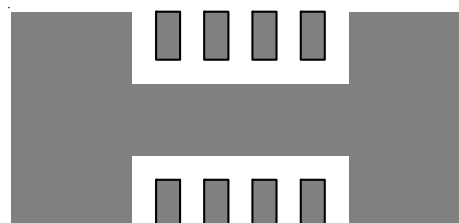

Figure 2. Derating Curve of Maximum Power Dissipation

## Layout Consideration

- ▶ Ounce copper on top layer will improve thermal performance. 4-layer PCB will be better.
- ▶ Place the shape with minimum 70mm<sup>2</sup> as Figure 3 around the SOP-8 (Exposed Pad) footprint to achieve best thermal performance.



Copper Area = 70mm<sup>2</sup>,  $\theta_{JA} = 49^{\circ}\text{C/W}$

Figure 3. PCB Copper Area

- ▶ Utilize standard PTH (Plated Through Hole, 25mil diameter, as Figure 4) to Via down from exposed pad on top layer to GND plane on other layers.

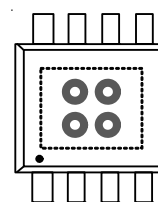
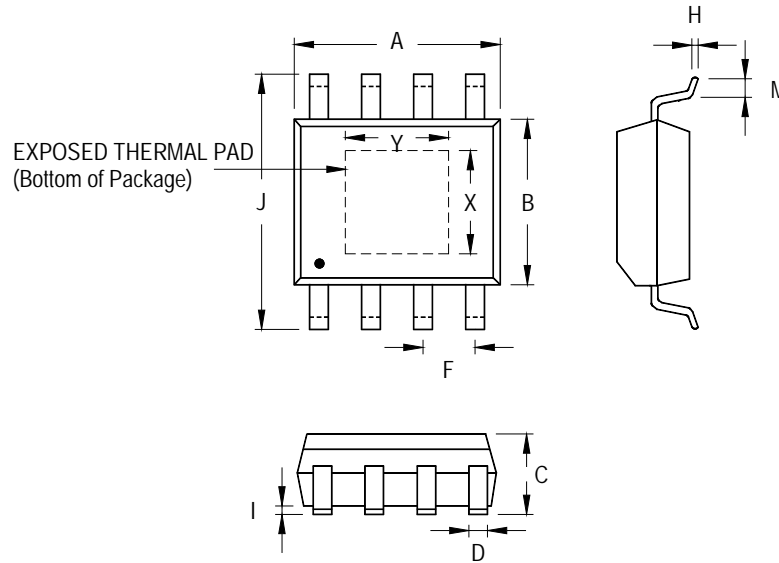

Figure 4. Standard PTH to GND Plane

# RT2528

## Outline Dimension



Symbol	Dimensions In Millimeters		Dimensions In Inches		
	Min	Max	Min	Max	
A	4.801	5.004	0.189	0.197	
B	3.810	4.000	0.150	0.157	
C	1.346	1.753	0.053	0.069	
D	0.330	0.510	0.013	0.020	
F	1.194	1.346	0.047	0.053	
H	0.170	0.254	0.007	0.010	
I	0.000	0.152	0.000	0.006	
J	5.791	6.200	0.228	0.244	
M	0.406	1.270	0.016	0.050	
Option 1	X	2.000	2.300	0.079	0.091
	Y	2.000	2.300	0.079	0.091
Option 2	X	2.100	2.500	0.083	0.098
	Y	3.000	3.500	0.118	0.138

**8-Lead SOP (Exposed Pad) Plastic Package**

### Richtek Technology Corporation

14F, No. 8, Tai Yuen 1<sup>st</sup> Street, Chupei City

Hsinchu, Taiwan, R.O.C.

Tel: (8863)5526789

Richtek products are sold by description only. Customers should obtain the latest relevant information and data sheets before placing orders and should verify that such information is current and complete. Richtek cannot assume responsibility for use of any circuitry other than circuitry entirely embodied in a Richtek product. Information furnished by Richtek is believed to be accurate and reliable. However, no responsibility is assumed by Richtek or its subsidiaries for its use; nor for any infringements of patents or other rights of third parties which may result from its use. No license is granted by implication or otherwise under any patent or patent rights of Richtek or its subsidiaries.