

**GENERAL DESCRIPTION**

The SPX29300/01/02 are 3A, highly accurate voltage regulators with a low dropout voltage of 600mV (typical) at 3A.

These regulators are specifically designed for low voltage applications that require a low dropout voltage and a fast transient response. They are fully fault protected against over-current, reverse battery, and positive and negative voltage transients. On-Chip trimming adjusts the reference voltage to 1% initial accuracy.

The SPX29300 is offered in a 3-pin TO-263 package, the SPX29301 and SPX29302 are offered in a 5-pin TO-263 package.

**APPLICATIONS**

- Adjustable Power Supplies
- Constant Current Regulators
- Audio and Video/Graphic Cards
- Battery Chargers

**FEATURES**

- 3A Guaranteed Output Current
- Low Dropout Voltage of 600mV @ 3A
- Adjustable Output down to 1.25V
- 1% Output Accuracy
- Tight Load and Line Regulation
- Fast Transient Response
- Reverse Battery Protection
- Zero Current Shutdown (SPX29301/02)
- Power Good Flag (SPX29301)
- Lead Free 3-Pin TO-263 and 5-pin TO-263 Packages

**TYPICAL APPLICATION DIAGRAM**

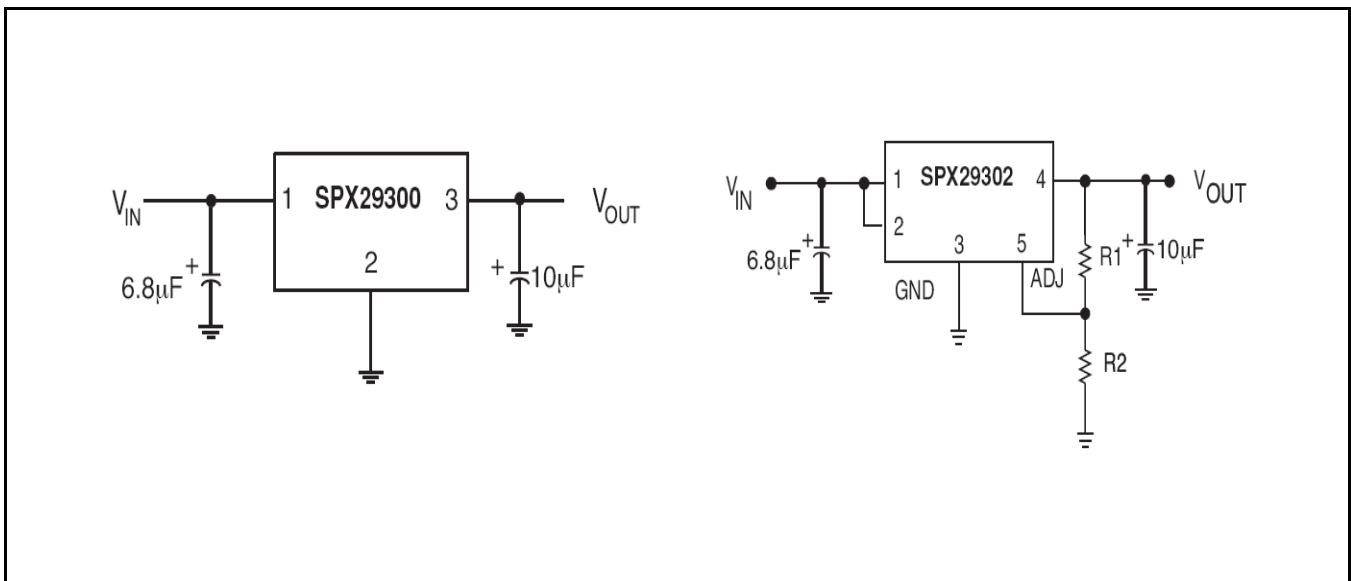

Fig. 1: SPX29300 and SPX29302 Application Diagrams

**ABSOLUTE MAXIMUM RATINGS**

These are stress ratings only and functional operation of the device at these ratings or any other above those indicated in the operation sections of the specifications below is not implied. Exposure to absolute maximum rating conditions for extended periods of time may affect reliability.

Input Voltage $V_{IN}^1$ .....	20V
Storage Temperature.....	-65°C to 150°C
Lead Temperature (Soldering, 5 sec).....	260°C
ESD Rating (HBM - Human Body Model).....	
All pins except EN.....	2kV
En pin.....	1kV

**OPERATING RATINGS**

Input Voltage Range $V_{IN}$ .....	16V
Junction Temperature Range.....	-40°C to 125°C
Thermal Resistance.....	
TO-263-3 Junction to Ambient.....	31.4°C/W
TO-263-5 Junction to Ambient.....	31.2°C/W
TO-263-3, TO-263-5 Junction to Case.....	3°C/W

Note 1: Maximum positive supply voltage of 20V must be of limited duration (<100ms) and duty cycle of less than 1%. The maximum continuous supply voltage is 16V.

**ELECTRICAL SPECIFICATIONS**

Specifications with standard type are for an Operating Junction Temperature of  $T_J = T_A = 25^\circ\text{C}$  only; limits applying over the full Operating Junction Temperature range are denoted by a “\*”. Minimum and Maximum limits are guaranteed through test, design, or statistical correlation. Typical values represent the most likely parametric norm at  $T_J = 25^\circ\text{C}$ , and are provided for reference purposes only. Unless otherwise indicated,  $V_{IN} = V_{OUT} + 1\text{V}$  and  $I_{OUT} = 10\text{mA}$ ,  $C_{IN} = 6.8\mu\text{F}$ ,  $C_{OUT} = 10\mu\text{F}$ ,  $T_A = 25^\circ\text{C}$ .

Parameter	Min.	Typ.	Max.	Units	Conditions
<b>Fixed Voltage Versions</b>					
Output Voltage, 1.8V Version	1.782	1.800	1.818	V	$I_{OUT} = 10\text{mA}$
	1.764	1.800	1.836		• $10\text{mA} \leq I_{OUT} \leq 3\text{A}$ , $2.8\text{V} \leq V_{IN} \leq 16\text{V}$
Output Voltage, 2.5V Version	2.475	2.500	2.525	V	$I_{OUT} = 10\text{mA}$
	2.450	2.500	2.550		• $10\text{mA} \leq I_{OUT} \leq 3\text{A}$ , $3.5\text{V} \leq V_{IN} \leq 16\text{V}$
Output Voltage, 3.3V Version	3.267	3.300	3.333	V	$I_{OUT} = 10\text{mA}$
	3.234	3.300	3.366		• $10\text{mA} \leq I_{OUT} \leq 3\text{A}$ , $4.3\text{V} \leq V_{IN} \leq 16\text{V}$
Output Voltage, 5.0V Version	4.950	5.000	5.050	V	$I_{OUT} = 10\text{mA}$
	4.900	5.000	5.100		• $10\text{mA} \leq I_{OUT} \leq 3\text{A}$ , $6.0\text{V} \leq V_{IN} \leq 16\text{V}$
<b>All Voltage Versions</b>					
Line Regulation		0.06	0.5	%	$I_{OUT} = 10\text{mA}$ , $(V_{OUT} + 1\text{V}) \leq V_{IN} \leq 16\text{V}$
Load Regulation		0.2	1	%	$V_{IN} = V_{OUT} + 1\text{V}$ , $10\text{mA} \leq I_{OUT} \leq I_{FL}$ (note 2)
$\Delta V/\Delta T$		20	100	ppm/ $^\circ\text{C}$	• $V_{OUT}$ Temp Coefficient (note 6)
Dropout Voltage Except 1.8V Version (note 3)		120	300	mV	• $I_{OUT} = 100\text{mA}$
		380			$I_{OUT} = 1.5\text{A}$
		600	800		• $I_{OUT} = 3\text{A}$
Ground Current (note 5)		30	60	mA	• $I_{OUT} = 1.5\text{A}$
		40			$I_{OUT} = 3\text{A}$
Ground Pin Current at Dropout		0.9		mA	$V_{IN} = 0.5\text{V}$ less than specified $V_{OUT}$ $I_{OUT} = 10\text{mA}$
Current Limit	3.0	4.5		A	$V_{OUT} = 0\text{V}$ (note 4)
Output Noise Voltage		400		$\mu\text{V}_{\text{RMS}}$	10Hz-100KHz, $I_{OUT} = 100\text{mA}$ , $C_{OUT} = 10\mu\text{F}$
		260			10Hz-100KHz, $I_{OUT} = 100\text{mA}$ , $C_{OUT} = 33\mu\text{F}$
Reference Voltage Temperature Coefficient		20		ppm/ $^\circ\text{C}$	Note 7
<b>Reference Voltage and Adjustable Pin - SPX29302</b>					
Reference Voltage	1.228	1.24	1.252	V	• $V_{REF} \leq V_{OUT} \leq (V_{IN} - 1)$ , $2.3\text{V} \leq V_{IN} \leq 16\text{V}$ $10\text{mA} \leq I_L \leq I_{FL}$ , $T_J < T_{JMAX}$
	1.215		1.265		
	1.203		1.277		
Adjust Pin Bias Current		40	80	nA	•
			120		

# SPX29300/01/02

## 3A Low Dropout Voltage Regulator

Parameter	Min.	Typ.	Max.	Units	Conditions
Adjust Pin Bias Current Temperature Coefficient		0.1		nA/°C	
<b>Power Good Flag Output – SPX29301</b>					
Output Leakage Current		0.01	1 2	μA	• V <sub>OH</sub> =16V
Output Low Voltage		220	300 400	mV	• Device set for 5V, V <sub>IN</sub> =4.5V, I <sub>OL</sub> =250μA
Upper Threshold Voltage	40 25	60		mV	• Device set for 5V, Note 8
Lower Threshold Voltage		75	95 140	mV	• Device set for 5V, Note 8
Hysteresis		15		mV	• Device set for 5V, Note 8
<b>Enable Input – SPX29301/02</b>					
Input Logic Voltage Low (OFF)			0.8	V	• V <sub>IN</sub> <10V
Input Logic Voltage High (ON)	2.4				
Enable Input Pin		100	600	μA	• V <sub>EN</sub> =16V
			750		
			1		• V <sub>EN</sub> =0.8V
			2		
Regulator Output Current in Shutdown		10	500	μA	• Note 9

Note 2: Full load current (I<sub>FL</sub>) is defined as 3.0A.

Note 3: Dropout voltage is defined (V<sub>IN</sub>-V<sub>OUT</sub>) when the output voltage drops to 99% of its nominal value.

Note 4: V<sub>IN</sub>=V<sub>OUT</sub>(nom)+1V. Use pulse-testing procedures to minimize temperature rise.

Note 5: Ground pin current is the regulator quiescent current. The total current drawn from the source is the sum of the load current to the ground current.

Note 6: Output voltage temperature coefficient is defined as the worst case voltage change divided by the total temperature range

Note 7: Thermal regulation is defined as the change in output voltage at time T after a change in power dissipation is applied, excluding load/line regulation effects. Specifications for a 200mA load pulse as V<sub>IN</sub>=20V (a 4W pulse) for t=10ms.

Note 8: Comparator threshold is expressed in terms of a voltage differential at the Adjust terminal below the nominal reference voltage measured 6V input. To express these thresholds in terms of output voltage change, multiply the error amplifier gain = V<sub>OUT</sub>/V<sub>REF</sub> = (R1 + R2)/R2. For example, at a programmable output voltage of 5V, the Error output is guaranteed to go low when the output drops by 95mVx 5V/ 1.240V = 383mV. Threshold remain constant as a percent of

V<sub>OUT</sub> as V<sub>OUT</sub> is varied, with the dropout warning occurring at typically 5% below nominal, 7.7% guaranteed.

Note 9: V<sub>EN</sub> ≤ 0.8V and V<sub>IN</sub> ≤ 16V, V<sub>OUT</sub> = 0.

# SPX29300/01/02 3A Low Dropout Voltage Regulator

## BLOCK DIAGRAM

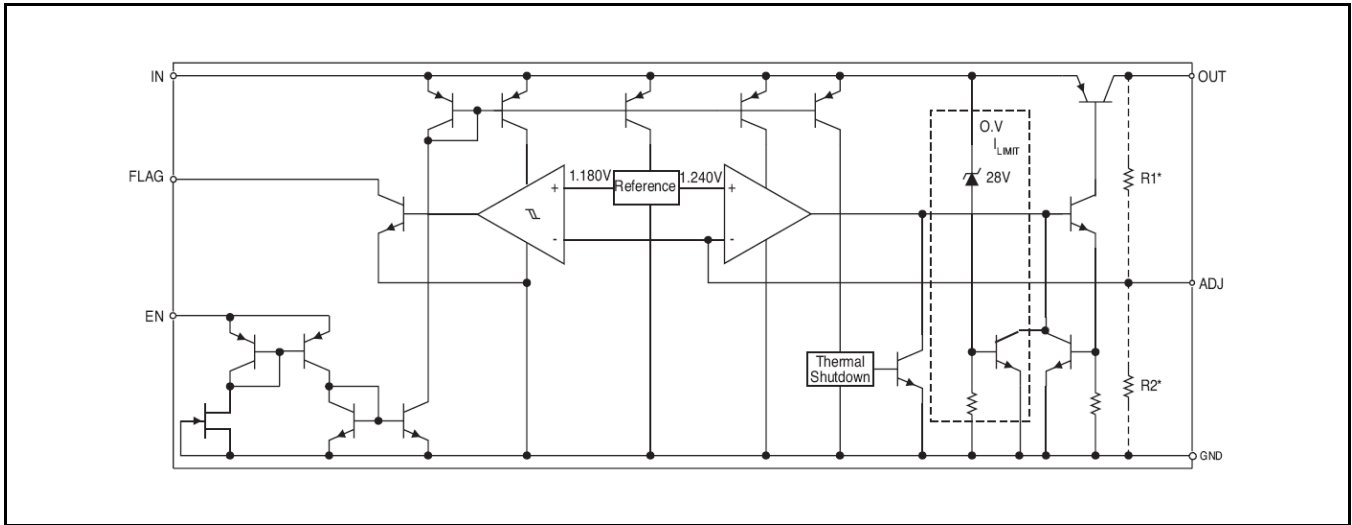

Fig. 2: SPX29300/01/02 Block Diagram

## PIN ASSIGNMENT

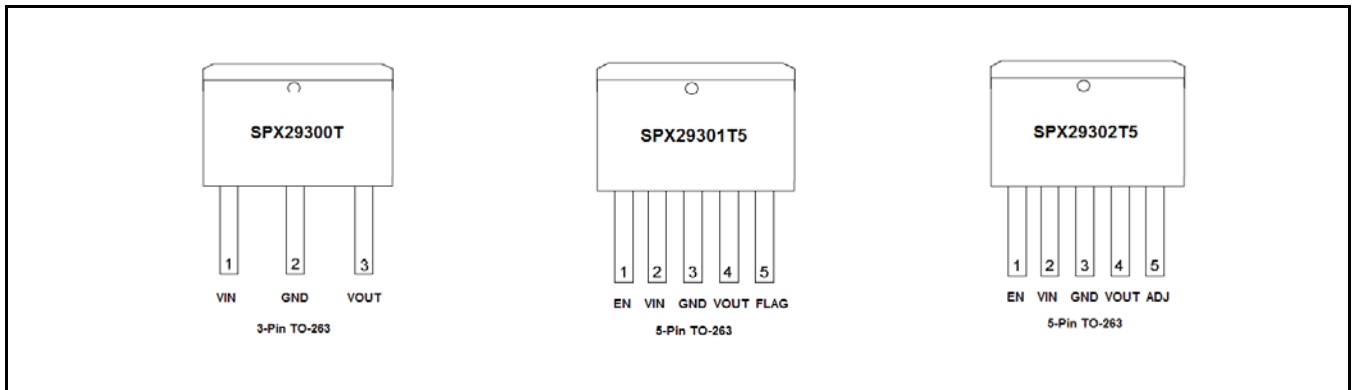

Fig. 3: SPX29300/01/02 Pin Assignment

# SPX29300/01/02

## 3A Low Dropout Voltage Regulator

### ORDERING INFORMATION

Part Number	Operating Temperature Range	Lead-Free	Package	Packing Method
SPX29300T-L-1-8/TR	$-40^{\circ}\text{C} \leq T_j \leq +125^{\circ}\text{C}$	Yes	3-pin TO263	500/Tape & Reel
SPX29300T-L-2-5/TR	$-40^{\circ}\text{C} \leq T_j \leq +125^{\circ}\text{C}$	Yes	3-pin TO263	500/Tape & Reel
SPX29300T-L-3-3	$-40^{\circ}\text{C} \leq T_j \leq +125^{\circ}\text{C}$	Yes	3-pin TO263	Bulk
SPX29300T-L-3-3/TR	$-40^{\circ}\text{C} \leq T_j \leq +125^{\circ}\text{C}$	Yes	3-pin TO263	500/Tape & Reel
SPX29300T-L-5-0/TR	$-40^{\circ}\text{C} \leq T_j \leq +125^{\circ}\text{C}$	Yes	3-pin TO263	500/Tape & Reel
SPX29301T5-L-3-3/TR	$-40^{\circ}\text{C} \leq T_j \leq +125^{\circ}\text{C}$	Yes	5-pin TO263	500/Tape & Reel
SPX29301T5-L-5-0/TR	$-40^{\circ}\text{C} \leq T_j \leq +125^{\circ}\text{C}$	Yes	5-pin TO263	500/Tape & Reel
SPX29302T5-L	$-40^{\circ}\text{C} \leq T_j \leq +125^{\circ}\text{C}$	Yes	5-pin TO263	Bulk
SPX29302T5-L/TR	$-40^{\circ}\text{C} \leq T_j \leq +125^{\circ}\text{C}$	Yes	5-pin TO263	500/Tape & Reel

"YY" = Year – "WW" = Work Week – "L" = Lead Free Designator – "X" = Lot Number

Notes:

# SPX29300/01/02

## 3A Low Dropout Voltage Regulator

### TYPICAL PERFORMANCE CHARACTERISTICS

All data taken at  $V_{IN} = V_{OUT} + 1V$ ,  $T_J = T_A = 25^\circ C$ , unless otherwise specified.

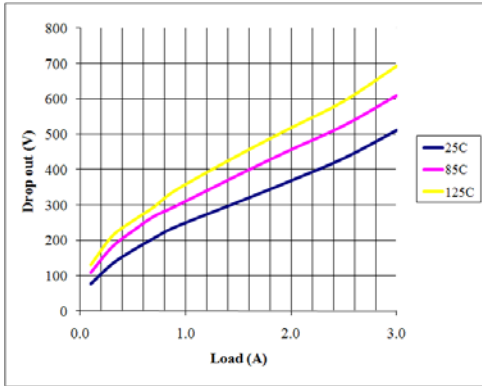

Fig. 4: Dropout Voltage vs Load Current

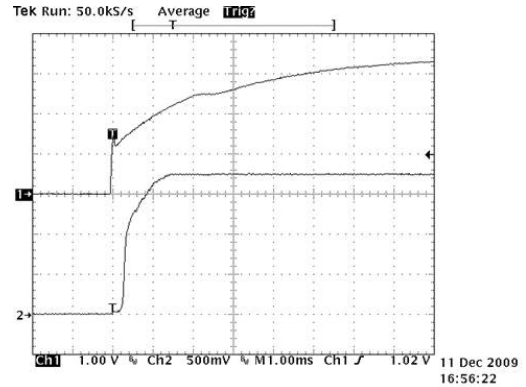

Fig. 5: Startup

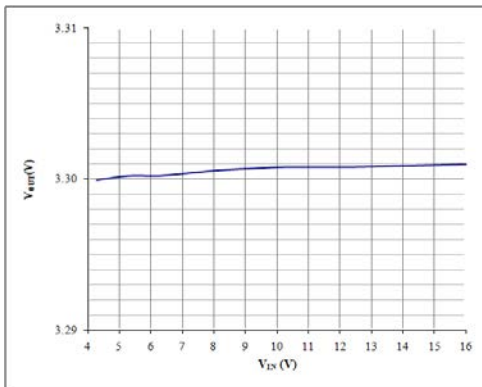

Fig. 6: Line Regulation  
 $I_{OUT} = 10mA$ ,  $V_{OUT} = 3.3V$

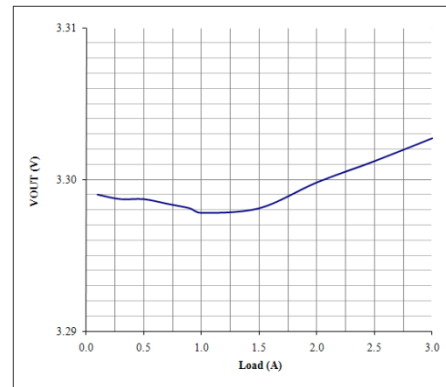

Fig. 7: Load Regulation  
 $V_{OUT} = 3.3V$

# SPX29300/01/02

## 3A Low Dropout Voltage Regulator

### THEORY OF OPERATION

The SPX29300/01/02 incorporates protection against over-current faults, reversed load insertion, over temperature operation, and positive and negative transient voltage.

### THERMAL CONSIDERATIONS

Although the SPX29300/01/02 offers limiting circuitry for overload conditions, it is still necessary to insure that the maximum junction temperature is not exceeded in the application. Heat will flow through the lowest resistance path, the junction-to-case path. In order to insure the best thermal flow of the component, proper mounting is required.

### TO-263 DESIGN EXAMPLE:

Assume that  $V_{IN} = 5V$ ,  $V_{OUT} = 3.3V$ ,  $I_{OUT} = 1.0A$ ,  $T_A = 50^\circ C$  and  $\theta_{JA} = 31.4^\circ C/W$ , where:

$T_A$  = ambient temperature,

$\theta_{JA}$  = junction to ambient thermal resistance

The power calculated under these conditions is:

$$P_D = (V_{IN} - V_{OUT}) \times I_{OUT} = 1.7W$$

And the junction temperature is calculated as

$$T_J = T_A + P_D \times \theta_{JA}$$

or

$$T_J = 50 + 1.7 \times 31.4 = 103.4^\circ C$$

Reliable operation is insured.

### CAPACITOR REQUIREMENTS

The output capacitor is needed to insure stability and minimize the output noise. The value of the capacitor varies with the load. However, a minimum value of 10 $\mu$ F aluminum capacitor will guarantee stability over all load

conditions.

A tantalum capacitor is recommended if a faster load transient response is needed. If the power source has high AC impedance, a 0.1 $\mu$ F ceramic capacitor between input & ground is recommended.

### MINIMUM LOAD CURRENT

To ensure a proper behavior of the regulator under light load, a minimum load of 5mA for SPX29300/01/02 is required.

### ADJUSTABLE REGULATOR DESIGN

The SPX29300/01/02 is an adjustable regulator that can be programmed to any value between 1.25V and 16V using 2 external resistors, R1 and R2. The relationship between the resistors and the output voltage is:

$$R_1 = R_2 \times \left( \frac{V_{OUT}}{1.240} - 1 \right)$$

### ERROR FLAG

The SPX29301 features an error flag that indicates either an over current or under current voltage condition. The flag output goes low, sinking 10mA when either conditions occurs.

### ENABLE INPUT

The SPX29301/02 has an Enable function that switches the regulator on and off. Their thresholds are TTL compatible. When the regulator is active, approximately 20 $\mu$ A flows through the Enable pin.

### TYPICAL APPLICATION CIRCUITS

Figure 1 represents the typical implementation for an adjustable output regulator. The values of R1 and R2 set the output voltage value as follows:

$$V_{OUT} = V_{REF} \times \left( 1 + \frac{R_1}{R_2} \right)$$

A minimum value of 10kohms is recommended for R2 with a range between 10k $\Omega$  and 47k $\Omega$ .

# SPX29300/01/02

## 3A Low Dropout Voltage Regulator

### PACKAGE SPECIFICATION

### 3-PIN AND 5-PIN TO-263

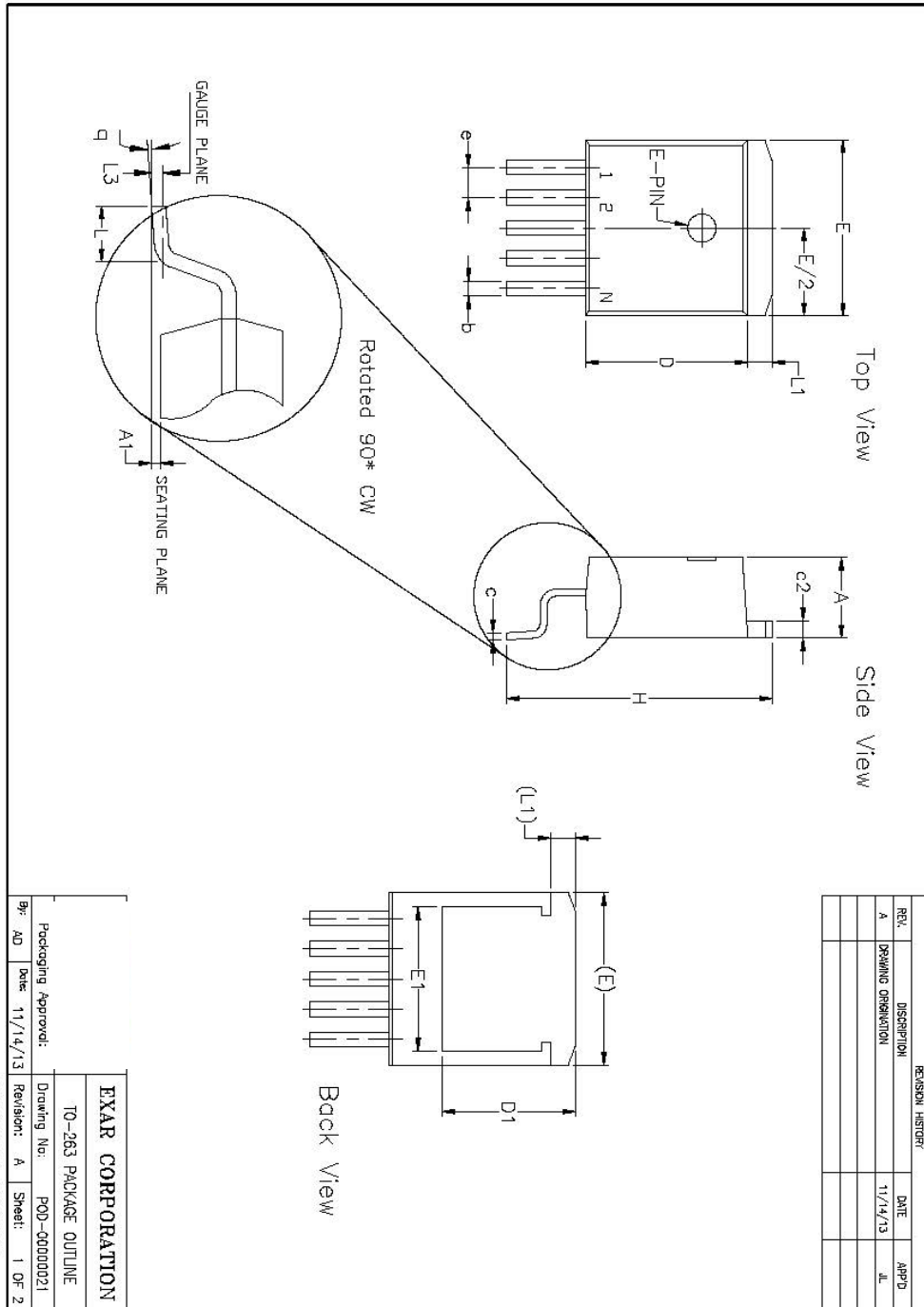



# SPX29300/01/02

## 3A Low Dropout Voltage Regulator

### PACKAGE SPECIFICATION CONTINUED

REVISION HISTORY			
REV.	DISCRIPTION	DATE	APP'D
A	DRAWING ORIGINATION	11/14/13	JL

3 Pin TO-263 JEDEC TO-263 Variation AA						
SYMBOLS	DIMENSIONS IN INCH (Control Unit)			DIMENSIONS IN MM (Reference Unit)		
	MIN	NOM	MAX	MIN	NOM	MAX
A	0.160	—	0.190	4.06	—	4.83
A1	0.000	—	0.010	0.00	—	0.25
b	0.020	—	0.039	0.51	—	0.99
b2	0.045	—	0.070	1.14	—	1.78
c	0.015	—	0.029	0.38	—	0.74
c2	0.045	—	0.065	1.14	—	1.65
D	0.330	—	0.380	8.38	—	9.65
D1	0.270	—	—	6.86	—	—
E	0.380	—	0.420	9.65	—	10.67
E1	0.245	—	—	6.22	—	—
e	0.100 BSC		2.54 BSC			
H	0.575	—	0.625	14.61	—	15.88
L	0.070	—	0.110	1.78	—	2.79
L1	—	—	0.066	—	—	1.68
L3	0.010 BSC		0.25 BSC			
Q	0*	—	8*	0*	—	8*
N	3		3			

5 Pin TO-263 JEDEC TO-263 Variation BA						
SYMBOLS	DIMENSIONS IN INCH (Control Unit)			DIMENSIONS IN MM (Reference Unit)		
	MIN	NOM	MAX	MIN	NOM	MAX
A	0.160	—	0.190	4.06	—	4.83
A1	0.000	—	0.010	0.00	—	0.25
b	0.020	—	0.039	0.51	—	0.99
c	0.015	—	0.029	0.38	—	0.74
c2	0.045	—	0.065	1.14	—	1.65
D	0.330	—	0.380	8.38	—	9.65
D1	0.270	—	—	6.86	—	—
E	0.380	—	0.420	9.65	—	10.67
E1	0.245	—	—	6.22	—	—
e	0.067 BSC		1.70 BSC			
H	0.575	—	0.625	14.61	—	15.88
L	0.070	—	0.110	1.78	—	2.79
L1	—	—	0.066	—	—	1.68
L3	0.010 BSC		0.25 BSC			
Q	0*	—	8*	0*	—	8*
N	5		5			

Packaging Approval:		EXAR CORPORATION	
		TO-263 PACKAGE OUTLINE	
By: AD	Date: 11/14/13	Drawing No: POD-0000021	Revision: A
		Sheet: 2 OF 2	

**SPX29300/01/02**  
**3A Low Dropout Voltage Regulator**

---

**REVISION HISTORY**

<b>Revision</b>	<b>Date</b>	<b>Description</b>
1.0.0	12/17/2009	Initial Release of Datasheet
2.0.0	03/31/2010	Reformat of datasheet Inserted ESD data Modified Dropout Voltage and Ground Current values in electrical characteristics table Corrected typographical error in result of calculus in note 8 Removed "Gound Current vs Load Current", "Enable Threshold vs Temperature" and "Power Supply Rejection Ratio curves" Updated "Dropout Voltage vs Load Current", "Line Regulation" and "Load Regulation" curves Added "start Up" curve
2.1.0	10/19/2010	Corrected Adjustable Regulator Design paragraph equation
2.2.0	12/21/2016	Updated package specification and ordering information

**FOR FURTHER ASSISTANCE**

Technical Support:

Email:

Exar Technical Documentation: