



SGM2040

1 μ A Ultra Low Current Consumption and Low Dropout CMOS Voltage Regulators

GENERAL DESCRIPTION

The SGM2040 series are positive voltage regulators with ultra low current consumption, low dropout voltage, high-accuracy output voltage and 250mA output current, developed in CMOS technology.

Input and output capacitors as small as 0.1 μ F can be used. The SGM2040 series operate with an ultra low current consumption, only 1 μ A typical current is consumed to prolong the battery used time.

The built-in low on-resistance transistor realizes low dropout voltage and a large output current. A built-in over-current protection circuit prevents the load current from exceeding the current capacity of the output transistor. Reverse current is less than 0.2 μ A (TYP) when $V_{OUT} > V_{IN}$.

Compared with voltage regulators using a conventional CMOS technology, more types of capacitors, including small input and output capacitors, can be used with the SGM2040 series. The SGM2040 series feature ultra low current consumption and come in small packages, making them most suitable for portable equipment.

The SGM2040 is available in Green UTDFN-1 \times 1-4AL and SOT-23-5 packages. It operates over an ambient temperature range of -40 $^{\circ}$ C to +85 $^{\circ}$ C.

FEATURES

- **Output Voltage: 1.2V to 5.2V with 0.05V per Step**
- **Input Voltage: 1.7V to 7.5V**
- **High Output Voltage Accuracy**
- **Low Dropout Voltage**
- **Ultra Low Current Consumption: 1.0 μ A (TYP)**
- **250mA Nominal Output Current**
- **Input and Output Capacitors:
Ceramic Capacitors of 0.1 μ F or Higher can be Used**
- **Low Reverse Leakage Current when $V_{OUT} > V_{IN}$**
- **Built-In Over-Temperature Protection**
- **Built-In Over-Current Protection Circuit**
- **Supports 1.8V Logic for EN Pin**
- **-40 $^{\circ}$ C to +85 $^{\circ}$ C Operating Temperature Range**
- **Available in Green SOT-23-5 and UTDFN-1 \times 1-4AL Packages**

APPLICATIONS

Wearable Device
Smart Phone
Portable Equipment

PACKAGE/ORDERING INFORMATION

MODEL	PACKAGE DESCRIPTION	SPECIFIED TEMPERATURE RANGE	ORDERING NUMBER	PACKAGE MARKING	PACKING OPTION
SGM2040-1.2	SOT-23-5	-40°C to +85°C	SGM2040-1.2YN5G/TR	MBEXX	Tape and Reel, 3000
SGM2040-1.5	SOT-23-5	-40°C to +85°C	SGM2040-1.5YN5G/TR	MC5XX	Tape and Reel, 3000
SGM2040-1.8	SOT-23-5	-40°C to +85°C	SGM2040-1.8YN5G/TR	M65XX	Tape and Reel, 3000
SGM2040-2.5	SOT-23-5	-40°C to +85°C	SGM2040-2.5YN5G/TR	MBDXX	Tape and Reel, 3000
SGM2040-2.8	SOT-23-5	-40°C to +85°C	SGM2040-2.8YN5G/TR	M66XX	Tape and Reel, 3000
SGM2040-3.0	SOT-23-5	-40°C to +85°C	SGM2040-3.0YN5G/TR	GPAXX	Tape and Reel, 3000
SGM2040-3.3	SOT-23-5	-40°C to +85°C	SGM2040-3.3YN5G/TR	M67XX	Tape and Reel, 3000
SGM2040-3.6	SOT-23-5	-40°C to +85°C	SGM2040-3.6YN5G/TR	MBFXX	Tape and Reel, 3000
SGM2040-4.0	SOT-23-5	-40°C to +85°C	SGM2040-4.0YN5G/TR	MC0XX	Tape and Reel, 3000
SGM2040-4.2	SOT-23-5	-40°C to +85°C	SGM2040-4.2YN5G/TR	MC1XX	Tape and Reel, 3000
SGM2040-5.0	SOT-23-5	-40°C to +85°C	SGM2040-5.0YN5G/TR	M2FXX	Tape and Reel, 3000
SGM2040-1.2	UTDFN-1×1-4AL	-40°C to +85°C	SGM2040-1.2YUDH4G/TR	C6X	Tape and Reel, 3000
SGM2040-1.5	UTDFN-1×1-4AL	-40°C to +85°C	SGM2040-1.5YUDH4G/TR	C7X	Tape and Reel, 3000
SGM2040-1.8	UTDFN-1×1-4AL	-40°C to +85°C	SGM2040-1.8YUDH4G/TR	69X	Tape and Reel, 10000
SGM2040-2.5	UTDFN-1×1-4AL	-40°C to +85°C	SGM2040-2.5YUDH4G/TR	C8X	Tape and Reel, 10000
SGM2040-2.8	UTDFN-1×1-4AL	-40°C to +85°C	SGM2040-2.8YUDH4G/TR	6AX	Tape and Reel, 10000
SGM2040-3.0	UTDFN-1×1-4AL	-40°C to +85°C	SGM2040-3.0YUDH4G/TR	C9X	Tape and Reel, 10000
SGM2040-3.3	UTDFN-1×1-4AL	-40°C to +85°C	SGM2040-3.3YUDH4G/TR	6BX	Tape and Reel, 10000
SGM2040-3.6	UTDFN-1×1-4AL	-40°C to +85°C	SGM2040-3.6YUDH4G/TR	CAX	Tape and Reel, 10000
SGM2040-4.0	UTDFN-1×1-4AL	-40°C to +85°C	SGM2040-4.0YUDH4G/TR	CBX	Tape and Reel, 10000
SGM2040-4.2	UTDFN-1×1-4AL	-40°C to +85°C	SGM2040-4.2YUDH4G/TR	CCX	Tape and Reel, 10000
SGM2040-5.0	UTDFN-1×1-4AL	-40°C to +85°C	SGM2040-5.0YUDH4G/TR	CDX	Tape and Reel, 10000

NOTE: X = Date Code. XX = Date Code.

MARKING INFORMATION

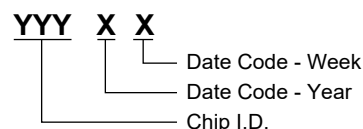

MARKING INFORMATION

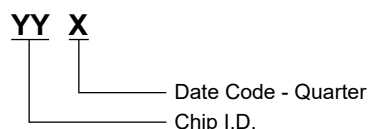

Green (RoHS & HSF): SG Micro Corp defines "Green" to mean Pb-Free (RoHS compatible) and free of halogen substances. If you have additional comments or questions, please contact your SGMICRO representative directly.

ABSOLUTE MAXIMUM RATINGS

IN to GND8V
 OUT to GND6V
 Package Thermal Resistance
 SOT-23-5, θ_{JA} 207°C/W
 UTDFN-1×1-4AL, θ_{JA} 238°C/W
 Junction Temperature+150°C
 Storage Temperature Range-65°C to +150°C
 Lead Temperature (Soldering, 10s)+260°C

RECOMMENDED OPERATING CONDITIONS

Input Voltage Range1.7V to 7.5V
 Operating Temperature Range-40°C to +85°C

OVERSTRESS CAUTION

Stresses beyond those listed may cause permanent damage to the device. Functional operation of the device at these or any other conditions beyond those indicated in the operational section of the specification is not implied. Exposure to absolute maximum rating conditions for extended periods may affect reliability.

ESD SENSITIVITY CAUTION

This integrated circuit can be damaged by ESD if you don't pay attention to ESD protection. SGMICRO recommends that all integrated circuits be handled with appropriate precautions. Failure to observe proper handling and installation procedures can cause damage. ESD damage can range from subtle performance degradation to complete device failure. Precision integrated circuits may be more susceptible to damage because very small parametric changes could cause the device not to meet its published specifications.

DISCLAIMER

SG Micro Corp reserves the right to make any change in circuit design, specification or other related things if necessary without notice at any time.

PIN CONFIGURATIONS

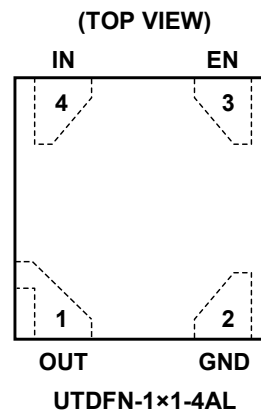
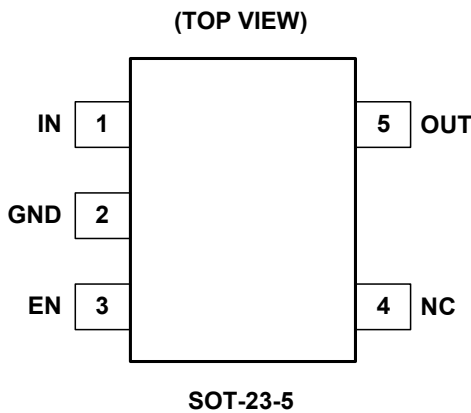

PIN DESCRIPTION

PIN		NAME	FUNCTION
SOT-23-5	UTDFN-1×1-4AL		
1	4	IN	Input Voltage Pin.
2	2	GND	GND Pin.
3	3	EN	Enable Pin. This pin has an internal pull-down resistor. A logic low reduces the supply current to less than 1µA. Connect to logic "High" for normal operation.
4	–	NC	Not Connected.
5	1	OUT	Output Voltage Pin.

ELECTRICAL CHARACTERISTICS

(V_{IN} = V_{OUT(NOMINAL)} + 1V, Full = -40°C to +85°C, typical values are at T_A = +25°C, unless otherwise noted.)

PARAMETER	SYMBOL	CONDITIONS	TEMP	MIN	TYP	MAX	UNITS
Input Voltage	V _{IN}		+25°C	1.7		7.5	V
Output Voltage Accuracy		I _{OUT} = 1mA	+25°C	-3		+3	%
Maximum Output Current ⁽¹⁾			+25°C		250		mA
Current Limit	I _{LIM}		+25°C		440		mA
Supply Pin Current	I _Q	No load	+25°C		1.0		μA
Dropout Voltage ⁽²⁾	V _{DROP}	I _{OUT} = 100mA	V _{OUT} = 2.8V	+25°C	0.11		V
			V _{OUT} = 3.3V	+25°C	0.09		
			V _{OUT} = 5.0V	+25°C	0.06		
Line Regulation	$\frac{\Delta V_{OUT}}{\Delta V_{IN} \times V_{OUT}}$	V _{IN} = V _{OUT} + 1V to 7.5V	I _{OUT} = 100μA	+25°C	0.001		%V
			I _{OUT} = 30mA	+25°C	0.004		
Load Regulation	ΔV_{OUT}	I _{OUT} = 100μA to 250mA	+25°C		0.3		mV
Short Current Limit	I _{SHORT}	V _{OUT} = 0V	+25°C		86		mA
Reverse Leakage Current	I _{RL}	V _{IN} = 1.7V, V _{OUT} = 5.5V	+25°C		0.2		μA
Power Supply Rejection Ratio	PSRR	I _{OUT} = 30mA, C _{OUT} = 0.1μF, ΔV _{RIPPLE} = 0.2V _{P-P}	f = 217Hz	+25°C	38		dB
			f = 1kHz	+25°C	27		
Output Voltage Temperature Coefficient ⁽³⁾	$\frac{\Delta V_{OUT}}{\Delta T_A \times V_{OUT}}$	I _{OUT} = 1mA	Full		18		ppm/°C
SHUTDOWN							
EN Input Threshold	V _{IH}	V _{IN} = 1.7V to 5.5V	Full	1.7			V
	V _{IL}		Full			0.2	V
EN Input Bias Current	I _{BH}	V _{EN} = 5.5V	Full		36		nA
	I _{BL}	V _{EN} = 0V	Full		0.2		
Shutdown Supply Current	I _{SHDN}	V _{EN} = 0V	Full		0.8		μA
Output Discharge Resistance	R _{DISCH}	V _{EN} = 0V, V _{OUT} = 0.5V	+25°C		66		Ω

NOTES:

- Maximum output current is affected by the PCB layout, size of metal trace, the thermal conduction path between metal layers, ambient temperature and the other environment factors of system. Attention should be paid to the dropout voltage when V_{IN} < V_{OUT} + V_{DROP}.
- Dropout voltage is characterized when V_{OUT} falls 5% below V_{OUT(NOMINAL)}.
- Output voltage temperature coefficient is defined as the worst-case voltage change divided by the total temperature range.

FUNCTIONAL BLOCK DIAGRAM

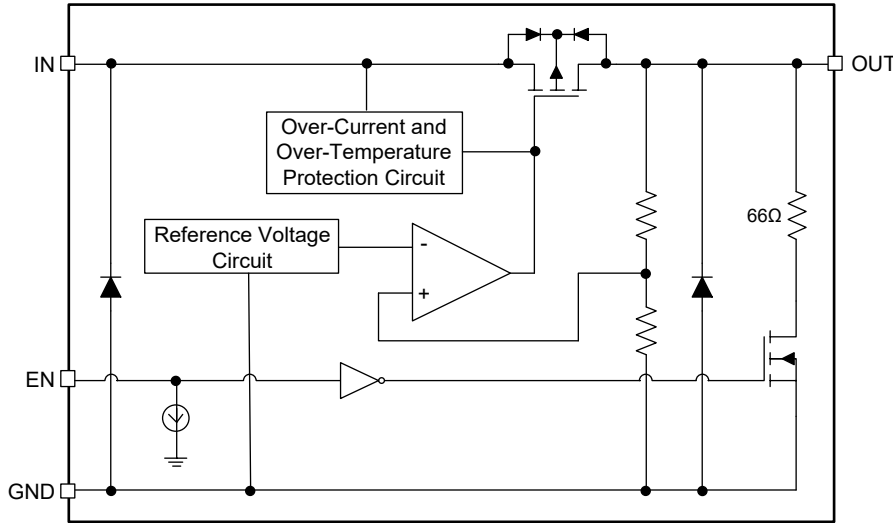

Figure 1. Block Diagram

APPLICATION INFORMATION

Standard Circuit

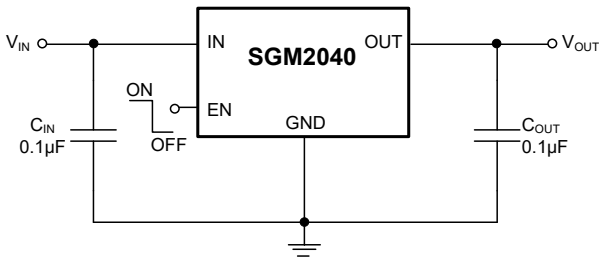

Figure 2. Standard Circuit

Condition of Application

Input Capacitor (C_{IN}): 0.1µF or higher
 Output Capacitor (C_{OUT}): 0.1µF or higher

Caution: Generally regulator may oscillate depending on the selection of external components.

Confirm that no oscillation occurs in the application for which the above capacitors are used.

Selection of Input and Output Capacitors

The SGM2040 series require an output capacitor (C_{OUT}) between the OUT pin and GND pin for phase compensation.

Operation is stable with a ceramic capacitor of 0.1µF or higher in the entire temperature range. When using an OS capacitor, a tantalum capacitor, or an aluminum

electrolytic capacitor, the capacitance must be 0.1µF or higher.

The value of the output overshoot or undershoot transient response varies depending on the value of the output capacitor.

The required capacitance of the input capacitor (C_{IN}) differs depending on the application.

The recommended value for an application is $C_{IN} \geq 0.1\mu F$, $C_{OUT} \geq 0.1\mu F$; however, when selecting these capacitors, perform sufficient evaluation, including evaluation of temperature characteristics, on the actual device.

The SGM2040 series enable use of a low equivalent series resistance capacitor, such as a ceramic capacitor, for the output-side capacitor (C_{OUT}).

Over-Current Protection Circuit

The SGM2040 series include an over-current protection circuit having the characteristics shown in the table of electrical characteristics, in order to protect the output transistor against an excessive output current and short circuiting between the OUT and GND pins. The current when the output pin is short-circuited (I_{SHORT}) is internally set at approximately 86mA (TYP), and the normal value is restored for the output voltage, if the short circuit condition is released.

PACKAGE OUTLINE DIMENSIONS

SOT-23-5

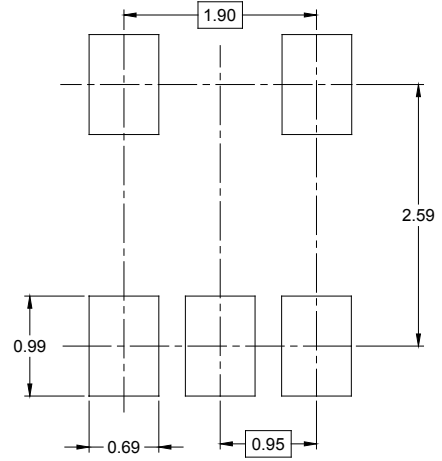
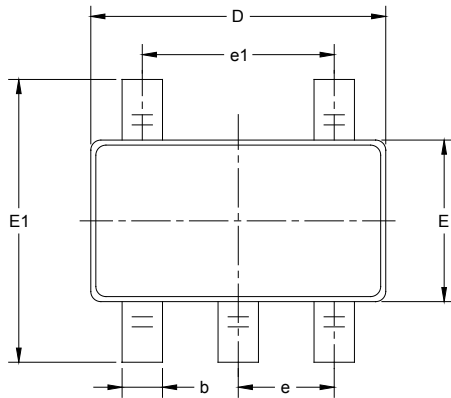

RECOMMENDED LAND PATTERN (Unit: mm)

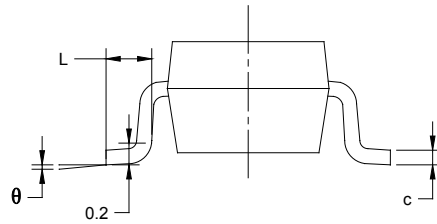
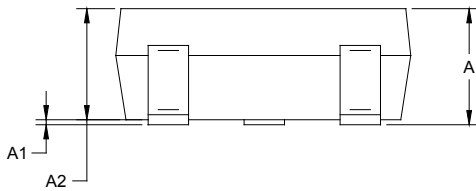

Symbol	Dimensions In Millimeters		Dimensions In Inches	
	MIN	MAX	MIN	MAX
A	1.050	1.250	0.041	0.049
A1	0.000	0.100	0.000	0.004
A2	1.050	1.150	0.041	0.045
b	0.300	0.500	0.012	0.020
c	0.100	0.200	0.004	0.008
D	2.820	3.020	0.111	0.119
E	1.500	1.700	0.059	0.067
E1	2.650	2.950	0.104	0.116
e	0.950 BSC		0.037 BSC	
e1	1.900 BSC		0.075 BSC	
L	0.300	0.600	0.012	0.024
θ	0°	8°	0°	8°

PACKAGE OUTLINE DIMENSIONS

UTDFN-1x1-4AL

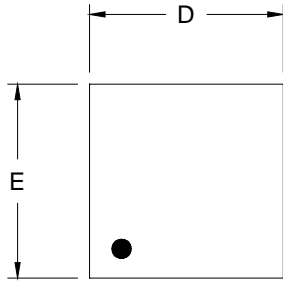

TOP VIEW

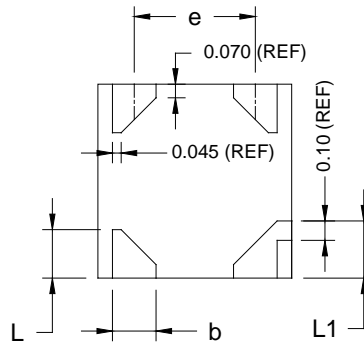

BOTTOM VIEW

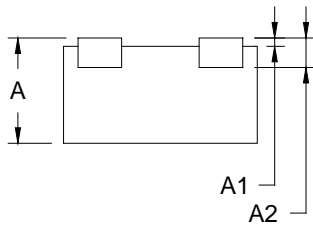

SIDE VIEW

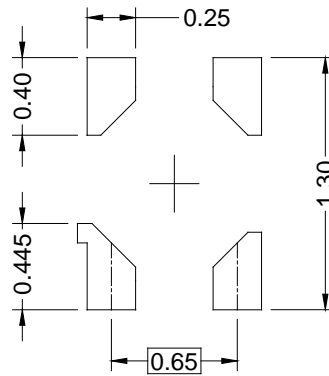

RECOMMENDED LAND PATTERN (Unit: mm)

Symbol	Dimensions In Millimeters		
	MIN	MOD	MAX
A	0.500	0.550	0.600
A1	0.000		0.050
A2	0.152 REF		
e	0.625 BSC		
D	0.950	1.000	1.050
E	0.950	1.000	1.050
b	0.175	0.225	0.275
L	0.200	0.250	0.300
L1	0.245	0.295	0.345

TAPE AND REEL INFORMATION

REEL DIMENSIONS

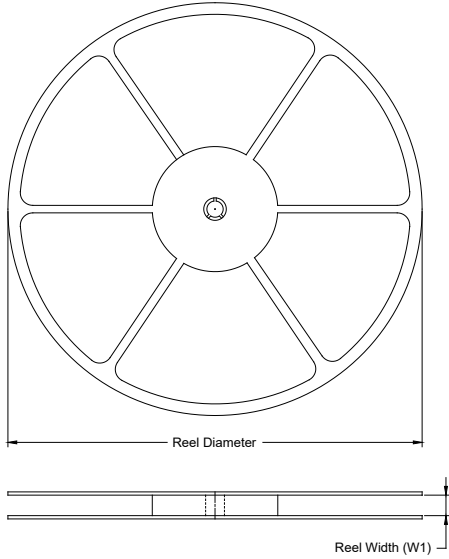

TAPE DIMENSIONS

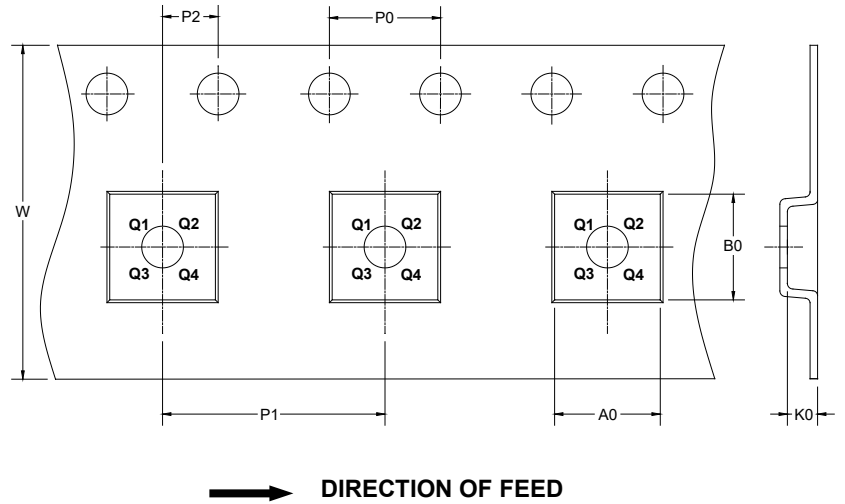

NOTE: The picture is only for reference. Please make the object as the standard.

KEY PARAMETER LIST OF TAPE AND REEL

Package Type	Reel Diameter	Reel Width W1 (mm)	A0 (mm)	B0 (mm)	K0 (mm)	P0 (mm)	P1 (mm)	P2 (mm)	W (mm)	Pin1 Quadrant
SOT-23-5	7"	9.5	3.20	3.20	1.40	4.0	4.0	2.0	8.0	Q3
UTDFN-1×1-4AL	7"	9.0	1.16	1.16	0.63	4.0	2.0	2.0	8.0	Q1

DD0001

PACKAGE INFORMATION

CARTON BOX DIMENSIONS



NOTE: The picture is only for reference. Please make the object as the standard.

KEY PARAMETER LIST OF CARTON BOX

Reel Type	Length (mm)	Width (mm)	Height (mm)	Pizza/Carton
7" (Option)	368	227	224	8
7"	442	410	224	18

DD0002