

Ultra-Small, Low on Resistance Load Switch with Controlled Turn-on

Check for Samples: [TPS22910](#)

FEATURES

- Integrated Single Load Switch
- Ultra Small CSP-4 Package 0.9mm × 0.9mm, 0.5mm Pitch
- Input Voltage Range: 1.4-V to 5.5-V
- Low ON-Resistance
 - $r_{ON} = 60\text{-m}\Omega$ at $V_{IN} = 5\text{-V}$
 - $r_{ON} = 61\text{-m}\Omega$ at $V_{IN} = 3.3\text{-V}$
 - $r_{ON} = 74\text{-m}\Omega$ at $V_{IN} = 1.8\text{-V}$
 - $r_{ON} = 84\text{-m}\Omega$ at $V_{IN} = 1.5\text{-V}$
- 2-A Maximum Continuous Switch Current
- Low Threshold Control Input
- Controlled Slew-rate Options
- Under-Voltage Lock Out
- Reverse Current Protection

APPLICATIONS

- Portable Industrial / Medical Equipment
- Portable Media Players
- Point Of Sales Terminals
- GPS Navigation Devices
- Digital Cameras
- Portable Instrumentation
- Smartphones / Wireless Handsets

DESCRIPTION

The TPS22910 is a small, low r_{ON} load switch with controlled turn on. The device contains a P-channel MOSFET that can operate over an input voltage range of 1.4 V to 5.5 V. The switch is controlled by an on/off input (ON), which is capable of interfacing directly with low-voltage control signals. The TPS22910 is active low enable.

The slew rate of the device is internally controlled in order to avoid inrush current. The TPS22910 family has various rise time options (see [Table 1](#)).

The TPS22910 device provides circuit breaker functionality by latching off the power-switch during reverse voltage situations. An internal reverse voltage comparator disables the power-switch when the output voltage (V_{OUT}) is driven higher than the input (V_{IN}) to quickly (10 μ s typ) stop the flow of current towards the input side of the switch. Reverse current protection is always active, even when the power-switch is disabled. Additionally, under-voltage lockout (UVLO) protection turns the switch off if the input voltage is too low.

The TPS22910 is available in an ultra-small, space-saving 4-pin CSP package and is characterized for operation over the free-air temperature range of -40°C to 85°C .

TYPICAL APPLICATION

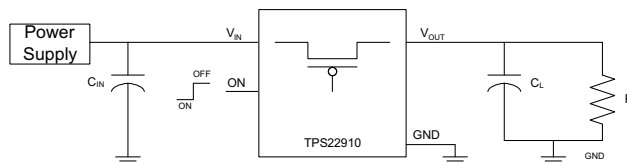

Table 1. Feature List

DEVICE	r_{ON} (typ) at 3.3 V	RISE TIME at 3.3V (typ)	QUICK OUTPUT DISCHARGE ⁽¹⁾	MAXIMUM OUTPUT CURRENT	ENABLE
TPS22910A	63 m Ω	1 μ s	No	2-A	Active Low
TPS22910B ⁽²⁾	63 m Ω	100 μ s	No	2-A	Active Low
TPS22910C ⁽²⁾	63 m Ω	1000 μ s	No	2-A	Active Low
TPS22910D ⁽²⁾	63 m Ω	4500 μ s	No	2-A	Active Low

(1) This feature discharges the output of the switch to ground through an 150- Ω resistor, preventing the output from floating.

(2) Contact local sales/distributor or factory for availability.

TPS22910

SLVSB49B – NOVEMBER 2011 – REVISED APRIL 2012



These devices have limited built-in ESD protection. The leads should be shorted together or the device placed in conductive foam during storage or handling to prevent electrostatic damage to the MOS gates.

ORDERING INFORMATION

T _A	PACKAGE ⁽¹⁾		ORDERABLE PART NUMBER	TOP-SIDE MARKING/ STATUS ⁽²⁾
-40°C to 85°C	YZV (0.5mm pitch)	Tape and Reel	TPS22910AYZVR	____ 75
-40°C to 85°C	YZV (0.5mm pitch)	Tape and Reel	TPS22910BYZVR	Contact factory for availability
-40°C to 85°C	YZV (0.5mm pitch)	Tape and Reel	TPS22910CYZVR	Contact factory for availability
-40°C to 85°C	YZV (0.5mm pitch)	Tape and Reel	TPS22910DYZVR	Contact factory for availability

- (1) Package drawings, standard packing quantities, thermal data, symbolization, and PCB design guidelines are available at www.ti.com/sc/package.
 (2) Contact factory for details and availability for PREVIEW devices, minimum order quantities may apply.

DEVICE INFORMATION

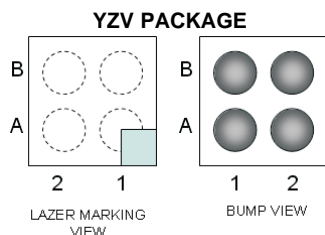

TERMINAL ASSIGNMENTS

B	ON	GND
A	V _{IN}	V _{OUT}
	2	1

PIN FUNCTIONS

TPS22910	PIN NAME	DESCRIPTION
YZV		
B1	GND	Ground
B2	ON	Switch control input, active low. Do not leave floating
A1	V _{OUT}	Switch output
A2	V _{IN}	Switch input, bypass this input with a ceramic capacitor to ground

BLOCK DIAGRAM

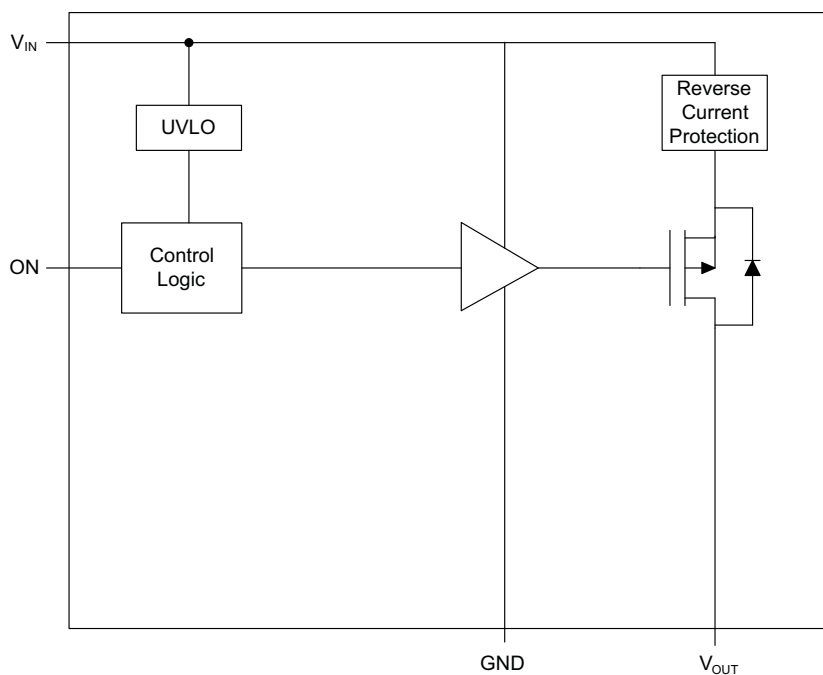

Table 2. FUNCTION TABLE

ON	VIN to VOUT
L	ON
H	OFF

ABSOLUTE MAXIMUM RATINGS

		VALUE	UNIT
V _{IN}	Input voltage range	-0.3 to 6	V
V _{OUT}	Output voltage range	-0.3 to 6	V
V _{ON}	Input voltage range	-0.3 to 6	V
I _{MAX}	Maximum continuous switch current	2	A
I _{PLS}	Maximum pulsed switch current, pulse <300 μS, 2% duty cycle	2.5	A
T _A	Operating free-air temperature range	-40 to 85	°C
T _J	Maximum junction temperature	125	°C
T _{STG}	Storage temperature range	-65 to 150	°C
T _{LEAD}	Maximum lead temperature (10-s soldering time)	300	°C
ESD	Electrostatic discharge protection	Human-Body Model (HBM) (VIN, VOUT, GND pins)	2000
		Charged-Device Model (CDM) (VIN, VOUT, ON, GND pins)	1000

TPS22910

SLVSB49B – NOVEMBER 2011 – REVISED APRIL 2012

THERMAL INFORMATION

THERMAL METRIC ⁽¹⁾		TPS22910		UNITS
		CSP		
		(4) PINS		
θ_{JA}	Junction-to-ambient thermal resistance	189.1		°C/W
θ_{JCTop}	Junction-to-case (top) thermal resistance	1.9		
θ_{JB}	Junction-to-board thermal resistance	36.8		
ψ_{JT}	Junction-to-top characterization parameter	11.3		
ψ_{JB}	Junction-to-board characterization parameter	36.8		
θ_{JCbott}	Junction-to-case (bottom) thermal resistance	N/A		

(1) For more information about traditional and new thermal metrics, see the *IC Package Thermal Metrics* application report, [SPRA953](#).

RECOMMENDED OPERATING CONDITIONS

			MIN	MAX	UNIT
V_{IN}	Input voltage range		1.4	5.5	V
V_{ON}	ON voltage range		0	5.5	V
V_{OUT}	Output voltage range			V_{IN}	
V_{IH}	High-level input voltage, ON	$V_{IN} = 3.61 \text{ V to } 5.5 \text{ V}$	1.1	5.5	V
		$V_{IN} = 1.4 \text{ V to } 3.6 \text{ V}$	1.1	5.5	V
V_{IL}	Low-level input voltage, ON	$V_{IN} = 3.61 \text{ V to } 5.5 \text{ V}$		0.6	V
		$V_{IN} = 1.4 \text{ V to } 3.6 \text{ V}$		0.4	V
C_{IN}	Input Capacitor		1 ⁽¹⁾		μF

(1) Refer to the application section.

ELECTRICAL CHARACTERISTICS

VIN = 1.4 V to 5.5 V, TA = –40°C to 85°C (unless otherwise noted)

PARAMETER		TEST CONDITIONS	TA	MIN	TYP	MAX	UNIT
IIN	Quiescent current	IOUT = 0, VIN = 5.25 V, VON = 0 V	Full		2	10	μA
		IOUT = 0, VIN = 4.2 V, VON = 0 V			2	7.0	
		IOUT = 0, VIN = 3.6 V, VON = 0 V			2	7.0	
		IOUT = 0, VIN = 2.5 V, VON = 0 V			0.9	5	
		IOUT = 0, VIN = 1.5 V, VON = 0 V			0.7	5	
IIN(off)	Off supply current	VOUT = Open, VIN = VON = 5.25 V	Full		1.2	10	μA
		VOUT = Open, VIN = VON = 4.2 V			0.2	7.0	
		VOUT = Open, VIN = VON = 3.6 V			0.1	7.0	
		VOUT = Open, VIN = VON = 2.5 V			0.1	5	
		VOUT = Open, VIN = VON = 1.5 V			0.1	5	
IIN(Leakage)	Leakage current	VOUT = 0 V, VIN = VON = 5.25 V	Full		1.2	10	μA
		VOUT = 0 V, VIN = VON = 4.2 V			0.2	7.0	
		VOUT = 0 V, VIN = VON = 3.6 V			0.1	7.0	
		VOUT = 0 V, VIN = VON = 2.5 V			0.1	5	
		VOUT = 0 V, VIN = VON = 1.5 V			0.1	5	
rON	On-resistance	VIN = 5.25 V, IOUT = –200 mA	25°C		60	80	mΩ
			Full			110	
		VIN = 5.0 V, IOUT = –200 mA	25°C		60	80	
			Full			110	
		VIN = 4.2 V, IOUT = –200 mA	25°C		60	80	
			Full			110	
		VIN = 3.3 V, IOUT = –200 mA	25°C		60.7	80	
			Full			110	
		VIN = 2.5 V, IOUT = –200 mA	25°C		63.4	90	
			Full			120	
		VIN = 1.8 V, IOUT = –200 mA	25°C		74.2	100	
			Full			130	
		VIN = 1.5 V, IOUT = –200 mA	25°C		83.9	120	
			Full			150	
UVLO	Under voltage lockout	VIN increasing, VON = 0 V, IOUT = –100 mA VIN decreasing, VON = 0 V, RL = 10 Ω	Full			1.2	V
				0.50			
ION	ON input leakage current	VON = 1.4 V to 5.25 V or GND	Full			1	μA
VRVP	Reverse Current Voltage Threshold				44		mV
tDELAY	Reverse Current Response Delay	VIN = 5V			10		μs

TPS22910

SLVSB49B – NOVEMBER 2011 – REVISED APRIL 2012

SWITCHING CHARACTERISTICS

PARAMETER	TEST CONDITION	TPS22910A	UNIT
		TYP	
V_{IN} = 5 V, T_A = 25°C (unless otherwise noted)			
t _{ON} Turn-ON time	R _L = 10 Ω, C _L = 0.1 μF	2	μs
t _{OFF} Turn-OFF time	R _L = 10 Ω, C _L = 0.1 μF	5.5	
t _R VOUT rise time	R _L = 10 Ω, C _L = 0.1 μF	1	
t _F VOUT fall time	R _L = 10 Ω, C _L = 0.1 μF	3	
V_{IN} = 3.3 V, T_A = 25°C (unless otherwise noted)			
t _{ON} Turn-ON time	R _L = 10 Ω, C _L = 0.1 μF	2.5	μs
t _{OFF} Turn-OFF time	R _L = 10 Ω, C _L = 0.1 μF	7	
t _R VOUT rise time	R _L = 10 Ω, C _L = 0.1 μF	1	
t _F VOUT fall time	R _L = 10 Ω, C _L = 0.1 μF	3.5	
V_{IN} = 1.5 V, T_A = 25°C (unless otherwise noted)			
t _{ON} Turn-ON time	R _L = 10 Ω, C _L = 0.1 μF	4.5	μs
t _{OFF} Turn-OFF time	R _L = 10 Ω, C _L = 0.1 μF	16.5	
t _R VOUT rise time	R _L = 10 Ω, C _L = 0.1 μF	2	
t _F VOUT fall time	R _L = 10 Ω, C _L = 0.1 μF	7	

PARAMETRIC MEASUREMENT INFORMATION

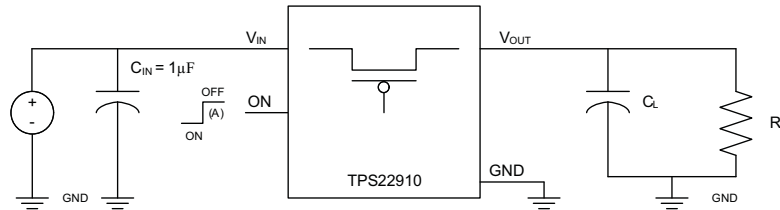

TEST CIRCUIT

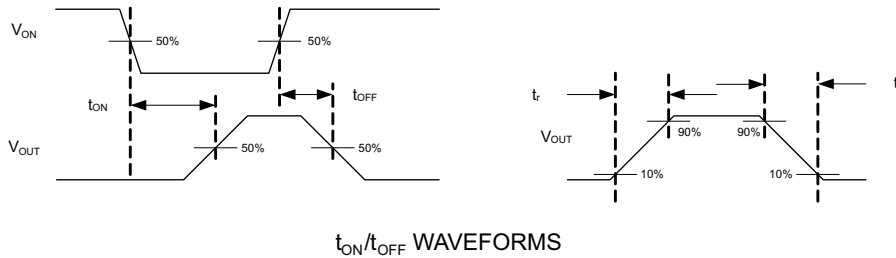

t_{ON}/t_{OFF} WAVEFORMS

(A) Rise and fall times of the control signal is 100ns.

- A. Rise and fall times of the control signal is 100 ns.

Figure 1. Test Circuit and t_{ON}/t_{OFF} Waveforms

TYPICAL CHARACTERISTICS

ON-STATE RESISTANCE
vs
INPUT VOLTAGE

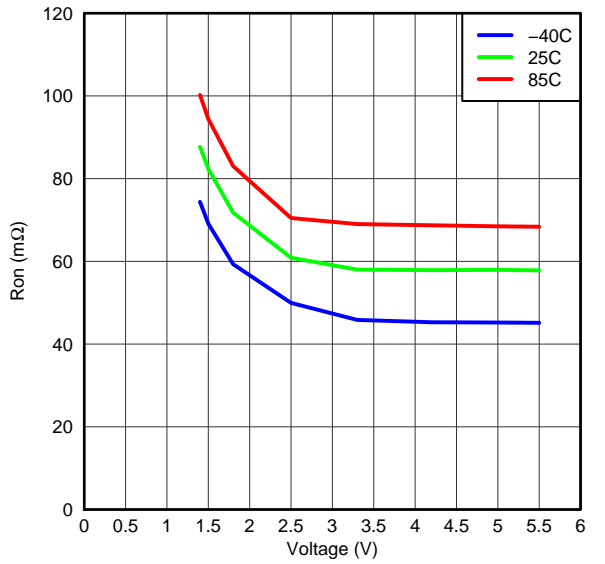

Figure 2.

ON INPUT THRESHOLD

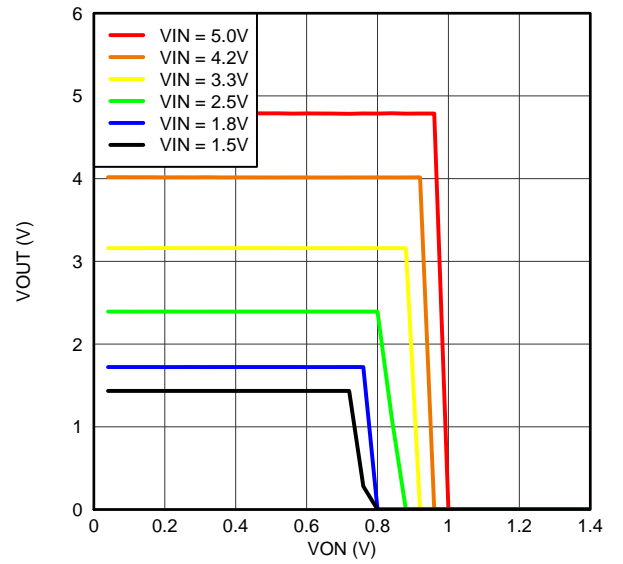

Figure 3.

INPUT CURRENT, QUIESCENT
vs
INPUT VOLTAGE

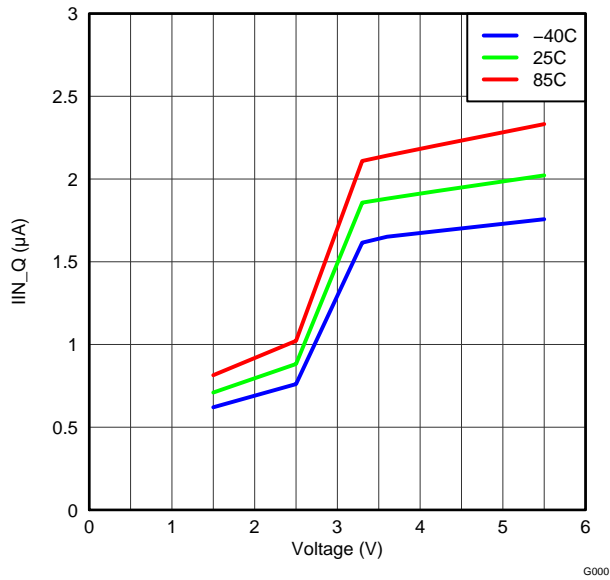

Figure 4.

INPUT CURRENT, LEAK
vs
INPUT VOLTAGE

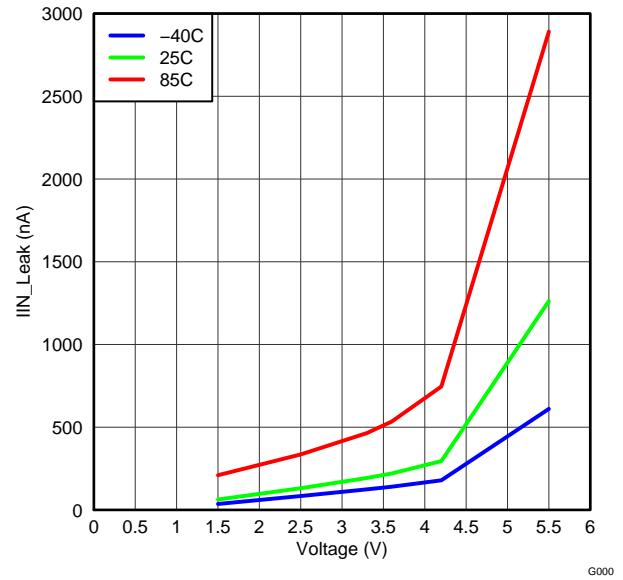

Figure 5.

TYPICAL CHARACTERISTICS (continued)

ON-STATE RESISTANCE
vs
TEMPERATURE

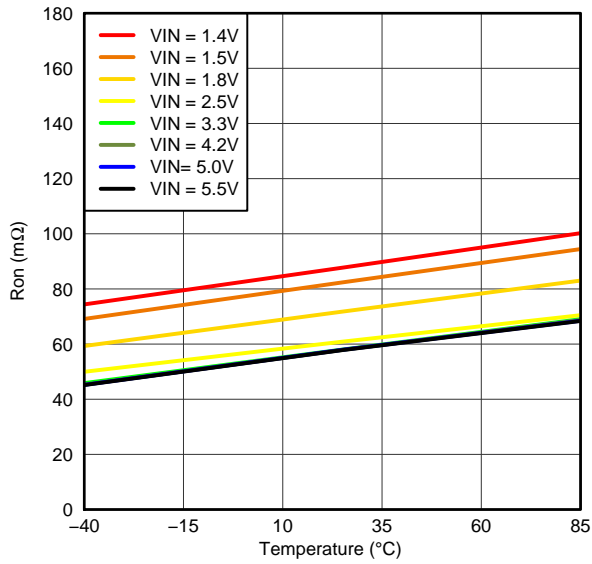

Figure 6.

INPUT CURRENT, OFF
vs
INPUT VOLTAGE

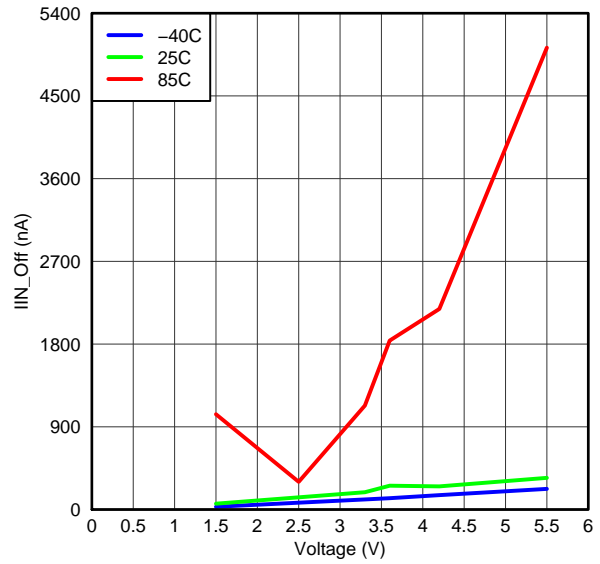

Figure 7.

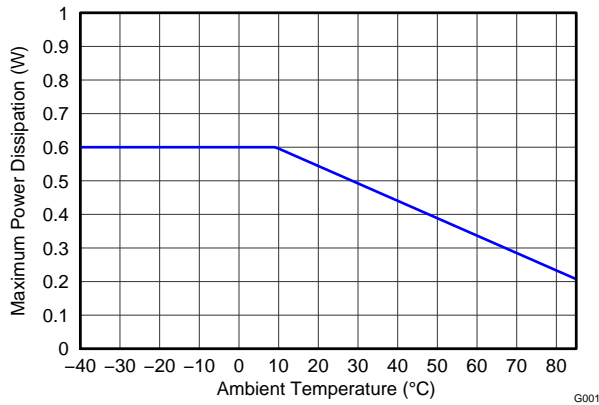

Figure 8. Allowable Power Dissipation

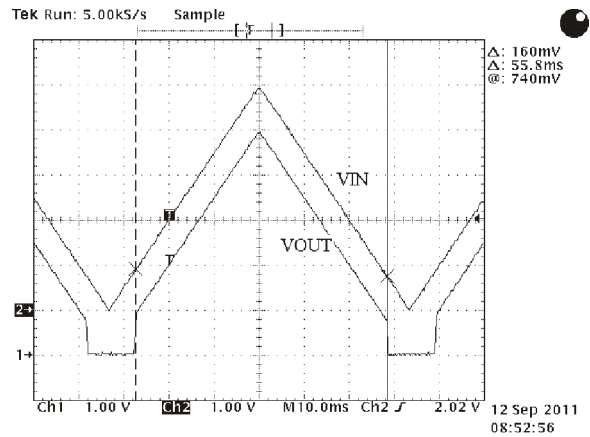

Figure 9. ULVO Response IOUT = -100mA

TYPICAL CHARACTERISTICS (continued)

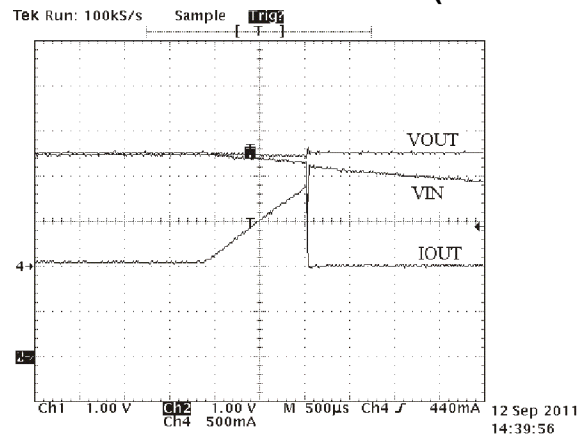

Figure 10. Reverse Current Protection $V_{OUT} = 3.3V$, $V_{IN} = 3.3V$ Decreasing to 0V

TYPICAL AC CHARACTERISTICS FOR TPS22910A

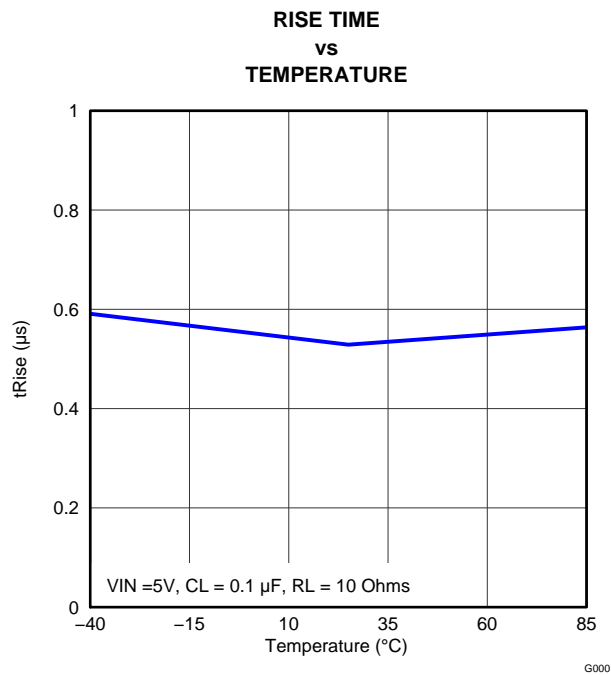

Figure 11.

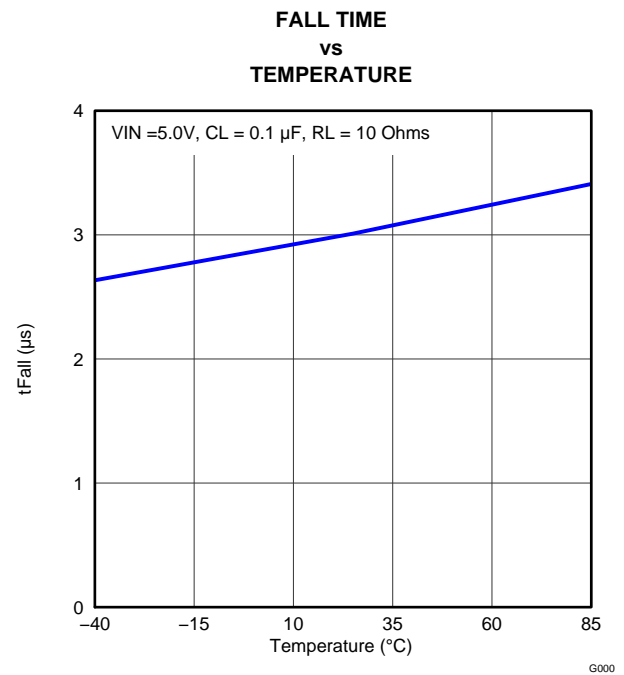

Figure 12.

TYPICAL CHARACTERISTICS (continued)

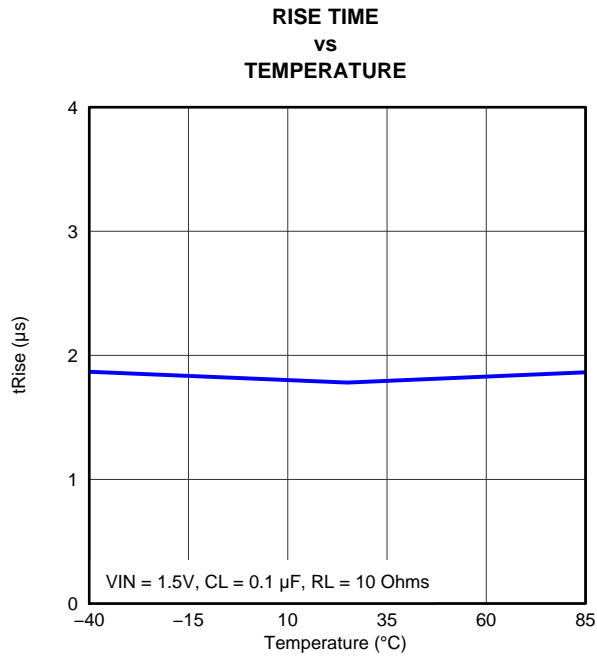

Figure 13.

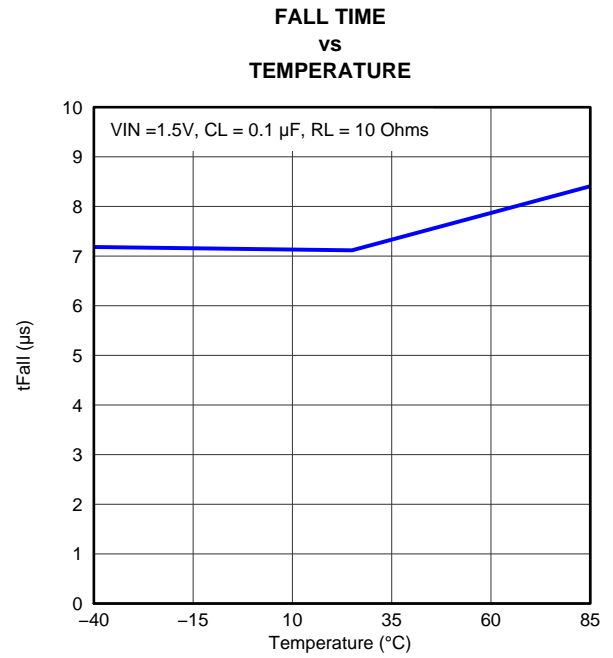

Figure 14.

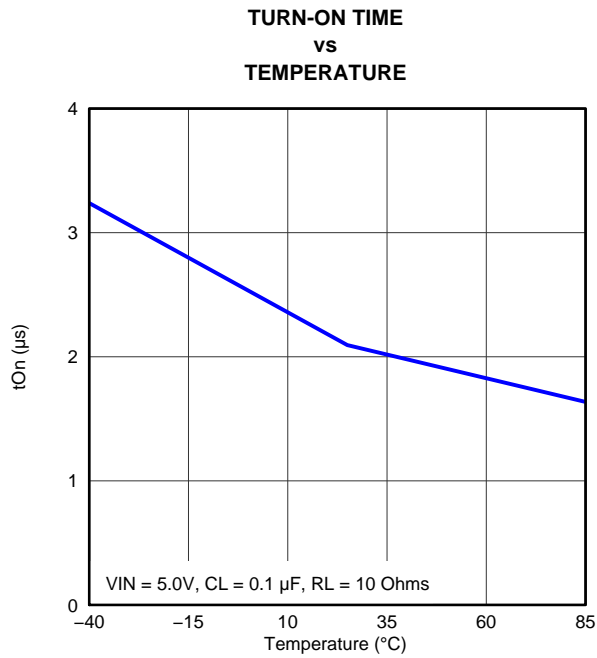

Figure 15.

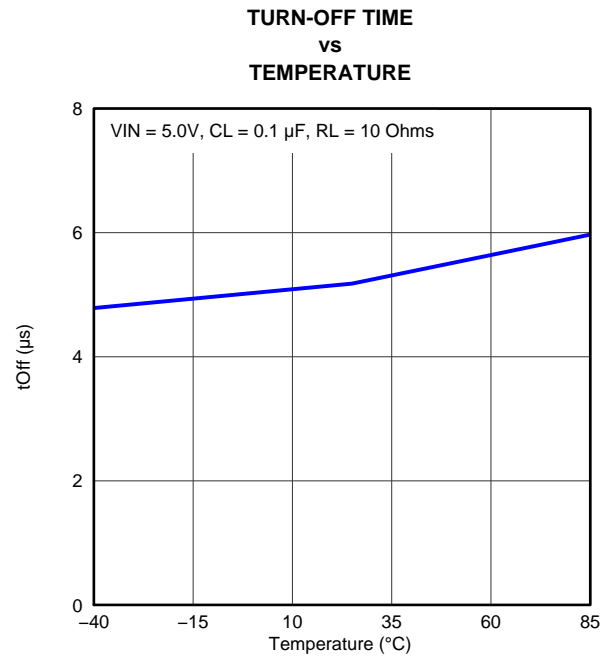

Figure 16.

TYPICAL CHARACTERISTICS (continued)

**TURN-ON TIME
vs
TEMPERATURE**

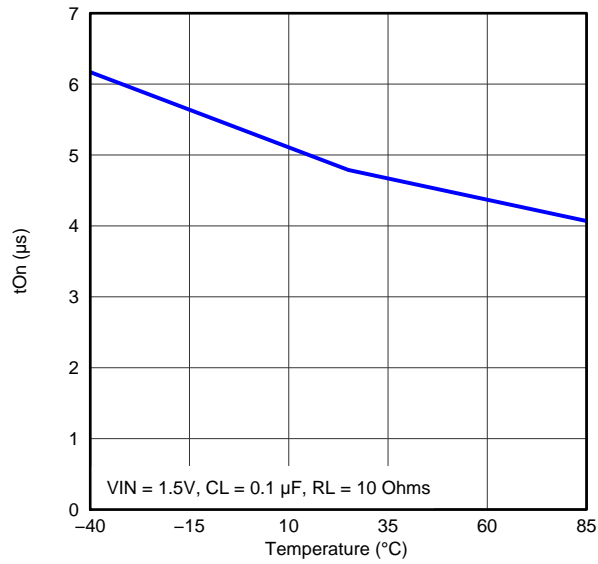

Figure 17.

**TURN-OFF TIME
vs
TEMPERATURE**

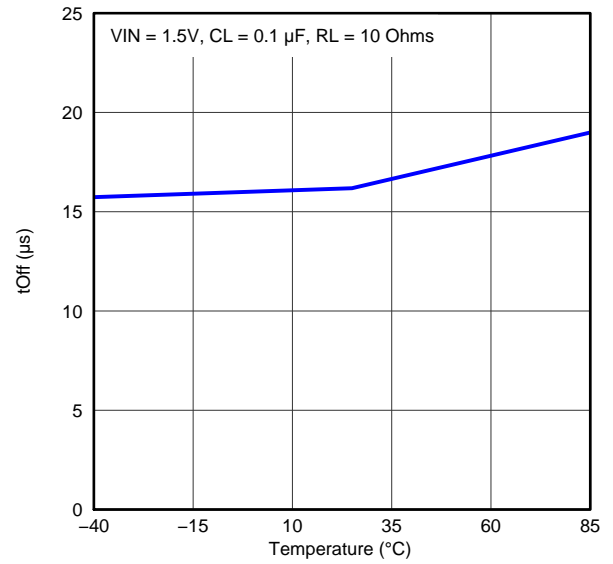

Figure 18.

**RISE TIME
vs
INPUT VOLTAGE**

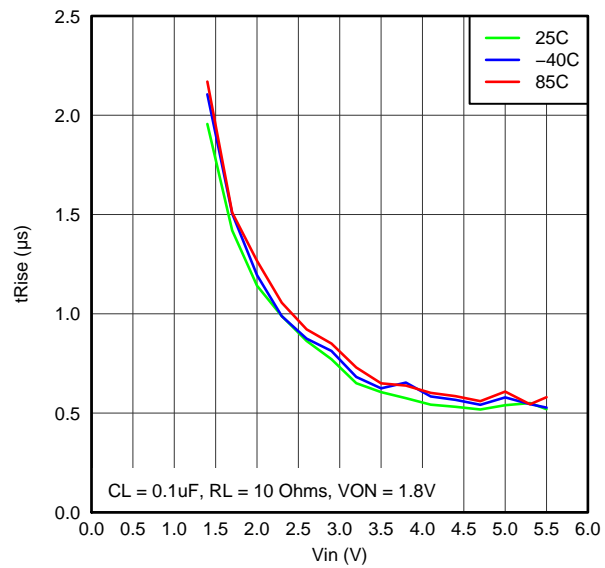

Figure 19.

TYPICAL CHARACTERISTICS (continued)

TURN-ON RESPONSE

$V_{IN} = 5V, T_A = 25^\circ C, C_{IN} = 10\mu F, C_L = 0.1\mu F, R_L = 10\Omega$

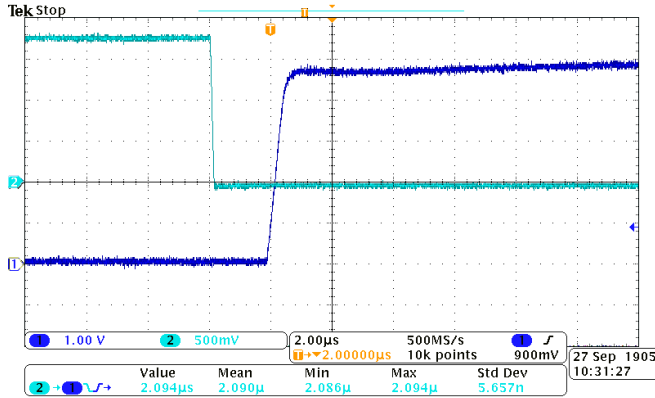

Figure 20.

TURN-OFF RESPONSE

$V_{IN} = 5V, T_A = 25^\circ C, C_{IN} = 10\mu F, C_L = 0.1\mu F, R_L = 10\Omega$

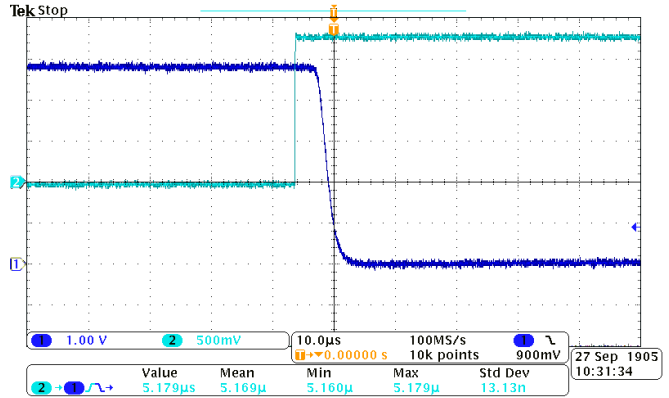

Figure 21.

TURN-ON RESPONSE TIME

$V_{IN} = 5V, T_A = 25^\circ C, C_{IN} = 10\mu F, C_L = 1\mu F, R_L = 10\Omega$

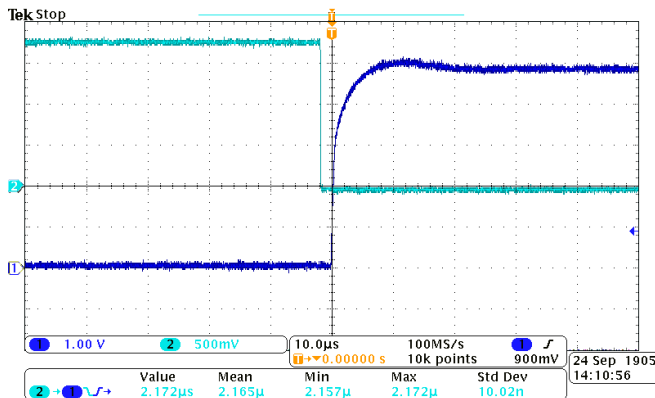

Figure 22.

TURN-OFF RESPONSE TIME

$V_{IN} = 5V, T_A = 25^\circ C, C_{IN} = 10\mu F, C_L = 1\mu F, R_L = 10\Omega$

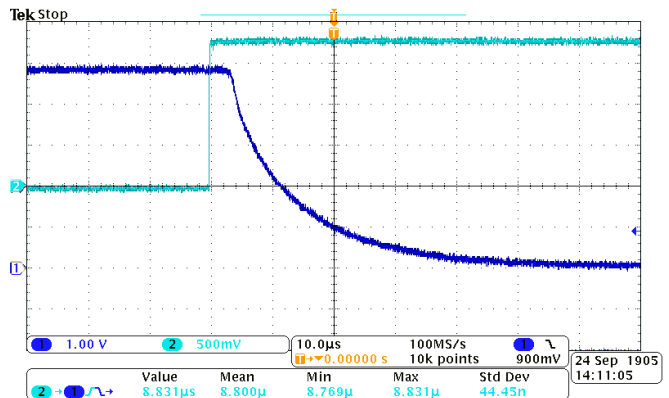

Figure 23.

TURN-ON RESPONSE TIME

$V_{IN} = 1.5V, T_A = 25^\circ C, C_{IN} = 10\mu F, C_L = 0.1\mu F, R_L = 10\Omega$

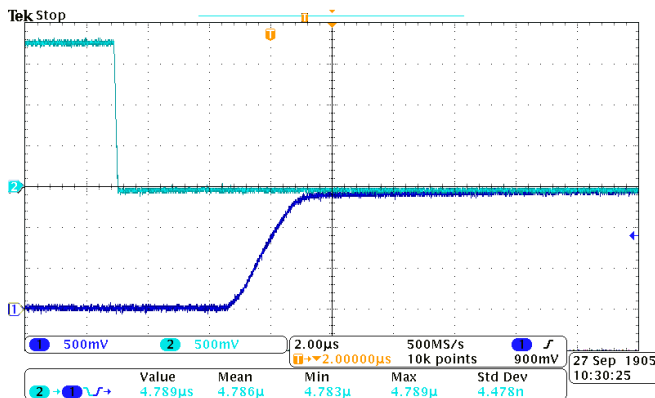

Figure 24.

TURN-OFF RESPONSE TIME

$V_{IN} = 1.5V, T_A = 25^\circ C, C_{IN} = 10\mu F, C_L = 0.1\mu F, R_L = 10\Omega$

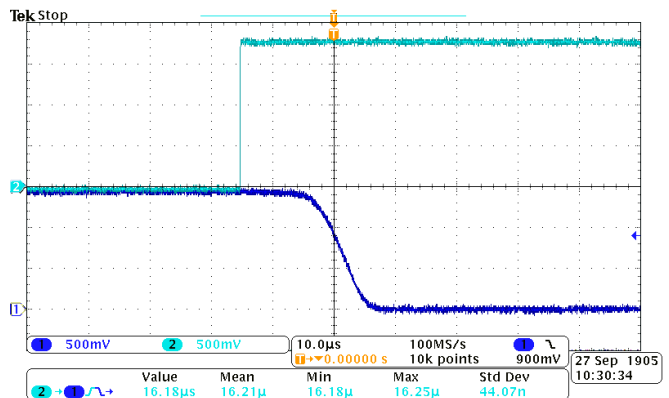

Figure 25.

TYPICAL CHARACTERISTICS (continued)

TURN-ON RESPONSE TIME

$V_{IN} = 1.5V$, $T_A = 25^\circ C$, $C_{IN} = 10\mu F$, $C_L = 1\mu F$, $R_L = 10\Omega$

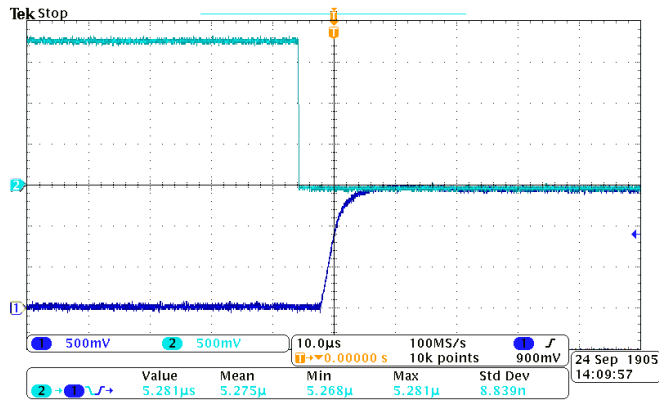

Figure 26.

TURN-OFF RESPONSE TIME

$V_{IN} = 1.5V$, $T_A = 25^\circ C$, $C_{IN} = 10\mu F$, $C_L = 1\mu F$, $R_L = 10\Omega$

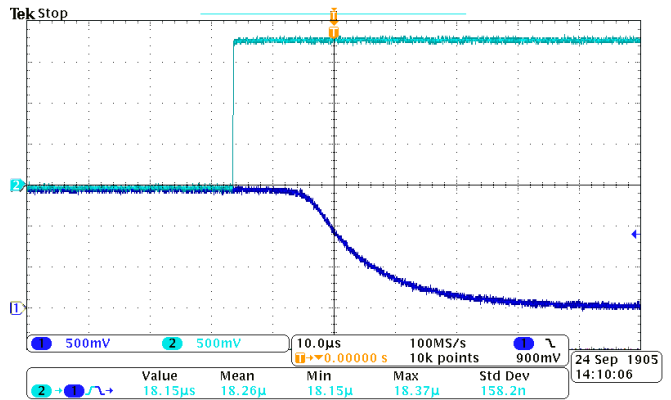

Figure 27.

APPLICATION INFORMATION

On/Off Control

The ON pin controls the state of the switch. Asserting ON low enables the switch. ON is active low and has a low threshold, making it capable of interfacing with low-voltage signals. The ON pin is compatible with standard GPIO logic threshold. It can be used with any microcontroller with 1.2-V, 1.8-V, 2.5-V or 3.3-V GPIO.

Input Capacitor

To limit the voltage drop on the input supply caused by transient inrush currents, when the switch turns on into a discharged load capacitor or short-circuit, a capacitor needs to be placed between VIN and GND. A 1- μ F ceramic capacitor, C_{IN}, placed close to the pins is usually sufficient. Higher values of C_{IN} can be used to further reduce the voltage drop.

Output Capacitor

A C_{IN} to C_L ratio of 10 to 1 is recommended for minimizing V_{IN} dip caused by inrush currents during startup. Devices with faster rise times may require a larger ratio to minimize V_{IN} dip.

Under-Voltage Lockout

Under-voltage lockout protection turns off the switch if the input voltage drops below the under-voltage lockout threshold. During under-voltage lockout (UVLO), if the voltage level at V_{OUT} exceeds the voltage level at V_{IN} by the Reverse Current Voltage Threshold (V_{RVP}), the body diode will be disengaged to prevent any current flow to V_{IN}. With the ON pin active, the input voltage rising above the under-voltage lockout threshold will cause a controlled turn-on of the switch to limit current over-shoot.

Reverse Current Protection

In a scenario where V_{OUT} is greater than V_{IN}, there is potential for reverse current to flow through the pass FET or the body diode. The TPS22910 monitors V_{IN} and V_{OUT} voltage levels. When the reverse current voltage threshold (V_{RVP}) is exceeded, the switch is disabled (within 10 μ s typ). Additionally, the body diode is disengaged so as to prevent any reverse current flow to V_{IN}. The FET, and the output (V_{OUT}), will resume normal operation when the reverse current scenario is no longer present.

Use the following formula to calculate the amount of reverse current for a particular application:

$$I_{RC} = \frac{0.044V}{R_{ON(VIN)}}$$

Where,

I_{RC} is the amount of reverse current,

R_{ON(VIN)} is the on-resistance at the VIN of the reverse current condition.

Board Layout

For best performance, all traces should be as short as possible. To be most effective, the input and output capacitors should be placed close to the device to minimize the effects that parasitic trace inductances may have on normal operation. Using wide traces for V_{IN}, V_{OUT}, and GND helps minimize the parasitic electrical effects along with minimizing the case to ambient thermal impedance.

REVISION HISTORY

Changes from Original (November 2011) to Revision A Page

- Deleted Quick Output Discharge Transistor from FEATURES. [1](#)

Changes from Revision A (March 2012) to Revision B Page

- Changed "active high" description for ON pin to "active low" in PIN FUNCTIONS table. [2](#)

PACKAGING INFORMATION

Orderable Device	Status ⁽¹⁾	Package Type	Package Drawing	Pins	Package Qty	Eco Plan ⁽²⁾	Lead/ Ball Finish	MSL Peak Temp ⁽³⁾	Samples (Requires Login)
TPS22910AYZVR	ACTIVE	DSBGA	YZV	4	3000	Green (RoHS & no Sb/Br)	SNAGCU	Level-1-260C-UNLIM	
TPS22910AYZVT	ACTIVE	DSBGA	YZV	4	250	Green (RoHS & no Sb/Br)	SNAGCU	Level-1-260C-UNLIM	

TAPE AND REEL INFORMATION

REEL DIMENSIONS

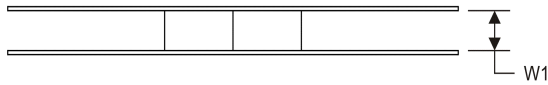
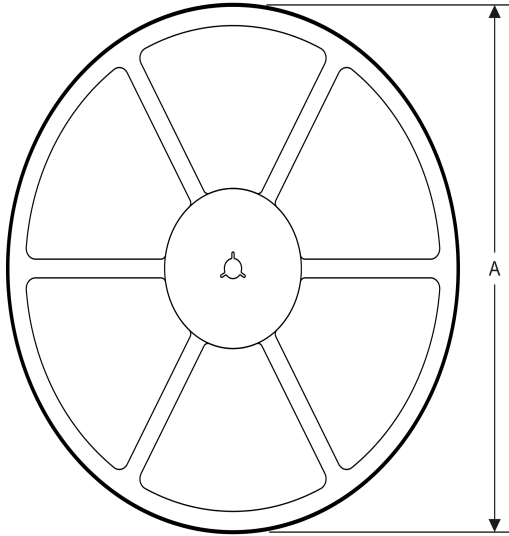

TAPE DIMENSIONS

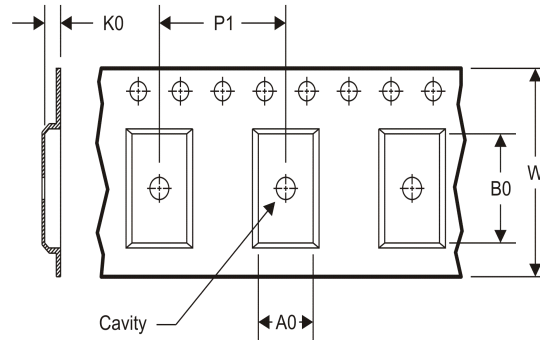

A0	Dimension designed to accommodate the component width
B0	Dimension designed to accommodate the component length
K0	Dimension designed to accommodate the component thickness
W	Overall width of the carrier tape
P1	Pitch between successive cavity centers

TAPE AND REEL INFORMATION

*All dimensions are nominal

Device	Package Type	Package Drawing	Pins	SPQ	Reel Diameter (mm)	Reel Width W1 (mm)	A0 (mm)	B0 (mm)	K0 (mm)	P1 (mm)	W (mm)	Pin1 Quadrant
TPS22910AYZVR	DSBGA	YZV	4	3000	178.0	9.2	1.0	1.0	0.63	4.0	8.0	Q1
TPS22910AYZVT	DSBGA	YZV	4	250	178.0	9.2	1.0	1.0	0.63	4.0	8.0	Q1

PACKAGE MATERIALS INFORMATION

25-Apr-2012

TAPE AND REEL BOX DIMENSIONS

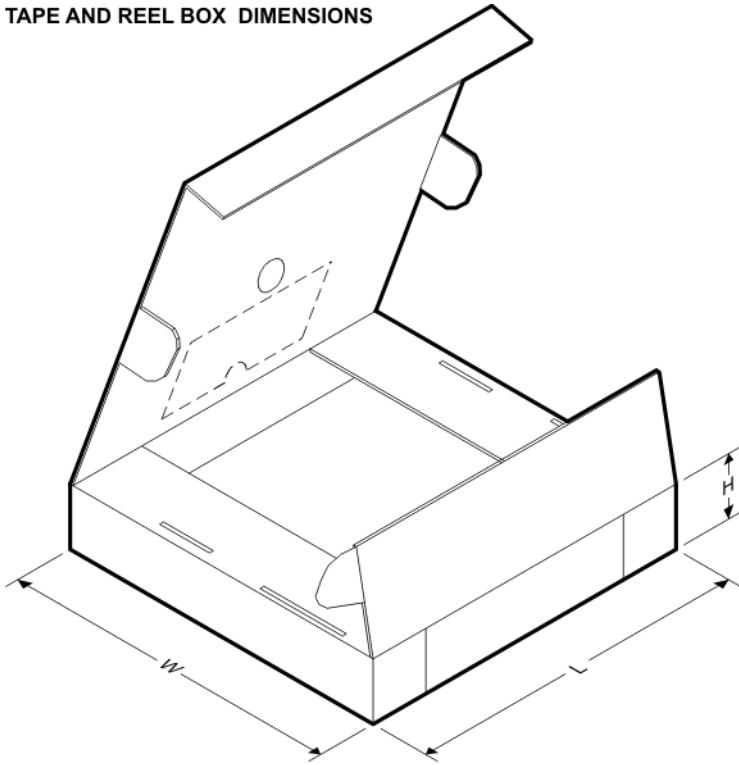

*All dimensions are nominal

Device	Package Type	Package Drawing	Pins	SPQ	Length (mm)	Width (mm)	Height (mm)
TPS22910AYZVR	DSBGA	YZV	4	3000	220.0	220.0	35.0
TPS22910AYZVT	DSBGA	YZV	4	250	220.0	220.0	35.0

YZV (S-XBGA-N4)

DIE-SIZE BALL GRID ARRAY

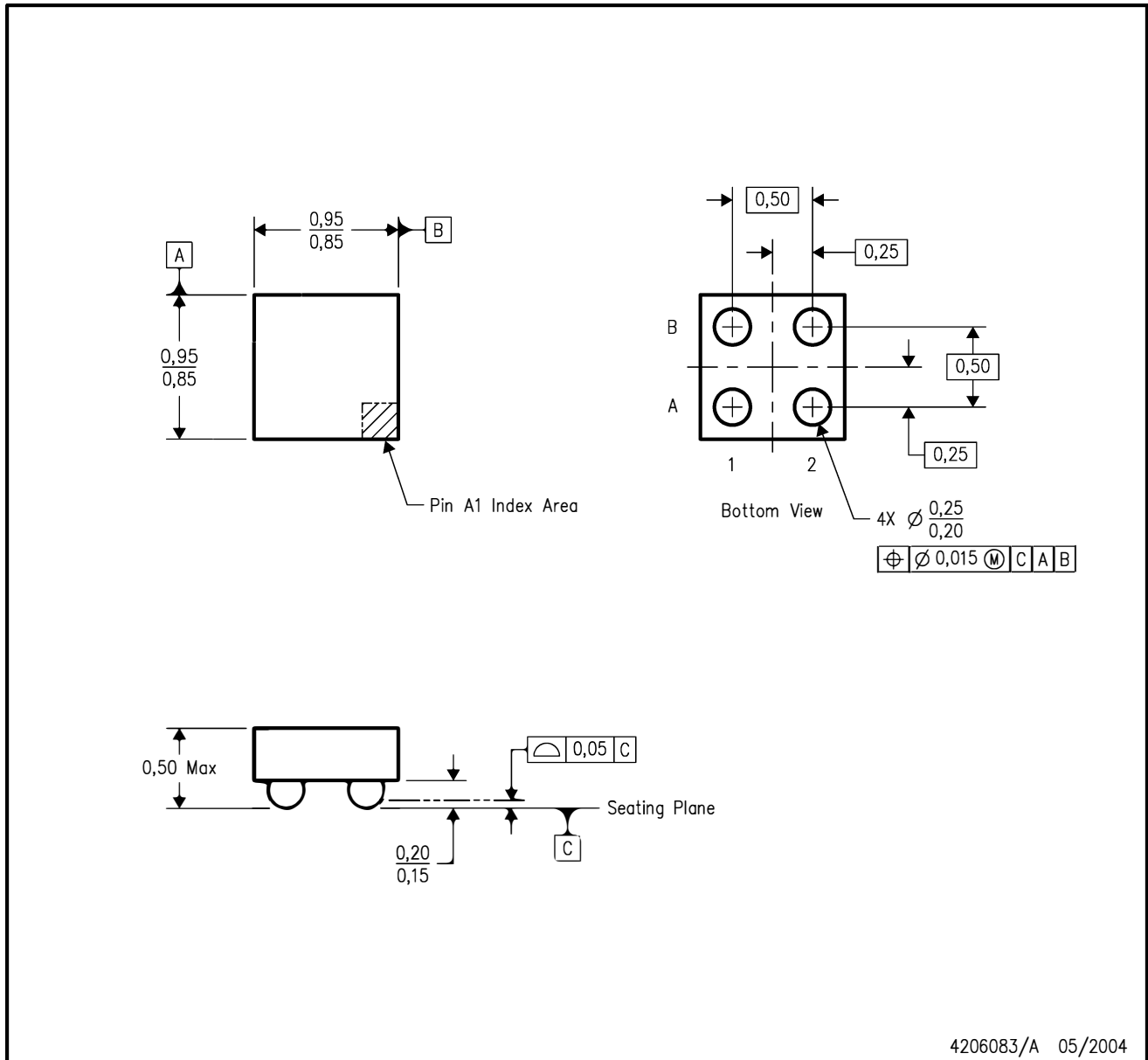

- NOTES:
- A. All linear dimensions are in millimeters.
 - B. This drawing is subject to change without notice.
 - C. NanoFree™ package configuration.
 - D. This package contains lead-free balls. Refer to the 4 YEV package (drawing 4206082) for tin-lead (SnPb) balls.