

TPS56220x 4.5-V to 17-V Input, 2-A Synchronous Step-Down Voltage Regulator in 6-Pin SOT-23

1 Features

- TPS562201 and TPS562208 2-A converter integrated 140-mΩ and 84-mΩ FETs
- D-CAP2™ mode control with fast transient response
- Input voltage range: 4.5 V to 17 V
- Output voltage range: 0.76 V to 7 V
- Pulse-skip mode (TPS562201) or continuous current mode (TPS562208)
- 580-kHz Switching frequency
- Low shutdown current less than 10 μA
- 2% Feedback voltage accuracy (25°C)
- Start-up from pre-biased output voltage
- Cycle-by-cycle overcurrent limit
- Hiccup-mode overcurrent protection
- Non-latch UVP and TSD protections
- Fixed soft start: 1.0 ms

2 Applications

- [Digital TV power supply](#)
- [High definition Blu-ray™ disc players](#)
- [Networking home terminal](#)
- [Digital set-top box \(STB\)](#)
- [Surveillance](#)

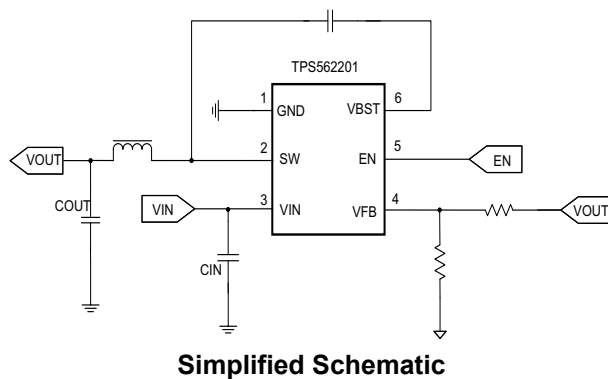

3 Description

The TPS562201 and TPS562208 are simple, easy-to-use, 2-A synchronous step-down converters in SOT-23 package.

The devices are optimized to operate with minimum external component counts and also optimized to achieve low standby current.

These switch mode power supply (SMPS) devices employ D-CAP2 mode control providing a fast transient response and supporting both low equivalent series resistance (ESR) output capacitors such as specialty polymer and ultra-low ESR ceramic capacitors with no external compensation components.

The TPS562201 operates in pulse skip mode, which maintains high efficiency during light load operation. The TPS562201 and TPS562208 are available in a 6-pin 1.6 × 2.9 (mm) SOT (DDC) package and specified from –40°C to 125°C of junction temperature.

Device Information

| PART NUMBER | PACKAGE ⁽¹⁾ | BODY SIZE (NOM) |
|-------------|------------------------|-------------------|
| TPS562201 | SOT (6) | 1.60 mm × 2.90 mm |
| TPS562208 | | |

- (1) For all available packages, see the orderable addendum at the end of the data sheet.

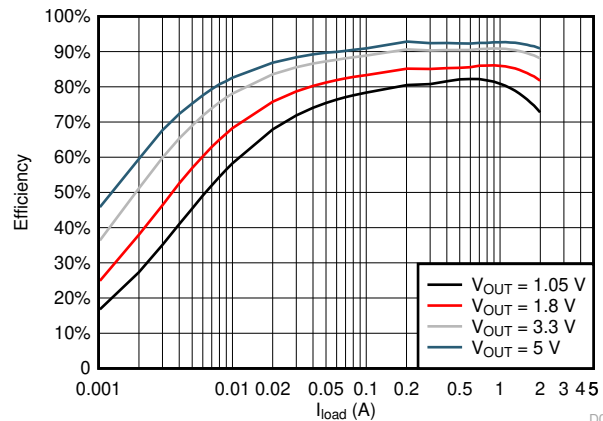

TPS562201 Efficiency

D021

Table of Contents

| | | | |
|--|---|--|----|
| 1 Features | 1 | 7.4 Device Functional Modes..... | 10 |
| 2 Applications | 1 | 8 Application and Implementation | 12 |
| 3 Description | 1 | 8.1 Application Information..... | 12 |
| 4 Revision History | 2 | 8.2 Typical Application..... | 12 |
| 5 Pin Configuration and Functions | 3 | 9 Power Supply Recommendations | 18 |
| Pin Functions..... | 3 | 10 Layout | 18 |
| 6 Specifications | 4 | 10.1 Layout Guidelines..... | 18 |
| 6.1 Absolute Maximum Ratings..... | 4 | 10.2 Layout Example..... | 18 |
| 6.2 ESD Ratings..... | 4 | 11 Device and Documentation Support | 19 |
| 6.3 Recommended Operating Conditions..... | 4 | 11.1 Receiving Notification of Documentation Updates.. | 19 |
| 6.4 Thermal Information..... | 4 | 11.2 Support Resources..... | 19 |
| 6.5 Electrical Characteristics..... | 5 | 11.3 Trademarks..... | 19 |
| 6.6 Typical Characteristics..... | 6 | 11.4 Electrostatic Discharge Caution..... | 19 |
| 7 Detailed Description | 9 | 11.5 Glossary..... | 19 |
| 7.1 Overview..... | 9 | 12 Mechanical, Packaging, and Orderable Information | 19 |
| 7.2 Functional Block Diagram..... | 9 | | |
| 7.3 Feature Description..... | 9 | | |

4 Revision History

NOTE: Page numbers for previous revisions may differ from page numbers in the current version.

| Changes from Revision A (December 2017) to Revision B (September 2020) | Page |
|---|-------------|
| • Updated the numbering format for tables, figures and cross-references throughout the document. | 1 |
| • Changed to 'TPS562201' from 'TPS563201' in "TPS562201 Efficiency"..... | 1 |
| • Changed 'TPS563201' to 'TPS562201' in "TPS562201 Supply Current vs Junction Temperature"..... | 6 |
| • Changed to 'TPS562208' from 'TPS563208' and 'TPS562201' from 'TPS563208' in "Line Regulation"..... | 15 |
| • Changed to 'TPS562201' from 'TPS563201' in "TPS562201 Efficiency, $V_{OUT} = 1.05\text{ V}$ "..... | 15 |

| Changes from Revision * (December 2015) to Revision A (December 2017) | Page |
|--|-------------|
| • Deleted the OVP comparator from the block diagram. | 9 |

5 Pin Configuration and Functions

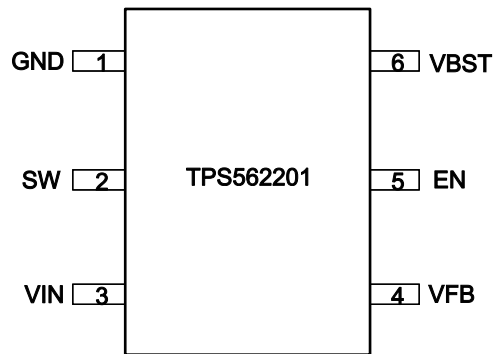

Figure 5-1. 6-Pin SOT DDC Package (Top View)

Pin Functions

| PIN | | DESCRIPTION |
|------|-----|---|
| NAME | NO. | |
| GND | 1 | Ground pin source terminal of low-side power NFET as well as the ground terminal for controller circuit. Connect sensitive VFB to this GND at a single point. |
| SW | 2 | Switch node connection between high-side NFET and low-side NFET |
| VIN | 3 | Input voltage supply pin. The drain terminal of high-side power NFET |
| VFB | 4 | Converter feedback input. Connect to output voltage with feedback resistor divider. |
| EN | 5 | Enable input control. Active high and must be pulled up to enable the device |
| VBST | 6 | Supply input for the high-side NFET gate drive circuit. Connect a 0.1- μ F capacitor between VBST and SW pins. |

6 Specifications

6.1 Absolute Maximum Ratings

over operating free-air temperature range (unless otherwise noted)⁽¹⁾

| | | MIN | MAX | UNIT |
|--|------------------------|------|-----|------|
| Input voltage | VIN, EN | -0.3 | 19 | V |
| | VBST | -0.3 | 25 | V |
| | VBST (10-ns transient) | -0.3 | 27 | V |
| | VBST (vs SW) | -0.3 | 6.5 | V |
| | VFB | -0.3 | 6.5 | V |
| | SW | -2 | 19 | V |
| | SW (10 ns transient) | -3.5 | 21 | V |
| Operating junction temperature, T _J | | -40 | 150 | °C |
| Storage temperature, T _{stg} | | -55 | 150 | °C |

(1) Stresses beyond those listed under *Absolute Maximum Ratings* may cause permanent damage to the device. These are stress ratings only, which do not imply functional operation of the device at these or any other conditions beyond those indicated under *Recommended Operating Conditions*. Exposure to absolute-maximum-rated conditions for extended periods may affect device reliability.

6.2 ESD Ratings

| | | | VALUE | UNIT |
|--------------------|-------------------------|--|-------|------|
| V _(ESD) | Electrostatic discharge | Human-body model (HBM), per ANSI/ESDA/JEDEC JS-001 ⁽¹⁾ | ±3000 | V |
| | | Charged-device model (CDM), per JEDEC specification JESD22-C101 ⁽²⁾ | ±1500 | |

(1) JEDEC document JEP155 states that 500-V HBM allows safe manufacturing with a standard ESD control process.

(2) JEDEC document JEP157 states that 250-V CDM allows safe manufacturing with a standard ESD control process.

6.3 Recommended Operating Conditions

over operating free-air temperature range (unless otherwise noted)

| | | MIN | MAX | UNIT | |
|-----------------|--------------------------------|------------------------|------|------|---|
| V _{IN} | Supply input voltage | 4.5 | 17 | V | |
| V _I | Input voltage | VBST | -0.1 | 23 | V |
| | | VBST (10-ns transient) | -0.1 | 26 | |
| | | VBST(vs SW) | -0.1 | 6.0 | |
| | | EN | -0.1 | 17 | |
| | | VFB | -0.1 | 5.5 | |
| | | SW | -1.8 | 17 | |
| | | SW (10 ns transient) | -3.5 | 20 | |
| T _J | Operating junction temperature | -40 | 125 | °C | |

6.4 Thermal Information

| THERMAL METRIC ⁽¹⁾ | | TPS562201 and TPS562208 | UNIT |
|-------------------------------|--|----------------------------|------|
| | | DDC (SOT) | |
| | | 6 PINS | |
| R _{θJA} | Junction-to-ambient thermal resistance | 90.8 | °C/W |
| R _{θJC(top)} | Junction-to-case (top) thermal resistance | 42.3 | °C/W |
| R _{θJB} | Junction-to-board thermal resistance | 16.3 | °C/W |
| ψ _{JT} | Junction-to-top characterization parameter | 2.6 | °C/W |

| THERMAL METRIC ⁽¹⁾ | | TPS562201 and TPS562208 | | UNIT |
|-------------------------------|--|----------------------------|--|------|
| | | DDC (SOT) | | |
| | | 6 PINS | | |
| Ψ_{JB} | Junction-to-board characterization parameter | 16.3 | | °C/W |

(1) For more information about traditional and new thermal metrics, see the *Semiconductor and IC Package Thermal Metrics* application report, [SPRA953](#).

6.5 Electrical Characteristics

$T_J = -40^{\circ}\text{C}$ to 125°C , $V = 12\text{ V}$ (unless otherwise noted)

| PARAMETER | | TEST CONDITIONS | MIN | TYP | MAX | UNIT |
|---|---|---|-----------|-----|-----------|---------------|
| SUPPLY CURRENT | | | | | | |
| I_{VIN} | Operating – non-switching supply current | V_{IN} current, EN = 5 V, VFB = 0.8 V | TPS562201 | 380 | 520 | μA |
| | | | TPS562208 | 590 | 750 | |
| $I_{VINS\text{DN}}$ | Shutdown supply current | V_{IN} current, EN = 0 V | | 1 | 10 | μA |
| LOGIC THRESHOLD | | | | | | |
| V_{ENH} | EN high-level input voltage | EN | 1.6 | | | V |
| V_{ENL} | EN low-level input voltage | EN | | | 0.8 | V |
| R_{EN} | EN pin resistance to GND | $V_{\text{EN}} = 12\text{ V}$ | 225 | 400 | 900 | k Ω |
| VFB VOLTAGE AND DISCHARGE RESISTANCE | | | | | | |
| | VFB threshold voltage | $V_O = 1.05\text{ V}$, $I_O = 10\text{ mA}$, Eco-mode™ operation | | 774 | | mV |
| V_{FBTH} | VFB threshold voltage | $V_O = 1.05\text{ V}$, continuous mode operation | 749 | 768 | 787 | mV |
| I_{VFB} | VFB input current | $V_{\text{FB}} = 0.8\text{ V}$ | | 0 | ± 0.1 | μA |
| MOSFET | | | | | | |
| $R_{\text{DS(on)h}}$ | High-side switch resistance | $T_A = 25^{\circ}\text{C}$, $V_{\text{BST}} - \text{SW} = 5.5\text{ V}$ | | 140 | | m Ω |
| $R_{\text{DS(on)l}}$ | Low-side switch resistance | $T_A = 25^{\circ}\text{C}$ | | 84 | | m Ω |
| CURRENT LIMIT | | | | | | |
| I_{ocL} | Current limit | DC current, $V_{\text{OUT}} = 1.05\text{ V}$, $L_1 = 2.2\text{ }\mu\text{H}$ | 2.4 | 3.2 | 4.0 | A |
| THERMAL SHUTDOWN | | | | | | |
| T_{SDN} | Thermal shutdown threshold ⁽¹⁾ | Shutdown temperature | | 160 | | °C |
| | | Hysteresis | | 25 | | |
| ON-TIME TIMER CONTROL | | | | | | |
| $t_{\text{OFF(MIN)}}$ | Minimum off time | VFB = 0.5 V | | 220 | 310 | ns |
| SOFT START | | | | | | |
| t_{SS} | Soft-start time | Internal soft-start time | | 1.0 | | ms |
| Frequency | | | | | | |
| F_{sw} | Switching frequency | $V_{\text{IN}} = 12\text{ V}$, $V_O = 1.05\text{ V}$, FCCM mode | | 580 | | kHz |
| OUTPUT UNDERVOLTAGE AND OVERVOLTAGE PROTECTION | | | | | | |
| V_{UVP} | Output UVP threshold | Hiccup detect (H > L) | | 65% | | |
| $T_{\text{HICCUP_WAIT}}$ | Hiccup wait time | | | 1.8 | | ms |
| $T_{\text{HICCUP_RE}}$ | Hiccup time before restart | | | 15 | | ms |
| UVLO | | | | | | |
| UVLO | UVLO threshold | Wake up VIN voltage | | 4.0 | 4.3 | V |
| | | Shut down VIN voltage | 3.3 | 3.6 | | |
| | | Hysteresis VIN voltage | | 0.4 | | |

(1) Not production tested

6.6 Typical Characteristics

$V_{IN} = 12\text{ V}$ (unless otherwise noted)

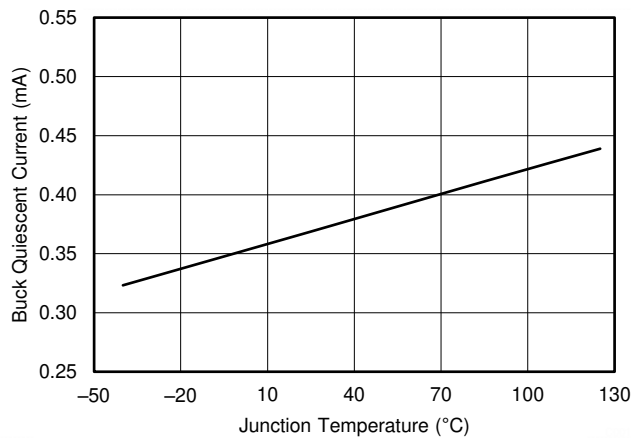

Figure 6-1. TPS562201 Supply Current vs Junction Temperature

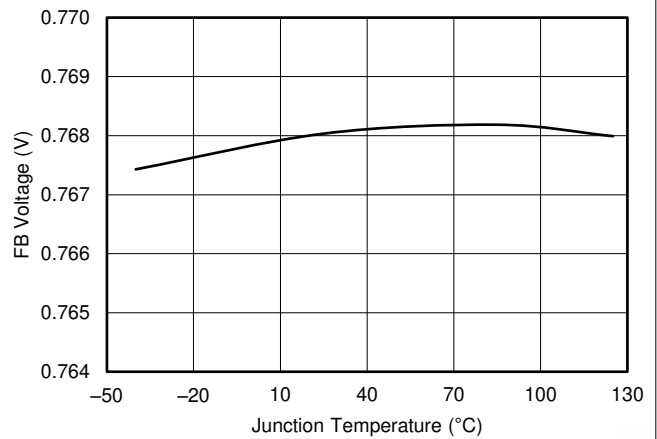

Figure 6-2. VFB Voltage vs Junction Temperature

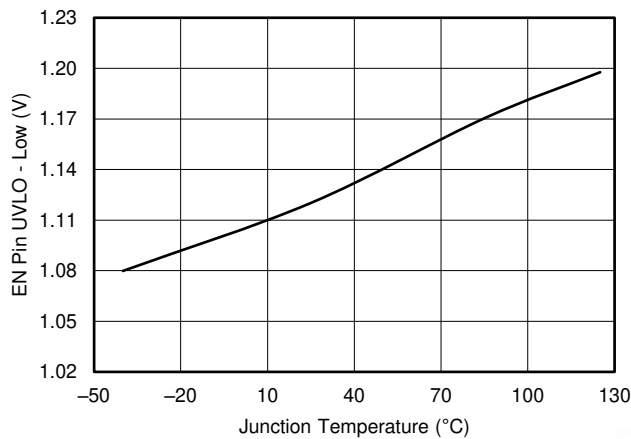

Figure 6-3. EN Pin UVLO Low Voltage vs Junction Temperature

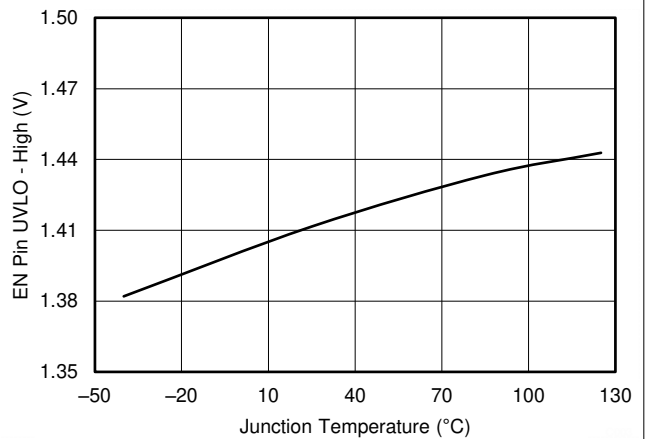

Figure 6-4. EN Pin UVLO High Voltage vs Junction Temperature

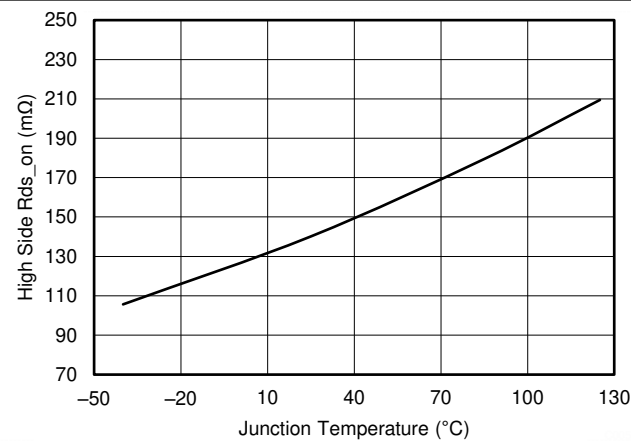

Figure 6-5. High-Side R_{ds-on} vs Junction Temperature

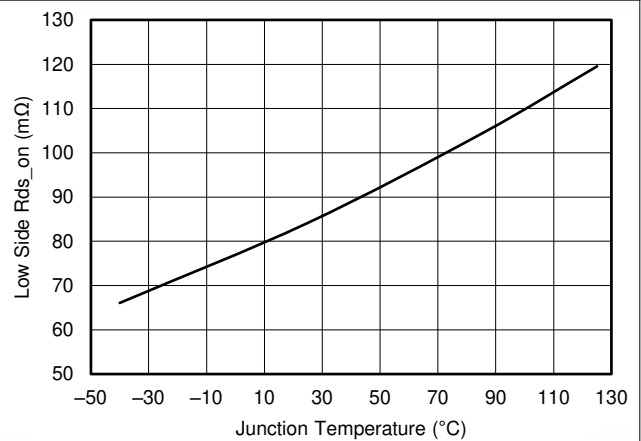

Figure 6-6. Low-Side R_{ds-on} vs Junction Temperature

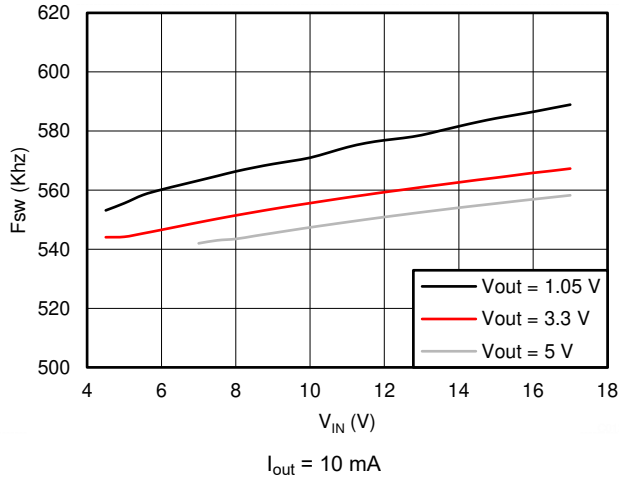

Figure 6-7. TPS562208 Switching Frequency vs Input Voltage

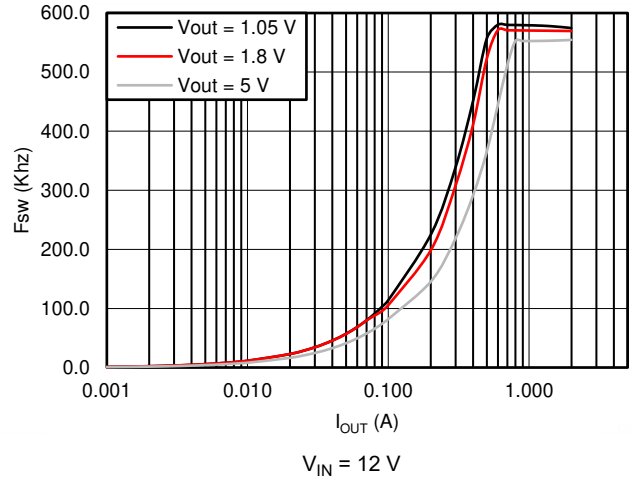

Figure 6-8. TPS562201 Switching Frequency vs Output Current

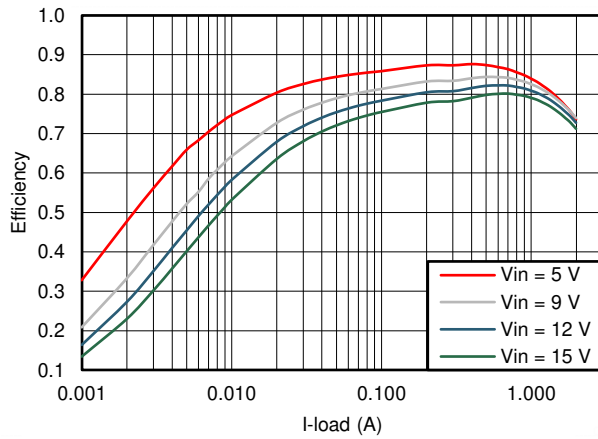

Figure 6-9. TPS562201 $V_{OUT} = 1.05\text{ V}$ Efficiency, $L = 2.2\ \mu\text{H}$

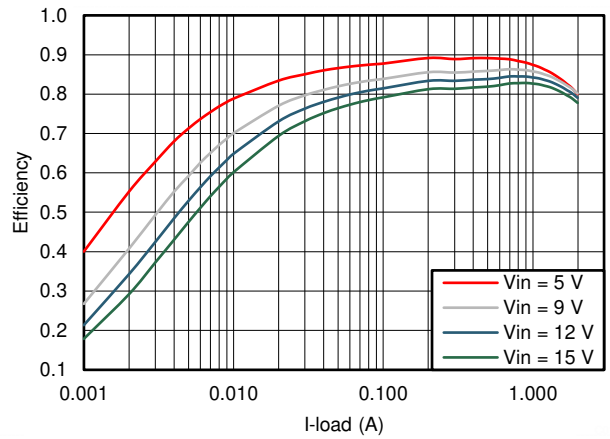

Figure 6-10. TPS562201 $V_{OUT} = 1.5\text{ V}$ Efficiency, $L = 2.2\ \mu\text{H}$

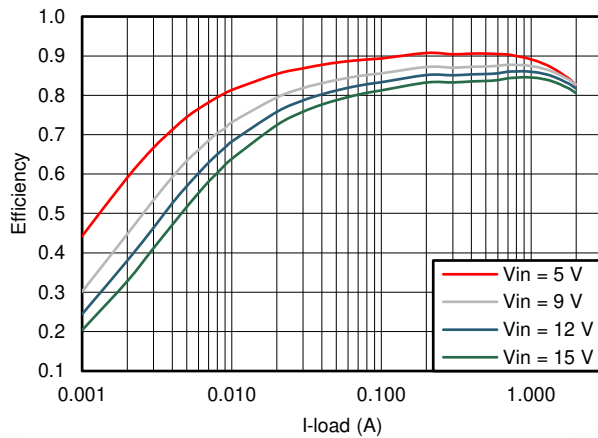

Figure 6-11. TPS562201 $V_{OUT} = 1.8\text{ V}$ Efficiency, $L = 2.2\ \mu\text{H}$

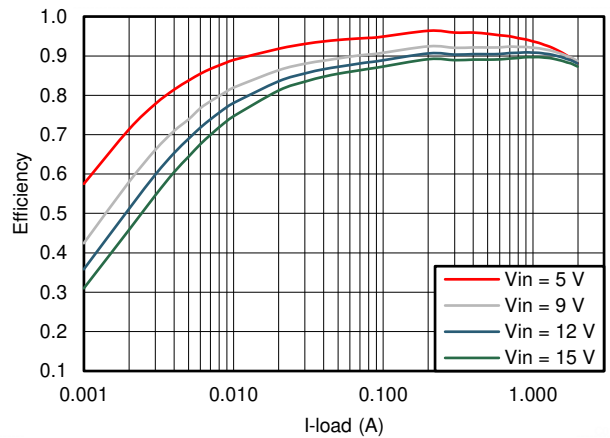

Figure 6-12. TPS562201 $V_{OUT} = 3.3\text{ V}$ Efficiency, $L = 3.3\ \mu\text{H}$

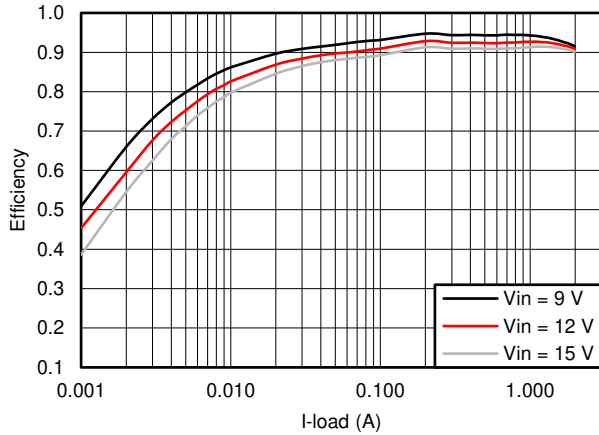

Figure 6-13. TPS562201 $V_{OUT} = 5\text{ V}$ Efficiency, $L = 3.3\ \mu\text{H}$

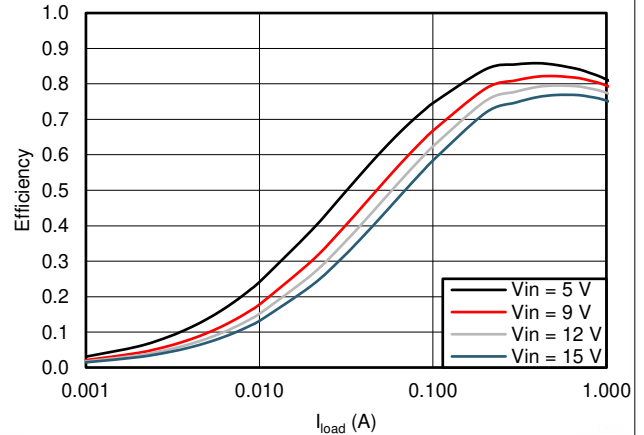

Figure 6-14. TPS562208 $V_{OUT} = 1.05\text{ V}$ Efficiency, $L = 2.2\ \mu\text{H}$

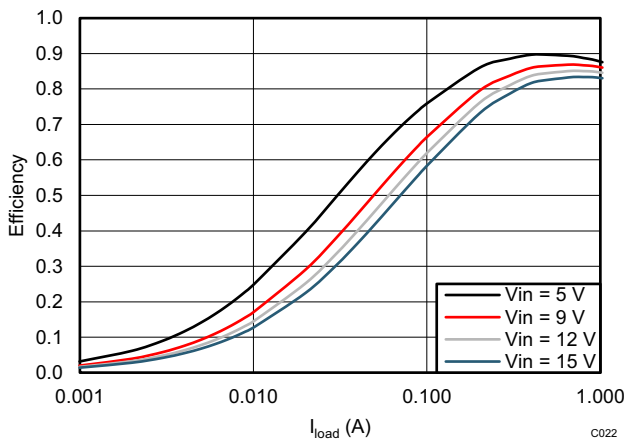

Figure 6-15. TPS562208 $V_{OUT} = 1.5\text{ V}$ Efficiency, $L = 2.2\ \mu\text{H}$

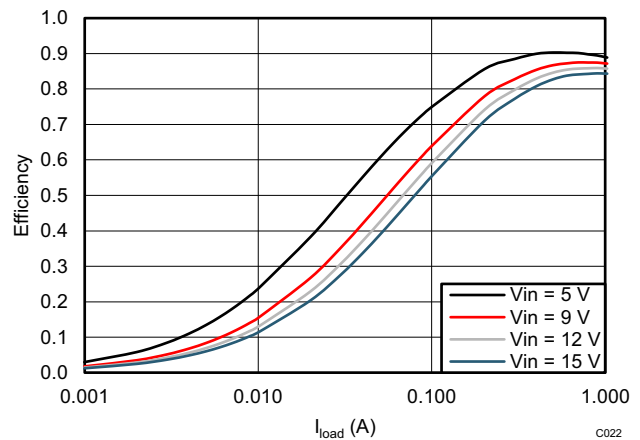

Figure 6-16. TPS562208 $V_{OUT} = 1.8\text{ V}$ Efficiency, $L = 2.2\ \mu\text{H}$

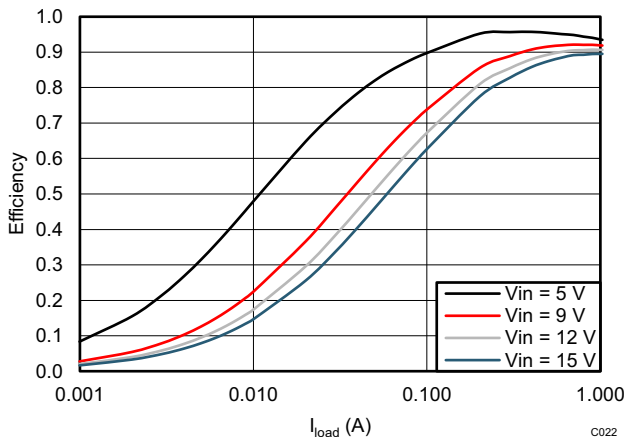

Figure 6-17. TPS562208 $V_{OUT} = 3.3\text{ V}$ Efficiency, $L = 2.2\ \mu\text{H}$

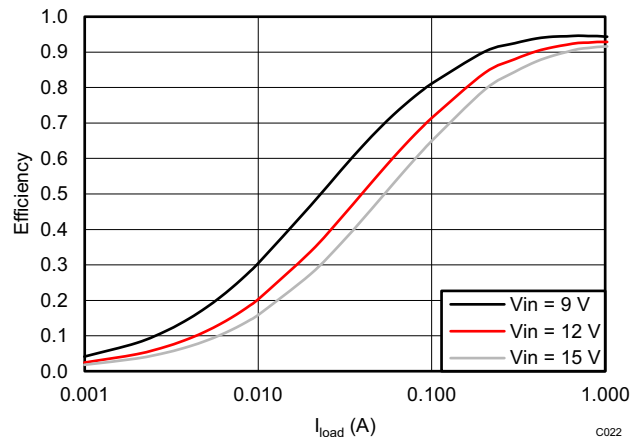

Figure 6-18. TPS562208 $V_{OUT} = 5\text{ V}$ Efficiency, $L = 3.3\ \mu\text{H}$

7 Detailed Description

7.1 Overview

The TPS562201 and TPS562208 are 2-A synchronous step-down converters. The proprietary D-CAP2 mode control supports low-ESR output capacitors, such as specialty polymer capacitors and multi-layer ceramic capacitors, without complex external compensation circuits. The fast transient response of D-CAP2 mode control can reduce the output capacitance required to meet a specific level of performance.

7.2 Functional Block Diagram

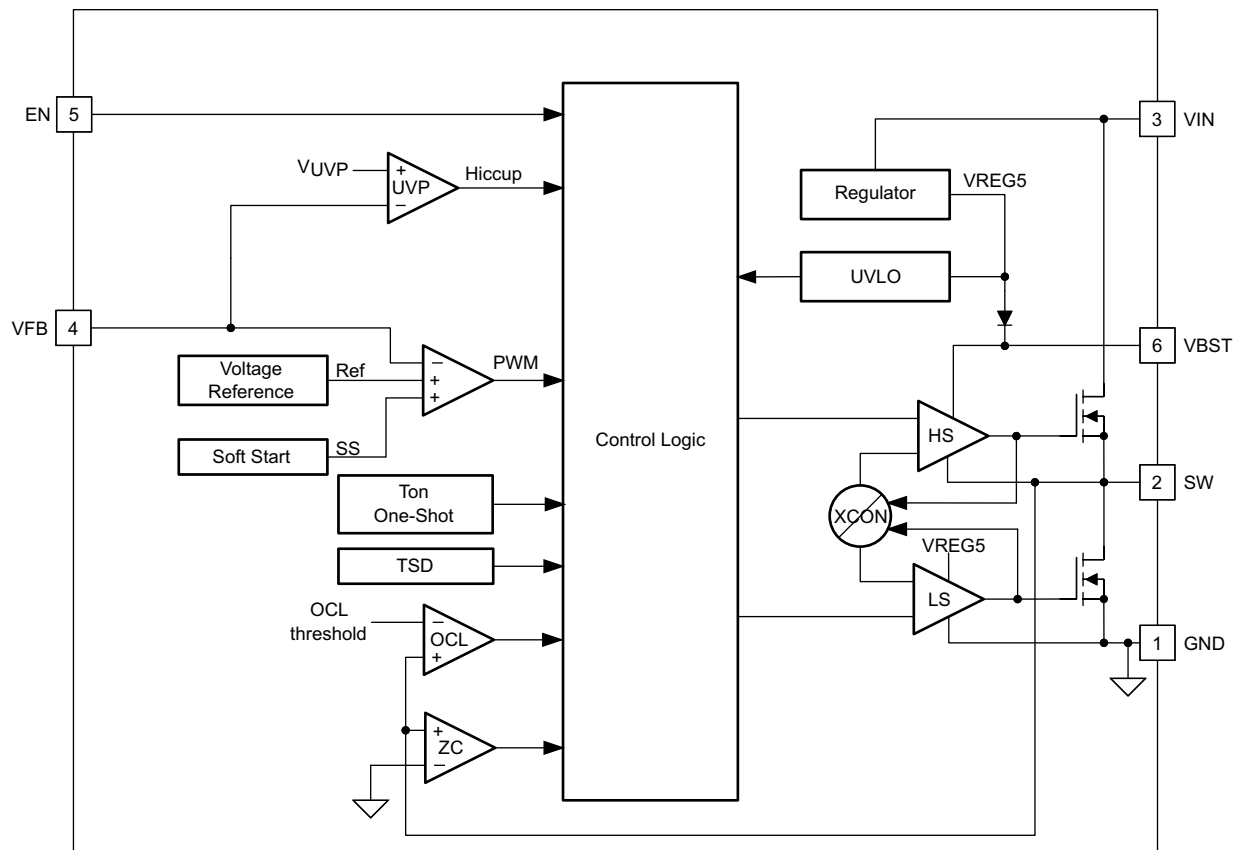

Copyright © 2017, Texas Instruments Incorporated

7.3 Feature Description

7.3.1 Adaptive On-Time Control and PWM Operation

The main control loop of the TPS562201 is adaptive on-time pulse width modulation (PWM) controller that supports a proprietary D-CAP2 mode control. The D-CAP2 mode control combines adaptive on-time control with an internal compensation circuit for pseudo-fixed frequency and low external component count configuration with both low ESR and ceramic output capacitors. It is stable even with virtually no ripple at the output.

At the beginning of each cycle, the high-side MOSFET is turned on. This MOSFET is turned off after internal one shot timer expires. This one shot duration is set proportional to the converter input voltage, V_{IN} , and inversely proportional to the output voltage, V_O , to maintain a pseudo-fixed frequency over the input voltage range, hence it is called adaptive on-time control. The one-shot timer is reset and the high-side MOSFET is turned on again when the feedback voltage falls below the reference voltage. An internal ramp is added to reference voltage to simulate output ripple, eliminating the need for ESR induced output ripple from D-CAP2 mode control.

7.3.2 Pulse Skip Control (TPS562201)

The TPS562201 and TPS562208 are designed with Advanced Eco-mode to maintain high light load efficiency. As the output current decreases from heavy load condition, the inductor current is also reduced and eventually

comes to point that its rippled valley touches zero level, which is the boundary between continuous conduction and discontinuous conduction modes. The rectifying MOSFET is turned off when the zero inductor current is detected. As the load current further decreases, the converter runs into discontinuous conduction mode. The on-time is kept almost the same as it was in the continuous conduction mode so that it takes longer time to discharge the output capacitor with smaller load current to the level of the reference voltage. This makes the switching frequency lower, proportional to the load current, and keeps the light load efficiency high. The transition point to the light load operation $I_{OUT(LL)}$ current can be calculated in [Equation 1](#).

$$I_{OUT(LL)} = \frac{1}{2 \times L \times f_{SW}} \times \frac{(V_{IN} - V_{OUT}) \times V_{OUT}}{V_{IN}} \quad (1)$$

7.3.3 Soft Start and Pre-Biased Soft Start

The TPS562201 and TPS562208 have an internal 1.0-ms soft start. When the EN pin becomes high, the internal soft-start function begins ramping up the reference voltage to the PWM comparator. If the output capacitor is pre-biased at start-up, the devices initiate switching and start ramping up only after the internal reference voltage becomes greater than the feedback voltage, VFB. This scheme ensures that the converters ramp up smoothly into regulation point.

7.3.4 Current Protection

The output overcurrent limit (OCL) is implemented using a cycle-by-cycle valley detect control circuit. The switch current is monitored during the OFF state by measuring the low-side FET drain to source voltage. This voltage is proportional to the switch current. To improve accuracy, the voltage sensing is temperature compensated.

During the on-time of the high-side FET switch, the switch current increases at a linear rate determined by V_{in} , V_{out} , the on-time, and the output inductor value. During the on-time of the low-side FET switch, this current decreases linearly. The average value of the switch current is the load current, I_{out} . If the monitored current is above the OCL level, the converter keeps the low-side FET on and delays the creation of a new set pulse, even the voltage feedback loop requires one, until the current level becomes OCL level or lower. In subsequent switching cycles, the on-time is set to a fixed value and the current is monitored in the same manner.

There are some important considerations for this type of over-current protection. The load current is higher than the overcurrent threshold by one half of the peak-to-peak inductor ripple current. Also, when the current is being limited, the output voltage tends to fall as the demanded load current can be higher than the current available from the converter. This can cause the output voltage to fall. When the VFB voltage falls below the UVP threshold voltage, the UVP comparator detects it, then the device will shut down after the UVP delay time (typically 24 μ s) and restart after the hiccup time (typically 15 ms).

When the overcurrent condition is removed, the output voltage returns to the regulated value.

7.3.5 Undervoltage Lockout (UVLO) Protection

UVLO protection monitors the internal regulator voltage. When the voltage is lower than UVLO threshold voltage, the device is shut off. This protection is non-latching.

7.3.6 Thermal Shutdown

The device monitors the temperature of itself. If the temperature exceeds the threshold value (typically 160°C), the device is shut off. This is a non-latch protection.

7.4 Device Functional Modes

7.4.1 Normal Operation

When the input voltage is above the UVLO threshold and the EN voltage is above the enable threshold, the TPS562200 can operate in their normal switching modes. Normal continuous conduction mode (CCM) occurs when the minimum switch current is above 0 A. In CCM, the TPS562208 operates at a quasi-fixed frequency of 580 kHz.

7.4.2 Eco-mode Operation

When the TPS562201 and TPS562208 are in the normal CCM operating mode and the switch current falls to 0 A, the TPS562208 begins operating in pulse skipping Eco-mode. Each switching cycle is followed by a period of energy saving sleep time. The sleep time ends when the VFB voltage falls below the Eco-mode threshold voltage. As the output current decreases, the perceived time between switching pulses increases.

7.4.3 Standby Operation

When the TPS562201 and TPS562208 are operating in either normal CCM or Eco-mode, they can be placed in standby by asserting the EN pin low.

8 Application and Implementation

Note

Information in the following applications sections is not part of the TI component specification, and TI does not warrant its accuracy or completeness. TI's customers are responsible for determining suitability of components for their purposes. Customers should validate and test their design implementation to confirm system functionality.

8.1 Application Information

The devices are typical step-down DC-DC converters. It typically uses to convert a higher dc voltage to a lower dc voltage with a maximum available output current of 2 A. The following design procedure can be used to select component values for the TPS562201 and TPS562208. Alternately, the WEBENCH® software may be used to generate a complete design. The WEBENCH software uses an iterative design procedure and accesses a comprehensive database of components when generating a design. This section presents a simplified discussion of the design process.

8.2 Typical Application

The application schematic in Figure 8-1 was developed to meet the previous requirements. This circuit is available as the evaluation module (EVM). The sections provide the design procedure.

Figure 8-1 shows the TPS562201 and TPS562208 4.5-V to 17-V Input, 1.05-V output converter schematics.

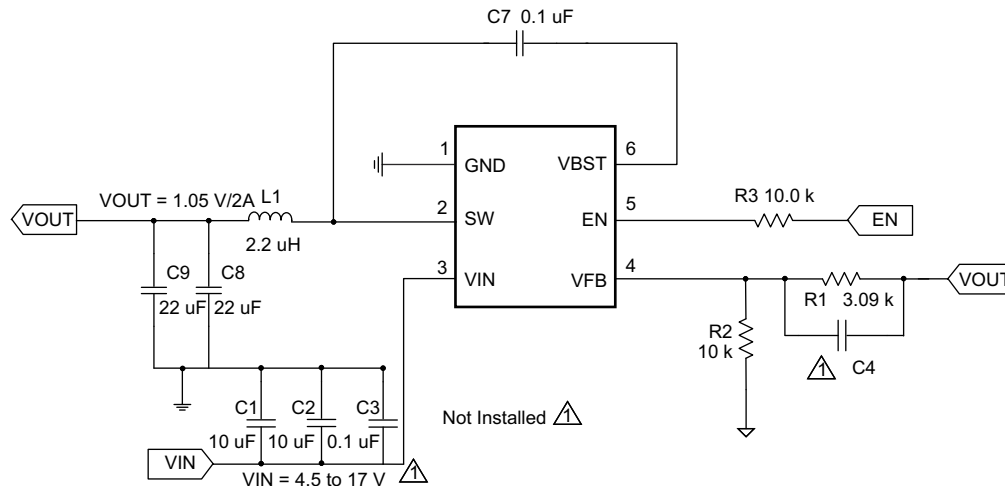

Figure 8-1. TPS562201 and TPS562208 1.05-V/2-A Reference Design

8.2.1 Design Requirements

Table 8-1 shows the design parameters.

Table 8-1. Design Parameters

| PARAMETER | EXAMPLE VALUE |
|-------------------------------------|----------------------------|
| Input voltage range | 4.5 to 17 V |
| Output voltage | 1.05 V |
| Transient response, 1.5-A load step | $\Delta V_{out} = \pm 5\%$ |
| Input ripple voltage | 400 mV |
| Output ripple voltage | 30 mV |
| Output current rating | 2A |
| Operating frequency | 580 kHz |

8.2.2 Detailed Design Procedure

8.2.2.1 Output Voltage Resistors Selection

The output voltage is set with a resistor divider from the output node to the VFB pin. TI recommends to use 1% tolerance or better divider resistors. Start by using [Equation 2](#) to calculate V_{OUT}.

To improve efficiency at very light loads, consider using larger value resistors. Too high of resistance will be more susceptible to noise and voltage errors from the VFB input current will be more noticeable.

$$V_{OUT} = 0.768 \times \left(1 + \frac{R1}{R2} \right) \quad (2)$$

8.2.2.2 Output Filter Selection

The LC filter used as the output filter has double pole at:

$$F_P = \frac{1}{2\pi\sqrt{L_{OUT} \times C_{OUT}}} \quad (3)$$

At low frequencies, the overall loop gain is set by the output set-point resistor divider network and the internal gain of the device. The low frequency phase is 180 degrees. At the output filter pole frequency, the gain rolls off at a –40 dB per decade rate and the phase drops rapidly. D-CAP2 introduces a high frequency zero that reduces the gain roll off to –20 dB per decade and increases the phase to 90 degrees one decade above the zero frequency. The inductor and capacitor for the output filter must be selected so that the double pole of Equation 3 is located below the high frequency zero but close enough that the phase boost provided by the high frequency zero provides adequate phase margin for a stable circuit. To meet this requirement use the values recommended in [Table 8-2](#).

Table 8-2. Recommended Component Values

| OUTPUT VOLTAGE (V) | R1 (kΩ) | R2 (kΩ) | L1 (μH) | | | C8 + C9 (μF) |
|-----------------------|------------|------------|---------|-----|-----|-----------------|
| | | | MIN | TYP | MAX | |
| 1 | 3.09 | 10.0 | 2.2 | 2.2 | 4.7 | 20 to 68 |
| 1.05 | 3.74 | 10.0 | 2.2 | 2.2 | 4.7 | 20 to 68 |
| 1.2 | 5.76 | 10.0 | 2.2 | 2.2 | 4.7 | 20 to 68 |
| 1.5 | 9.53 | 10.0 | 2.2 | 2.2 | 4.7 | 20 to 68 |
| 1.8 | 13.7 | 10.0 | 2.2 | 2.2 | 4.7 | 20 to 68 |
| 2.5 | 22.6 | 10.0 | 3.3 | 3.3 | 4.7 | 20 to 68 |
| 3.3 | 33.2 | 10.0 | 3.3 | 3.3 | 4.7 | 20 to 68 |
| 5 | 54.9 | 10.0 | 3.3 | 4.7 | 4.7 | 20 to 68 |
| 6.5 | 75 | 10.0 | 3.3 | 4.7 | 4.7 | 20 to 68 |

The inductor peak-to-peak ripple current, peak current, and RMS current are calculated using [Equation 4](#), [Equation 5](#), and [Equation 6](#). The inductor saturation current rating must be greater than the calculated peak current and the RMS or heating current rating must be greater than the calculated RMS current.

Use 580 kHz for f_{SW} . Make sure the chosen inductor is rated for the peak current of [Equation 5](#) and the RMS current of [Equation 6](#).

$$I_{P-P} = \frac{V_{OUT}}{V_{IN(MAX)}} \times \frac{V_{IN(MAX)} - V_{OUT}}{L_O \times f_{SW}} \quad (4)$$

$$I_{PEAK} = I_O + \frac{I_{P-P}}{2} \quad (5)$$

$$I_{LO(RMS)} = \sqrt{I_O^2 + \frac{1}{12} I_{P-P}^2} \quad (6)$$

For this design example, the calculated peak current is 3.5 A and the calculated RMS current is 3.01 A. The inductor used is a WE 744311330 with a peak current rating of 11 A and an RMS current rating of 6.5 A.

The capacitor value and ESR determines the amount of output voltage ripple. The TPS562201 and TPS562208 are intended for use with ceramic or other low-ESR capacitors. Recommended values range from 20 μ F to 68 μ F. Use Equation 7 to determine the required RMS current rating for the output capacitor.

$$I_{CO(RMS)} = \frac{V_{OUT} \times (V_{IN} - V_{OUT})}{\sqrt{12} \times V_{IN} \times L_O \times f_{SW}} \quad (7)$$

For this design, two TDK C3216X5R0J226M 22- μ F output capacitors are used. The typical ESR is 2 m Ω each. The calculated RMS current is 0.286 A and each output capacitor is rated for 4 A.

8.2.2.3 Input Capacitor Selection

The TPS562201 and TPS562208 require an input decoupling capacitor and a bulk capacitor is needed depending on the application. TI recommends a ceramic capacitor over 10 μ F for the decoupling capacitor. An additional 0.1- μ F capacitor (C3) from pin 3 to ground is optional to provide additional high frequency filtering. The capacitor voltage rating needs to be greater than the maximum input voltage.

8.2.2.4 Bootstrap Capacitor Selection

A 0.1- μ F ceramic capacitor must be connected between the VBST to SW pin for proper operation. TI recommends to use a ceramic capacitor.

8.2.3 Application Curves

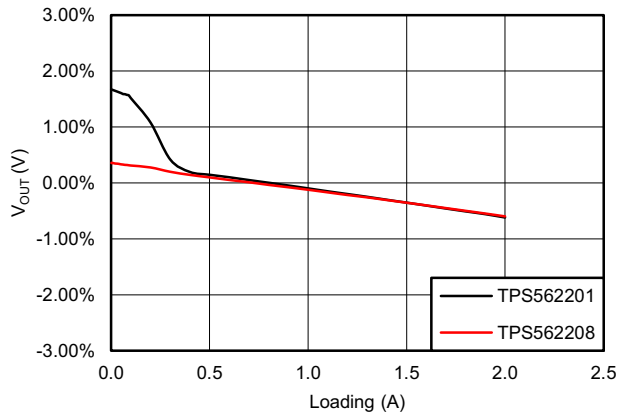

Figure 8-2. Load Regulation, $V_{IN} = 5\text{ V}$

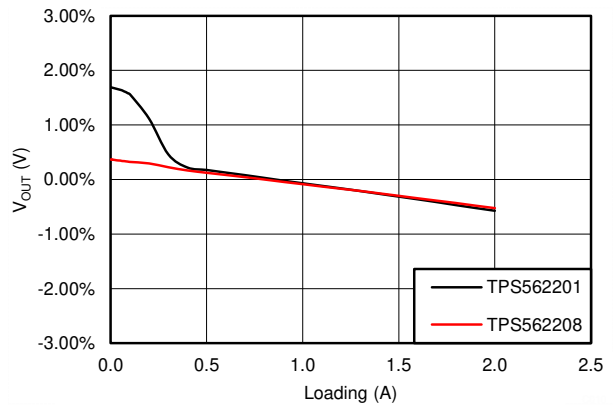
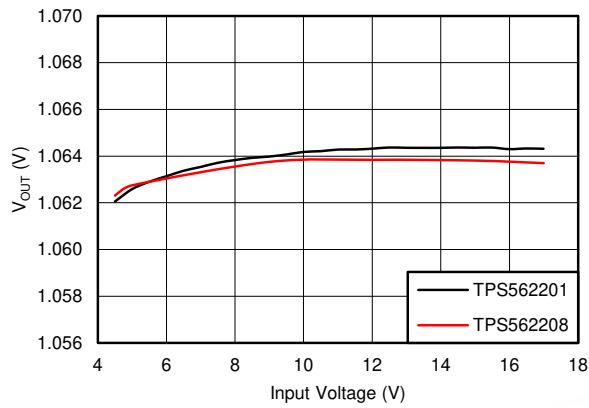

Figure 8-3. Load Regulation $V_{IN} = 12\text{ V}$



TPS562201: $I_{out} = 1\text{ A}$
 TPS562208: $I_{out} = 10\text{ mA}$

Figure 8-4. Line Regulation

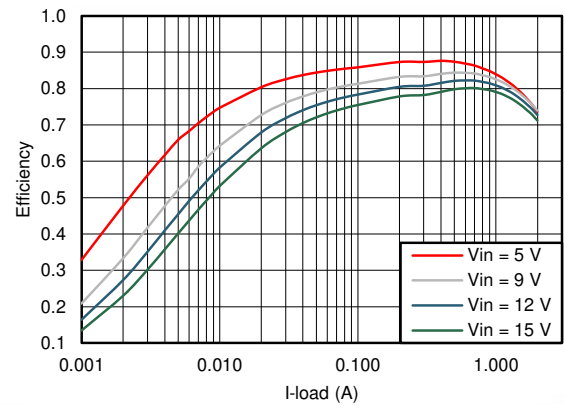

Figure 8-5. TPS562201 Efficiency, $V_{OUT} = 1.05\text{ V}$

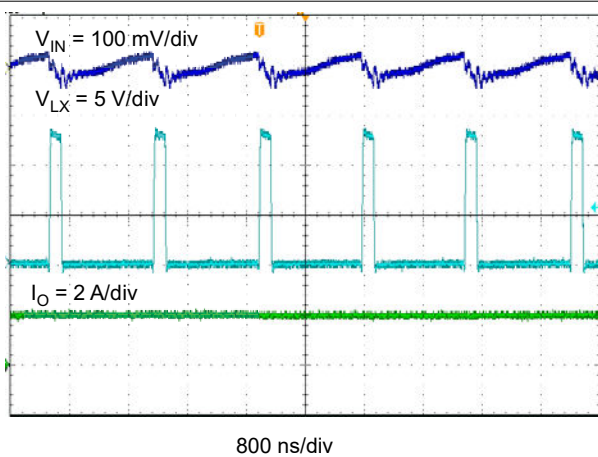

Figure 8-6. TPS562201 Input Voltage Ripple

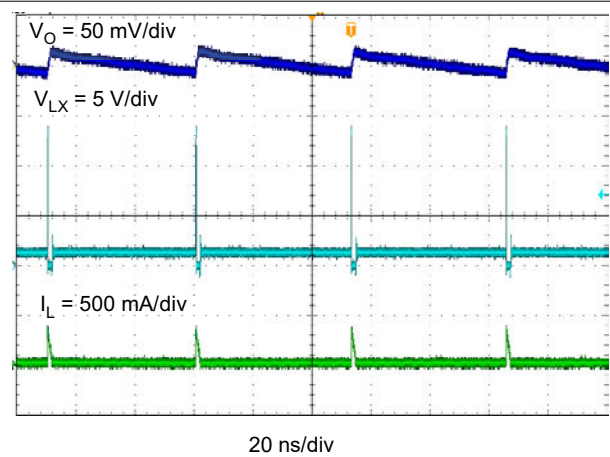

Figure 8-7. TPS562201 Output Voltage Ripple, $I_{OUT} = 10\text{ mA}$

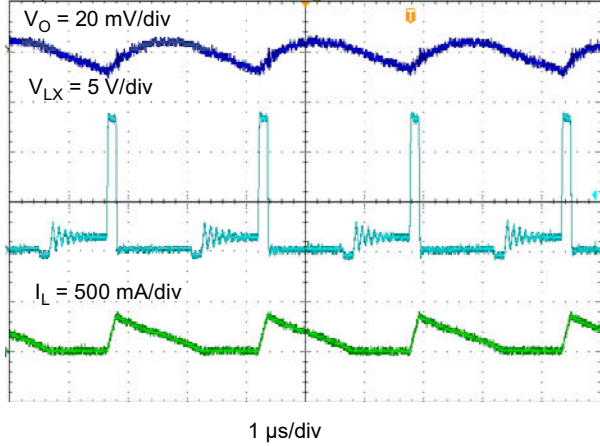

Figure 8-8. TPS562201 Output Voltage Ripple, $I_{OUT} = 0.25$ A

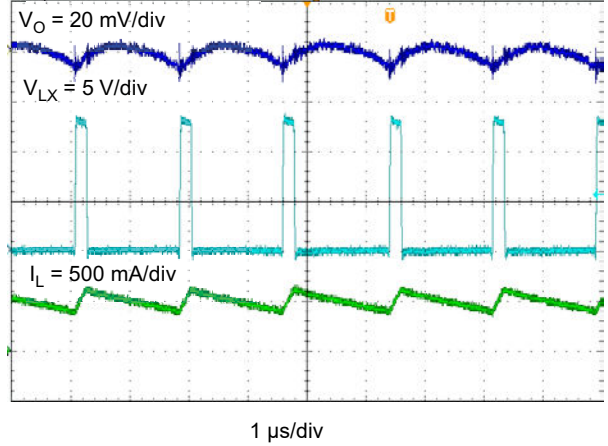

Figure 8-9. TPS562201 Output Voltage Ripple, $I_{OUT} = 2$ A

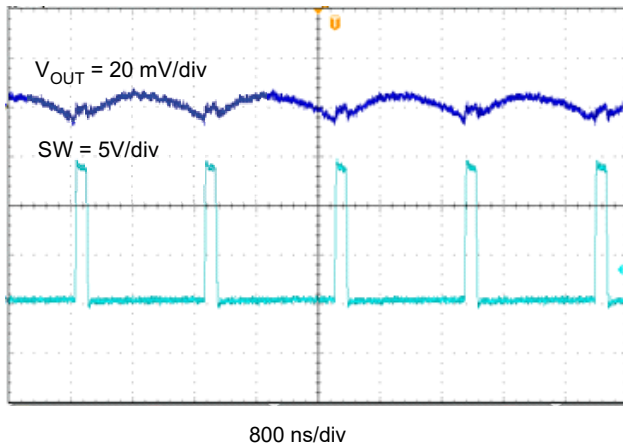

Figure 8-10. TPS562208 Output Voltage Ripple, $I_{OUT} = 0$ A

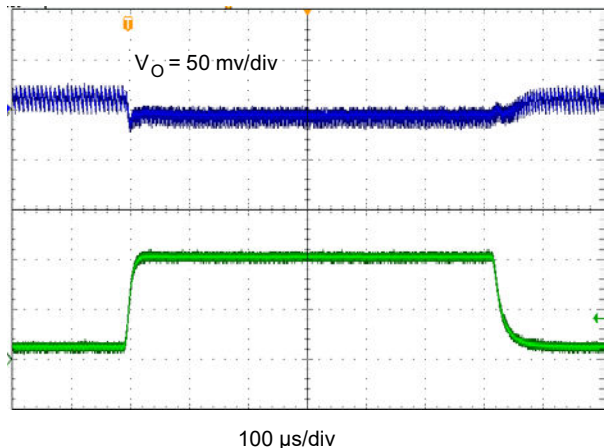

Figure 8-11. TPS562201 Transient Response, 0.1 to 1.5 A

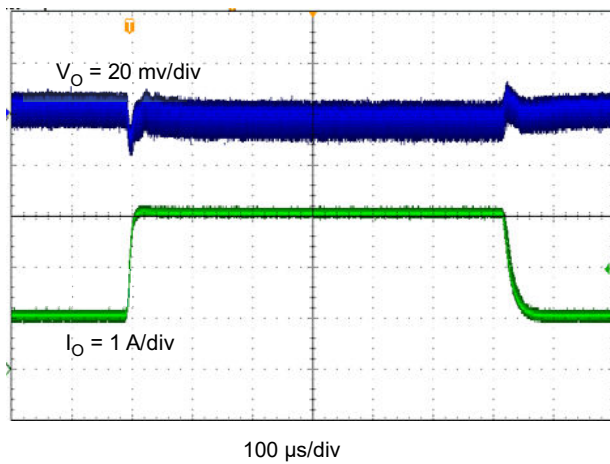

Figure 8-12. TPS562201 Transient Response, 0.75 to 2.25 A

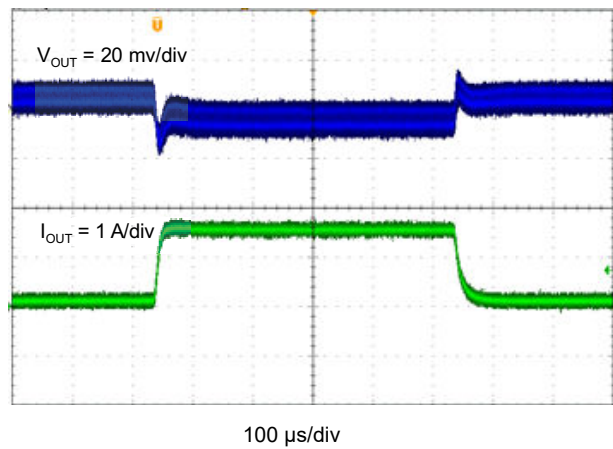

Figure 8-13. TPS562208 Transient Response 0.1 to 2 A

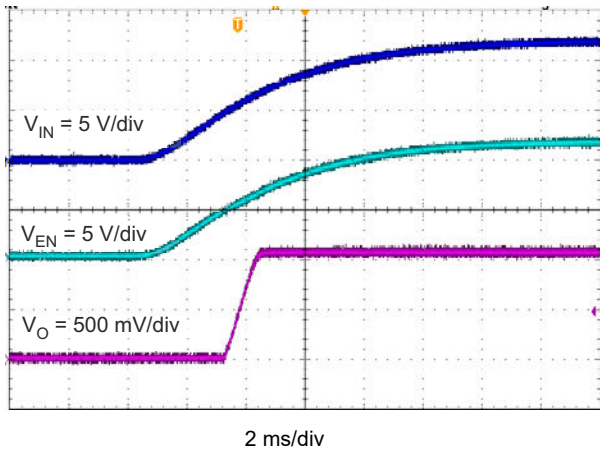

Figure 8-14. TPS562201 Start-Up Relative to V_I

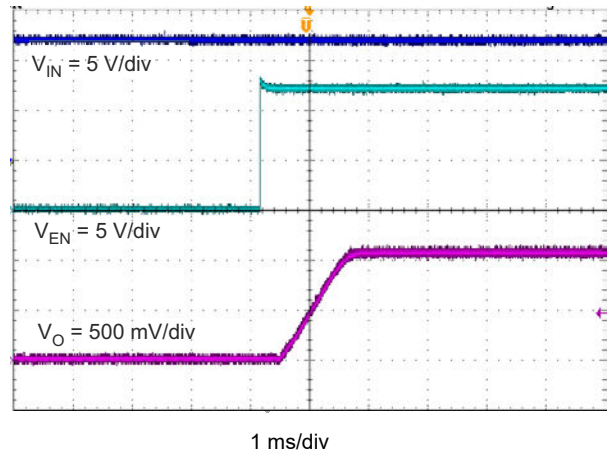

Figure 8-15. TPS562201 Start-Up Relative to EN

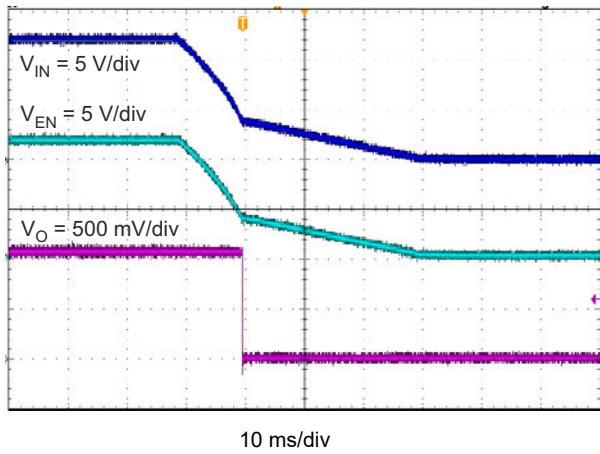

Figure 8-16. TPS562201 Shutdown Relative to V_I

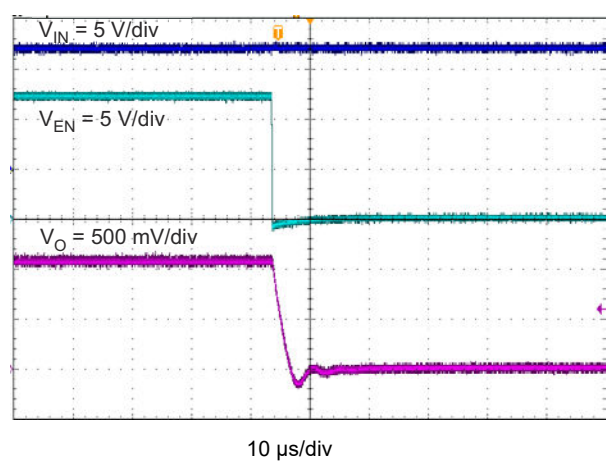

Figure 8-17. TPS562201 Shutdown Relative to EN

9 Power Supply Recommendations

The TPS562201 and TPS562208 are designed to operate from input supply voltage in the range of 4.5 V to 17 V. Buck converters require the input voltage to be higher than the output voltage for proper operation. The maximum recommended operating duty cycle is 75%. Using that criteria, the minimum recommended input voltage is $V_O / 0.75$.

10 Layout

10.1 Layout Guidelines

1. VIN and GND traces should be as wide as possible to reduce trace impedance. The wide areas are also of advantage from the view point of heat dissipation.
2. The input capacitor and output capacitor should be placed as close to the device as possible to minimize trace impedance.
3. Provide sufficient vias for the input capacitor and output capacitor.
4. Keep the SW trace as physically short and wide as practical to minimize radiated emissions.
5. Do not allow switching current to flow under the device.
6. A separate VOUT path should be connected to the upper feedback resistor.
7. Make a Kelvin connection to the GND pin for the feedback path.
8. Voltage feedback loop should be placed away from the high-voltage switching trace, and preferably has ground shield.
9. The trace of the VFB node should be as small as possible to avoid noise coupling.
10. The GND trace between the output capacitor and the GND pin should be as wide as possible to minimize its trace impedance.

10.2 Layout Example

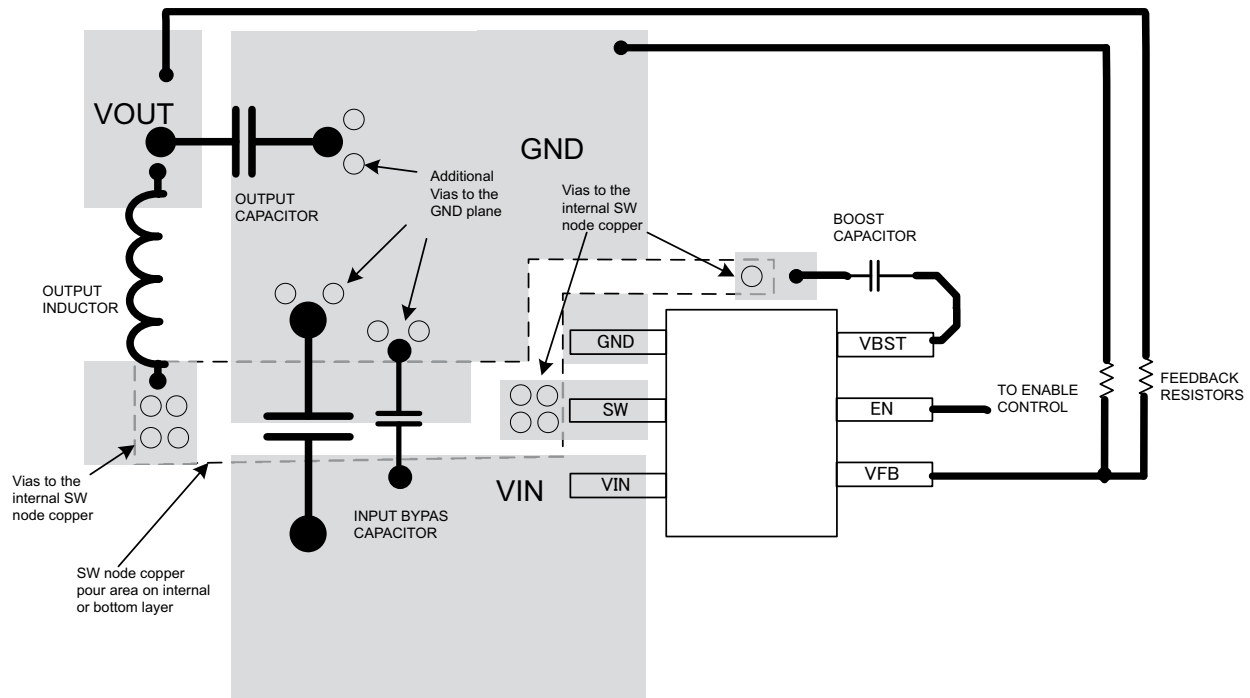

Figure 10-1. TPS562201 and TPS562208 Layout

11 Device and Documentation Support

11.1 Receiving Notification of Documentation Updates

To receive notification of documentation updates, navigate to the device product folder on ti.com. Click on *Subscribe to updates* to register and receive a weekly digest of any product information that has changed. For change details, review the revision history included in any revised document.

11.2 Support Resources

[TI E2E™ support forums](#) are an engineer's go-to source for fast, verified answers and design help — straight from the experts. Search existing answers or ask your own question to get the quick design help you need.

Linked content is provided "AS IS" by the respective contributors. They do not constitute TI specifications and do not necessarily reflect TI's views; see TI's [Terms of Use](#).

11.3 Trademarks

D-CAP2™, Eco-mode™, and TI E2E™ are trademarks of Texas Instruments.

Blu-ray™ is a trademark of Blu-ray Disc Association.

WEBENCH® is a registered trademark of Texas Instruments.

All other trademarks are the property of their respective owners.

11.4 Electrostatic Discharge Caution



This integrated circuit can be damaged by ESD. Texas Instruments recommends that all integrated circuits be handled with appropriate precautions. Failure to observe proper handling and installation procedures can cause damage.

ESD damage can range from subtle performance degradation to complete device failure. Precision integrated circuits may be more susceptible to damage because very small parametric changes could cause the device not to meet its published specifications.

11.5 Glossary

[TI Glossary](#) This glossary lists and explains terms, acronyms, and definitions.

12 Mechanical, Packaging, and Orderable Information

The following pages include mechanical, packaging, and orderable information. This information is the most current data available for the designated devices. This data is subject to change without notice and revision of this document. For browser-based versions of this data sheet, refer to the left-hand navigation.

PACKAGING INFORMATION

| Orderable Device | Status (1) | Package Type | Package Drawing | Pins | Package Qty | Eco Plan (2) | Lead finish/ Ball material (6) | MSL Peak Temp (3) | Op Temp (°C) | Device Marking (4/5) | Samples |
|------------------|---------------|--------------|-----------------|------|-------------|-----------------|--------------------------------------|----------------------|--------------|-------------------------|-------------------------|
| TPS562201DDCR | ACTIVE | SOT-23-THIN | DDC | 6 | 3000 | RoHS & Green | Call TI SN | Level-1-260C-UNLIM | -40 to 125 | 2201 | Samples |
| TPS562201DDCT | ACTIVE | SOT-23-THIN | DDC | 6 | 250 | RoHS & Green | Call TI SN | Level-1-260C-UNLIM | -40 to 125 | 2201 | Samples |
| TPS562208DDCR | ACTIVE | SOT-23-THIN | DDC | 6 | 3000 | RoHS & Green | Call TI SN | Level-1-260C-UNLIM | -40 to 125 | 2208 | Samples |
| TPS562208DDCT | ACTIVE | SOT-23-THIN | DDC | 6 | 250 | RoHS & Green | Call TI SN | Level-1-260C-UNLIM | -40 to 125 | 2208 | Samples |

(1) The marketing status values are defined as follows:

ACTIVE: Product device recommended for new designs.

LIFEBUY: TI has announced that the device will be discontinued, and a lifetime-buy period is in effect.

NRND: Not recommended for new designs. Device is in production to support existing customers, but TI does not recommend using this part in a new design.

PREVIEW: Device has been announced but is not in production. Samples may or may not be available.

OBSELETE: TI has discontinued the production of the device.

(2) **RoHS:** TI defines "RoHS" to mean semiconductor products that are compliant with the current EU RoHS requirements for all 10 RoHS substances, including the requirement that RoHS substance do not exceed 0.1% by weight in homogeneous materials. Where designed to be soldered at high temperatures, "RoHS" products are suitable for use in specified lead-free processes. TI may reference these types of products as "Pb-Free".

RoHS Exempt: TI defines "RoHS Exempt" to mean products that contain lead but are compliant with EU RoHS pursuant to a specific EU RoHS exemption.

Green: TI defines "Green" to mean the content of Chlorine (Cl) and Bromine (Br) based flame retardants meet JS709B low halogen requirements of <=1000ppm threshold. Antimony trioxide based flame retardants must also meet the <=1000ppm threshold requirement.

(3) MSL, Peak Temp. - The Moisture Sensitivity Level rating according to the JEDEC industry standard classifications, and peak solder temperature.

(4) There may be additional marking, which relates to the logo, the lot trace code information, or the environmental category on the device.

(5) Multiple Device Markings will be inside parentheses. Only one Device Marking contained in parentheses and separated by a "-" will appear on a device. If a line is indented then it is a continuation of the previous line and the two combined represent the entire Device Marking for that device.

(6) Lead finish/Ball material - Orderable Devices may have multiple material finish options. Finish options are separated by a vertical ruled line. Lead finish/Ball material values may wrap to two lines if the finish value exceeds the maximum column width.

Important Information and Disclaimer:The information provided on this page represents TI's knowledge and belief as of the date that it is provided. TI bases its knowledge and belief on information provided by third parties, and makes no representation or warranty as to the accuracy of such information. Efforts are underway to better integrate information from third parties. TI has taken and

TAPE AND REEL INFORMATION

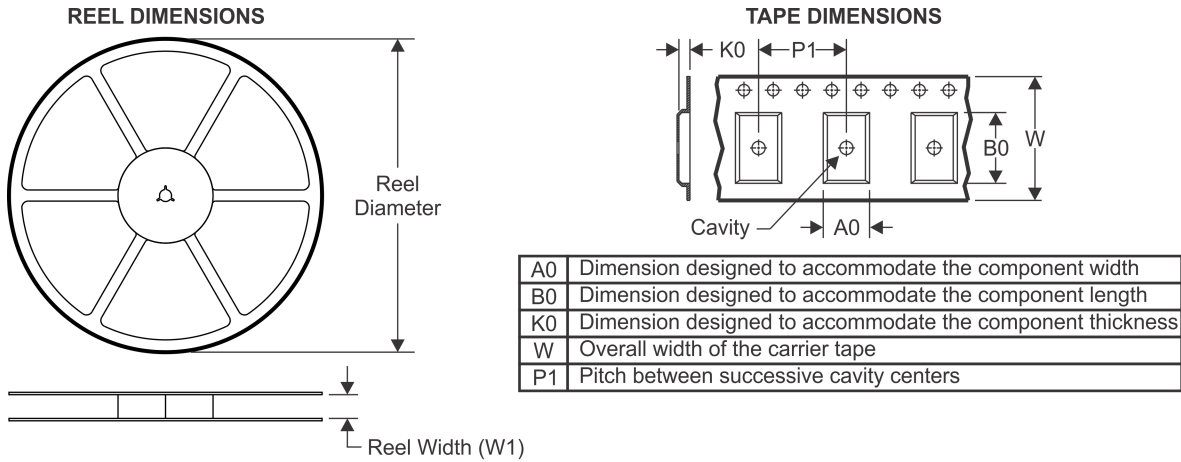

QUADRANT ASSIGNMENTS FOR PIN 1 ORIENTATION IN TAPE

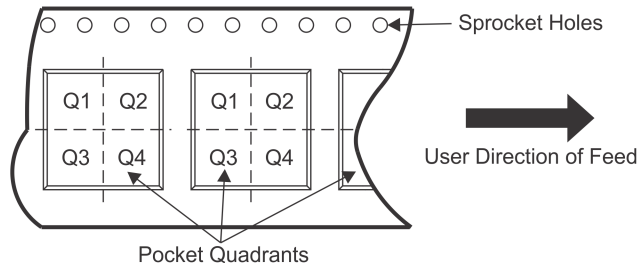

*All dimensions are nominal

| Device | Package Type | Package Drawing | Pins | SPQ | Reel Diameter (mm) | Reel Width W1 (mm) | A0 (mm) | B0 (mm) | K0 (mm) | P1 (mm) | W (mm) | Pin1 Quadrant |
|---------------|--------------|-----------------|------|------|--------------------|--------------------|---------|---------|---------|---------|--------|---------------|
| TPS562201DDCR | SOT-23-THIN | DDC | 6 | 3000 | 180.0 | 8.4 | 3.2 | 3.2 | 1.4 | 4.0 | 8.0 | Q3 |
| TPS562201DDCT | SOT-23-THIN | DDC | 6 | 250 | 180.0 | 8.4 | 3.2 | 3.2 | 1.4 | 4.0 | 8.0 | Q3 |
| TPS562208DDCR | SOT-23-THIN | DDC | 6 | 3000 | 180.0 | 8.4 | 3.2 | 3.2 | 1.4 | 4.0 | 8.0 | Q3 |
| TPS562208DDCT | SOT-23-THIN | DDC | 6 | 250 | 180.0 | 8.4 | 3.2 | 3.2 | 1.4 | 4.0 | 8.0 | Q3 |

PACKAGE MATERIALS INFORMATION

29-Jan-2022

TAPE AND REEL BOX DIMENSIONS

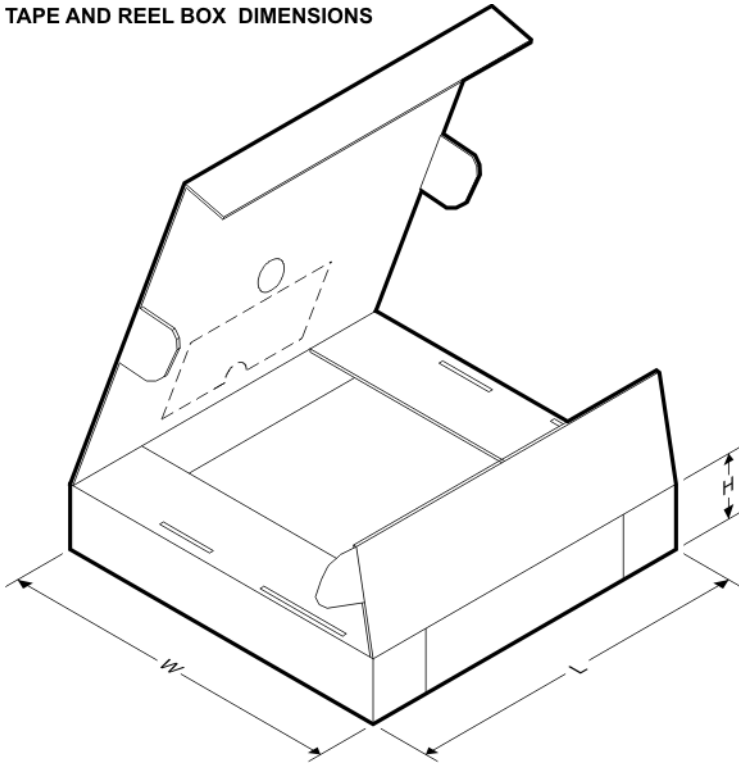

*All dimensions are nominal

| Device | Package Type | Package Drawing | Pins | SPQ | Length (mm) | Width (mm) | Height (mm) |
|---------------|--------------|-----------------|------|------|-------------|------------|-------------|
| TPS562201DDCR | SOT-23-THIN | DDC | 6 | 3000 | 210.0 | 185.0 | 35.0 |
| TPS562201DDCT | SOT-23-THIN | DDC | 6 | 250 | 210.0 | 185.0 | 35.0 |
| TPS562208DDCR | SOT-23-THIN | DDC | 6 | 3000 | 210.0 | 185.0 | 35.0 |
| TPS562208DDCT | SOT-23-THIN | DDC | 6 | 250 | 210.0 | 185.0 | 35.0 |

EXAMPLE BOARD LAYOUT

DDC0006A

SOT-23 - 1.1 max height

SMALL OUTLINE TRANSISTOR

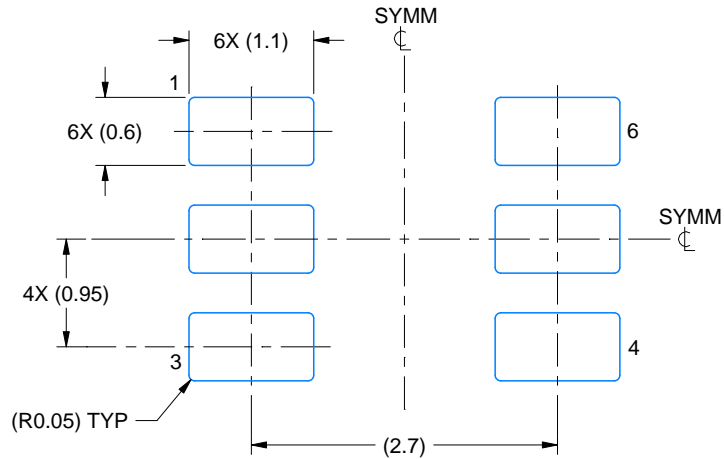

LAND PATTERN EXAMPLE
EXPLODED METAL SHOWN
SCALE:15X

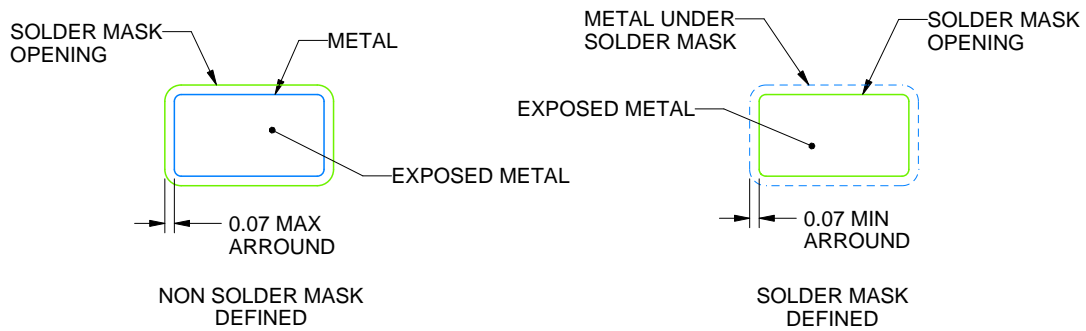

SOLDERMASK DETAILS

4214841/C 04/2022

NOTES: (continued)

- 4. Publication IPC-7351 may have alternate designs.
- 5. Solder mask tolerances between and around signal pads can vary based on board fabrication site.

EXAMPLE STENCIL DESIGN

DDC0006A

SOT-23 - 1.1 max height

SMALL OUTLINE TRANSISTOR

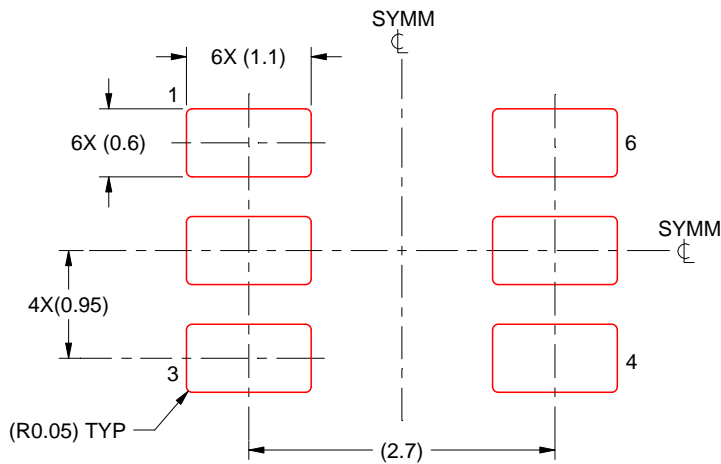

SOLDER PASTE EXAMPLE
BASED ON 0.125 THICK STENCIL
SCALE:15X

4214841/C 04/2022

NOTES: (continued)

6. Laser cutting apertures with trapezoidal walls and rounded corners may offer better paste release. IPC-7525 may have alternate design recommendations.
7. Board assembly site may have different recommendations for stencil design.