

### GENERAL DESCRIPTION

The SGM72004A is a single-pole/four-throw (SP4T) antenna switch, which supports from 0.1GHz to 3GHz. The device features low insertion loss and high isolation, which makes it suitable for high linearity receiving application. It also has the advantage of high linearity performance. The SGM72004A is not subject to cellular interference and is applied to multi-mode and multi-band LTE mobile phones.

The SGM72004A has the ability to integrate SP4T RF switch and GPIO controller on an SOI chip. Internal driver and decoder for switch control signals are offered by the GPIO controller, which makes it flexible in RF path band and routing selection.

No external DC blocking capacitors required on the RF paths as long as no external DC voltage is applied, which can save PCB area and cost.

The SGM72004A is available in a Green ULGA-1.1×1.1-9L package.

### APPLICATIONS

2G/3G/4G Receiving

### FEATURES

- **Supply Voltage Range: 2.4V to 3V**
- **GPIO Controller**
- **Operating Frequency Range: 0.1GHz to 3GHz**
- **Advanced Silicon-On-Insulator (SOI) Process**
- **Low Insertion Loss: 0.4dB (TYP) at 2.7GHz**
- **High Isolation: 18dB (MIN) at 2.7GHz**
- **No External DC Blocking Capacitors Required**
- **Available in a Green ULGA-1.1×1.1-9L Package**

### BLOCK DIAGRAM

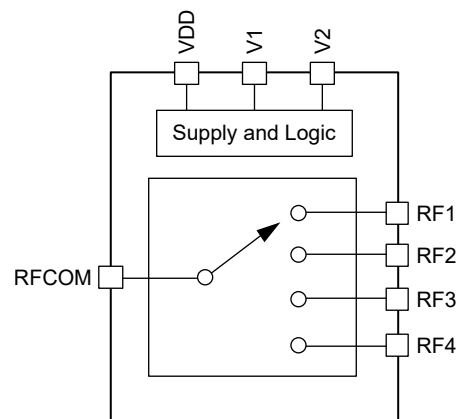

Figure 1. SGM72004A Block Diagram

**PACKAGE/ORDERING INFORMATION**

MODEL	PACKAGE DESCRIPTION	SPECIFIED TEMPERATURE RANGE	ORDERING NUMBER	PACKAGE MARKING	PACKING OPTION
SGM72004A	ULGA-1.1×1.1-9L	-40°C to +85°C	SGM72004AYULA9G/TR	PD	Tape and Reel, 3000

**MARKING INFORMATION**

NOTE: Fixed character for PD.



Green (RoHS & HSF): SG Micro Corp defines "Green" to mean Pb-Free (RoHS compatible) and free of halogen substances. If you have additional comments or questions, please contact your SGMICRO representative directly.

**ABSOLUTE MAXIMUM RATINGS**

- Supply Voltage,  $V_{DD}$ ..... 3.3V
- Control Voltage (V1 and V2 Pins),  $V_{CTL}$  ..... 3V
- RF Input Power,  $P_{IN}$  ..... 27dBm
- Junction Temperature ..... +150°C
- Storage Temperature Range ..... -55°C to +150°C
- Lead Temperature (Soldering, 10s) ..... +260°C
- ESD Susceptibility
- HBM..... 1000V

**RECOMMENDED OPERATING CONDITIONS**

- Operating Temperature Range ..... -40°C to +85°C
- Operating Frequency Range..... 0.1GHz to 3GHz
- Supply Voltage,  $V_{DD}$ ..... 2.4V to 3V
- Control High Voltage,  $V_{CTL\_H}$ ..... 1.35V to 3V
- Control Low Voltage,  $V_{CTL\_L}$  ..... 0V to 0.4V

**OVERSTRESS CAUTION**

Stresses beyond those listed in Absolute Maximum Ratings may cause permanent damage to the device. Exposure to absolute maximum rating conditions for extended periods may affect reliability. Functional operation of the device at any conditions beyond those indicated in the Recommended Operating Conditions section is not implied.

**ESD SENSITIVITY CAUTION**

This integrated circuit can be damaged if ESD protections are not considered carefully. SGMICRO recommends that all integrated circuits be handled with appropriate precautions. Failure to observe proper handling and installation procedures can cause damage. ESD damage can range from subtle performance degradation to complete device failure. Precision integrated circuits may be more susceptible to damage because even small parametric changes could cause the device not to meet the published specifications.

**DISCLAIMER**

SG Micro Corp reserves the right to make any change in circuit design, or specifications without prior notice.

## PIN CONFIGURATION

(TOP VIEW)

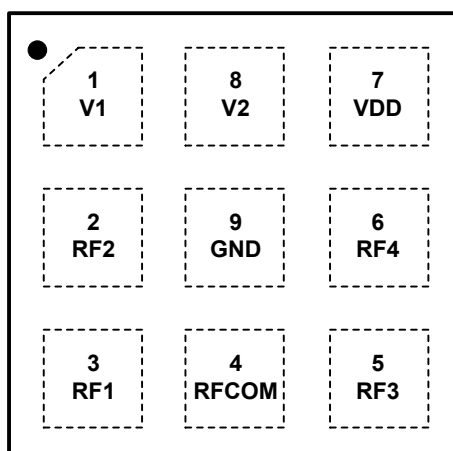

ULGA-1.1x1.1-9L

## PIN DESCRIPTION

PIN	NAME	FUNCTION
1	V1	DC Control Voltage 1.
2	RF2	RF Port 2.
3	RF1	RF Port 1.
4	RFCOM	RF Common Port.
5	RF3	RF Port 3.
6	RF4	RF Port 4.
7	VDD	DC Power Supply.
8	V2	DC Control Voltage 2.
9	GND	Ground.

## LOGIC TRUTH TABLE

VDD	V1	V2	ACTIVE PATH
H	L	H	RFCOM to RF1
H	H	L	RFCOM to RF2
H	H	H	RFCOM to RF3
H	L	L	RFCOM to RF4

**ELECTRICAL CHARACTERISTICS**(V<sub>DD</sub> = 2.4V to 3V, T<sub>A</sub> = +25°C, P<sub>IN</sub> = 0dBm, 50Ω, typical values are at V<sub>DD</sub> = 2.8V, unless otherwise noted.)

PARAMETER	SYMBOL	CONDITIONS	MIN	TYP	MAX	UNITS
<b>DC Specifications</b>						
Supply Voltage	V <sub>DD</sub>		2.4	2.8	3	V
Supply Current	I <sub>DD</sub>			32	65	μA
Control Voltage	V <sub>CTL_H</sub>	High	1.35	1.8	3	V
	V <sub>CTL_L</sub>	Low	0		0.4	
Control Current	I <sub>CTL</sub>	V <sub>CTL</sub> = 0V		3	7	μA
Switching Time	t <sub>SW</sub>	50% of control voltage to 90% of RF power		1	2	μs
Turn-On Time	t <sub>ON</sub>	Time from V <sub>DD</sub> = 0V to part on and RF at 90%		5	10	μs
<b>RF Specifications</b>						
Insertion Loss (RFCOM to All RF Ports)	IL	0.1GHz to 1.0GHz		0.20	0.41	dB
		1.0GHz to 2.0GHz		0.30	0.65	
		2.0GHz to 2.7GHz		0.40	1.01	
Isolation (RFCOM to All RF Ports)	ISO	0.1GHz to 1.0GHz	29	35		dB
		1.0GHz to 2.0GHz	19	30		
		2.0GHz to 2.7GHz	18	25		
Input Return Loss (RFCOM to All RF Ports)	RL	0.1GHz to 1.0GHz		25		dB
		1.0GHz to 2.0GHz		24		
		2.0GHz to 2.7GHz		23		
0.1dB Compression Point (RFCOM to All RF Ports)	P <sub>0.1dB</sub>	0.1GHz to 3GHz		27		dBm

TYPICAL APPLICATION CIRCUIT

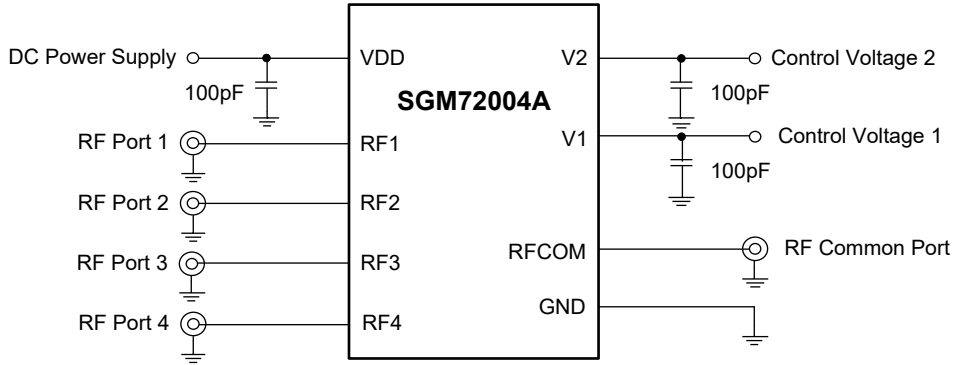

Figure 2. SGM72004A Typical Application Circuit

EVALUATION BOARD LAYOUT

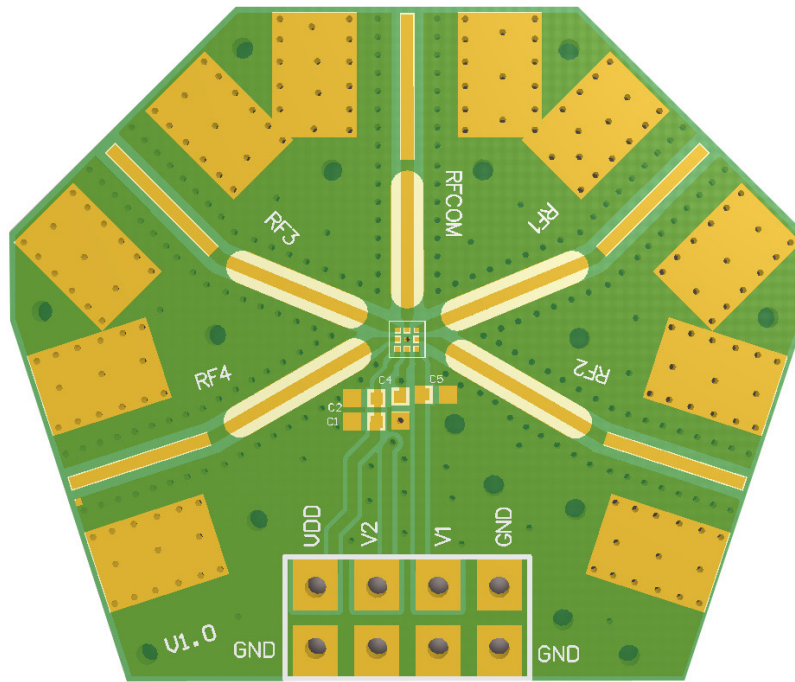

Figure 3. SGM72004A Evaluation Board Layout

REVISION HISTORY

NOTE: Page numbers for previous revisions may differ from page numbers in the current version.

Changes from Original (MARCH 2022) to REV.A	Page
Changed from product preview to production data.....	All

PACKAGE OUTLINE DIMENSIONS

ULGA-1.1x1.1-9L

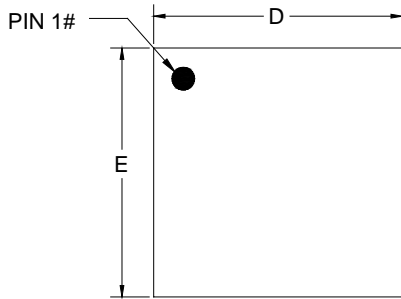

TOP VIEW

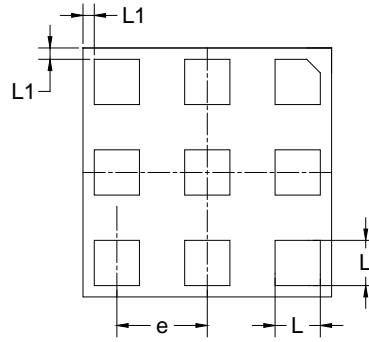

BOTTOM VIEW

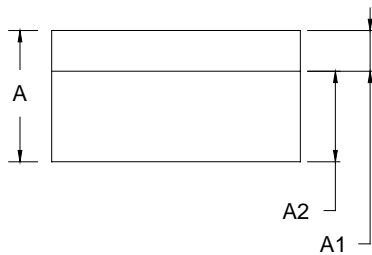

SIDE VIEW

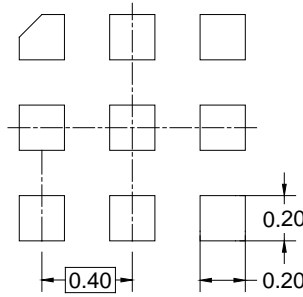

RECOMMENDED LAND PATTERN (Unit: mm)

Symbol	Dimensions In Millimeters		
	MIN	MOD	MAX
A	0.530	0.580	0.630
A1	0.150	0.180	0.210
A2	0.400 BSC		
D	1.000	1.100	1.200
E	1.000	1.100	1.200
e	0.400 BSC		
L	0.150	0.200	0.250
L1	0.050 REF		

NOTE: This drawing is subject to change without notice.

# PACKAGE INFORMATION

## TAPE AND REEL INFORMATION

### REEL DIMENSIONS



### TAPE DIMENSIONS



NOTE: The picture is only for reference. Please make the object as the standard.

### KEY PARAMETER LIST OF TAPE AND REEL

Package Type	Reel Diameter	Reel Width W1 (mm)	A0 (mm)	B0 (mm)	K0 (mm)	P0 (mm)	P1 (mm)	P2 (mm)	W (mm)	Pin1 Quadrant
ULGA-1.1×1.1-9L	7"	8.6	1.26	1.26	0.72	4.0	4.0	2.0	8.0	Q2

000001

# PACKAGE INFORMATION

## CARTON BOX DIMENSIONS



NOTE: The picture is only for reference. Please make the object as the standard.

## KEY PARAMETER LIST OF CARTON BOX

Reel Type	Length (mm)	Width (mm)	Height (mm)	Pizza/Carton
7" (Option)	368	227	224	8
7"	442	410	224	18

DD0002