

FR9883

18V, 2A, 500KHz Synchronous Step-Down DC/DC Converter

Description

The FR9883 is a synchronous step-down DC/DC converter that provides wide 4.5V to 18V input voltage range and 2A load current capability. At light load condition, the FR9883 can operate at power saving mode to support high efficiency and reduce power loss.

The FR9883 fault protection includes cycle-by-cycle current limit, short circuit protection, UVLO and thermal shutdown. The soft-start function prevents inrush current at turn-on. This device uses current mode control scheme which provides fast transient response. Internal compensation function reduces external compensation components and simplifies the design process. In shutdown mode, the supply current is about 1 μ A.

The FR9883 is offered in SOT-23-6 package, which provides a very compact system solution.

Pin Assignments

S6 Package (SOT-23-6)

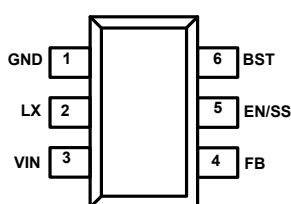

Figure 1. Pin Assignment of FR9883

Features

- Low $R_{DS(ON)}$ Integrated Power MOSFET (145m Ω /90m Ω)
- Internal Compensation Function
- Wide Input Voltage Range: 4.5V to 18V
- 0.8V Reference Voltage
- 2A Output Current
- 500kHz Switching Frequency
- Soft-Start Time Depends on EN/SS Resistor Adjustment
- Input Under Voltage Lockout
- Cycle-by-Cycle Current Limit
- Hiccup Short Circuit Protection
- Over-Temperature Protection with Auto Recovery
- SOT-23-6 Package

Applications

- STB (Set-Top-Box)
- LCD Display, TV
- Distributed Power System
- Networking, XDSL Modem

Ordering Information

FR9883 Package Type
S6: SOT-23-6

SOT-23-6 Marking

Part Number	Product Code
FR9883S6	FN7

Typical Application Circuit

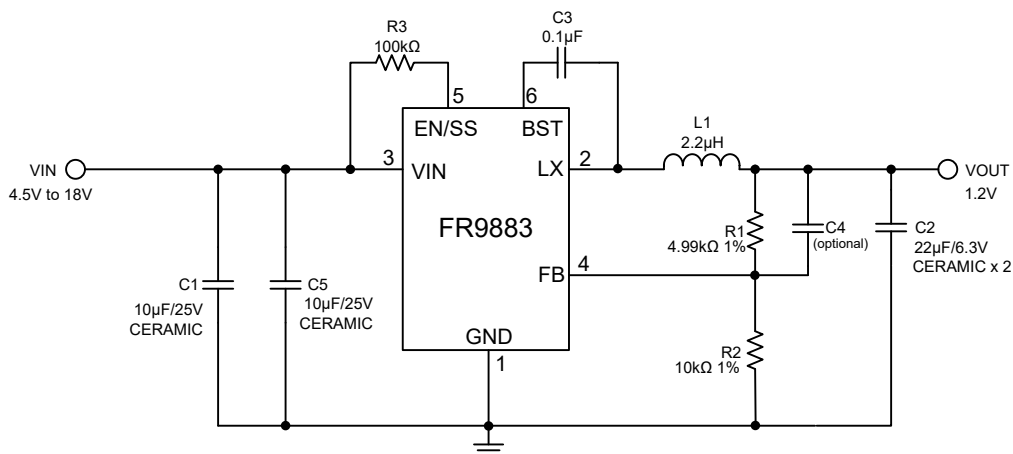

Figure 2. C_{IN}/C_{OUT} use Ceramic Capacitors Application Circuit

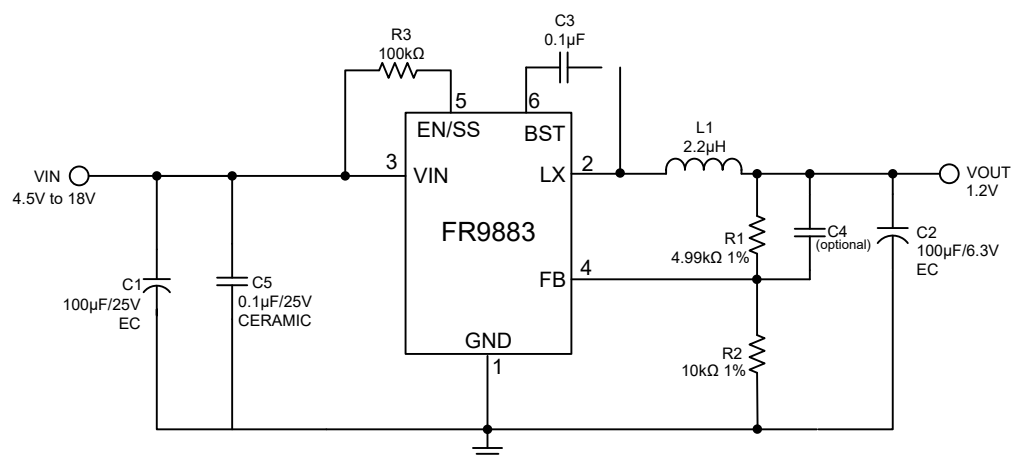

Figure 3. C_{IN}/C_{OUT} use Electrolytic Capacitors Application Circuit

$V_{IN}=12V$, the recommended BOM list is as below.

V_{OUT}	C1	R1	R2	C5	C4	L1	C2
1.2V	10μF MLCC	4.99kΩ	10kΩ	10μF MLCC	10pF~10nF	2.2uH	22μF MLCC x2
1.8V	10μF MLCC	4.99kΩ	3.92kΩ	10μF MLCC	10pF~10nF	3.3uH	22μF MLCC x2
2.5V	10μF MLCC	4.99kΩ	2.32kΩ	10μF MLCC	10pF~10nF	4.7uH	22μF MLCC x2
3.3V	10μF MLCC	30.9kΩ	9.76kΩ	10μF MLCC	10pF~10nF	4.7uH	22μF MLCC x2
5V	10μF MLCC	30.9kΩ	5.76kΩ	10μF MLCC	10pF~10nF	6.8uH	22μF MLCC x2
1.2V	100μF EC	4.99kΩ	10kΩ	0.1μF	--	2.2uH	100μF EC
1.8V	100μF EC	4.99kΩ	3.92kΩ	0.1μF	--	3.3uH	100μF EC
2.5V	100μF EC	4.99kΩ	2.32kΩ	0.1μF	--	4.7uH	100μF EC
3.3V	100μF EC	30.9kΩ	9.76kΩ	0.1μF	--	4.7uH	100μF EC
5V	100μF EC	30.9kΩ	5.76kΩ	0.1μF	--	6.8uH	100μF EC

Table 1. Recommended Component Values

Functional Pin Description

Pin Name	Pin No.	Pin Function
GND	1	Ground pin.
LX	2	Power switching node. Connect an external inductor to this switching node.
VIN	3	Power supply input pin. Placed input capacitors as close as possible from VIN to GND to avoid noise influence.
FB	4	Voltage feedback input pin. Connect FB and VOUT with a resistive voltage divider. This IC senses feedback voltage via FB and regulates it at 0.8V.
EN/SS	5	This pin includes enable the converter on/off, and soft-start time depends on an external resistor adjustment. Connect to VIN with a 100kΩ resistor for self-startup and 1ms soft start.
BST	6	High side gate drive boost pin. A capacitance between 10nF to 1μF must be connected from this pin to LX. It can boost the gate drive to fully turn on the internal high side NMOS.

Block Diagram

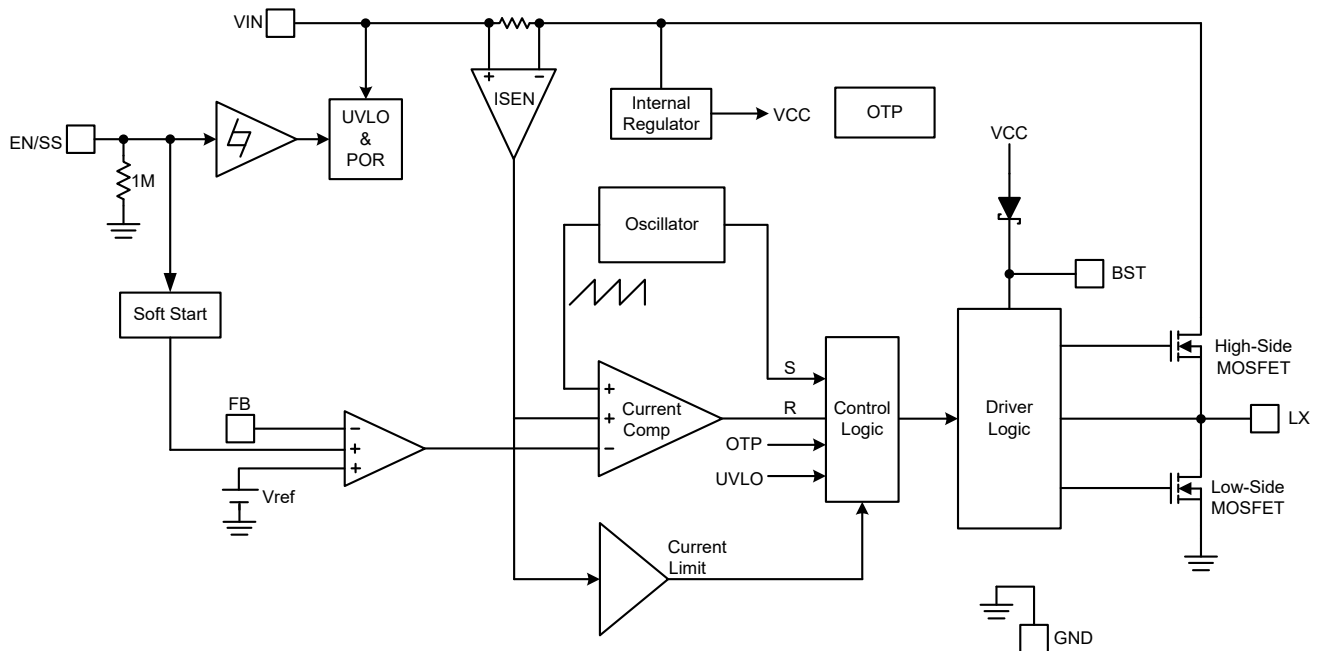

Figure 4. Block Diagram of FR9883

Absolute Maximum Ratings (Note 1)

- Supply Voltage V_{IN} ----- -0.3V to +20V
- LX Voltage V_{LX} ----- -1V to $V_{IN}+0.3V$
- Dynamic LX Voltage in 15ns Duration----- -5V to $V_{IN}+5V$
- BST Pin Voltage V_{BST} ----- $V_{LX}-0.3V$ to $V_{LX}+7.5V$
- All Other Pins Voltage ----- -0.3V to +20V
- Maximum Junction Temperature (T_J) ----- +150°C
- Storage Temperature (T_S) ----- -65°C to +150°C
- Lead Temperature (Soldering, 10sec.) ----- +260°C
- Package Thermal Resistance (θ_{JA}) (Note 2)
 SOT-23-6 ----- 250°C/W
- Package Thermal Resistance (θ_{JC})
 SOT-23-6 ----- 110°C/W

Note 1 : Stresses beyond this listed under "Absolute Maximum Ratings" may cause permanent damage to the device.

Note 2 : θ_{JA} is measured at 25°C ambient with the component mounted on a high effective thermal conductivity 4-layer board of JEDEC-51-7. The thermal resistance greatly varies with layout, copper thickness, number of layers and PCB size.

Recommended Operating Conditions

- Supply Voltage V_{IN} ----- +4.5V to +18V
- Operation Temperature Range ----- -40°C to +85°C

Electrical Characteristics

($V_{IN}=12V$, $T_A=25^{\circ}C$, unless otherwise specified.)

Parameter	Symbol	Conditions	Min	Typ	Max	Unit
V_{IN} Quiescent Current	I_{DDQ}	$V_{EN/SS}=2V$, $V_{FB}=1.0V$		1	1.2	mA
V_{IN} Shutdown Supply Current	I_{SD}	$V_{EN/SS}=0V$		1	3	μA
Feedback Voltage	V_{FB}	$4.5V \leq V_{IN} \leq 18V$	0.78	0.8	0.82	V
High-Side MOSFET $R_{DS(ON)}$ (Note 3)	$R_{DS(ON)}$			145		m Ω
Low-Side MOSFET $R_{DS(ON)}$ (Note 3)	$R_{DS(ON)}$			90		m Ω
High-Side MOSFET Leakage Current	$I_{LX(leak)}$	$V_{EN/SS}=0V$, $V_{LX}=0V$			10	μA
High-Side MOSFET Current Limit (Note 3)	$I_{LIMIT(HS)}$	Minimum Duty		3.5		A
Oscillation Frequency	F_{OSC}		400	500	600	kHz
Short Circuit Oscillation Frequency	$F_{OSC(short)}$	$V_{FB}=0V$		150		kHz
Maximum Duty Cycle	D_{MAX}	$V_{FB}=0.4V$		85		%
Minimum On Time (Note 3)	T_{MIN}			100		ns
Input Supply Voltage UVLO Threshold	$V_{UVLO(Vth)}$	V_{IN} Rising		4.3		V
Input Supply Voltage UVLO Threshold Hysteresis	$V_{UVLO(HYS)}$			400		mV
E Input Low Voltage	$V_{EN/SS(L)}$				0.4	V
E Input High Voltage	$V_{EN/SS(H)}$		2			V
Thermal Shutdown Threshold (Note 3)	T_{SD}			160		$^{\circ}C$

Note 3 : Not production tested.

Typical Performance Curves

$V_{IN}=12V$, $V_{OUT}=3.3V$, $C1=10\mu F \times 2$, $C2=22\mu F \times 2$, $L1=4.7\mu H$, $T_A=+25^\circ C$, unless otherwise noted.

$I_{OUT}=0A$

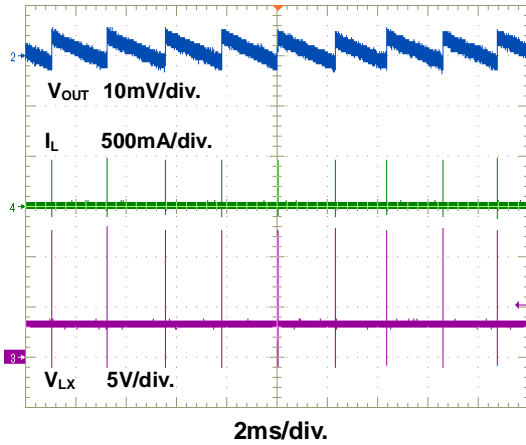

Figure 5. Steady State Waveform

$I_{OUT}=2A$

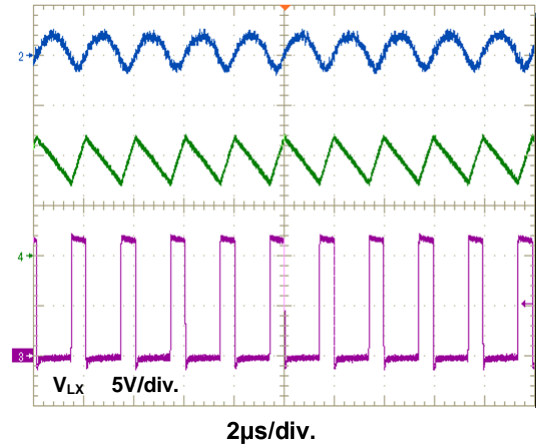

Figure 6. Steady State Waveform

$I_{OUT}=0A$

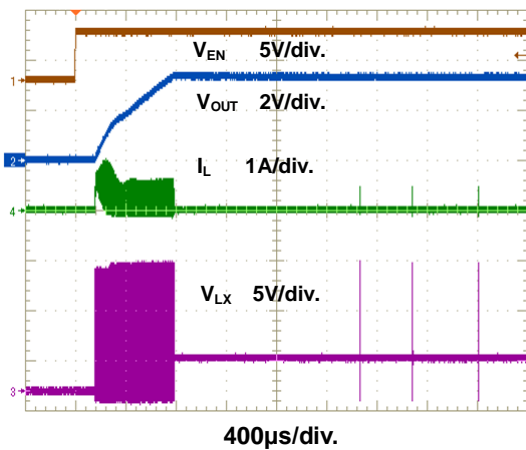

Figure 7. Power On through EN/SS Waveform

$I_{OUT}=2A$

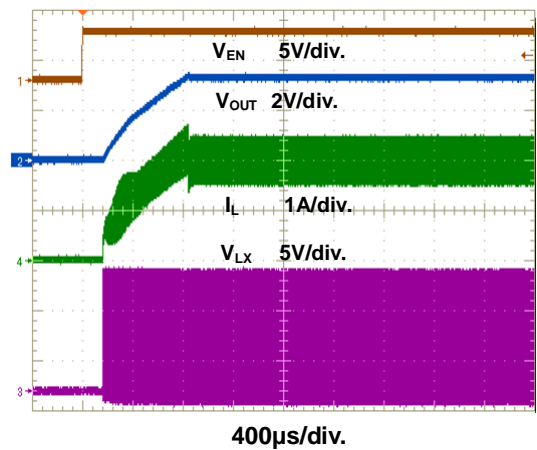

Figure 8. Power On through EN/SS Waveform

$I_{OUT}=0A$

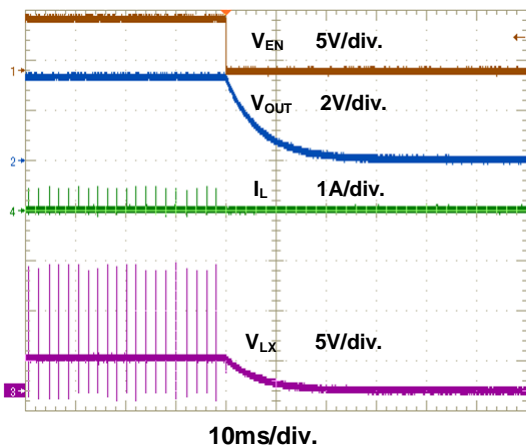

Figure 9. Power Off through EN/SS Waveform

$I_{OUT}=2A$

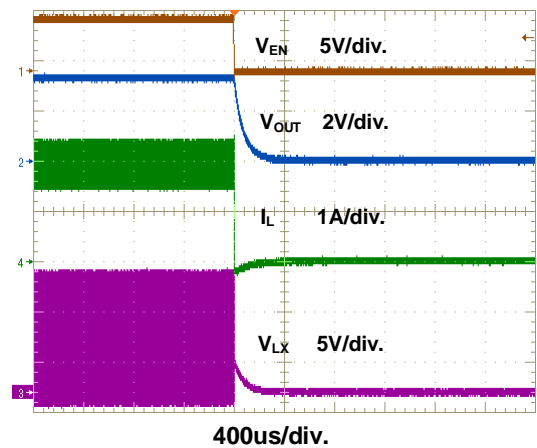

Figure 10. Power Off through EN/SS Waveform

Typical Performance Curves (Continued)

$V_{IN}=12V$, $V_{OUT}=3.3V$, $C1=10\mu F \times 2$, $C2=22\mu F \times 2$, $L1=4.7\mu H$, $T_A=+25^\circ C$, unless otherwise noted.

$I_{OUT}=0A$

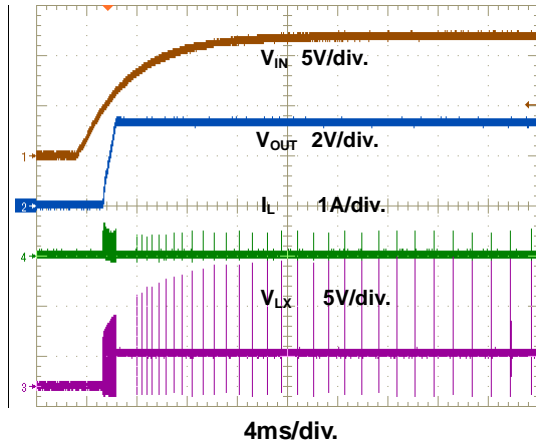

Figure 11. Power On through VIN Waveform

$I_{OUT}=2A$

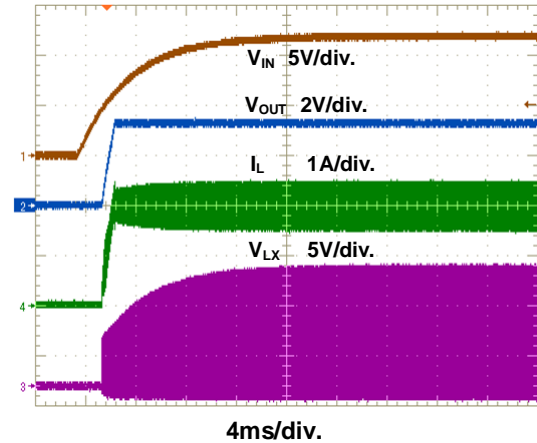

Figure 12. Power On through VIN Waveform

$I_{OUT}=0A$

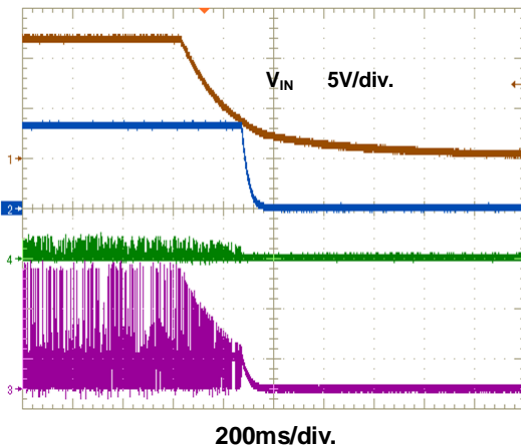

Figure 13. Power Off through VIN Waveform

$I_{OUT}=2A$

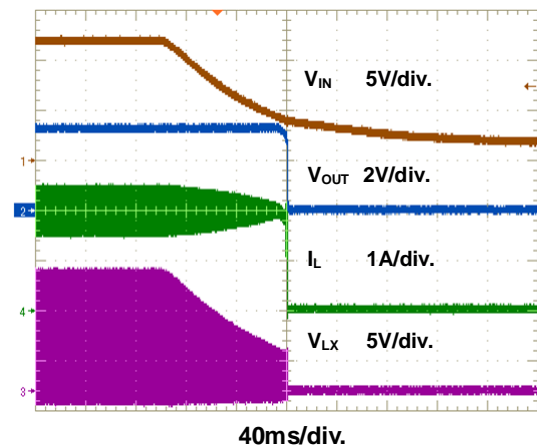

Figure 14. Power Off through VIN Waveform

$I_{OUT}=0.1A$ to $2A$

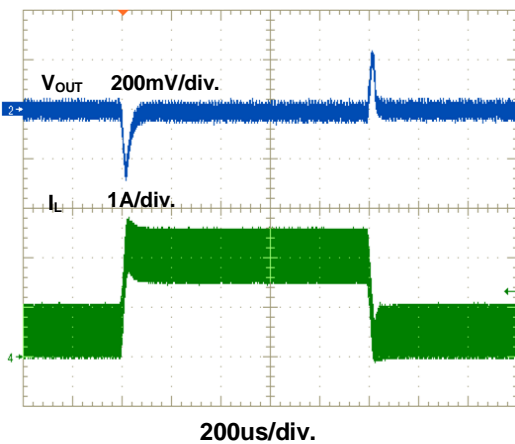

Figure 15. Load Transient Waveform

V_{OUT} Short to GND

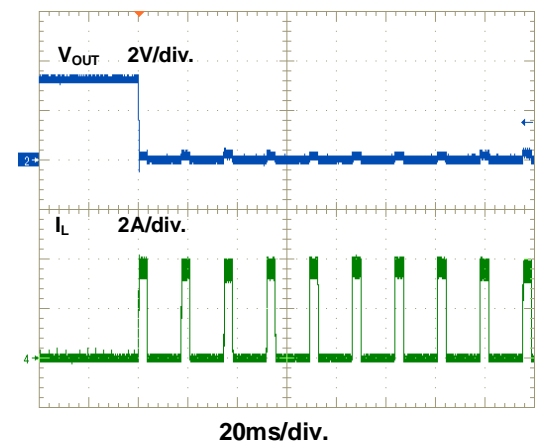

Figure 16. Short Circuit Protection

Typical Performance Curves (Continued)

$V_{IN}=12V$, $C1=10\mu F \times 2$, $C2=22\mu F \times 2$, $L1=4.7\mu H$, $T_A=+25^\circ C$, unless otherwise noted.

$V_{OUT}=1.2V$

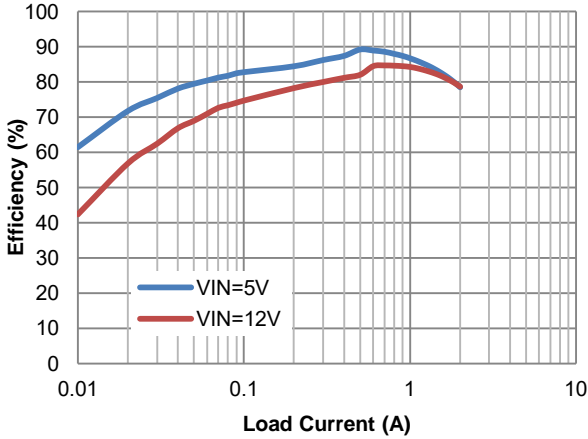

Figure 17. Efficiency vs. Load Current

$V_{OUT}=3.3V$

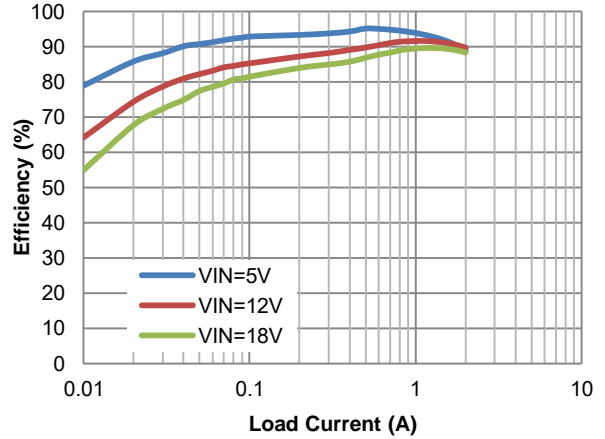

Figure 18. Efficiency vs. Load Current

$V_{OUT}=5V$

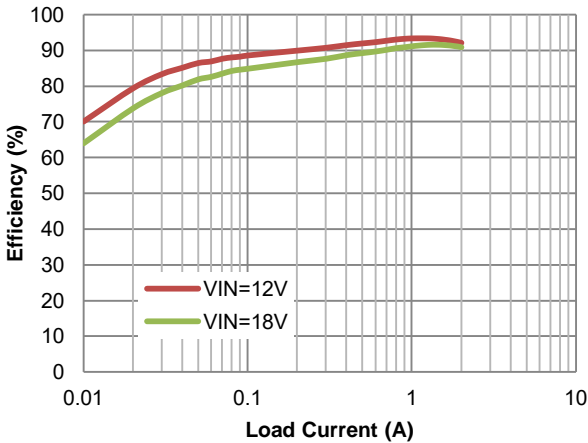

Figure 19. Efficiency vs. Load Current

$I_{OUT}=600mA$

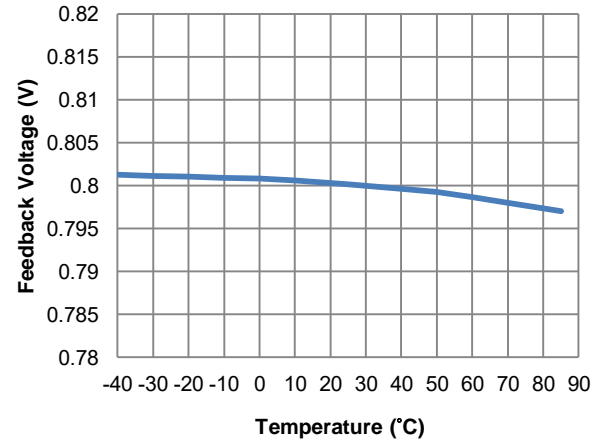

Figure 20. Feedback Voltage vs. Temperature

$I_{OUT}=600mA$

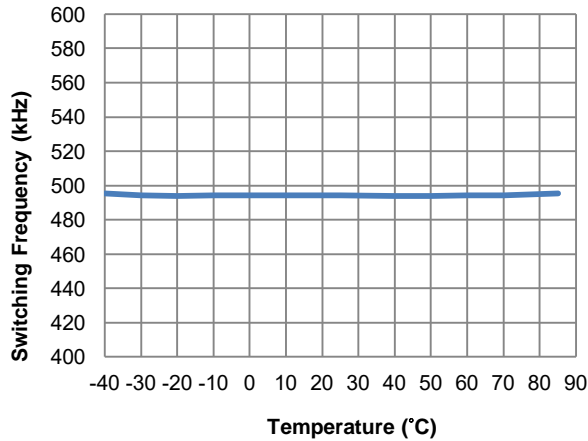

Figure 21. Switching Frequency vs. Temperature

Function Description

The FR9883 is a high efficiency, internal compensation, and constant frequency current mode step-down synchronous DC/DC converter. It has integrated high-side (145mΩ, typ) and low-side (90mΩ, typ) power switches, and provides 2A load current. It regulates input voltage from 4.5V to 18V, and down to an output voltage as low as 0.8V.

Internal Compensation Function

The stability of the feedback circuit is controlled through internal compensation circuits. This internal compensation function is optimized for most applications and this function can reduce external R, C components.

Enable

The FR9883 EN/SS pin includes enable and soft-start function. Enable function provides digital control to turn on/off the converter. When the voltage of EN/SS exceeds the threshold voltage, soft-start function will start. If EN/SS voltage is below the shutdown threshold voltage, the converter will turn into the shutdown mode. Soft-start function employs external EN/SS resistor to control soft-start period to reduce inrush current during start up. Please refer to P.10 for soft-start setting.

Input Under Voltage Lockout

When the FR9883 is power on, the internal circuits are held inactive until V_{IN} voltage exceeds the input UVLO threshold voltage. And the regulator will be disabled when V_{IN} is below the input UVLO threshold voltage. The hysteresis of the UVLO comparator is 400mV (typ).

Over Current Protection

The FR9883 over current protection function is implemented using cycle-by-cycle current limit architecture. The inductor current is monitored by measuring the high-side MOSFET series sense resistor voltage. When the load current increases, the inductor current also increases. When the peak inductor current reaches the current limit threshold, the output voltage starts to drop. When the over current condition is removed, the output voltage returns to the regulated value.

Short Circuit Protection

The FR9883 provides short circuit protection function to prevent the device damage from short condition. When the short condition occurs and the feedback voltage drops lower than 0.4V, the oscillator frequency will be decreased and hiccup mode will be triggered to prevent the inductor current increasing beyond the current limit. Once the short condition is removed, the frequency will return to normal.

Over Temperature Protection

The FR9883 incorporates an over temperature protection circuit to protect itself from overheating. When the junction temperature exceeds the thermal shutdown threshold temperature, the regulator will be shutdown. And the hysteresis of the over temperature protection is 30°C (typ).

Application Information

Soft-Start Time Setting

Power on(VIN control)

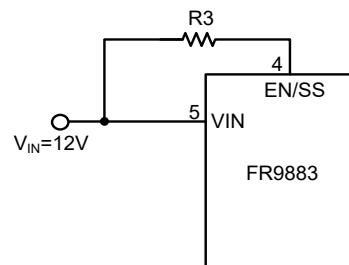
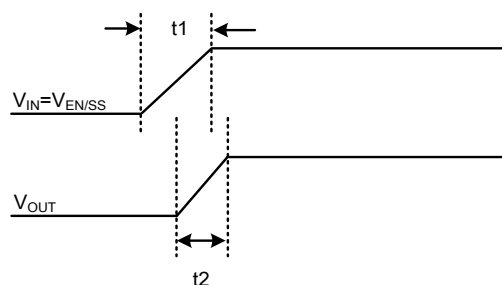

Power on(EN control)

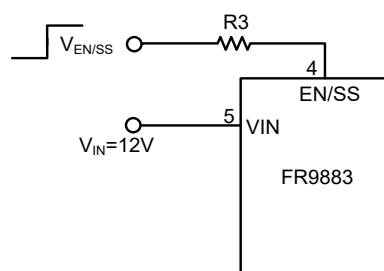
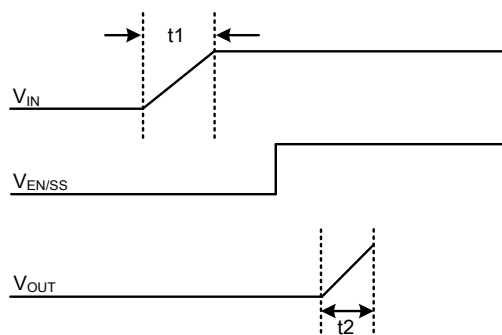

Parameters Description

Parameters	Description	Value
V_{IN}	Input operation voltage	12V
$V_{EN/SS}$	Enable & soft-start operation voltage	5V
$t1$	V_{IN} rising time	12ms
$t2$	V_{OUT} soft-start time	soft-start period depends on R3 resistor adjustment

Figure 22. Soft-Start Control Diagram

Soft-start time depends on EN/SS resistor adjustment

R3 (Ω)	V_{IN} control	$V_{EN/SS}$ control
	Soft-Start Time (ms)	
0	0.5	0.5
100k	1	1
500k	5	5

Table 2. Soft-Start Setting

Application Information (Continued)

Output Voltage Setting

The output voltage V_{OUT} is set using a resistive divider from the output to FB. The FB pin regulated voltage is 0.8V. Thus the output voltage is:

$$V_{T=0} = V \left(1 + \frac{R1}{R2} \right)$$

Table 3 lists recommended values of R1 and R2 for most used output voltage.

Table 3 Recommended Resistance Values

V_{OUT}	R1	R2
5V	30.9k Ω	5.76k Ω
3.3V	30.9k Ω	9.76k Ω
2.5V	4.99k Ω	2.32k Ω
1.8V	4.99k Ω	3.92k Ω
1.2V	4.99k Ω	10k Ω

Place resistors R1 and R2 close to FB pin to prevent stray pickup.

Input Capacitor Selection

The use of the input capacitor is filtering the input voltage ripple and the MOSFETS switching spike voltage. Because the input current to the step-down converter is discontinuous, the input capacitor is required to supply the current to the converter to keep the DC input voltage. The capacitor voltage rating should be 1.25 to 1.5 times greater than the maximum input voltage. The input capacitor ripple current RMS value is calculated as:

$$I_{(RMS)} = I_T \sqrt{D(1-D)}$$

$$= \frac{V_{OUT}}{V} I_T \sqrt{D(1-D)}$$

Where D is the duty cycle of the power MOSFET.

This function reaches the maximum value at $D=0.5$ and the equivalent RMS current is equal to $I_{OUT}/2$. The following diagram is the graphical representation of above equation.

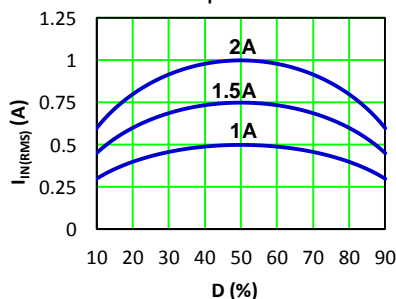

A low ESR capacitor is required to keep the noise minimum. Ceramic capacitors are better, but tantalum or low ESR electrolytic capacitors may also suffice. When using tantalum or electrolytic capacitors, a 0.1 μ F ceramic capacitor should be placed as close to the IC as possible.

Output Capacitor Selection

The output capacitor is used to keep the DC output voltage and supply the load transient current. When operating in constant current mode, the output ripple is determined by four components:

$$V_{RIPPLE}(t) = V_{RIPPLE(C)}(t) + V_{RIPPLE(ESR)}(t) + V_{RIPPLE(ESL)}(t) + V_{NOISE}(t)$$

The following figures show the form of the ripple contributions.

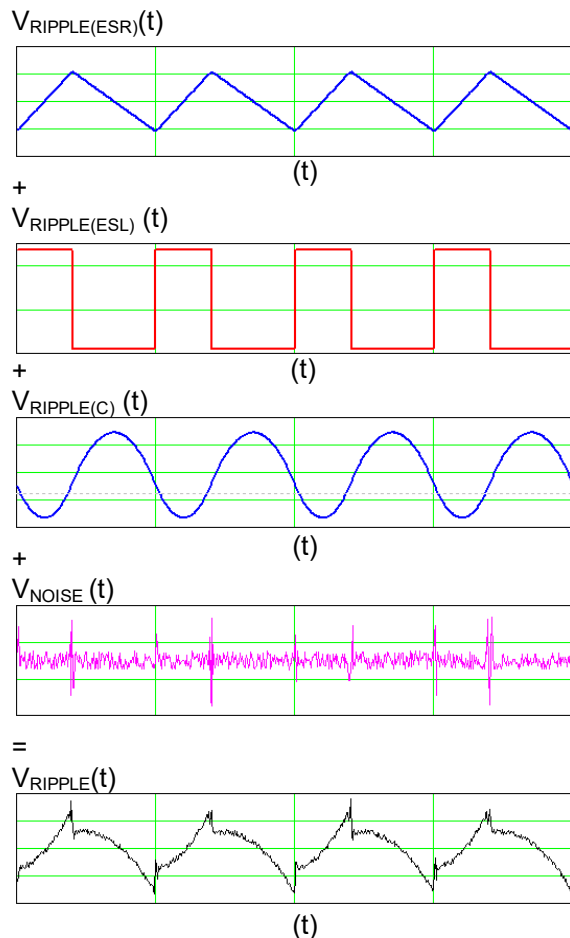

Application Information (Continued)

$$V_{RPPLE(ER)} = \frac{V_T}{F_C \times L} \left(1 - \frac{V_T}{V} \times E R \right)$$

$$V_{RPPLE(EL)} = \frac{E L}{L E L} \times V$$

$$V_{RPPLE(C)} = \frac{V_T}{\times F C^2 \times L \times C_T} \left(1 - \frac{V_T}{V} \right)$$

Where F_{OSC} is the switching frequency, L is the inductance value, V_{IN} is the input voltage, ESR is the equivalent series resistance value of the output capacitor, ESL is the equivalent series inductance value of the output capacitor and the C_{OUT} is the output capacitor.

Low ESR capacitors are preferred to use. Ceramic, tantalum or low ESR electrolytic capacitors can be used depending on the output ripple requirement. When using the ceramic capacitors, the ESL component is usually negligible.

It is important to use the proper method to eliminate high frequency noise when measuring the output ripple. The figure shows how to locate the probe across the capacitor when measuring output ripple. Removing the scope probe plastic jacket in order to expose the ground at the tip of the probe. It gives a very short connection from the probe ground to the capacitor and eliminating noise.

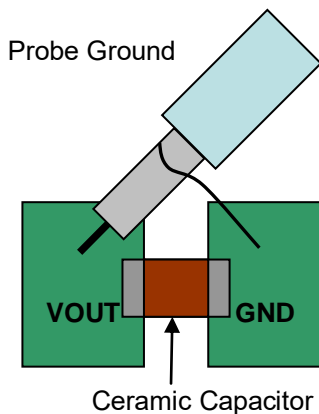

Inductor Selection

The output inductor is used for storing energy and filtering output ripple current. But the trade-off condition often happens between maximum energy storage and the physical size of the inductor. The first consideration for selecting the output inductor is to make sure that the inductance is large enough to keep the converter in the continuous current mode.

That will lower ripple current and result in lower output ripple voltage. The Δ_L is inductor peak-to-peak ripple current:

$$L = \frac{V_T}{F_C \times L} \left(1 - \frac{V_T}{V} \right)$$

The following diagram is an example to graphical represent Δ_L equation.

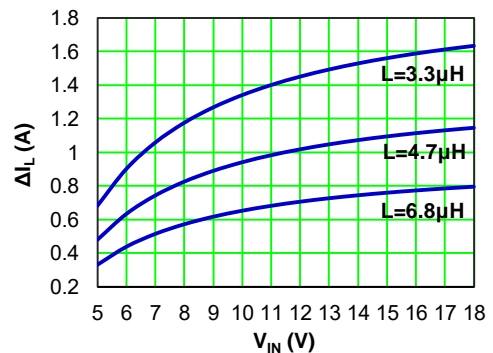

$V_{OUT}=3.3V, F_{OSC}=500kHz$

A good compromise value between size and efficiency is to set the peak-to-peak inductor ripple current Δ_L equal to 30% of the maximum load current. But setting the peak-to-peak inductor ripple current Δ_L between 20%~50% of the maximum load current is also acceptable. Then the inductance can be calculated with the following equation:

$$L = 0.3 \times I_T (MA)$$

$$L = \frac{(V - V_T) \times V_T}{V \times F_C \times L}$$

To guarantee sufficient output current, peak inductor current must be lower than the FR9883 high-side MOSFET current limit. The peak inductor current is as below:

$$I_{PEAK} = I_T (MA) + \frac{\Delta L}{2}$$

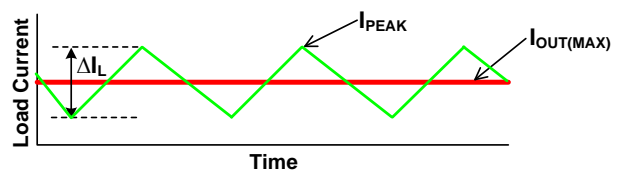

Application Information (Continued)

Feedforward Capacitor Selection

Internal compensation function allows users saving time in design and saving cost by reducing the number of external components. The use of a feedforward capacitor C4 in the feedback network is recommended to improve the transient response or higher phase margin.

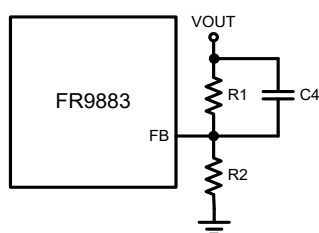

For optimizing the feedforward capacitor, knowing the cross frequency is the first thing. The cross frequency (or the converter bandwidth) can be determined by using a network analyzer. When getting the cross frequency with no feedforward capacitor identified, the value of feedforward capacitor C4 can be calculated with the following equation:

$$C = \frac{1}{2\pi F_{CR}} \sqrt{\frac{1}{R1} \left(\frac{1}{R1} + \frac{1}{R2} \right)}$$

Where F_{CROSS} is the cross frequency.

To reduce transient ripple, the feedforward capacitor value can be increased to push the cross frequency to higher region. Although this can improve transient response, it also decrease phase margin and cause more ringing. In the other hand, if more phase margin is desired, the feedforward capacitor value can be decreased to push the cross frequency to lower region. In general, the feedforward capacitor range is between 10pF to 10nF.

External Diode Selection

For 5V input applications, it is recommended to add an external boost diode. This helps improving the efficiency. The boost diode can be a low cost one such as 1N4148.

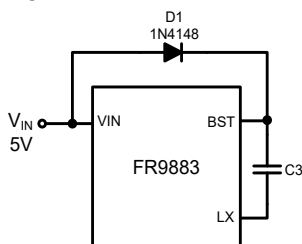

PCB Layout Recommendation

The device's performance and stability is dramatically affected by PCB layout. It is recommended to follow these general guidelines shown as below:

1. Place the input capacitors and output capacitors as close to the device as possible. Trace to these capacitors should be as short and wide as possible to minimize parasitic inductance and resistance.
2. Place feedback resistors close to the FB pin.
3. Keep the sensitive signal (FB) away from the switching signal (LX).
4. Multi-layer PCB design is recommended.

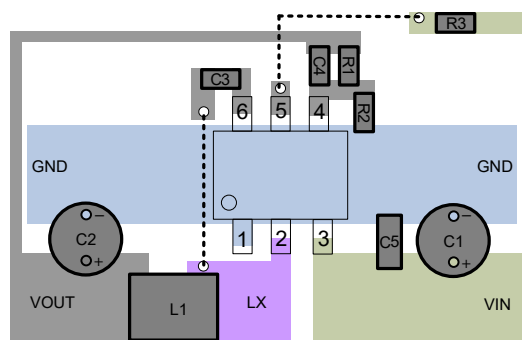
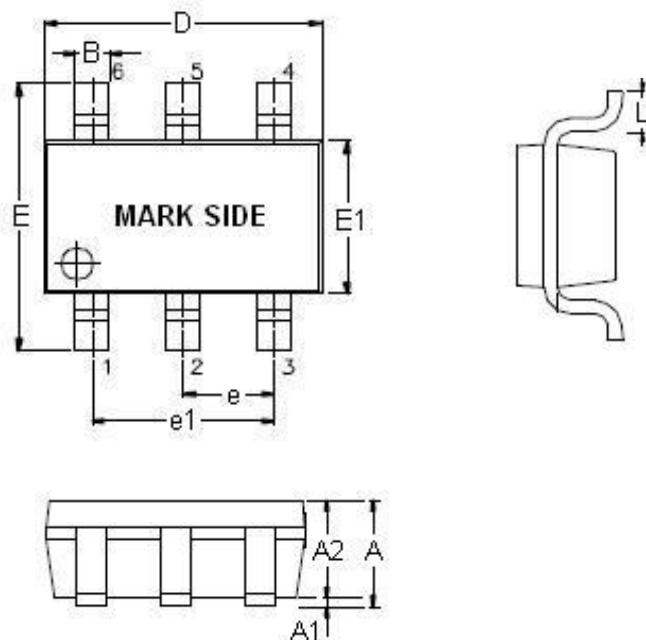

Figure 23. Recommended PCB Layout Diagram

Outline Information

SOT-23-6 Package (Unit: mm)



SYMBOLS UNIT	DIMENSION IN MILLIMETER	
	MIN	MAX
A	0.90	1.45
A1	0.00	0.15
A2	0.90	1.30
B	0.30	0.50
D	2.80	3.00
E	2.60	3.00
E1	1.50	1.70
e	0.90	1.00
e1	1.80	2.00
L	0.30	0.60

Note : Followed From JEDEC MO-178-C.

Carrier Dimensions

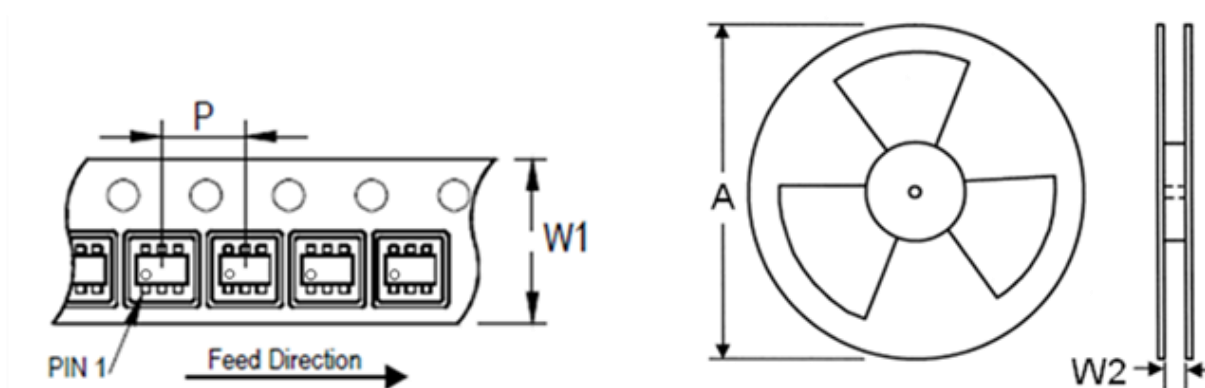

Tape Size (W1) mm	Pocket Pitch (P) mm	Reel Size (A)		Reel Width (W2) mm	Empty Cavity Length mm	Units per Reel
		in	mm			
8	4	7	180	8.4	300~1000	3,000