

## Low Dropout Voltage Regulator

### ■ GENERAL DESCRIPTION

The NJM2871B/72B are low dropout voltage regulator designed for cellular phone applications.

Advanced Bipolar technology achieves low noise, high ripple rejection and low quiescent current.

### ■ PACKAGE OUTLINE

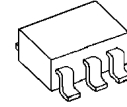

NJM2871BF/72BF

### ■ FEATURES

- High Ripple Rejection      75dB typ. (f=1kHz Vo=3V version)
- Output Noise Voltage      Vno=30μVrms typ. (Cp=0.01μF)
- Output capacitor with 1.0uF ceramic capacitor(Vo≥2.7V: Version)
- Output Current              Io(max.)=150mA
- High Precision Output      Vo ±1.0%
- Low Dropout Voltage      0.10V typ. (Io=60mA)
- Input Voltage Range      +2.3 ~ +14V(Vo≤2.0V version)
- ON/OFF Control              (Active High)
- Internal Short Circuit Current Limit
- Internal Thermal Overload Protection
- Bipolar Technology
- Package Outline              SOT-23-5 (MTP5)

### ■ PIN CONFIGURATION

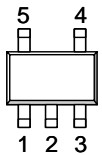

NJM2871BF

1. CONTROL (Active High)
2. GND
3. NOISE BYPASS
4. V<sub>OUT</sub>
5. V<sub>IN</sub>

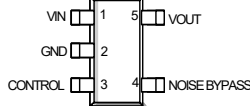

NJM2872BF

1. V<sub>IN</sub>
2. GND
3. CONTROL (Active High)
4. NOISE BYPASS
5. V<sub>OUT</sub>

### ■ EQUIVALENT CIRCUIT

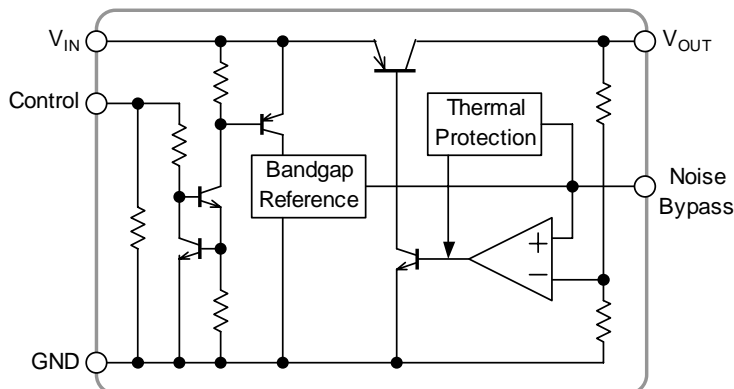

# NJM2871B/72B

## ■ OUTPUT VOLTAGE RANK LIST

Device Name	V <sub>OUT</sub>	Device Name	V <sub>OUT</sub>	Device Name	V <sub>OUT</sub>
NJM287*BF15	1.5V	NJM287*BF26	2.6V	NJM287*BF34	3.4V
NJM287*BF18	1.8V	NJM287*BF27	2.7V	NJM287*BF35	3.5V
NJM287*BF19	1.9V	NJM287*BF28	2.8V	NJM287*BF38	3.8V
NJM287*BF02	2.0V	NJM287*BF29	2.9V	NJM287*BF04	4.0V
NJM287*BF21	2.1V	NJM287*BF03	3.0V	NJM287*BF48	4.8V
NJM287*BF23	2.3V	NJM287*BF31	3.1V	NJM287*BF05	5.0V
NJM287*BF24	2.4V	NJM287*BF32	3.2V		
NJM287*BF25	2.5V	NJM287*BF33	3.3V		

## ■ ABSOLUTE MAXIMUM RATINGS

(Ta=25°C)

PARAMETER	SYMBOL	RATINGS	UNIT	
Input Voltage	V <sub>IN</sub>	+14	V	
Control Voltage	V <sub>CONT</sub>	+14(*1)	V	
Power Dissipation	P <sub>D</sub>	SOT-23-5	350(*2)	mW
			200(*3)	
Operating Temperature	T <sub>opr</sub>	-40 ~ +85	°C	
Storage Temperature	T <sub>stg</sub>	-40 ~ +125	°C	

(\*1) : When input voltage is less than +14V, the absolute maximum control voltage is equal to the input voltage.

(\*2) : Mounted on glass epoxy board based on EIA/JEDEC. (114.3x76.2x1.6mm: 2Layers)

(\*3) : Device itself

## ■ Operating voltage

V<sub>IN</sub>=+2.3 ~ +14V (In case of Vo<2.1V version)

## ■ ELECTRICAL CHARACTERISTICS

(V<sub>IN</sub>=Vo+1V, C<sub>IN</sub>=0.1μF, C<sub>O</sub>=1.0μF: Vo≥2.7V (C<sub>O</sub>=2.2μF : 1.8V<Vo≤2.6V, C<sub>O</sub>=4.7μF : Vo≤1.8V), C<sub>p</sub>=0.01μF, Ta=25°C)

PARAMETER	SYMBOL	TEST CONDITION	MIN.	TYP.	MAX.	UNIT
Output Voltage	V <sub>o</sub>	I <sub>o</sub> =30mA	-1.0%	-	+1.0%	V
Quiescent Current	I <sub>q</sub>	I <sub>o</sub> =0mA, except I <sub>cont</sub>	-	120	180	μA
Quiescent Current at Control OFF	I <sub>q(OFF)</sub>	V <sub>CONT</sub> =0V	-	-	100	nA
Output Current	I <sub>o</sub>	V <sub>o</sub> =0.3V	150	200	-	mA
Line Regulation	ΔV <sub>o</sub> /ΔV <sub>IN</sub>	V <sub>IN</sub> =Vo+1V ~ Vo+6V, I <sub>o</sub> =30mA	-	-	0.10	%/V
Load Regulation	ΔV <sub>o</sub> /ΔI <sub>o</sub>	I <sub>o</sub> =0 ~ 100mA	-	-	0.03	%/mA
Dropout Voltage (*4)	ΔV <sub>LO</sub>	I <sub>o</sub> =60mA	-	0.10	0.18	V
Ripple Rejection	RR	e <sub>in</sub> =200mVrms, f=1kHz, I <sub>o</sub> =10mA, V <sub>o</sub> =3V version	-	75	-	dB
Average Temperature Coefficient of Output Voltage	ΔV <sub>o</sub> /ΔTa	Ta=0 ~ +85°C, I <sub>o</sub> =10mA	-	±50	-	ppm/°C
Output Noise Voltage	V <sub>NO1</sub>	f=10Hz-80kHz, I <sub>o</sub> =10mA, V <sub>o</sub> =3V Version	-	30	-	μVrms
Control Voltage for ON-state	V <sub>CONT(ON)</sub>		1.6	-	-	V
Control Voltage for OFF-state	V <sub>CONT(OFF)</sub>		-	-	0.6	V

(\*4): The output voltage excludes under 2.1V.

The above specification is a common specification for all output voltages.

Therefore, it may be different from the individual specification for a specific output voltage.

## ■ TEST CIRCUIT

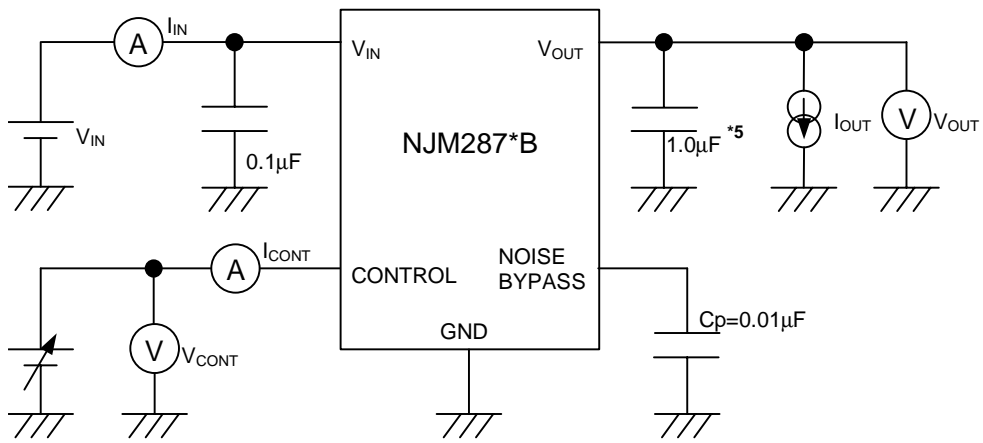

\*5 1.8V <  $V_o$  ≤ 2.6V version :  $C_o = 2.2\mu\text{F}$   
 $V_o \leq 1.8\text{V}$  version :  $C_o = 4.7\mu\text{F}$

# NJM2871B/72B

## ■ TYPICAL APPLICATION

① In the case where ON/OFF Control is not required:

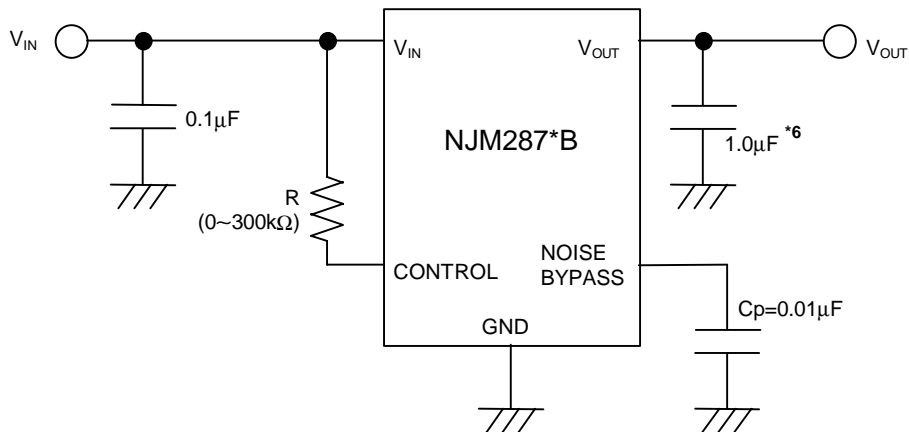

\*6 1.8V <math>V\_o \le 2.6V</math> version :  $C_o = 2.2\mu F$   
 $V_o \le 1.8V$  version :  $C_o = 4.7\mu F$

Connect control terminal to  $V_{IN}$  terminal

② In use of ON/OFF CONTROL:

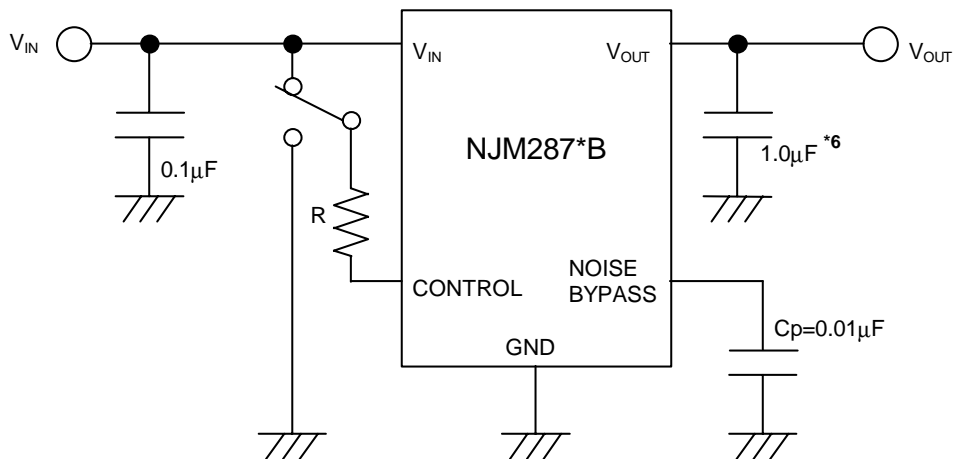

\*6 1.8V <math>V\_o \le 2.6V</math> version :  $C_o = 2.2\mu F$  (ceramic)  
 $V_o \le 1.8V$  version :  $C_o = 4.7\mu F$  (ceramic)

State of control terminal:

- "H" → output is enabled.
- "L" or "open" → output is disabled.

### \*Noise bypass Capacitance $C_p$

Noise bypass capacitance  $C_p$  reduces noise generated by band-gap reference circuit. Noise level and ripple rejection will be improved when larger  $C_p$  is used. Use of smaller  $C_p$  value may cause oscillation. Use the  $C_p$  value of  $0.01\mu F$  greater to avoid the problem.

### \*In the case of using a resistance "R" between $V_{IN}$ and control.

The current flow into the control terminal while the IC is ON state ( $I_{CONT}$ ) can be reduced when a pull up resistance "R" is inserted between  $V_{IN}$  and the control terminal.

The minimum control voltage for ON state ( $V_{CONT(ON)}$ ) is increased due to the voltage drop caused by  $I_{CONT}$  and the resistance "R". The  $I_{CONT}$  is temperature dependence as shown in the "Control Current vs. Temperature" characteristics. Therefore, the resistance "R" should be carefully selected to ensure the control voltage exceeds the  $V_{CONT(ON)}$  over the required temperature range.

## POWER DISSIPATION vs. AMBIENT TEMPERATURE

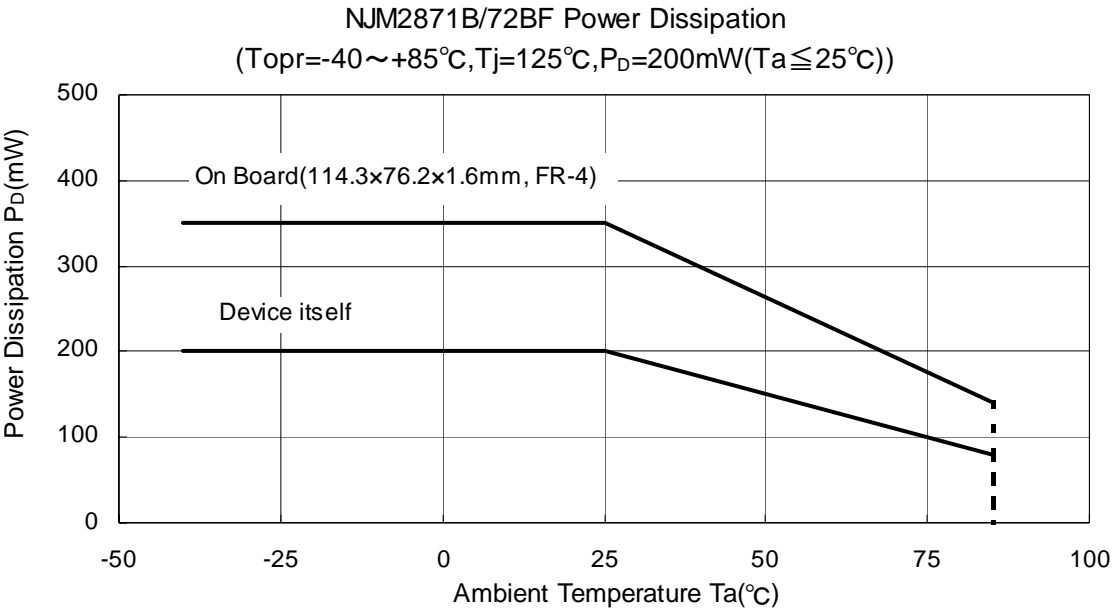

# NJM2871B/72B

## ELECTRICAL CHARACTERISTICS

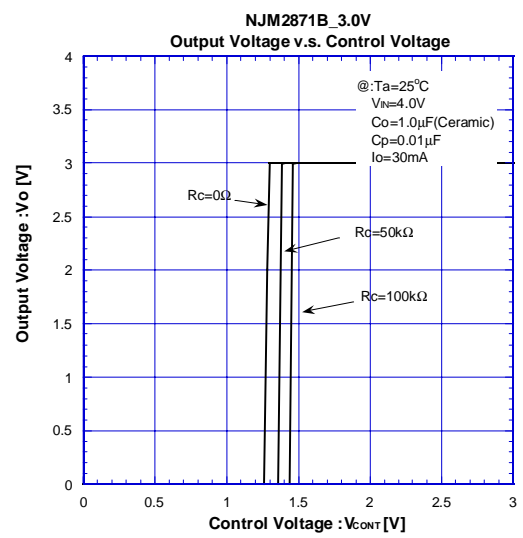
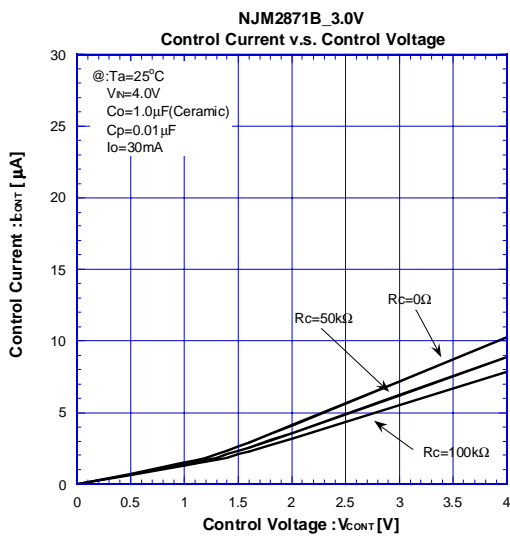
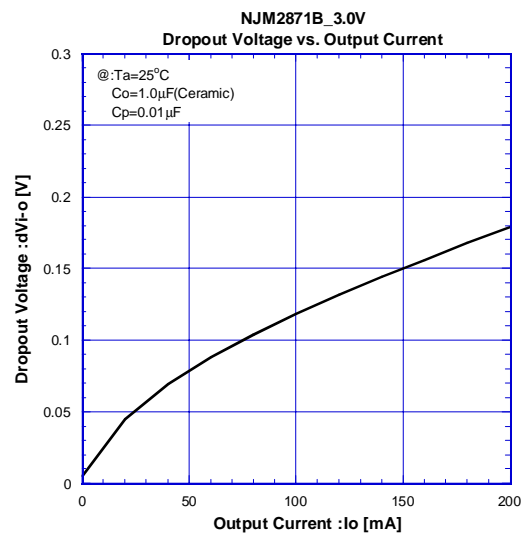
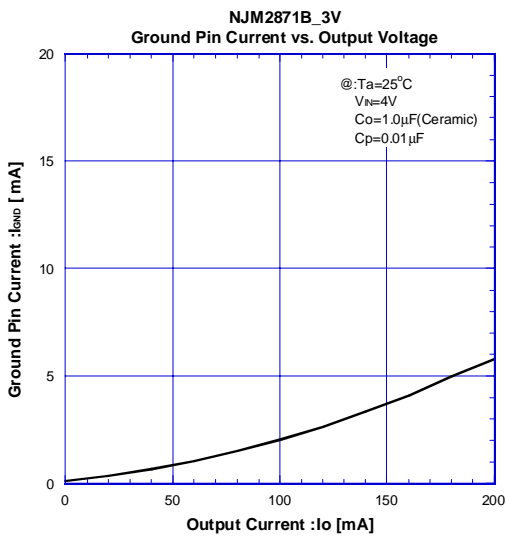
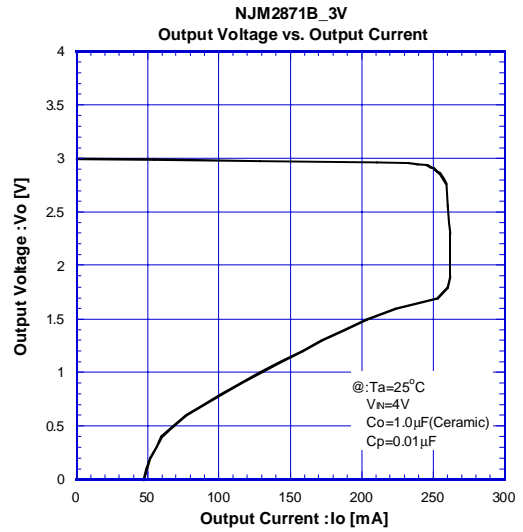
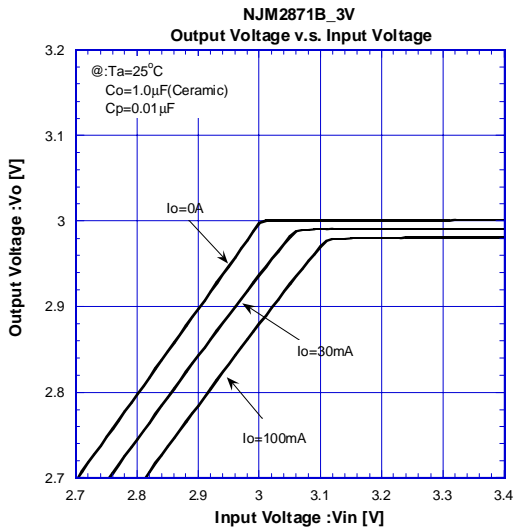

## ELECTRICAL CHARACTERISTICS

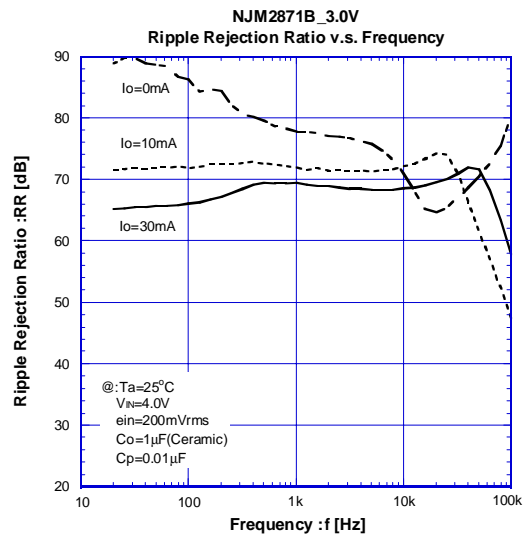
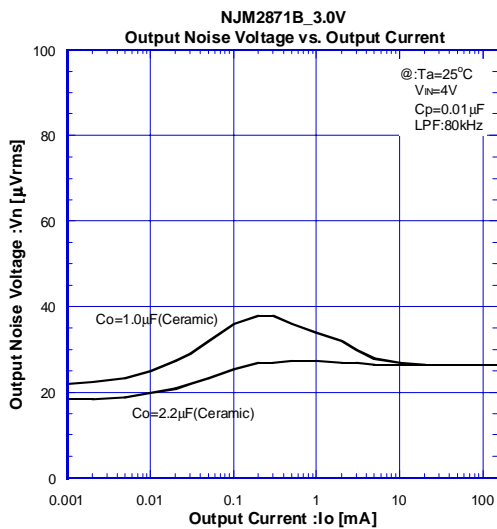
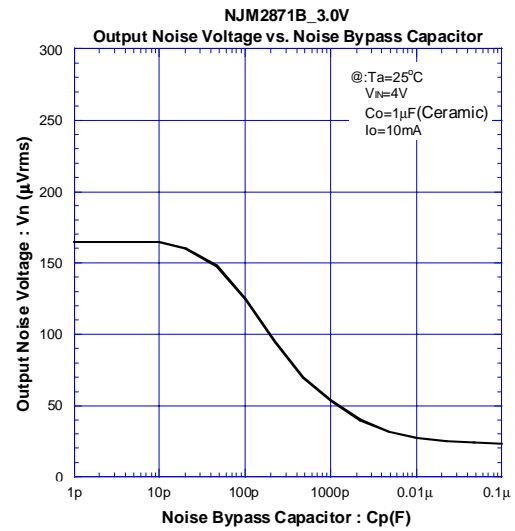
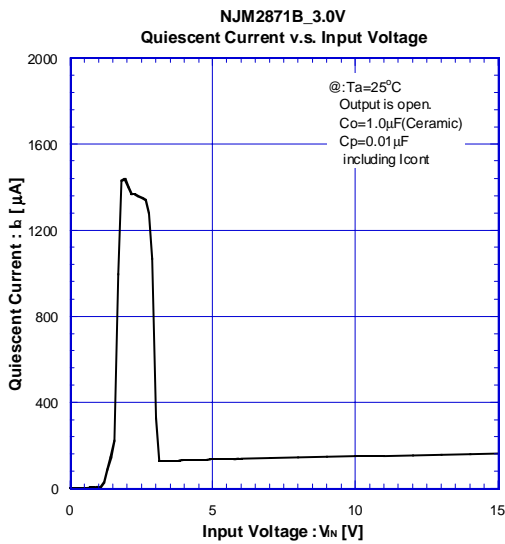
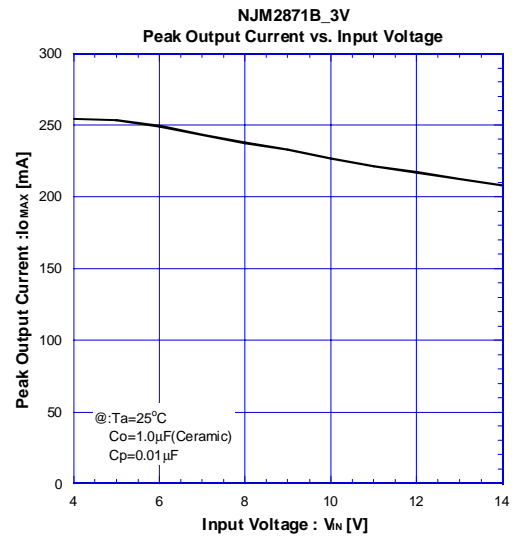
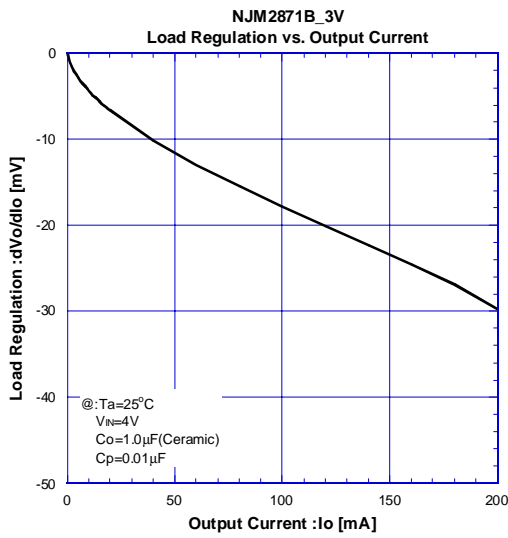

# NJM2871B/72B

## ELECTRICAL CHARACTERISTICS

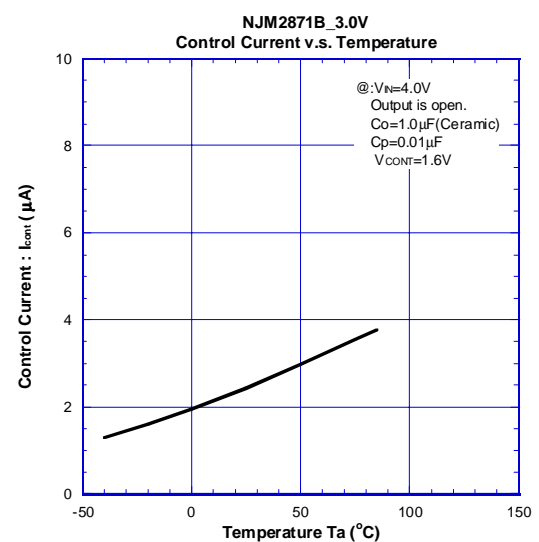
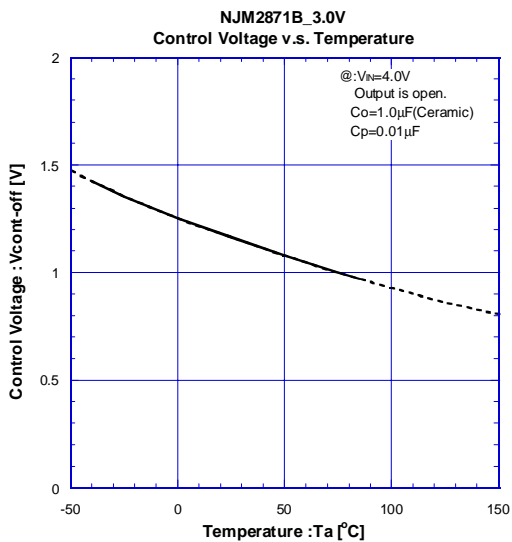
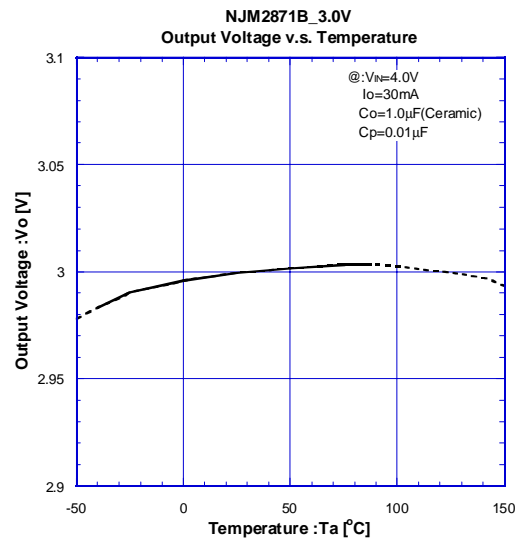
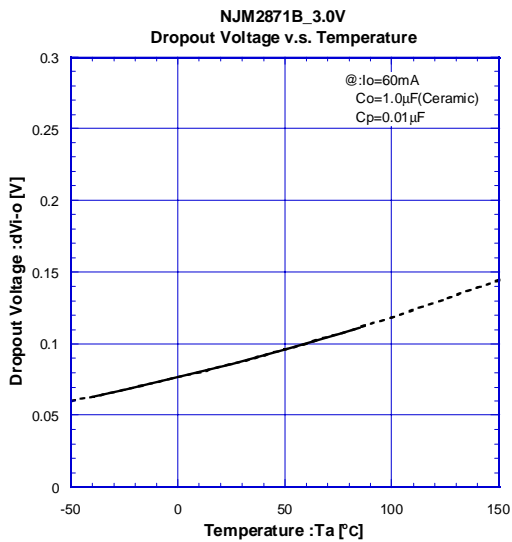
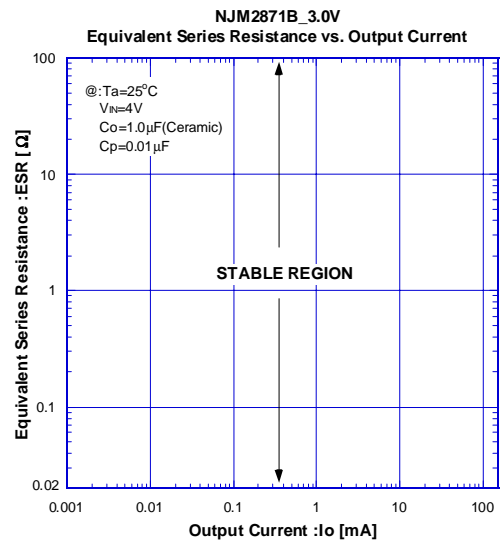
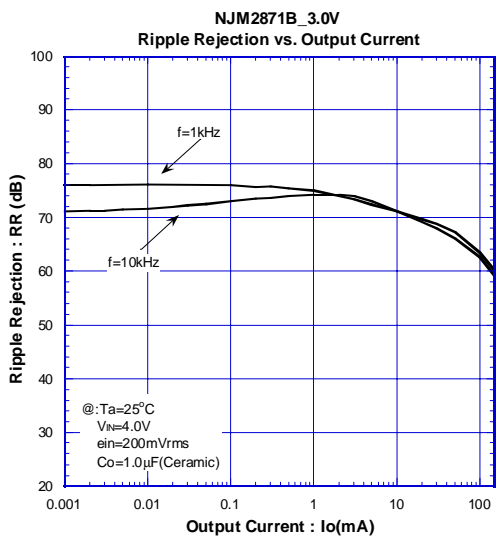



## ELECTRICAL CHARACTERISTICS

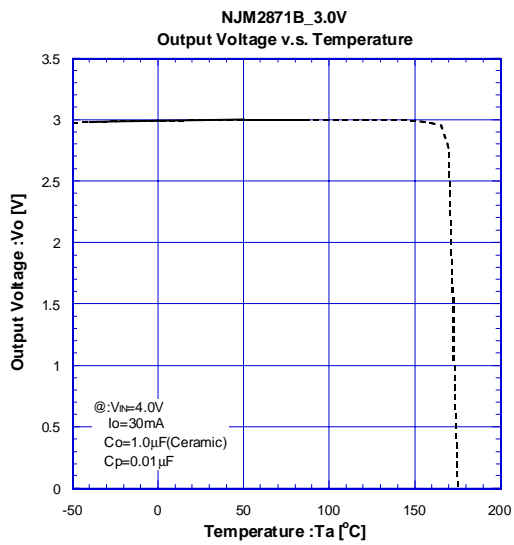
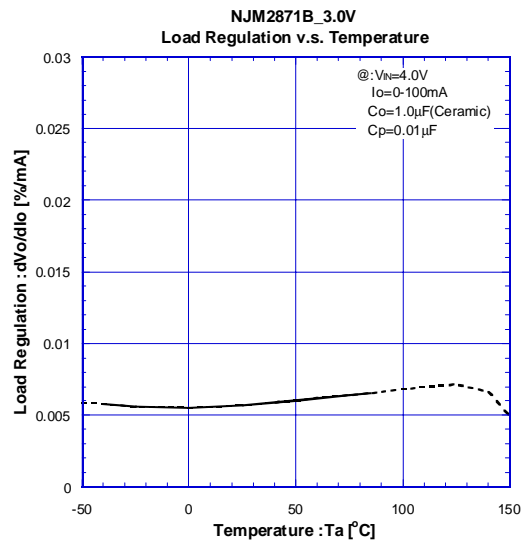
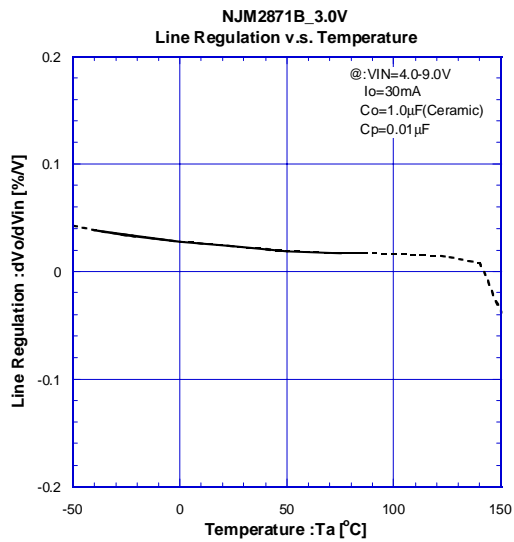
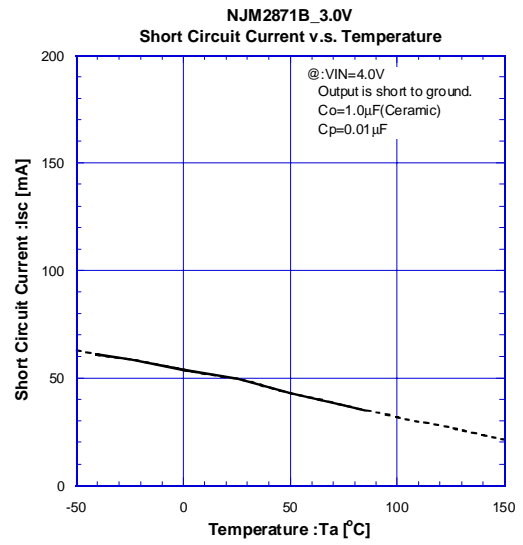
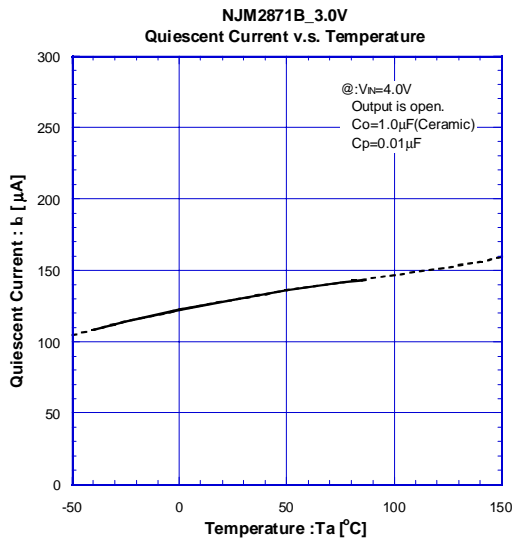

# NJM2871B/72B

## ■ ELECTRICAL CHARACTERISTICS

