

General Description

MXD8015H high gain, low noise amplifier (LNA) is dedicated to LTE middle band and high band receive using advanced RFCMOS process. The high linearity performance and low noise figure makes the device an ideal choice for LTE receiving Applications.

MXD8015H works under a 1.6V to 3.3V single power supply while consumes 6 mA current in low noise mode, in power down mode, the power consumption will be reduced to less than 1uA.

MXD8015H uses a small 1.1mm × 0.7mm × 0.45mm LGA 6-pin package.

Applications

- LTE high-mid band receiving

Features

- Broadband frequency range: 1.8 to 2.7 GHz
- High Gain
 - 15.5dB gain at 1.8GHz to 2.2GHz
 - 14.5dB gain at 2.3GHz to 2.7GHz
- Low noise figure
 - 0.65dB noise figure at 1.8GHz to 2.2GHz
 - 0.70dB noise figure at 2.3GHz to 2.7GHz
- Operation current 6mA
- Small, LGA (6-pin, 1.1mm x 0.7mm x 0.45mm) package , MSL1
- No DC blocking capacitors required.

Pin Configuration/Application Diagram (Top view)

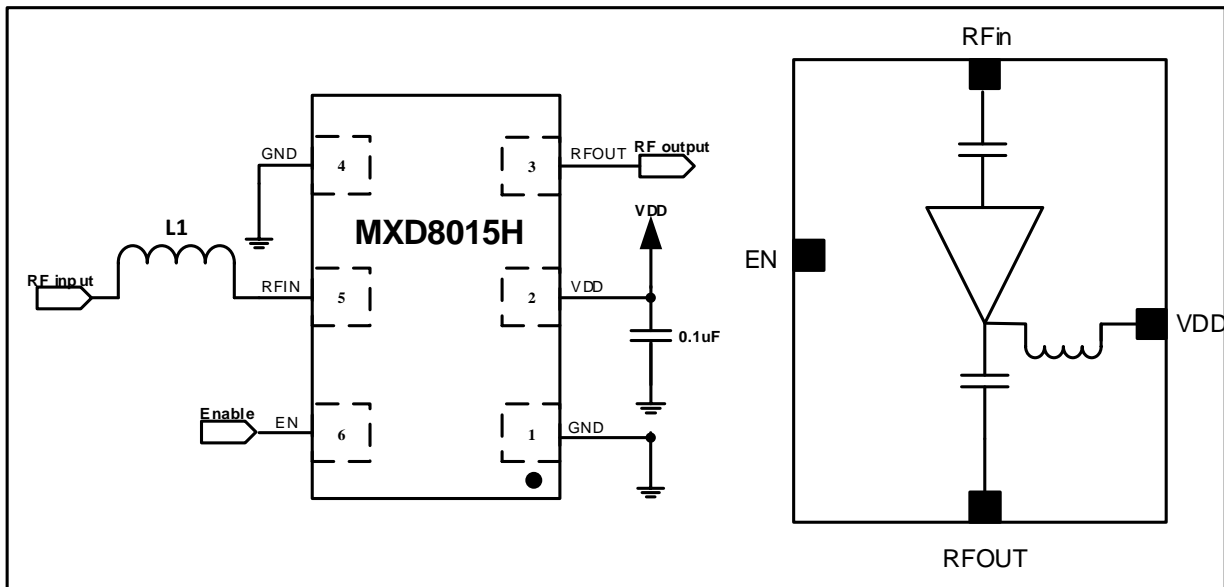

Figure 1 MXD8015H application circuit

Pin Descriptions & Input matching inductance

Table 1

Pin	Pin Name	I/O	Pin Description
1	GND	AG	Analog VSS
2	VDD	AP	Power supply
3	RFOUT	AO	LNA output
4	GND	AG	Analog VSS
5	RFIN	AI	LNA input from antenna
6	EN	DI	Pull high into low noise mode, pull low into power down mode

Note: *DI* (digital input), *DO* (digital output), *DIO* (digital bidirectional), *AI* (analog input), *AO* (analog output), *AIO* (analog bidirectional), *AP* (analog power), *AG* (analog ground),

Table 2 Input matching inductance

Component	Matching Band	Vendor	Type	Part Number & value
L1	1800MHz – 2200MHz	Murata	Wired inductor, high Q	LQW15AN6N8, 6.8nH
		various	Ceramic inductor, low Q	6.2nH
	2300MHz – 2700MHz	Murata	Wired inductor, high Q	LQW15AN4N3, 4.3nH
		various	Ceramic inductor, low Q	3.9nH

Recommended Operation Range

Table 3

Parameters	Symbol	Min	Typ	Max	Units
Operation Frequency	f1	1800	-	2700	MHz
Power supply	V _{DD}	1.6	2.8	3.3	V
Control Voltage High	V _{CTL_H}	1.0	1.8	VDD	V
Control Voltage Low	V _{CTL_L}	0	0	0.3	V

Absolute Maximum Ratings

Table 4 Maximum ratings

Parameters	Symbol	Minimum	Maximum	Units
Supply voltage	V _{DD}	-0.3	+3.6	V
Digital control voltage	V _{CTL}	-0.3	VDD+0.3	V
RF input power	P _{IN}	-	+20	dBm
Operating temperature	T _{OP}	-40	+90	°C
Storage temperature	T _{STG}	-65	+160	°C
Electrostatic Discharge Human body model (HBM), Class 1C ^{Note1} Machine Model (MM), Class A ^{Note2} Charged device model (CDM), Class III ^{Note3}	ESD_HBM ESD_MM ESD_CDM	-	1500 125 500	V

Note: Exposure to maximum rating conditions for extended periods may reduce device reliability. There is no damage to device with only one parameter set at the limit and all other parameters set at or below their nominal value. Exceeding any of the limits listed here may result in permanent damage to the device.

Note1: According to ESDA/JEDECJS-001-2014

Note2: According to JESD22-A115C

Note3: According to ESDA/JEDECJS-002-2014

Specifications

Typically $T_A=25^{\circ}\text{C}$ $V_{DD}=2.8\text{V}$, All data measured on Maxscend's EVB, unless otherwise noted

Table 5 High Gain mode Electrical Specifications

Parameter	Symbol	Specification			Units	Test Condition
		Min.	Typical	Max.		
DC Specifications						
Supply voltage	V_{DD}	1.6	2.8	3.3	V	
Supply current	I_{DD}	4 0	6 0.05	9 1	mA uA	$V_{DD} = 2.8\text{V}$, $V_{EN}=\text{high}$ $V_{DD} = 2.8\text{V}$, $V_{EN}=\text{low}$
RF Specifications						
Power gain	G	14 12.5	15.5 14.5	17 16.5	dB dB	1800-2200MHz 2300-2700MHz
Noise figure	NF	-	0.65 0.70	1.1 1.3	dB dB	1800-2200MHz 2300-2700MHz
Input Return loss	S11	-	-10	-5	dB	1800 to 2700MHz
Output Return loss	S22	-	-10	-6	dB	1800 to 2700MHz
Stability factor	Kf	1.2	-	-		
Input 1 dB compression point	P1dB	-10 -5	-7 -2	-	dBm dBm	1800 to 2200MHz 2300 to 2700MHz
Input IP3	IIP3	-4 -1	0 3	-	dBm dBm	Note1 Note2
Startup time		-	-	1	us	Shutdown state to power on state

Note1: Pin=Pin2=-25dBm, F1=2100MHz, F2=2101MHz

Note2: Pin=Pin2=-25dBm, F1=2600MHz, F2=2601MHz

Package Outline Dimensions

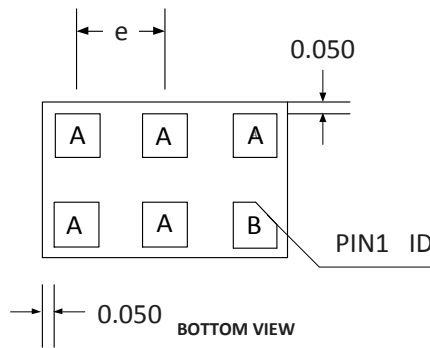
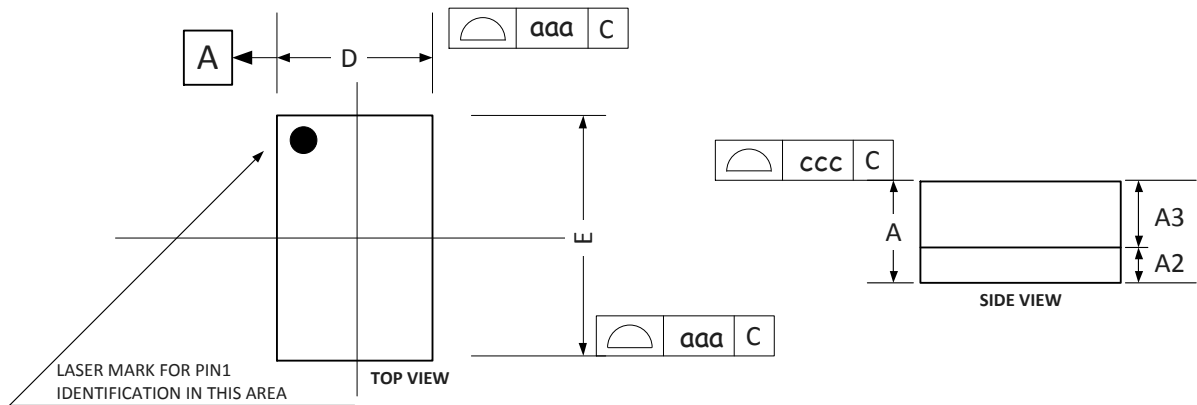

ALL DIMENSIONS ARE IN MILLIMETERS.

SYMBOL	MILLIMETER			INCH		
	MIN.	NOR.	MAX.	MIN.	NOR.	MAX.
A	0.40	0.45	0.50	0.0157	0.0177	0.0197
A2	0.09	0.12	0.15	0.0035	0.0047	0.0059
A3	0.31	0.33	0.35	0.0122	0.0130	0.0138
e	0.35	0.40	0.45	0.0138	0.0157	0.0177
D	0.65	0.70	0.75	0.0256	0.0276	0.0295
E	1.05	1.10	1.15	0.0413	0.0433	0.0453
aaa	0.10			0.0039		
ccc	0.20			0.0079		

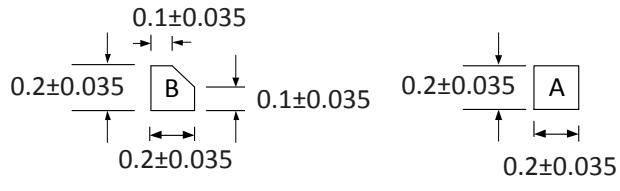

Figure 2 MXD8015H outline dimension

Marking Specification

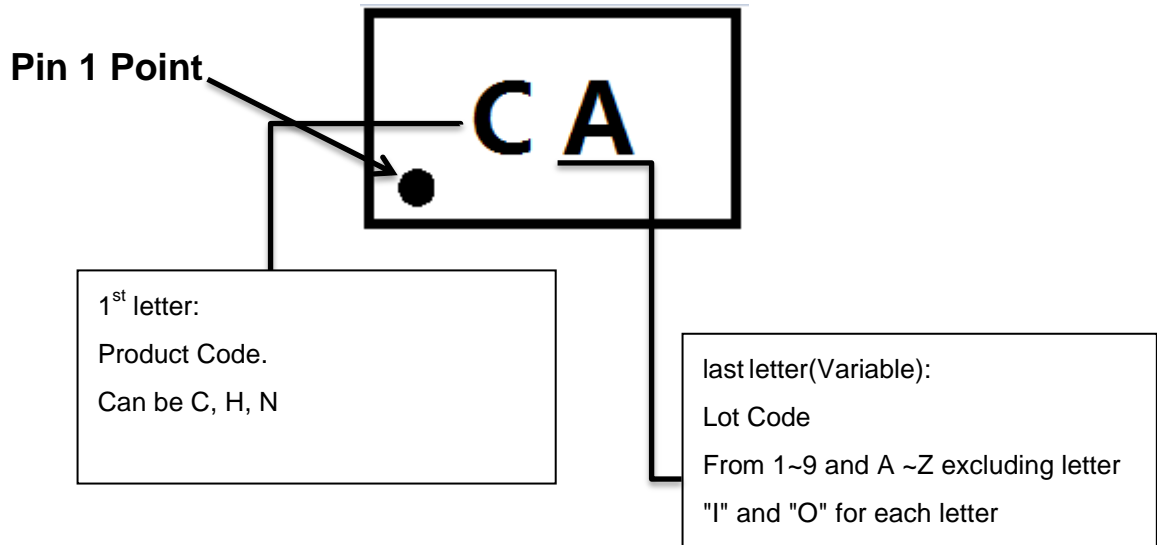

Figure 3 Marking specification (Top View)

Tape and Reel Dimensions

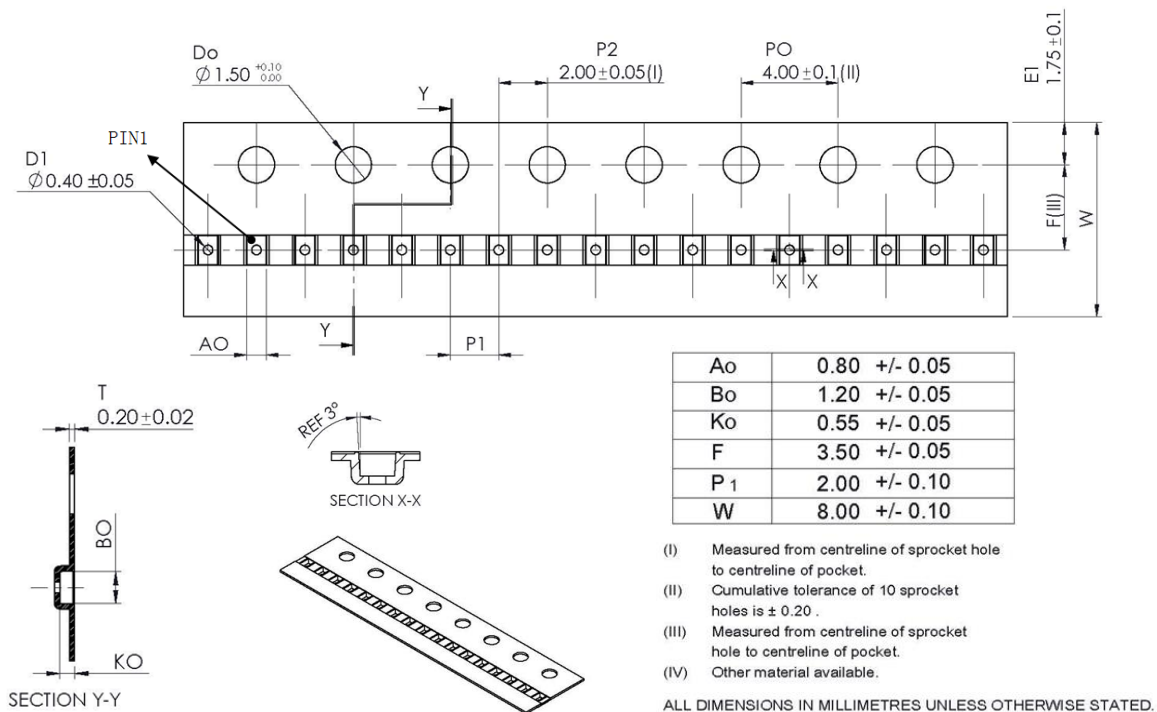

Figure 4 Tape and reel dimensions

Reflow Chart

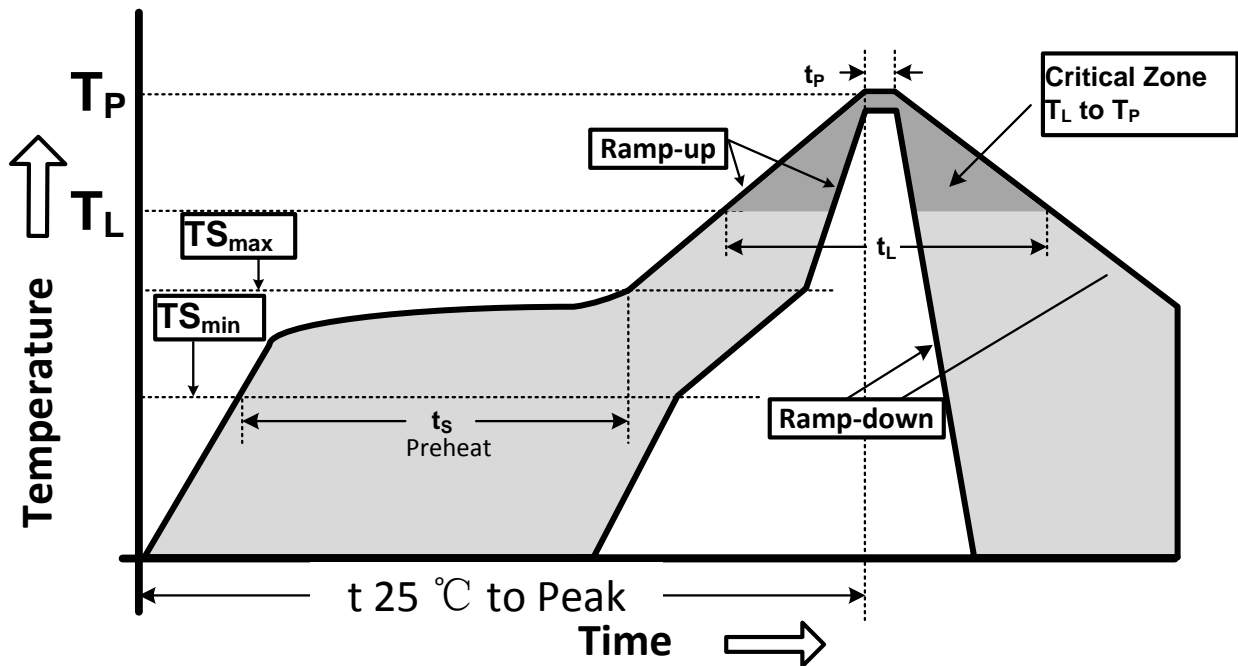

Figure 5 Recommended Lead-Free Reflow Profile

Table 6 Reflow condition

Profile Parameter	Lead-Free Assembly, Convection, IR/Convection
Ramp-up rate (TS_{max} to T_p)	3°C/second max.
Preheat temperature (TS_{min} to TS_{max})	150°C to 200°C
Preheat time (t_s)	60 - 180 seconds
Time above T_L , 217°C (t_L)	60 - 150 seconds
Peak temperature (T_p)	260°C
Time within 5°C of peak temperature(t_p)	20 - 40 seconds
Ramp-down rate	6°C/second max.
Time 25°C to peak temperature	8 minutes max.

ESD Sensitivity

Integrated circuits are ESD sensitive and can be damaged by static electric charge. Proper ESD protection techniques should be used when handling these devices.

RoHS Compliant

This product does not contain lead, mercury, cadmium, hexavalent chromium, polybrominated biphenyls (PBB) and polybrominated diphenyl ethers (PBDE), and are considered RoHS compliant.