



SGM8965-1/SGM8965-2 50MHz, Low Distortion, RRIO, Single Supply Operational Amplifiers

GENERAL DESCRIPTION

The SGM8965-1/2 zero-crossover series, rail-to-rail input and output, high-performance, CMOS operational amplifiers are optimized for low voltage, single supply applications. Rail-to-rail input and output, low noise and high speed operation make these devices ideal for driving sampling analog-to-digital converters (ADCs). Applications include audio, signal conditioning and sensor amplification. The SGM8965-1/2 family of operational amplifiers is also well-suited for cell phone power amplifier control loops.

Special features include no input stage crossover distortion, high input impedance, and rail-to-rail input and output swing. The input common mode voltage range includes both the negative and positive supplies. The output voltage swing is within 8mV of the rails.

The SGM8965-1 (single version) is available in Green SOT-23-5 and SOIC-8 packages. The SGM8965-2 (dual version) is available in Green SOIC-8 and MSOP-8 packages. All versions are specified for operation from -40°C to +125°C. Single and dual versions have identical specifications for maximum design flexibility.

FEATURES

- **Gain Bandwidth: 50MHz**
- **Excellent THD+N: 0.00015%**
- **High CMRR: 100dB (TYP)**
- **Rail-to-Rail Input and Output:**
 - Input 100mV Beyond Supply Rail**
- **Low Noise: 4.5nV/√Hz at 100kHz**
- **Slew Rate: 30V/μs**
- **High Precision:**
 - Low Offset: 250μV (MAX)**
 - Low Input Bias Current: 0.5pA (TYP)**
- **Stable When Gain ≥ 4**
- **2.2V to 5.5V Operation Voltage Range**
- **-40°C to +125°C Operating Temperature Range**
- **Small Packaging:**
 - SGM8965-1 Available in Green SOT-23-5 and SOIC-8 Packages**
 - SGM8965-2 Available in Green SOIC-8 and MSOP-8 Packages**

APPLICATIONS

Signal Conditioning
Data Acquisition
Process Control
Active Filter
Test Equipment
Audio
Wideband Amplifier

PACKAGE/ORDERING INFORMATION

MODEL	PACKAGE DESCRIPTION	SPECIFIED TEMPERATURE RANGE	ORDERING NUMBER	PACKAGE MARKING	PACKING OPTION
SGM8965-1	SOT-23-5	-40°C to +125°C	SGM8965-1XN5G/TR	SZ9XX	Tape and Reel, 3000
	SOIC-8	-40°C to +125°C	SGM8965-1XS8G/TR	SGM 89651XS8 XXXXX	Tape and Reel, 2500
SGM8965-2	SOIC-8	-40°C to +125°C	SGM8965-2XS8G/TR	SGM 89652XS8 XXXXX	Tape and Reel, 2500
	MSOP-8	-40°C to +125°C	SGM8965-2XMS8G/TR	SGM89652 XMS8 XXXXX	Tape and Reel, 4000

MARKING INFORMATION

NOTE: XX = Date Code. XXXXXX = Date Code and Vendor Code.

SOT-23-5

YYY X X

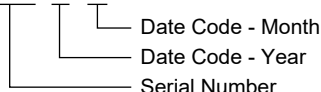

SOIC-8/MSOP-8

XXXXX

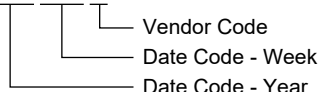

ABSOLUTE MAXIMUM RATINGS

- Supply Voltage..... 6V
- Signal Input Terminals, Voltage
..... (-V_S) - 0.3V to (+V_S) + 0.3V
- Signal Input Terminals, Current ±10mA
- Output Short-Circuit..... Continuous
- Junction Temperature..... +150°C
- Storage Temperature Range -65°C to +150°C
- Lead Temperature (Soldering, 10s)..... +260°C
- ESD Susceptibility
- HBM..... 8000V
- MM..... 400V
- CDM 1000V

RECOMMENDED OPERATING CONDITIONS

- Supply Voltage Range 2.2V to 5.5V
- Operating Temperature Range -40°C to +125°C

OVERSTRESS CAUTION

Stresses beyond those listed in Absolute Maximum Ratings may cause permanent damage to the device. Exposure to absolute maximum rating conditions for extended periods may affect reliability. Functional operation of the device at any conditions beyond those indicated in the Recommended Operating Conditions section is not implied.

ESD SENSITIVITY CAUTION

This integrated circuit can be damaged if ESD protections are not considered carefully. SGMICRO recommends that all integrated circuits be handled with appropriate precautions. Failure to observe proper handling and installation procedures can cause damage. ESD damage can range from subtle performance degradation to complete device failure. Precision integrated circuits may be more susceptible to damage because even small parametric changes could cause the device not to meet the published specifications.

DISCLAIMER

SG Micro Corp reserves the right to make any change in circuit design, or specifications without prior notice.

PIN CONFIGURATIONS

SGM8965-1 (TOP VIEW)

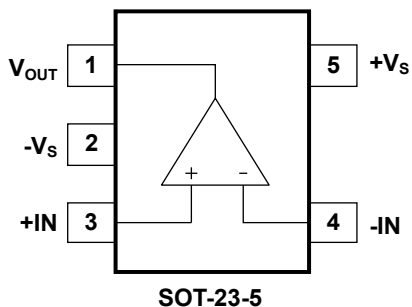

SGM8965-1 (TOP VIEW)

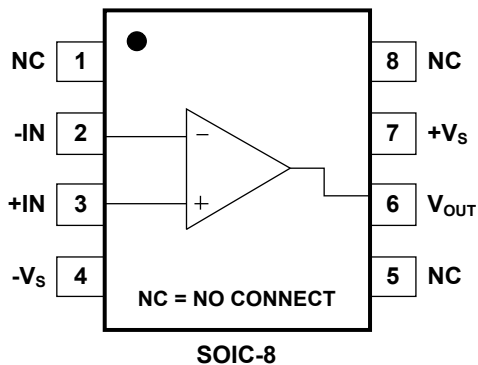

SGM8965-2 (TOP VIEW)

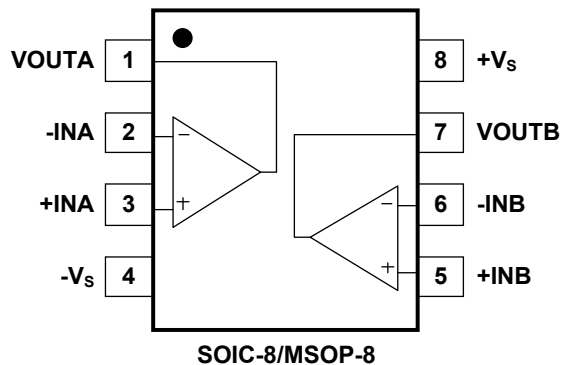

ELECTRICAL CHARACTERISTICS

($T_A = +25^\circ\text{C}$, $V_S = 2.2\text{V}$ to 5.5V , $V_{CM} = V_S/2$, $V_{OUT} = V_S/2$ and $R_L = 10\text{k}\Omega$ connected to $V_S/2$, unless otherwise noted.)

PARAMETER	SYMBOL	CONDITIONS	MIN	TYP	MAX	UNIT
Input Characteristics						
Input Offset Voltage	V_{OS}			80	250	μV
Input Offset Voltage Drift	$\Delta V_{OS}/\Delta T$	$-40^\circ\text{C} \leq T_A \leq +125^\circ\text{C}$		1.2		$\mu\text{V}/^\circ\text{C}$
Power Supply Rejection Ratio	PSRR	$V_S = 2.2\text{V}$ to 5.5V , $-40^\circ\text{C} \leq T_A \leq +125^\circ\text{C}$		6	90	$\mu\text{V}/\text{V}$
Input Bias Current	I_B			0.5		pA
Input Common Mode Voltage Range	V_{CM}		$(-V_S) - 0.1$		$(+V_S) + 0.1$	V
Common Mode Rejection Ratio	CMRR	$(-V_S) - 0.1\text{V} \leq V_{CM} \leq (+V_S) + 0.1\text{V}$, $V_S = 5.5\text{V}$, $-40^\circ\text{C} \leq T_A \leq +125^\circ\text{C}$	82	100		dB
Open-Loop Voltage Gain	A_{OL}	$R_L = 10\text{k}\Omega$, $(-V_S) + 0.1\text{V} < V_O < (+V_S) - 0.1\text{V}$, $-40^\circ\text{C} \leq T_A \leq +125^\circ\text{C}$	94	115		dB
		$R_L = 600\Omega$, $(-V_S) + 0.2\text{V} < V_O < (+V_S) - 0.2\text{V}$ $-40^\circ\text{C} \leq T_A \leq +125^\circ\text{C}$	94	105		
		$-40^\circ\text{C} \leq T_A \leq +125^\circ\text{C}$	90			
Output Characteristics						
Output Voltage Swing from Rail		$R_L = 10\text{k}\Omega$, $V_S = 5.5\text{V}$, $-40^\circ\text{C} \leq T_A \leq +125^\circ\text{C}$		8	22	mV
Short-Circuit Current	I_{SC}	$V_S = 5\text{V}$		70		mA
Open-Loop Output Impedance		$f = 1\text{MHz}$, $I_O = 0$		26		Ω
Power Supply						
Operating Voltage Range	V_S		2.2		5.5	V
Quiescent Current/Amplifier	I_Q	$I_O = 0$		5.3	6.6	mA
		$-40^\circ\text{C} \leq T_A \leq +125^\circ\text{C}$			6.9	
Dynamic Performance						
Gain-Bandwidth Product	GBP	$V_S = 5\text{V}$		50		MHz
Slew Rate	SR	$V_S = 5\text{V}$, $G = +1$		30		$\text{V}/\mu\text{s}$
Settling Time to 0.1%	t_s	$V_S = 5\text{V}$, 4V Step, $G = +4$		220		ns
Settling Time to 0.01%		$V_S = 5\text{V}$, 4V Step, $G = +4$		300		ns
Overload Recovery Time		$V_S = 5\text{V}$, $V_{IN} \times \text{Gain} > V_S$		< 0.1		μs
Total Harmonic Distortion + Noise ⁽¹⁾	THD+N	$V_S = 5\text{V}$, $R_L = 600\Omega$, $V_O = 4V_{PP}$, $G = +1$, $f = 1\text{kHz}$		0.00015		$\%$
Noise Performance						
Input Voltage Noise		$f = 0.1\text{Hz}$ to 10Hz		5		μV_{PP}
Input Voltage Noise Density	e_n	$f = 100\text{kHz}$		4.5		$\text{nV}/\sqrt{\text{Hz}}$
Input Current Noise Density	i_n	$f = 10\text{kHz}$		125		$\text{fA}/\sqrt{\text{Hz}}$

NOTE: 1. 3rd-order filter; bandwidth 80kHz at -3dB.

TYPICAL PERFORMANCE CHARACTERISTICS

At $T_A = +25^\circ\text{C}$, $V_S = 5\text{V}$ and $C_L = 0\text{pF}$, unless otherwise noted.

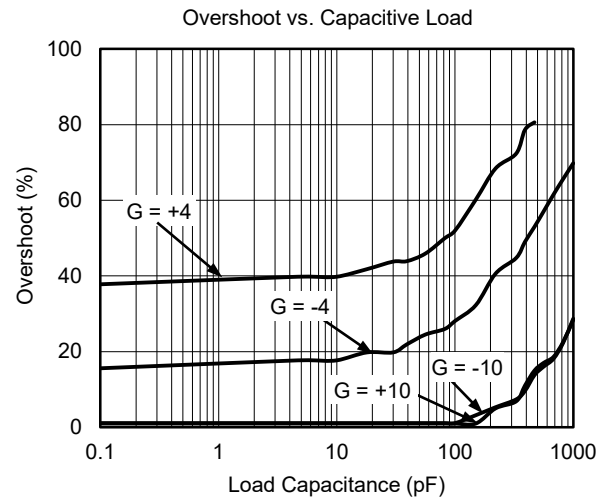
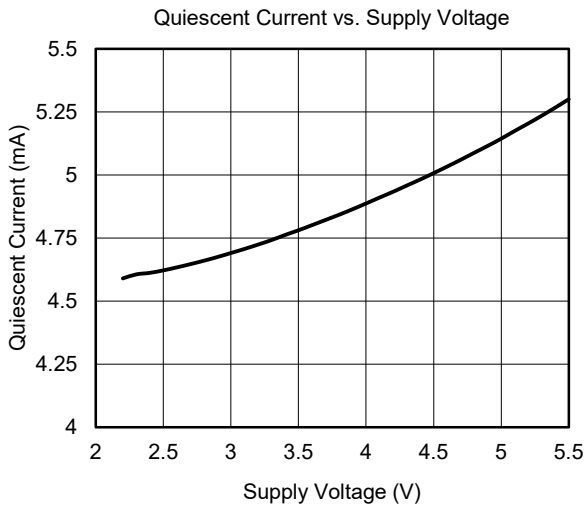
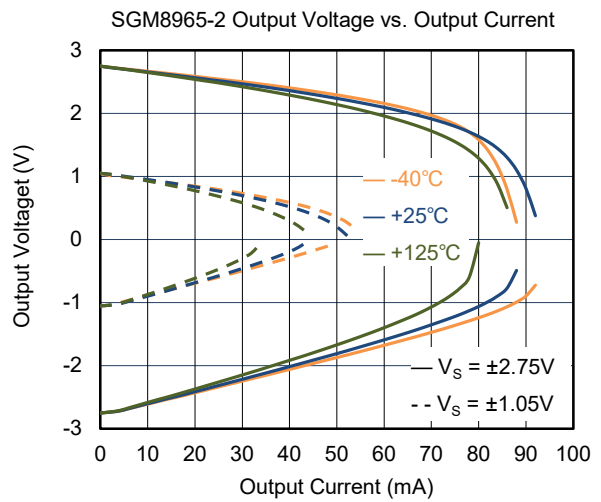
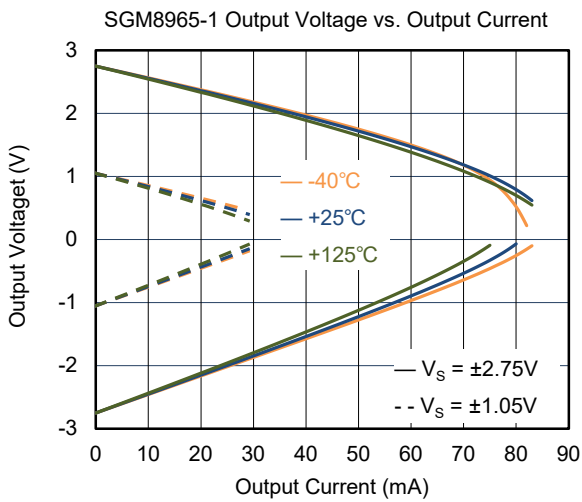
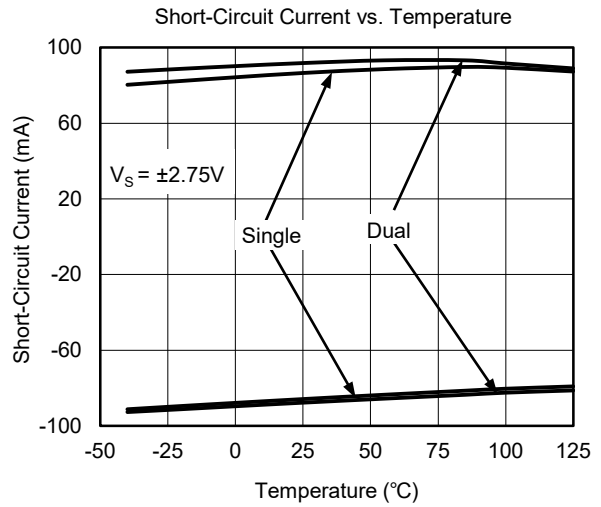
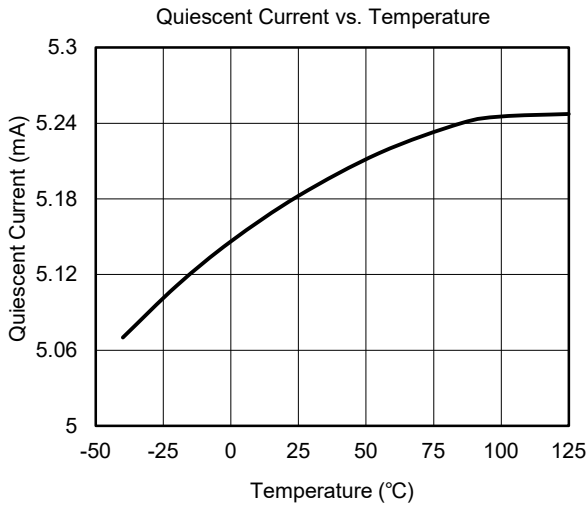

TYPICAL PERFORMANCE CHARACTERISTICS (continued)

At $T_A = +25^\circ\text{C}$, $V_S = 5\text{V}$ and $C_L = 0\text{pF}$, unless otherwise noted.

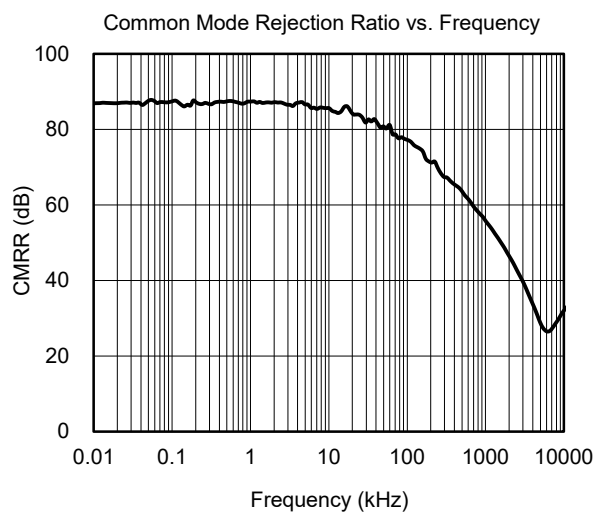
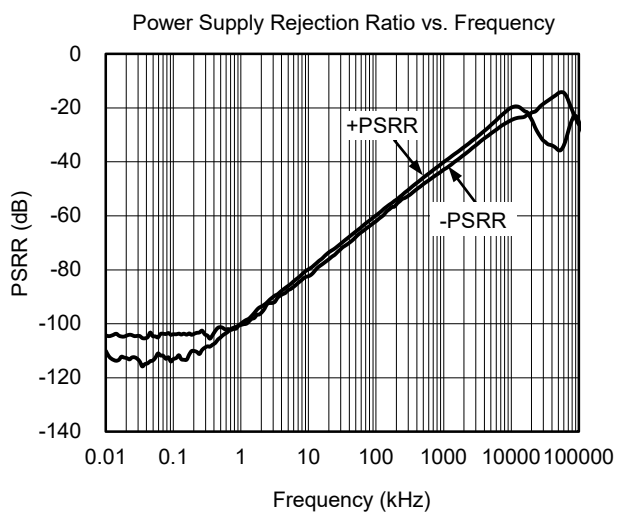
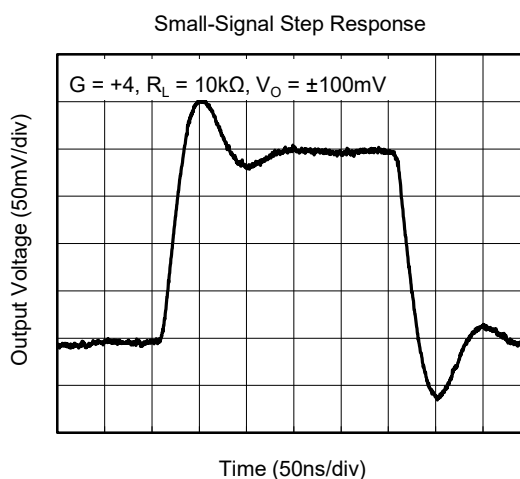
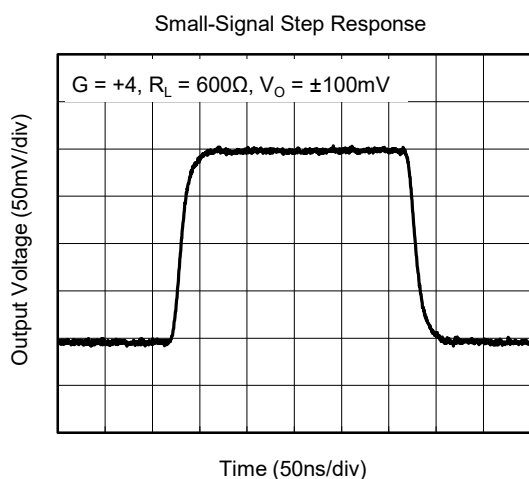
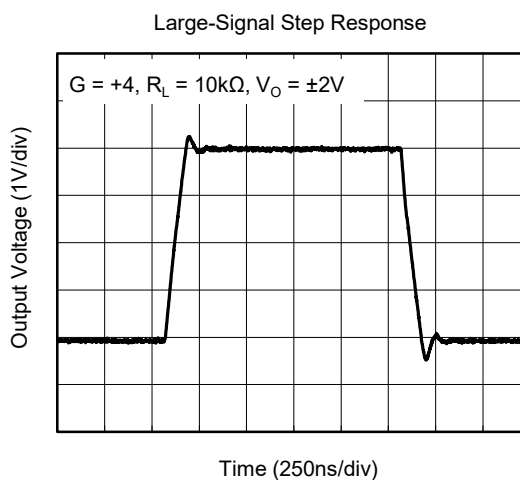
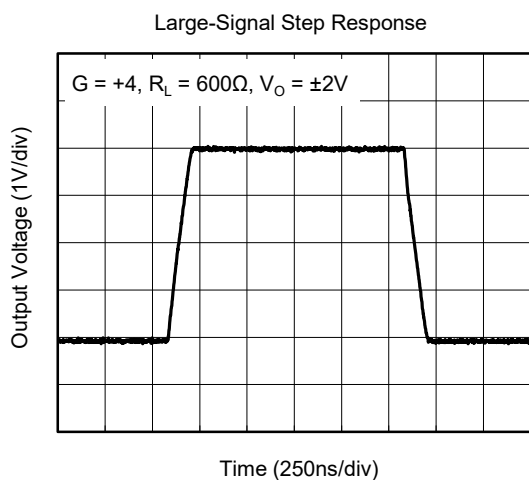

TYPICAL PERFORMANCE CHARACTERISTICS (continued)

At $T_A = +25^\circ\text{C}$, $V_S = 5\text{V}$ and $C_L = 0\text{pF}$, unless otherwise noted.

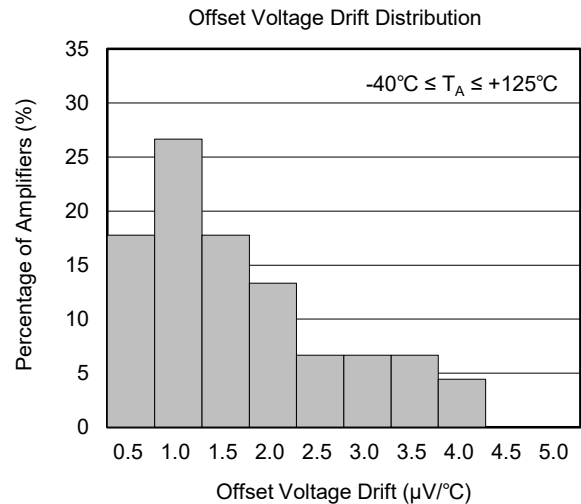
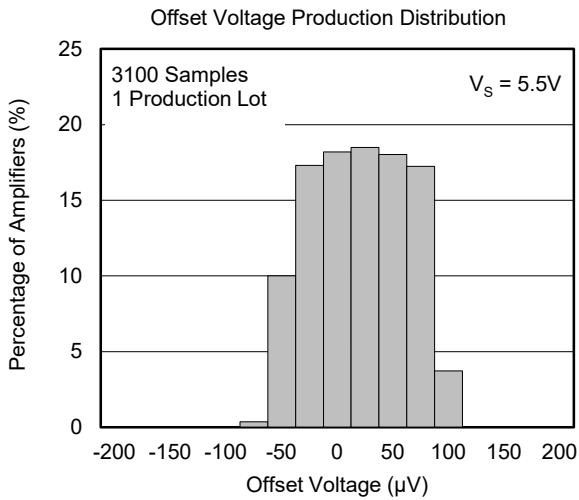
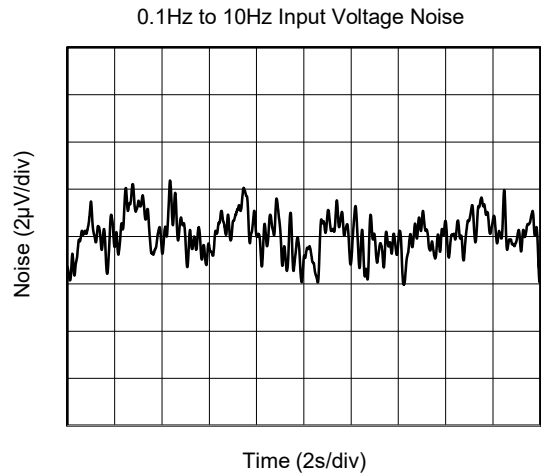
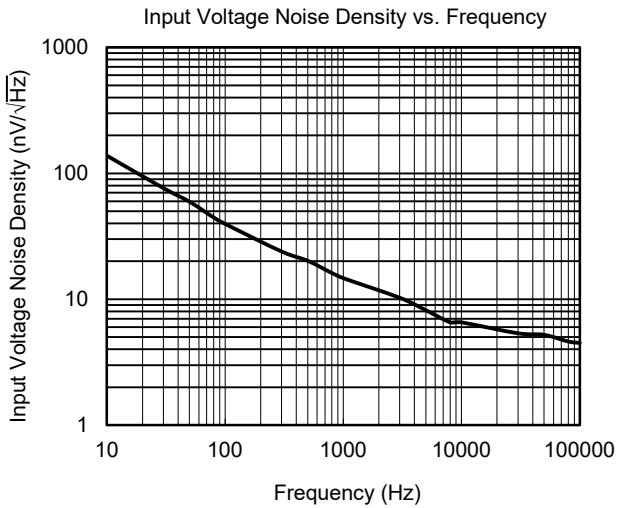
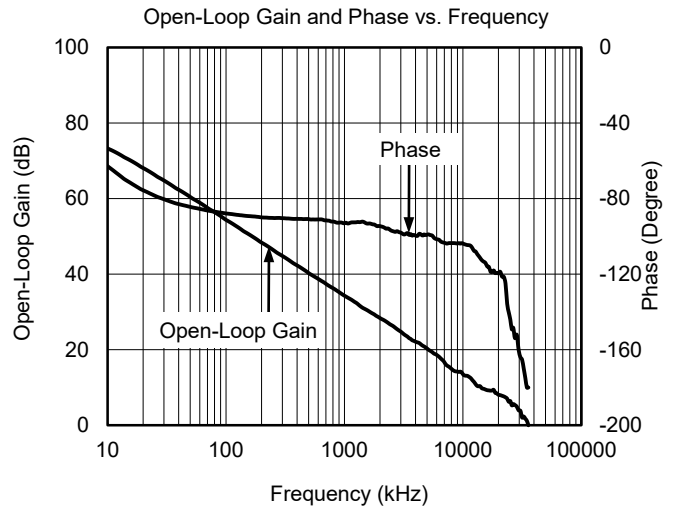
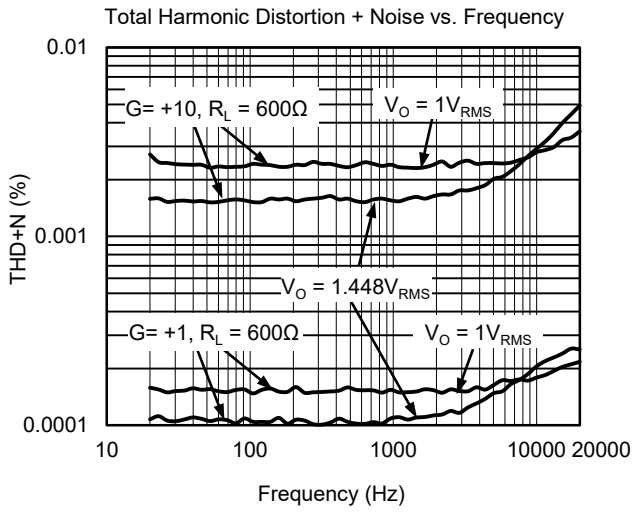

APPLICATION INFORMATION

Basic Amplifier Configurations

As with other single supply operational amplifiers, the SGM8965-1/2 may be operated with either a single supply or dual supplies. A typical dual supply connection is shown in Figure 1, which is accompanied by a single supply connection. The SGM8965-1 is configured as a basic inverting amplifier with a gain of -10V/V. The dual supply connection has an output voltage centered on zero, while the single supply

connection has an output centered on the common mode voltage V_{CM} . For the circuit shown, this voltage is 1.5V, but may be any value within the input common mode voltage range. The SGM8965-1 V_{CM} range extends 100mV beyond the power-supply rails.

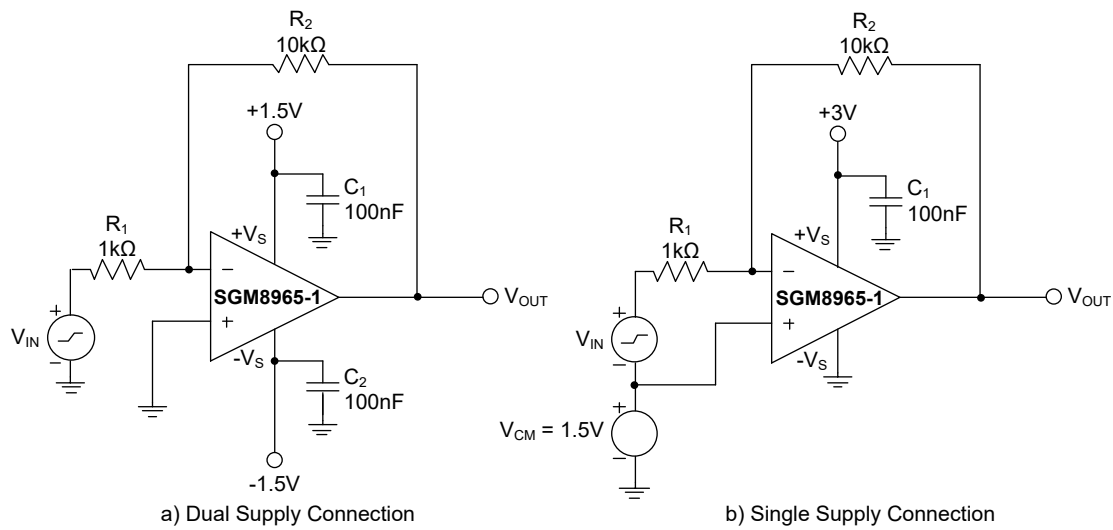

Figure 1. Basic Circuit Connections

REVISION HISTORY

NOTE: Page numbers for previous revisions may differ from page numbers in the current version.

Changes from Original (DECEMBER 2016) to REV.A	Page
Changed from product preview to production data.....	All

PACKAGE INFORMATION

PACKAGE OUTLINE DIMENSIONS

SOT-23-5

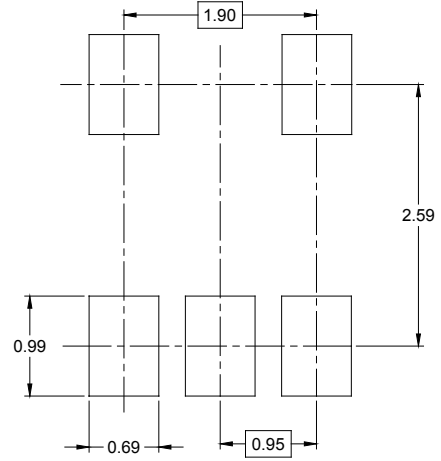

RECOMMENDED LAND PATTERN (Unit: mm)



Symbol	Dimensions In Millimeters		Dimensions In Inches	
	MIN	MAX	MIN	MAX
A	1.050	1.250	0.041	0.049
A1	0.000	0.100	0.000	0.004
A2	1.050	1.150	0.041	0.045
b	0.300	0.500	0.012	0.020
c	0.100	0.200	0.004	0.008
D	2.820	3.020	0.111	0.119
E	1.500	1.700	0.059	0.067
E1	2.650	2.950	0.104	0.116
e	0.950 BSC		0.037 BSC	
e1	1.900 BSC		0.075 BSC	
L	0.300	0.600	0.012	0.024
θ	0°	8°	0°	8°

PACKAGE OUTLINE DIMENSIONS

SOIC-8

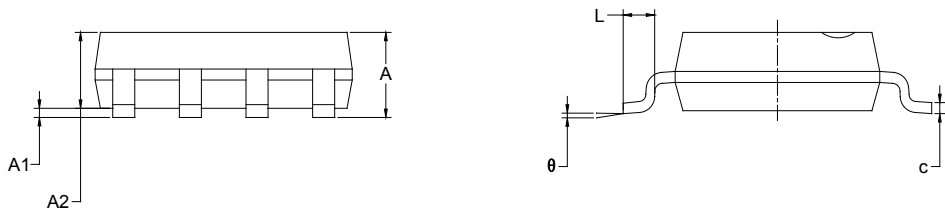
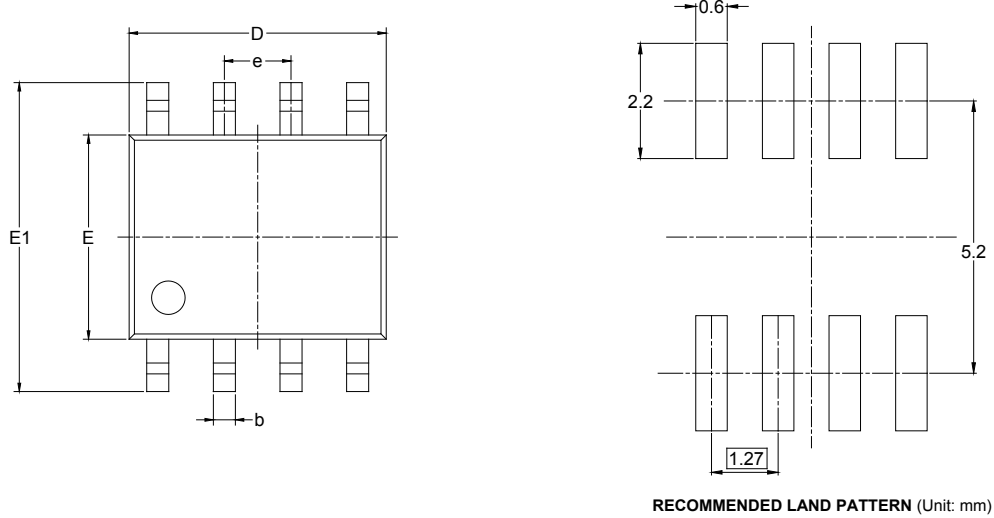

Symbol	Dimensions In Millimeters		Dimensions In Inches	
	MIN	MAX	MIN	MAX
A	1.350	1.750	0.053	0.069
A1	0.100	0.250	0.004	0.010
A2	1.350	1.550	0.053	0.061
b	0.330	0.510	0.013	0.020
c	0.170	0.250	0.006	0.010
D	4.700	5.100	0.185	0.200
E	3.800	4.000	0.150	0.157
E1	5.800	6.200	0.228	0.244
e	1.27 BSC		0.050 BSC	
L	0.400	1.270	0.016	0.050
θ	0°	8°	0°	8°

PACKAGE OUTLINE DIMENSIONS

MSOP-8



RECOMMENDED LAND PATTERN (Unit: mm)

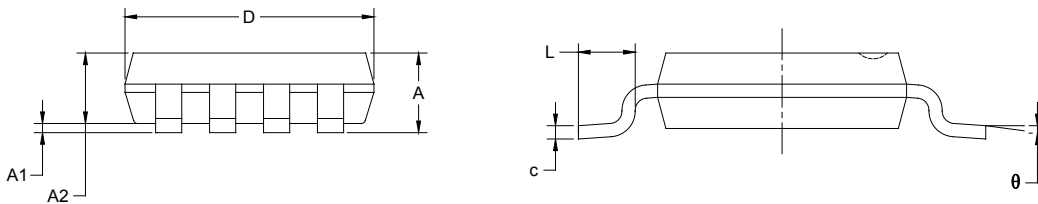

Symbol	Dimensions In Millimeters		Dimensions In Inches	
	MIN	MAX	MIN	MAX
A	0.820	1.100	0.032	0.043
A1	0.020	0.150	0.001	0.006
A2	0.750	0.950	0.030	0.037
b	0.250	0.380	0.010	0.015
c	0.090	0.230	0.004	0.009
D	2.900	3.100	0.114	0.122
E	2.900	3.100	0.114	0.122
E1	4.750	5.050	0.187	0.199
e	0.650 BSC		0.026 BSC	
L	0.400	0.800	0.016	0.031
θ	0°	6°	0°	6°

TAPE AND REEL INFORMATION

REEL DIMENSIONS



TAPE DIMENSIONS



NOTE: The picture is only for reference. Please make the object as the standard.

KEY PARAMETER LIST OF TAPE AND REEL

Package Type	Reel Diameter	Reel Width W1 (mm)	A0 (mm)	B0 (mm)	K0 (mm)	P0 (mm)	P1 (mm)	P2 (mm)	W (mm)	Pin1 Quadrant
SOT-23-5	7"	9.5	3.20	3.20	1.40	4.0	4.0	2.0	8.0	Q3
SOIC-8	13"	12.4	6.40	5.40	2.10	4.0	8.0	2.0	12.0	Q1
MSOP-8	13"	12.4	5.20	3.30	1.50	4.0	8.0	2.0	12.0	Q1

DD0001

PACKAGE INFORMATION

CARTON BOX DIMENSIONS



NOTE: The picture is only for reference. Please make the object as the standard.

KEY PARAMETER LIST OF CARTON BOX

Reel Type	Length (mm)	Width (mm)	Height (mm)	Pizza/Carton
7" (Option)	368	227	224	8
7"	442	410	224	18
13"	386	280	370	5

DD0002