

SGM8276-1/SGM8276-2/SGM8276-4

Low Noise, High Precision, High Voltage, Rail-to-Rail I/O Operational Amplifiers

GENERAL DESCRIPTION

The SGM8276-1 (single), SGM8276-2 (dual) and SGM8276-4 (quad) are low noise, high precision, high voltage operational amplifiers that are designed to offer a wide input common mode voltage range and output voltage swing. These devices can operate from $\pm 1.65\text{V}$ to $\pm 18\text{V}$ dual power supplies or from 3.3V to 36V single supply.

The devices feature low noise, high slew rate, low input bias and offset current, low offset voltage and low offset voltage temperature coefficient.

The single SGM8276-1 is available in a Green SOT-23-5 package. The dual SGM8276-2 is available in a Green SOIC-8 package. The quad SGM8276-4 is available in a Green SOIC-14 package. The SGM8276-1/2/4 are specified over the extended -40°C to $+125^{\circ}\text{C}$ temperature range.

FEATURES

- **Wide Input Common Mode and Differential Voltage Ranges**
- **Low Input Bias and Offset Current**
- **Output Short-Circuit Protection**
- **Rail-to-Rail Input and Output**
- **High Input Impedance**
- **Low Offset Voltage: 0.3mV (TYP), 1.5mV (MAX)**
- **Low Noise: $10\text{nV}/\sqrt{\text{Hz}}$ at 1kHz**
- **Gain-Bandwidth Product: 10MHz**
- **High Slew Rate: $8\text{V}/\mu\text{s}$**
- **-40°C to $+125^{\circ}\text{C}$ Operating Temperature Range**
- **Small Packaging:**
 - SGM8276-1 Available in a Green SOT-23-5 Package
 - SGM8276-2 Available in a Green SOIC-8 Package
 - SGM8276-4 Available in a Green SOIC-14 Package

APPLICATIONS

High Impedance Sensors
Photodiode Amplifiers
High End, Professional Audio
DAC Output Amplifiers
Medicals

PACKAGE/ORDERING INFORMATION

MODEL	PACKAGE DESCRIPTION	SPECIFIED TEMPERATURE RANGE	ORDERING NUMBER	PACKAGE MARKING	PACKING OPTION
SGM8276-1	SOT-23-5	-40°C to +125°C	SGM8276-1AXN5G/TR	GMAXX	Tape and Reel, 3000
	SOT-23-5	-40°C to +125°C	SGM8276-1BXN5G/TR	GMBXX	Tape and Reel, 3000
SGM8276-2	SOIC-8	-40°C to +125°C	SGM8276-2XS8G/TR	SGM 82762XS8 XXXXX	Tape and Reel, 4000
SGM8276-4	SOIC-14	-40°C to +125°C	SGM8276-4XS14G/TR	SGM82764XS14 XXXXX	Tape and Reel, 2500

MARKING INFORMATION

NOTE: XX = Date Code. XXXXX = Date Code and Vendor Code.

SOT-23-5

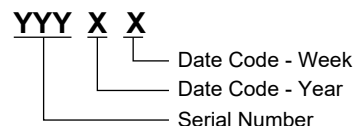

SOIC-8/SOIC-14

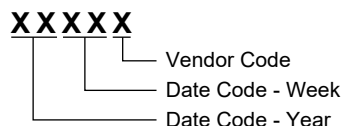

Green (RoHS & HSF): SG Micro Corp defines "Green" to mean Pb-Free (RoHS compatible) and free of halogen substances. If you have additional comments or questions, please contact your SGMICRO representative directly.

ABSOLUTE MAXIMUM RATINGS

Supply Voltage, +V _s to -V _s	40V
Input/Output Voltage Range..... (-V _s) - 0.3V to (+V _s) + 0.3V	
Junction Temperature	+150°C
Storage Temperature Range.....	-65°C to +150°C
Lead Temperature (Soldering, 10s)	+260°C
ESD Susceptibility	
HBM (SGM8276-1)	5000V
HBM (SGM8276-2/4)	6000V
MM (SGM8276-1)	200V
MM (SGM8276-2/4)	300V
CDM	1000V

RECOMMENDED OPERATING CONDITIONS

Operating Temperature Range	-40°C to +125°C
-----------------------------------	-----------------

NOTE:

1. Proper power supply sequencing is recommended for the CMOS device. Always sequence V_s on first, followed by the inputs and outputs.

OVERSTRESS CAUTION

Stresses beyond those listed in Absolute Maximum Ratings may cause permanent damage to the device. Exposure to absolute maximum rating conditions for extended periods may affect reliability. Functional operation of the device at any conditions beyond those indicated in the Recommended Operating Conditions section is not implied.

ESD SENSITIVITY CAUTION

This integrated circuit can be damaged by ESD if you don't pay attention to ESD protection. SGMICRO recommends that all integrated circuits be handled with appropriate precautions. Failure to observe proper handling and installation procedures can cause damage. ESD damage can range from subtle performance degradation to complete device failure. Precision integrated circuits may be more susceptible to damage because very small parametric changes could cause the device not to meet its published specifications.

DISCLAIMER

SG Micro Corp reserves the right to make any change in circuit design, or specifications without prior notice.

PIN CONFIGURATIONS

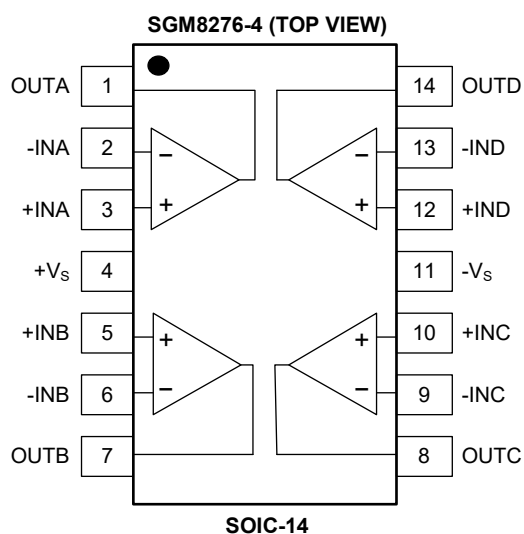
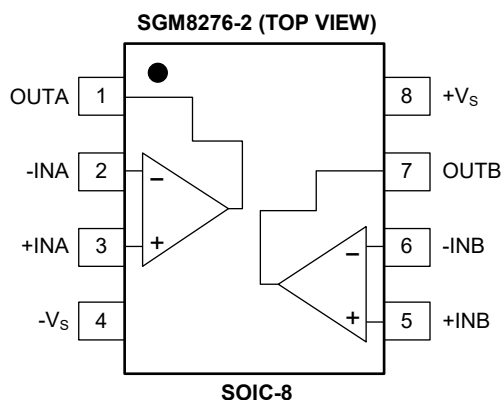
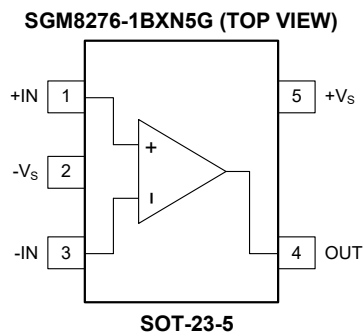
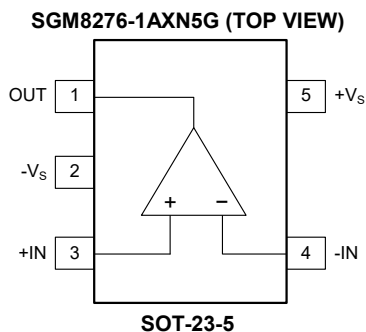

ELECTRICAL CHARACTERISTICS

(At $T_A = +25^\circ\text{C}$, $V_S = \pm 1.65\text{V}$ to $\pm 18\text{V}$ and $R_L = 2\text{k}\Omega$ connected to 0V , Full = -40°C to $+125^\circ\text{C}$, unless otherwise noted.)

PARAMETER	SYMBOL	CONDITIONS	TEMP	MIN	TYP	MAX	UNITS
INPUT CHARACTERISTICS							
Input Offset Voltage	V_{OS}	$V_S = \pm 2.5\text{V}$ to $\pm 18\text{V}$, $V_{CM} = 0\text{V}$	+25°C		0.3	1.5	mV
			Full			1.8	
Input Offset Voltage Drift	$\Delta V_{OS}/\Delta T$		Full		1		$\mu\text{V}/^\circ\text{C}$
Input Bias Current	I_B	$V_{CM} = 0\text{V}$	+25°C		± 50	± 300	pA
Input Offset Current	I_{OS}	$V_{CM} = 0\text{V}$	+25°C		± 10	± 300	pA
Maximum Differential Input Voltage	$ V_{ID} $		Full			$(+V_S) - (-V_S)$	V
Maximum Differential Input Bias Current	$ I_{ID} $	$V_S = \pm 18\text{V}$, $V_{ID} = \pm 18\text{V}$	+25°C		2	3	μA
			Full			4	
Input Common Mode Voltage Range	V_{CM}		Full	$(-V_S) - 0.1$		$(+V_S) + 0.1$	V
Common Mode Rejection Ratio	CMRR	$V_S = \pm 18\text{V}$, $(-V_S) - 0.1\text{V} < V_{CM} < (+V_S) - 2\text{V}$	+25°C	95	110		dB
			Full	92			
		$V_S = \pm 18\text{V}$, $(-V_S) - 0.1\text{V} < V_{CM} < (+V_S) + 0.1\text{V}$	+25°C	70	80		
			Full	64			
Open-Loop Voltage Gain	A_{OL}	$(-V_S) + 0.2\text{V} < V_{OUT} < (+V_S) - 0.2\text{V}$, $R_L = 10\text{k}\Omega$	+25°C	98	120		dB
			Full	95			
		$(-V_S) + 0.5\text{V} < V_{OUT} < (+V_S) - 0.5\text{V}$, $R_L = 2\text{k}\Omega$	+25°C	96	120		
			Full	75			
INPUT IMPEDANCE							
Differential	Z_{DIFF}	$V_S = \pm 18\text{V}$	+25°C		$10^{11} \parallel 6$		$\Omega \parallel \text{pF}$
Common Mode	Z_{CM}	$V_S = \pm 18\text{V}$	+25°C		$10^{12} \parallel 6$		$\Omega \parallel \text{pF}$
OUTPUT CHARACTERISTICS							
Output Voltage Swing from Rail	V_{OUT}	$V_S = \pm 18\text{V}$, $R_L = 10\text{k}\Omega$	+25°C		60	90	mV
			Full			115	
		$V_S = \pm 18\text{V}$, $R_L = 2\text{k}\Omega$	+25°C		300	420	
			Full			560	
Output Short-Circuit Current	I_{SC}	$V_S = \pm 18\text{V}$	+25°C	± 40	± 55		mA
POWER SUPPLY							
Operating Voltage Range	V_S		Full	3.3		36	V
Quiescent Current/Amplifier	I_Q	$I_{OUT} = 0$	+25°C		1.4	1.85	mA
			Full			2.1	
Power Supply Rejection Ratio	PSRR	$V_S = 5\text{V}$ to 36V	+25°C	100	120		dB
			Full	97			

ELECTRICAL CHARACTERISTICS (continued)

(At $T_A = +25^\circ\text{C}$, $V_S = \pm 1.65\text{V}$ to $\pm 18\text{V}$ and $R_L = 2\text{k}\Omega$ connected to 0V , Full = -40°C to $+125^\circ\text{C}$, unless otherwise noted.)

PARAMETER	SYMBOL	CONDITIONS	TEMP	MIN	TYP	MAX	UNITS
DYNAMIC PERFORMANCE							
Gain-Bandwidth Product	GBP	$C_L = 50\text{pF}$	$+25^\circ\text{C}$		10		MHz
Phase Margin	ϕ_o	$V_S = \pm 18\text{V}$, $C_L = 50\text{pF}$	$+25^\circ\text{C}$		45		$^\circ$
Slew Rate	SR	$V_S = \pm 2.5\text{V}$ to $\pm 18\text{V}$, $G = +1$	$+25^\circ\text{C}$		8		$\text{V}/\mu\text{s}$
Overload Recovery Time	ORT	$V_{IN} \times G > V_S$	$+25^\circ\text{C}$		1		μs
Total Harmonic Distortion + Noise	THD+N	$V_{OUT} = 2V_{P-P}$, $f = 1\text{kHz}$, $G = +1$, $R_L = 600\Omega$	$+25^\circ\text{C}$		0.005		%
		$V_{OUT} = 2V_{P-P}$, $f = 1\text{kHz}$, $G = +1$, $R_L = 2\text{k}\Omega$	$+25^\circ\text{C}$		0.0005		
NOISE							
Input Voltage Noise		$f = 0.1\text{Hz}$ to 10Hz	$+25^\circ\text{C}$		3		μV_{P-P}
Input Voltage Noise Density	e_n	$f = 10\text{Hz}$	$+25^\circ\text{C}$		80		$\text{nV}/\sqrt{\text{Hz}}$
		$f = 1\text{kHz}$	$+25^\circ\text{C}$		10		
Input Current Noise Density	i_n	$f = 1\text{kHz}$	$+25^\circ\text{C}$		500		$\text{fA}/\sqrt{\text{Hz}}$

TYPICAL PERFORMANCE CHARACTERISTICS

At $T_A = +25^\circ\text{C}$, $V_S = 36\text{V}$ and $R_L = 2\text{k}\Omega$, unless otherwise noted.

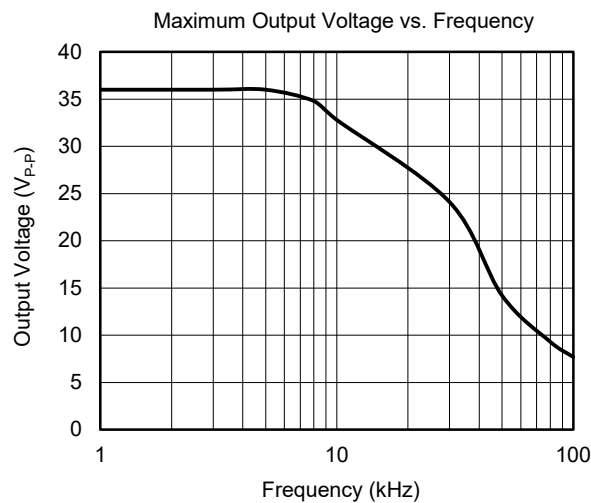
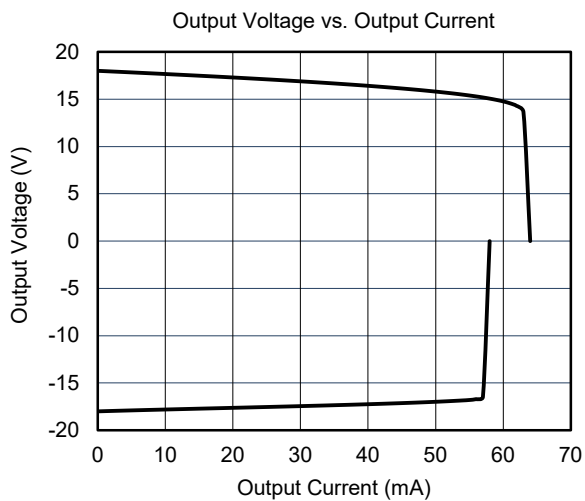
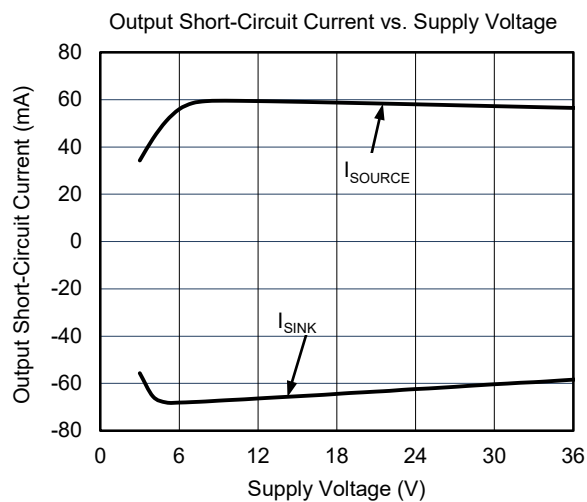
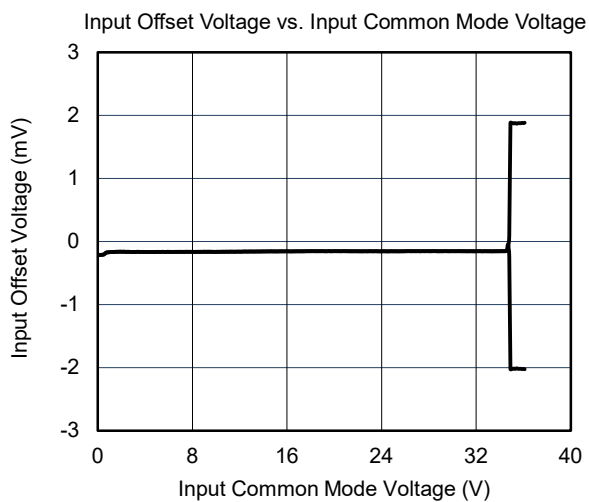
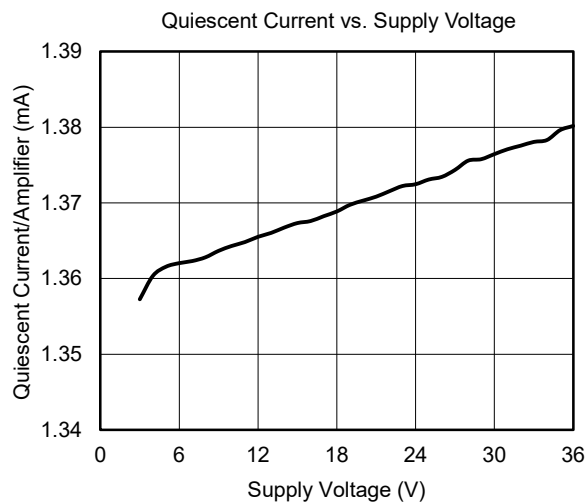
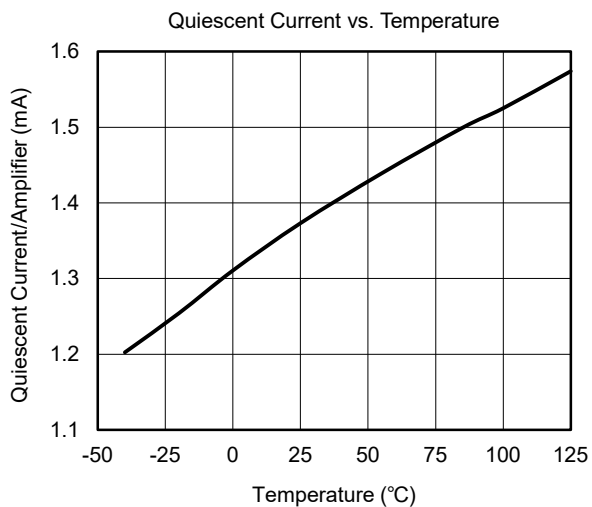

TYPICAL PERFORMANCE CHARACTERISTICS (continued)

At $T_A = +25^\circ\text{C}$, $V_S = 36\text{V}$ and $R_L = 2\text{k}\Omega$, unless otherwise noted.

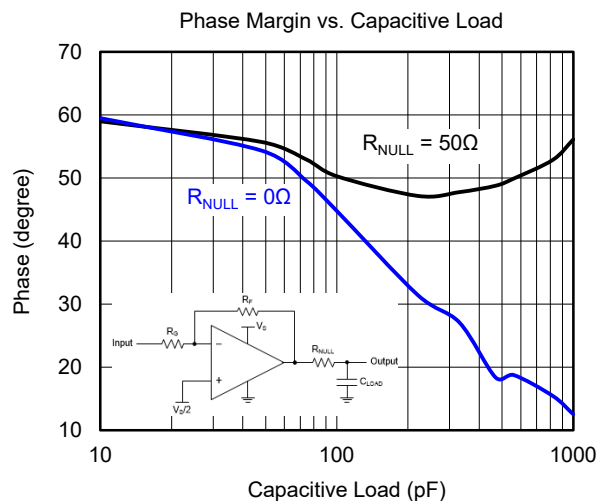
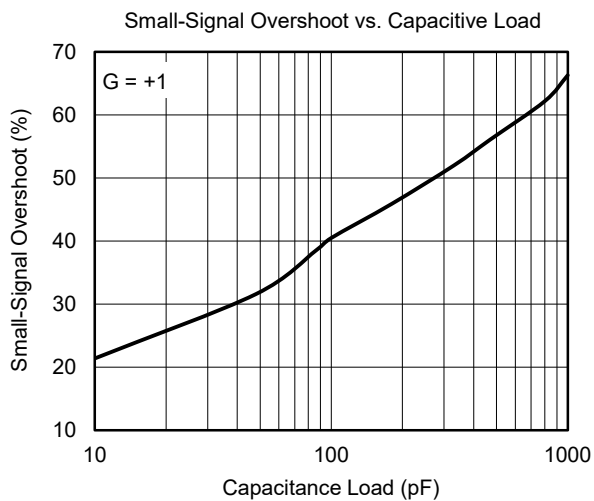
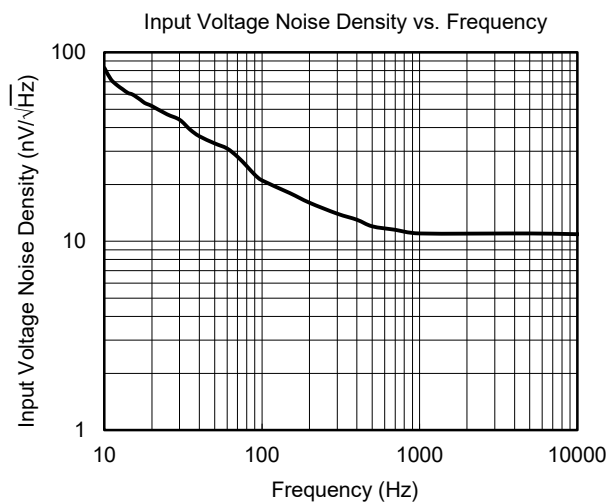
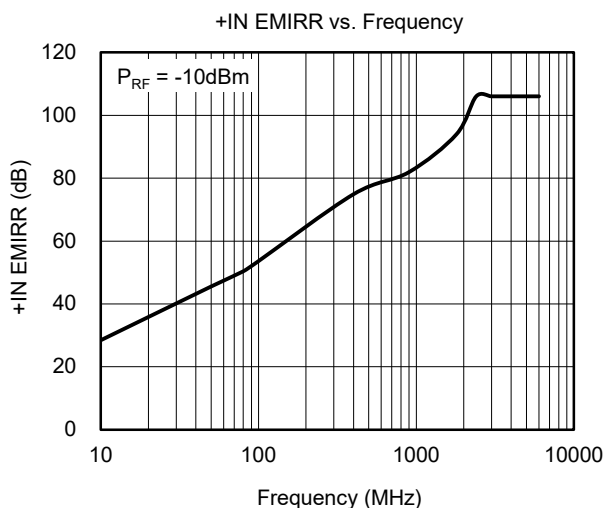
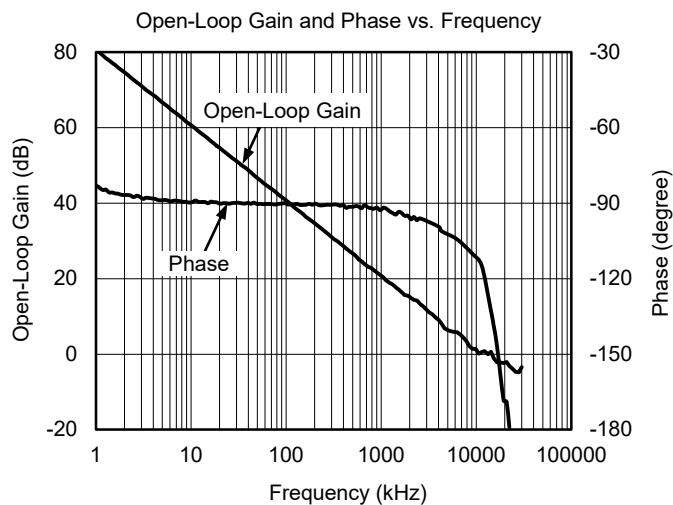
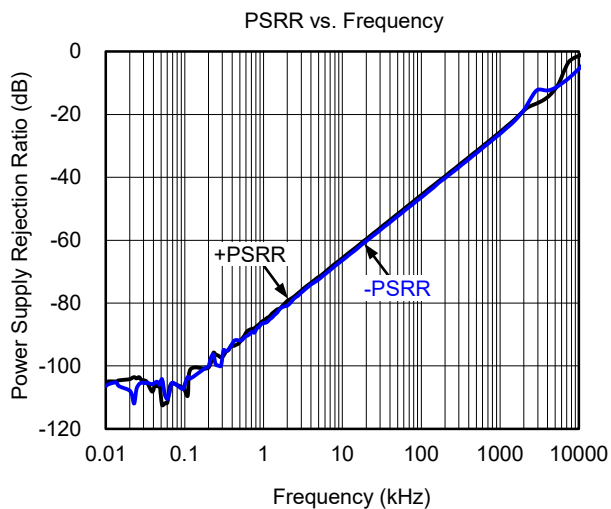

TYPICAL PERFORMANCE CHARACTERISTICS (continued)

At $T_A = +25^\circ\text{C}$, $V_S = 36\text{V}$ and $R_L = 2\text{k}\Omega$, unless otherwise noted.

Small-Signal Step Response

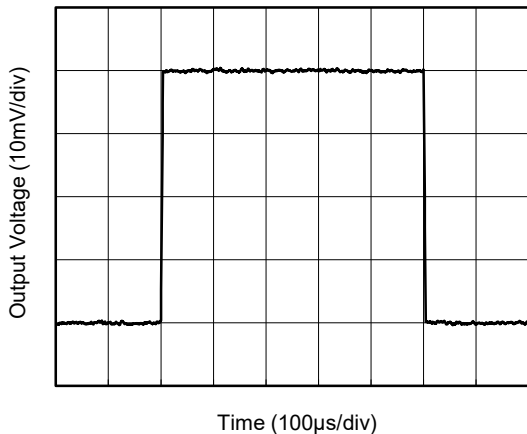

Large-Signal Step Response

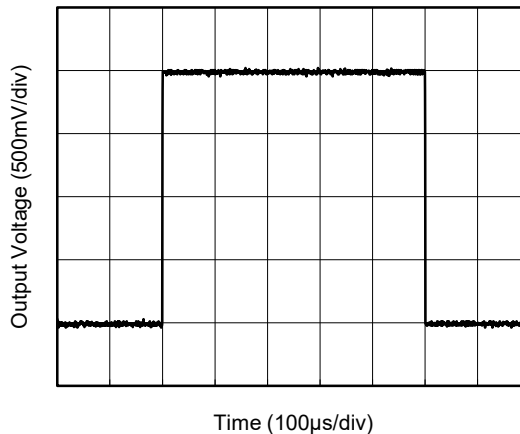

0.1Hz to 10Hz Input Voltage Noise

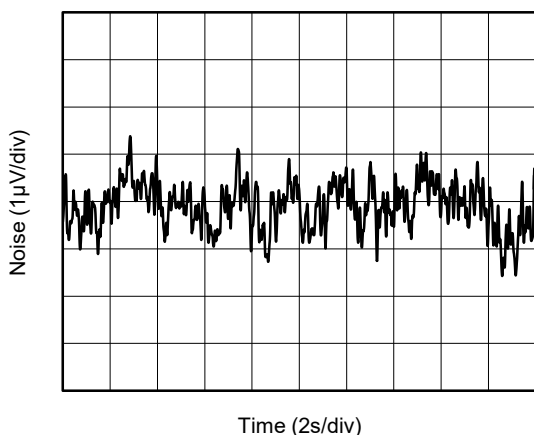

Input Offset Voltage Production Distribution

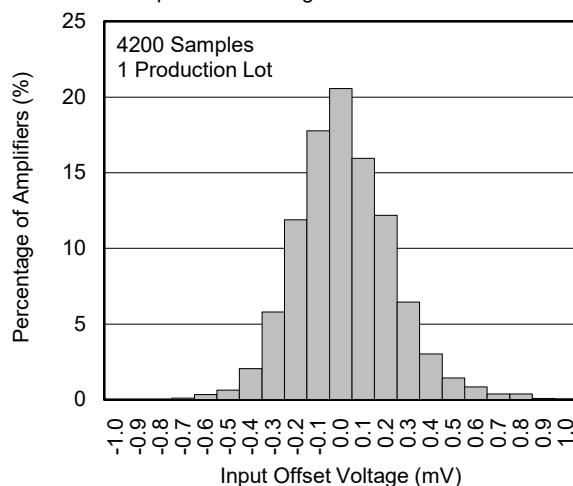

Quiescent Current Production Distribution

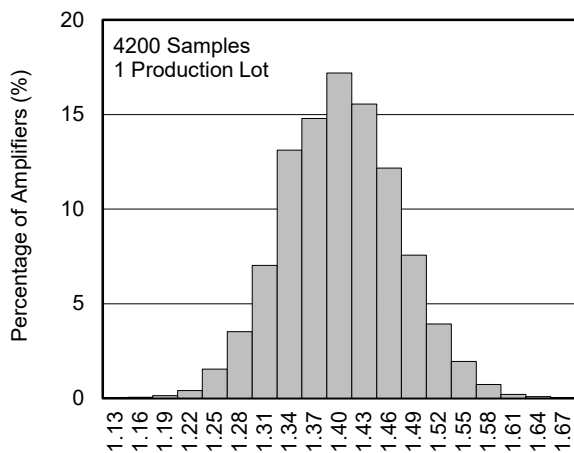

Input Offset Voltage Drift Distribution

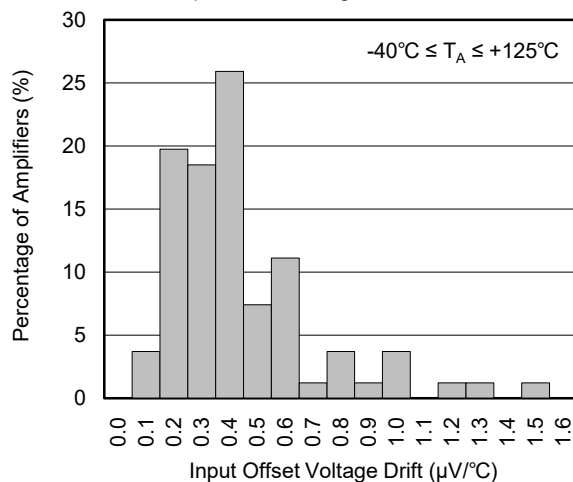

REVISION HISTORY

NOTE: Page numbers for previous revisions may differ from page numbers in the current version.

Changes from Original (DECEMBER 2018) to REV.A

Changed from product preview to production data.....All

PACKAGE INFORMATION

PACKAGE OUTLINE DIMENSIONS

SOT-23-5

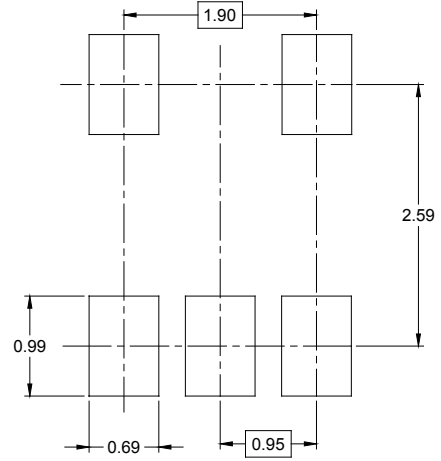
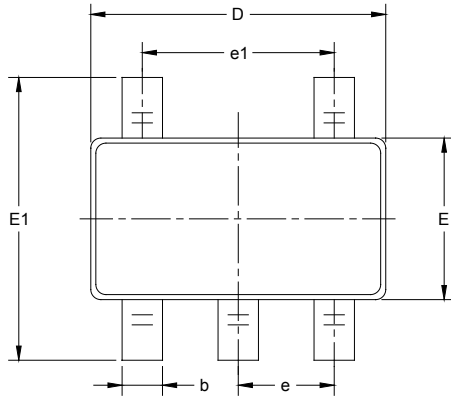

RECOMMENDED LAND PATTERN (Unit: mm)

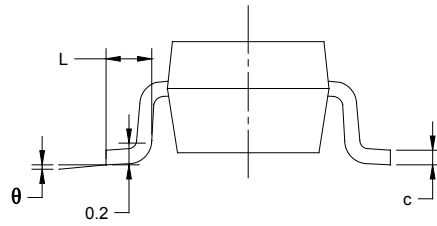
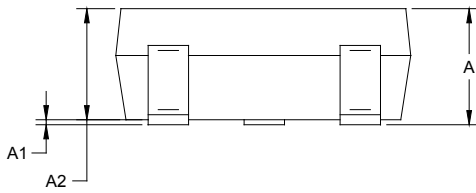

Symbol	Dimensions In Millimeters		Dimensions In Inches	
	MIN	MAX	MIN	MAX
A	1.050	1.250	0.041	0.049
A1	0.000	0.100	0.000	0.004
A2	1.050	1.150	0.041	0.045
b	0.300	0.500	0.012	0.020
c	0.100	0.200	0.004	0.008
D	2.820	3.020	0.111	0.119
E	1.500	1.700	0.059	0.067
E1	2.650	2.950	0.104	0.116
e	0.950 BSC		0.037 BSC	
e1	1.900 BSC		0.075 BSC	
L	0.300	0.600	0.012	0.024
θ	0°	8°	0°	8°

PACKAGE INFORMATION

PACKAGE OUTLINE DIMENSIONS

SOIC-8

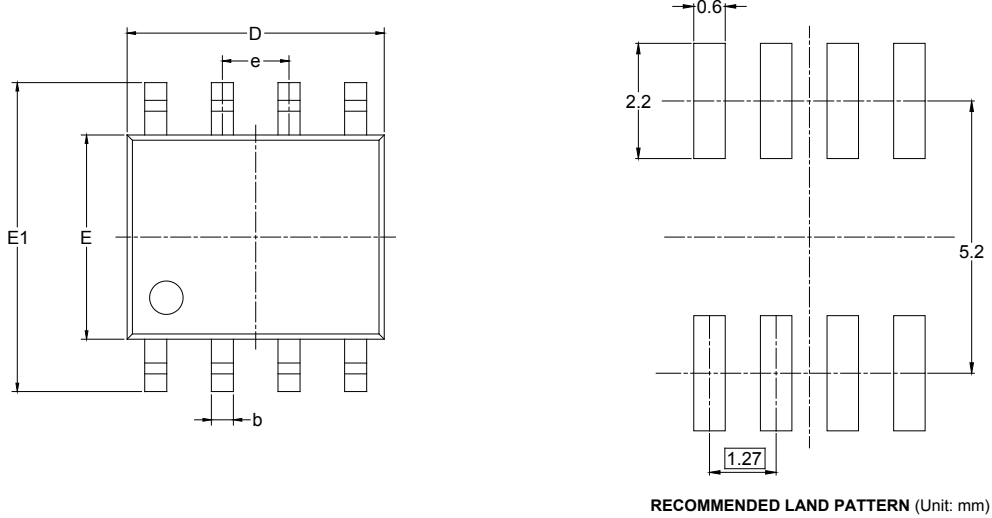

Symbol	Dimensions In Millimeters		Dimensions In Inches	
	MIN	MAX	MIN	MAX
A	1.350	1.750	0.053	0.069
A1	0.100	0.250	0.004	0.010
A2	1.350	1.550	0.053	0.061
b	0.330	0.510	0.013	0.020
c	0.170	0.250	0.006	0.010
D	4.700	5.100	0.185	0.200
E	3.800	4.000	0.150	0.157
E1	5.800	6.200	0.228	0.244
e	1.27 BSC		0.050 BSC	
L	0.400	1.270	0.016	0.050
θ	0°	8°	0°	8°

PACKAGE INFORMATION

PACKAGE OUTLINE DIMENSIONS

SOIC-14

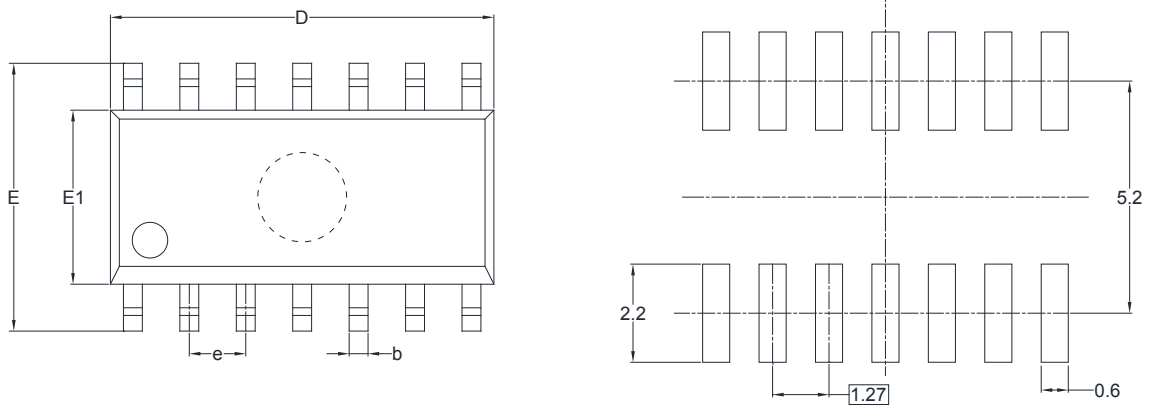

RECOMMENDED LAND PATTERN (Unit: mm)

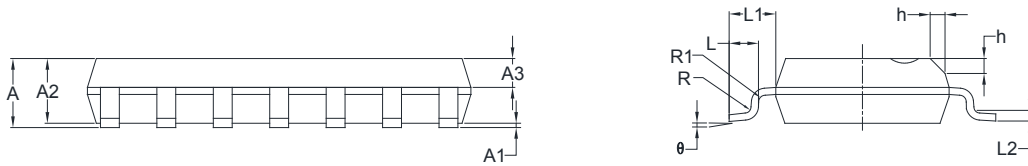

Symbol	Dimensions In Millimeters		Dimensions In Inches	
	MIN	MAX	MIN	MAX
A	1.35	1.75	0.053	0.069
A1	0.10	0.25	0.004	0.010
A2	1.25	1.65	0.049	0.065
A3	0.55	0.75	0.022	0.030
b	0.36	0.49	0.014	0.019
D	8.53	8.73	0.336	0.344
E	5.80	6.20	0.228	0.244
E1	3.80	4.00	0.150	0.157
e	1.27 BSC		0.050 BSC	
L	0.45	0.80	0.018	0.032
L1	1.04 REF		0.040 REF	
L2	0.25 BSC		0.01 BSC	
R	0.07		0.003	
R1	0.07		0.003	
h	0.30	0.50	0.012	0.020
θ	0°	8°	0°	8°

PACKAGE INFORMATION

TAPE AND REEL INFORMATION

REEL DIMENSIONS



TAPE DIMENSIONS

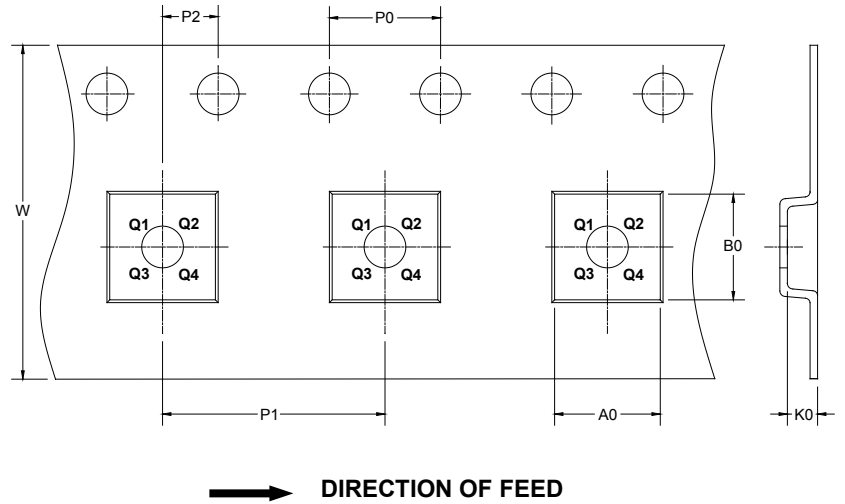

NOTE: The picture is only for reference. Please make the object as the standard.

KEY PARAMETER LIST OF TAPE AND REEL

Package Type	Reel Diameter	Reel Width W1 (mm)	A0 (mm)	B0 (mm)	K0 (mm)	P0 (mm)	P1 (mm)	P2 (mm)	W (mm)	Pin1 Quadrant
SOT-23-5	7"	9.5	3.20	3.20	1.40	4.0	4.0	2.0	8.0	Q3
SOIC-8	13"	12.4	6.40	5.40	2.10	4.0	8.0	2.0	12.0	Q1
SOIC-14	13"	16.4	6.60	9.30	2.10	4.0	8.0	2.0	16.0	Q1

DD0001

PACKAGE INFORMATION

CARTON BOX DIMENSIONS



NOTE: The picture is only for reference. Please make the object as the standard.

KEY PARAMETER LIST OF CARTON BOX

Reel Type	Length (mm)	Width (mm)	Height (mm)	Pizza/Carton
7" (Option)	368	227	224	8
7"	442	410	224	18
13"	386	280	370	5

DD0002