

GENERAL DESCRIPTION

The SGM2210 is a low quiescent current, low noise and low dropout voltage linear regulator. It is capable of supplying 300mA output current with typical dropout voltage of 240mV. The operating input voltage range is from 2.5V to 20V. The fixed output voltage range is from 1.2V to 5.0V and adjustable output voltage range is from 1.2V to 12V.

Other features include logic-controlled shutdown mode, short-circuit current limit and thermal shutdown protection. The SGM2210 has automatic discharge function to quickly discharge V_{OUT} in the disabled status.

The SGM2210 is available in a Green SOT-23-5 package. It operates over an operating temperature range of -40°C to +125°C.

FEATURES

- **Operating Input Voltage Range: 2.5V to 20V**
- **Fixed Outputs of 1.2V, 1.8V, 2.5V, 3.3V and 5.0V**
- **Adjustable Output from 1.2V to 12V**
- **300mA Output Current**
- **Output Voltage Accuracy: $\pm 1\%$ at +25°C**
- **Quiescent Current: 36 μ A (TYP)**
- **Low Dropout: 80mV (TYP) at 100mA, $V_{OUT} = 3.3V$**
- **Low Noise: 48 μ V_{RMS} (TYP) at $V_{OUT} = 3.3V$**
- **High PSRR: 100dB (TYP) at 1kHz**
- **Current Limiting and Thermal Protection**
- **With Output Automatic Discharge**
- **Stable with Small Case Size Ceramic Capacitors**
- **Shutdown Supply Current: 0.5 μ A (TYP)**
- **-40°C to +125°C Operating Temperature Range**
- **Available in a Green SOT-23-5 Package**

APPLICATIONS

Palmtop Computers
 Portable Electronics
 Industrial and Medical Equipment
 Battery-Powered Equipment

TYPICAL APPLICATION

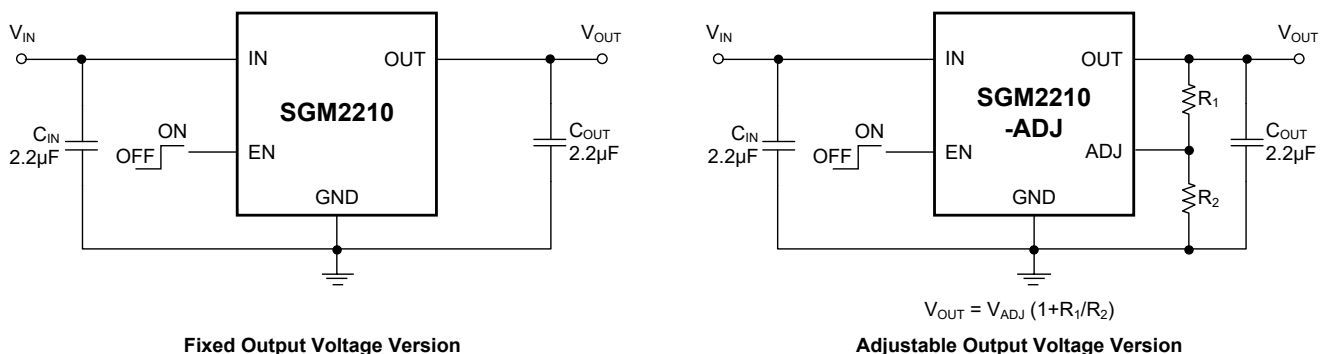
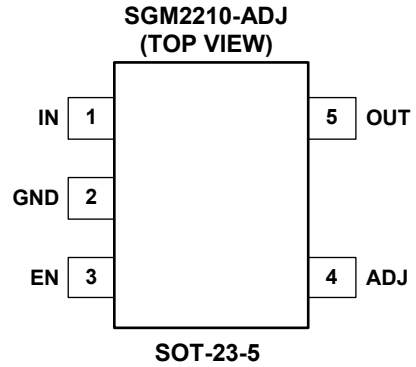
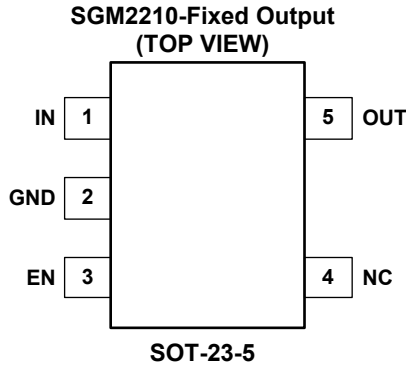

Figure 1. Typical Application Circuits

PIN CONFIGURATIONS



PIN DESCRIPTION

PIN	NAME	FUNCTION
1	IN	Input Supply Voltage Pin. It is recommended to use a 2.2μF or larger ceramic capacitor from IN pin to ground to get good power supply decoupling. This ceramic capacitor should be placed as close as possible to IN pin.
2	GND	Ground.
3	EN	Enable Pin. Drive EN high to turn on the regulator. Drive EN low to turn off the regulator.
4	NC	No Connection (fixed voltage version only).
	ADJ	Feedback Voltage Input Pin (adjustable voltage version only). Connect this pin to the midpoint of an external resistor divider to adjust the output voltage. Place the resistors as close as possible to this pin.
5	OUT	Regulator Output Pin. It is recommended to use a ceramic capacitor with effective capacitance in the range of 1μF to 22μF to ensure stability. This ceramic capacitor should be placed as close as possible to OUT pin.

ELECTRICAL CHARACTERISTICS

(Fixed version, $V_{IN} = V_{OUT(NOM)} + 1V$, $V_{EN} = V_{IN}$, $I_{OUT} = 1mA$, $C_{IN} = C_{OUT} = 2.2\mu F$, $T_J = -40^\circ C$ to $+125^\circ C$, typical values are at $T_J = +25^\circ C$, unless otherwise noted.)

PARAMETER	SYMBOL	CONDITIONS	TEMP	MIN	TYP	MAX	UNITS
Operating Input Voltage	V_{IN}		+25°C	2.5		20	V
Output Voltage Accuracy	V_{OUT}	$I_{OUT} = 1mA$	+25°C	-1		1	%
		$I_{OUT} = 1mA$ to 300mA	-40°C to +125°C	-1.5		1.5	
Line Regulation	$\frac{\Delta V_{OUT}}{\Delta V_{IN} \times V_{OUT}}$	$V_{IN} = (V_{OUT(NOM)} + 1V)$ to 20V, $I_{OUT} = 1mA$	+25°C		0.001	0.005	% / V
			-40°C to +125°C			0.01	
Load Regulation	$\frac{\Delta V_{OUT}}{V_{OUT} \times \Delta I_{OUT}}$	$I_{OUT} = 1mA$ to 300mA	+25°C		0.0005	0.001	% / mA
			-40°C to +125°C			0.003	
Dropout Voltage ⁽¹⁾	V_{DROP}	$I_{OUT} = 100mA$, $V_{OUT} = 3.3V$	+25°C		80	95	mV
			-40°C to +125°C			130	
		$I_{OUT} = 300mA$, $V_{OUT} = 3.3V$	+25°C		240	280	
			-40°C to +125°C			380	
Output Voltage Noise	e_n	$f = 10Hz$ to 100kHz, $I_{OUT} = 10mA$, $V_{OUT} = 3.3V$	+25°C		48		μV_{RMS}
Power Supply Rejection Ratio	PSRR	$V_{IN} = V_{OUT(NOM)} + 1V$, $\Delta V_{RIPPLE} = 0.2V_{P-P}$ $f = 1kHz$, $I_{OUT} = 10mA$, $V_{OUT} = 3.3V$	+25°C		100		dB
		$V_{IN} = V_{OUT(NOM)} + 1V$, $\Delta V_{RIPPLE} = 0.2V_{P-P}$ $f = 10kHz$, $I_{OUT} = 10mA$, $V_{OUT} = 3.3V$	+25°C		82		
Quiescent Current	I_Q	$V_{IN} = (V_{OUT(NOM)} + 1V)$ to 20V, $I_{OUT} = 0mA$	+25°C		36	50	μA
			-40°C to +125°C			60	
		$V_{IN} = (V_{OUT(NOM)} + 1V)$ to 20V, $I_{OUT} = 300mA$	+25°C		620	720	
			-40°C to +125°C			760	
Shutdown Current	I_{SHDN}	$V_{EN} = GND$	+25°C		0.5	1	μA
			-40°C to +125°C			1.5	
Output Current Limit	I_{LIMIT}	$V_{OUT} = 90\%V_{OUT(NOM)}$	+25°C	550	900		mA
Short Circuit Current	I_{SHORT}	$V_{OUT} = 0V$	+25°C		600		mA
Enable Input Logic Low	V_{IL}	$V_{IN} = 2.5V$ to 20V	-40°C to +125°C			0.4	V
Enable Input Logic High	V_{IH}	$V_{IN} = 2.5V$ to 20V	-40°C to +125°C	1.3			
EN Pin Input Current	I_{EN}	$V_{EN} = V_{IN}$	+25°C		300	600	nA
			-40°C to +125°C			1000	
Output Discharge Resistance	R_{DIS}	$V_{IN} = 2.5V$, $V_{EN} = 0V$	+25°C		95		Ω
Thermal Shutdown Temperature	T_{SHDN}				155		°C
Thermal Shutdown Hysteresis	ΔT_{SHDN}				20		°C

NOTE:

1. The dropout voltage is defined as the difference between V_{IN} and V_{OUT} when V_{OUT} falls to $95\% \times V_{OUT(NOM)}$.

ELECTRICAL CHARACTERISTICS (continued)

(Adjustable version, $V_{IN} = V_{OUT(NOM)} + 1V$, $V_{EN} = V_{IN}$, $I_{OUT} = 1mA$, $C_{IN} = C_{OUT} = 2.2\mu F$, $T_J = -40^{\circ}C$ to $+125^{\circ}C$, typical values are at $T_J = +25^{\circ}C$, unless otherwise noted.)

PARAMETER	SYMBOL	CONDITIONS	TEMP	MIN	TYP	MAX	UNITS
Operating Input Voltage	V_{IN}		+25°C	2.5		20	V
Adjustable Voltage	V_{FB}		+25°C		1.2		V
Adjustable Voltage Accuracy		$I_{OUT} = 1mA$	+25°C	-1		1	%
		$I_{OUT} = 1mA$ to 300mA	-40°C to +125°C	-1.5		1.5	
Line Regulation	$\frac{\Delta V_{OUT}}{\Delta V_{IN} \times V_{OUT}}$	$V_{IN} = (V_{OUT(NOM)} + 1V)$ to 20V, $I_{OUT} = 1mA$	+25°C		0.001	0.005	%V
			-40°C to +125°C			0.01	
Load Regulation	$\frac{\Delta V_{OUT}}{V_{OUT} \times \Delta I_{OUT}}$	$I_{OUT} = 1mA$ to 300mA	+25°C		0.0005	0.001	%mA
			-40°C to +125°C			0.003	
Dropout Voltage ⁽¹⁾	V_{DROP}	$I_{OUT} = 100mA$, $V_{OUT} = 3.3V$	+25°C		80	95	mV
			-40°C to +125°C			130	
		$I_{OUT} = 300mA$, $V_{OUT} = 3.3V$	+25°C		240	280	
			-40°C to +125°C			380	
Output Voltage Noise	e_n	$f = 10Hz$ to 100kHz, $I_{OUT} = 10mA$, $V_{OUT} = 3.3V$	+25°C		48		μV_{RMS}
ADJ Pin Current	I_{ADJ}		+25°C		1	3	nA
			-40°C to +125°C			5	
Power Supply Rejection Ratio	PSRR	$V_{IN} = V_{OUT(NOM)} + 1V$, $\Delta V_{RIPPLE} = 0.2V_{P-P}$ $f = 1kHz$, $I_{OUT} = 10mA$, $V_{OUT} = 3.3V$	+25°C		100		dB
			$V_{IN} = V_{OUT(NOM)} + 1V$, $\Delta V_{RIPPLE} = 0.2V_{P-P}$ $f = 10kHz$, $I_{OUT} = 10mA$, $V_{OUT} = 3.3V$	+25°C		82	
Quiescent Current	I_Q	$V_{IN} = (V_{OUT(NOM)} + 1V)$ to 20V, $I_{OUT} = 0mA$	+25°C		36	50	μA
			-40°C to +125°C			60	
		$V_{IN} = (V_{OUT(NOM)} + 1V)$ to 20V, $I_{OUT} = 300mA$	+25°C		620	720	
			-40°C to +125°C			760	
Shutdown Current	I_{SHDN}	$V_{EN} = GND$	+25°C		0.5	1	μA
			-40°C to +125°C			1.5	
Output Current Limit	I_{LIMIT}	$V_{OUT} = 90\%V_{OUT(NOM)}$	+25°C	550	900		mA
Short Circuit Current	I_{SHORT}	$V_{OUT} = 0V$	+25°C		600		mA
Enable Input Logic Low	V_{IL}	$V_{IN} = 2.5V$ to 20V	-40°C to +125°C			0.4	V
Enable Input Logic High	V_{IH}	$V_{IN} = 2.5V$ to 20V	-40°C to +125°C	1.3			
EN Pin Input Current	I_{EN}	$V_{EN} = V_{IN}$	+25°C		300	600	nA
			-40°C to +125°C			1000	
Output Discharge Resistance	R_{DIS}	$V_{IN} = 2.5V$, $V_{EN} = 0V$	+25°C		95		Ω
Thermal Shutdown Temperature	T_{SHDN}				155		°C
Thermal Shutdown Hysteresis	ΔT_{SHDN}				20		°C

NOTE:

1. The dropout voltage is defined as the difference between V_{IN} and V_{OUT} when V_{OUT} falls to $95\% \times V_{OUT(NOM)}$.

TYPICAL PERFORMANCE CHARACTERISTICS

$T_J = +25^\circ\text{C}$, $V_{IN} = V_{OUT(NOM)} + 1\text{V}$, $V_{EN} = V_{IN}$, $C_{IN} = C_{OUT} = 2.2\mu\text{F}$, unless otherwise noted.

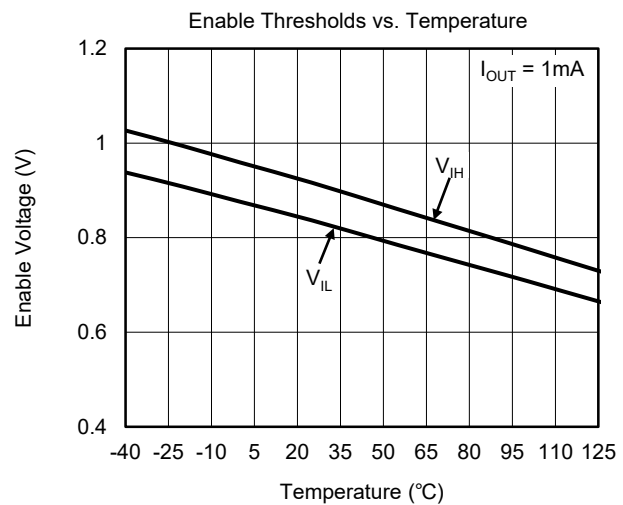
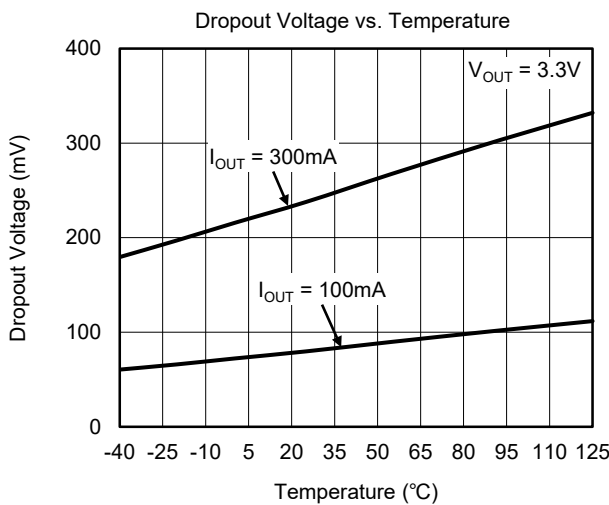
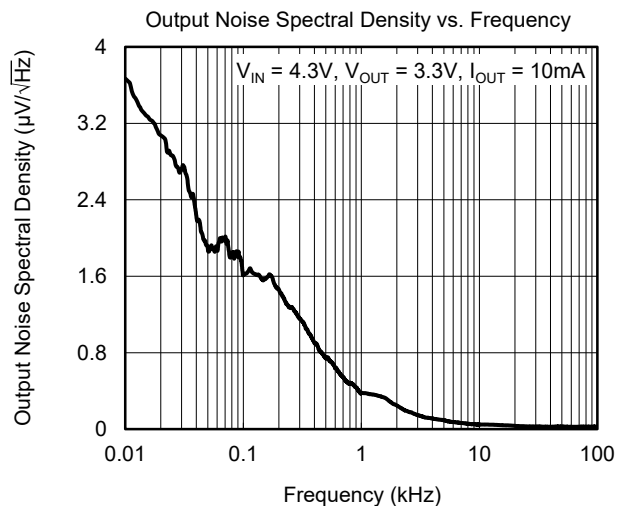
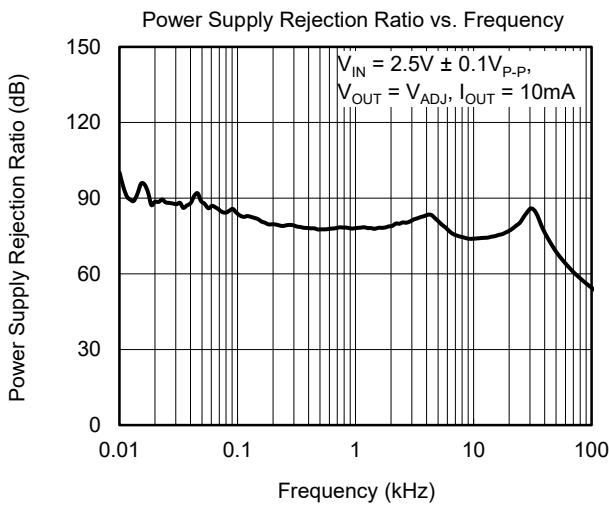
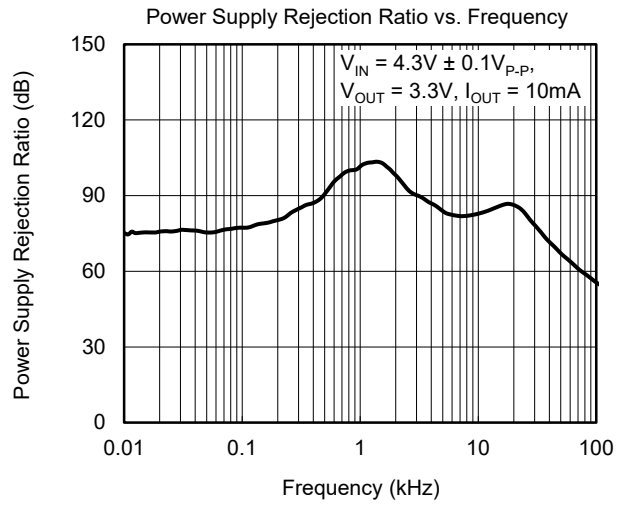
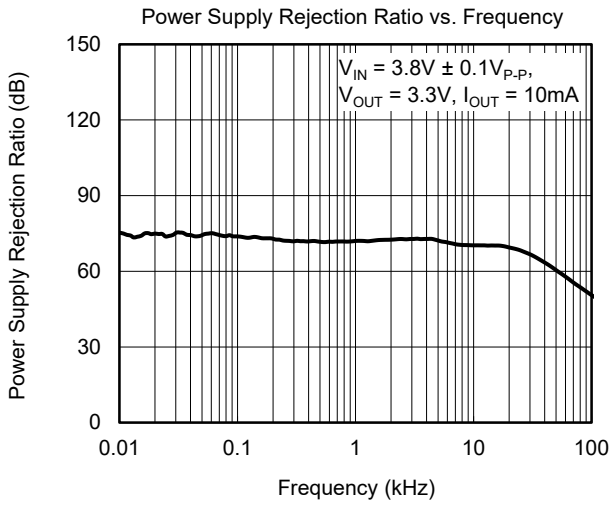

TYPICAL PERFORMANCE CHARACTERISTICS (continued)

$T_J = +25^\circ\text{C}$, $V_{IN} = V_{OUT(NOM)} + 1\text{V}$, $V_{EN} = V_{IN}$, $C_{IN} = C_{OUT} = 2.2\mu\text{F}$, unless otherwise noted.

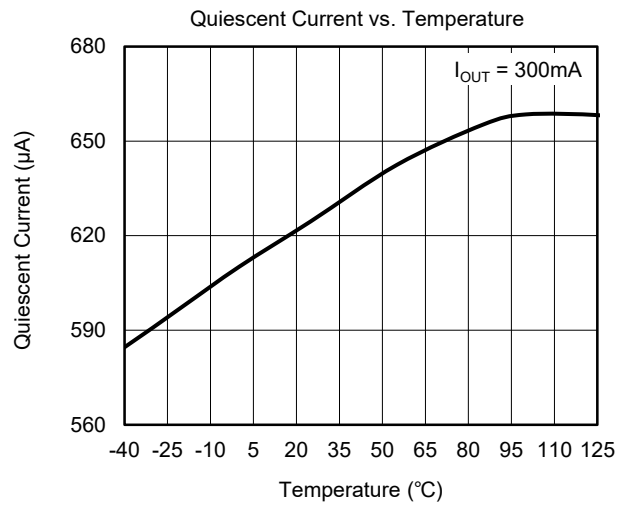
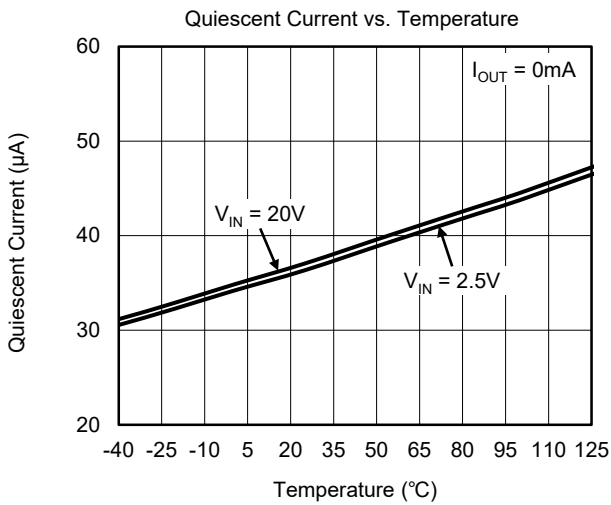
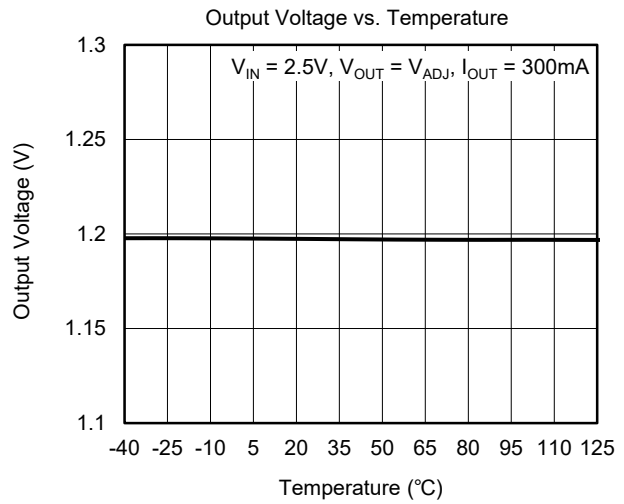
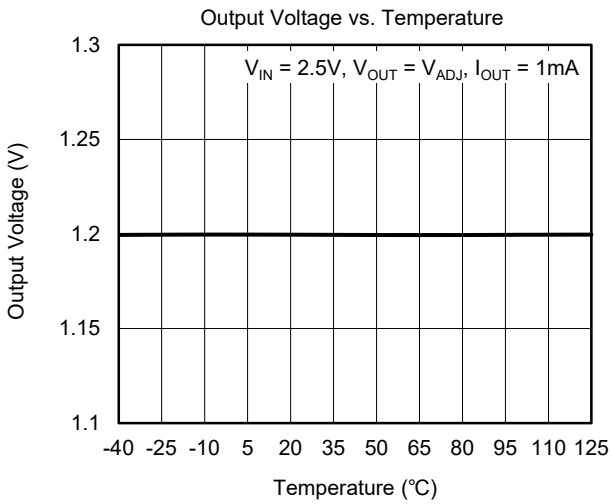
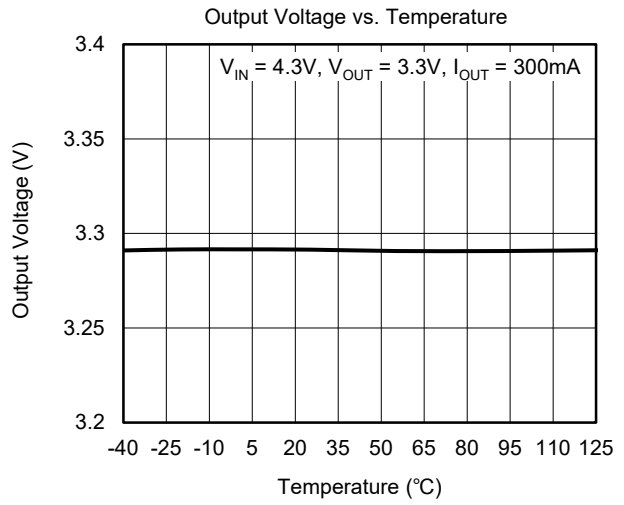
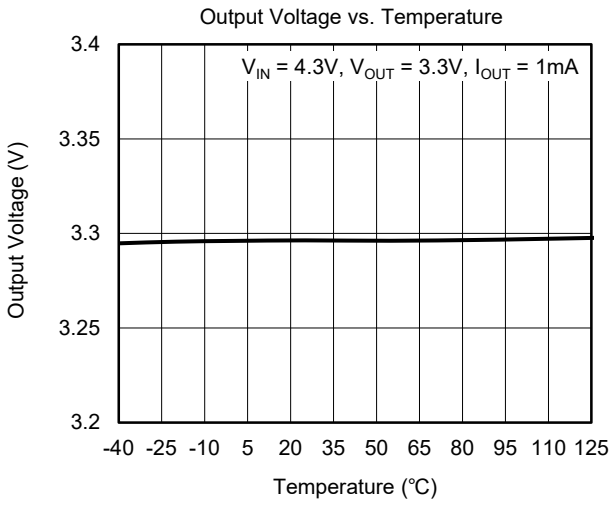

TYPICAL PERFORMANCE CHARACTERISTICS (continued)

$T_J = +25^\circ\text{C}$, $V_{IN} = V_{OUT(NOM)} + 1\text{V}$, $V_{EN} = V_{IN}$, $C_{IN} = C_{OUT} = 2.2\mu\text{F}$, unless otherwise noted.

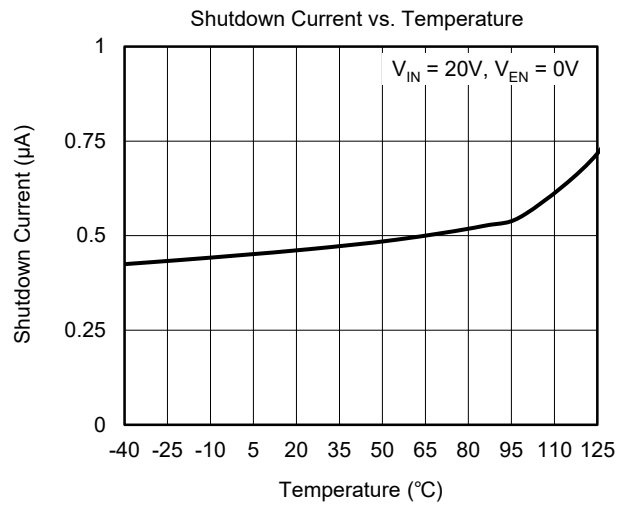
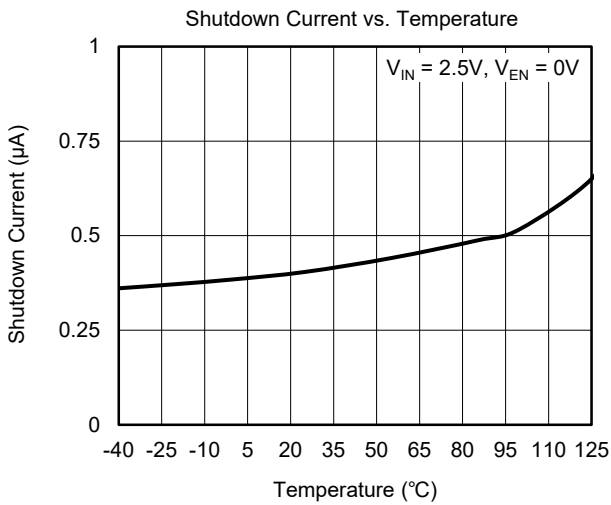
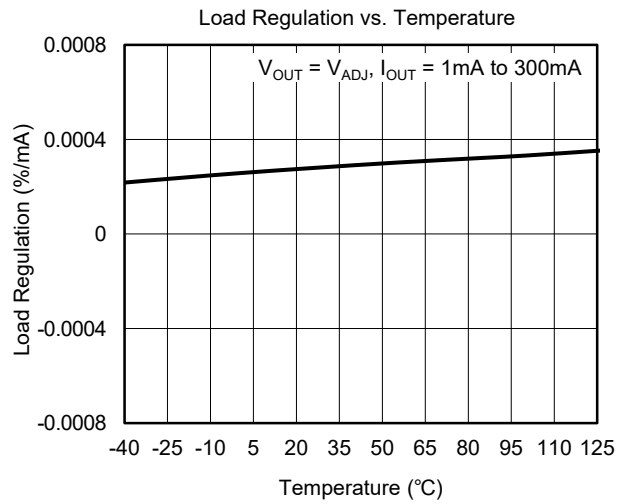
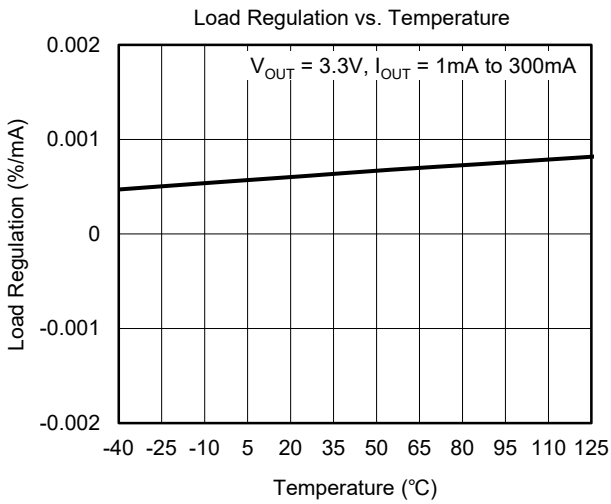
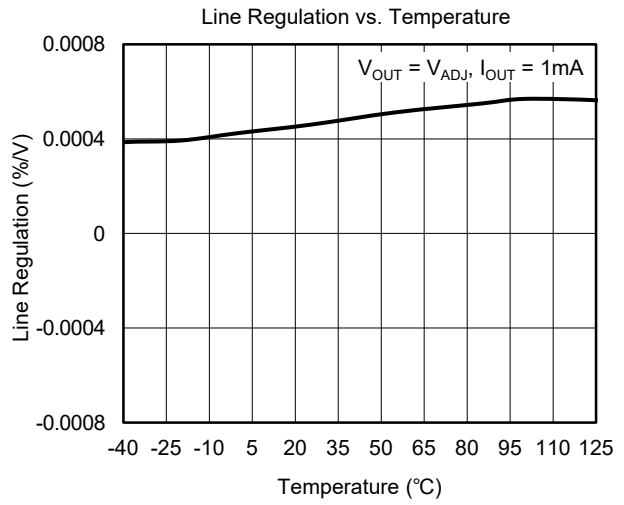
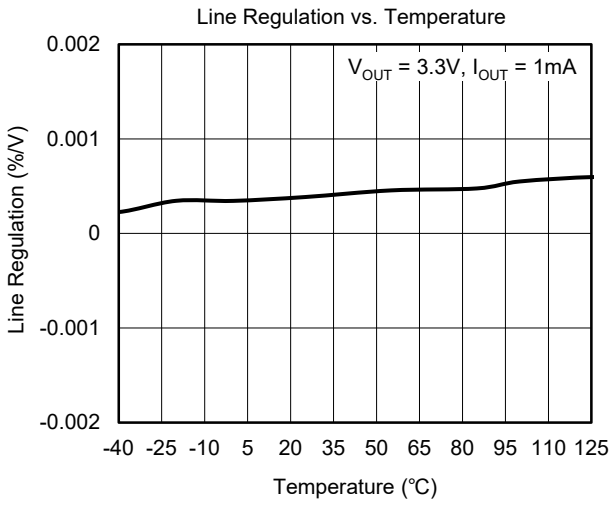

TYPICAL PERFORMANCE CHARACTERISTICS (continued)

$T_J = +25^\circ\text{C}$, $V_{IN} = V_{OUT(NOM)} + 1\text{V}$, $V_{EN} = V_{IN}$, $C_{IN} = C_{OUT} = 2.2\mu\text{F}$, unless otherwise noted.

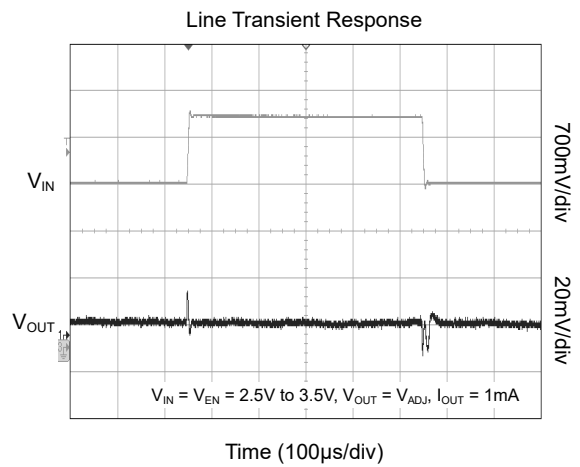
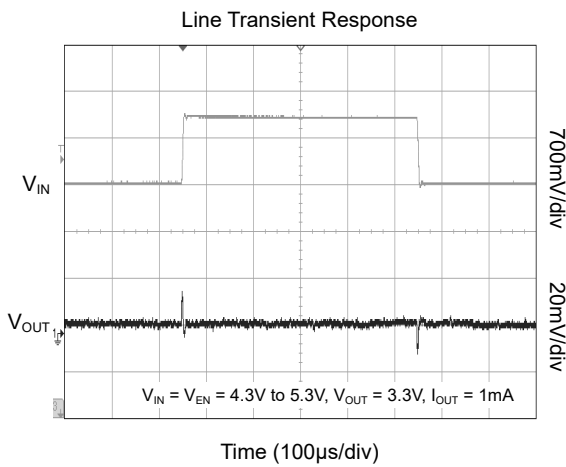
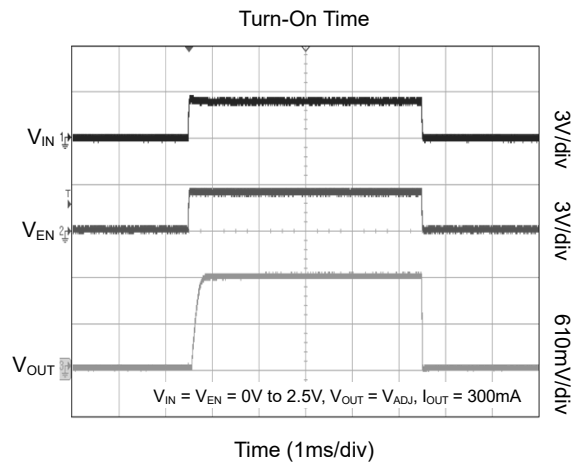
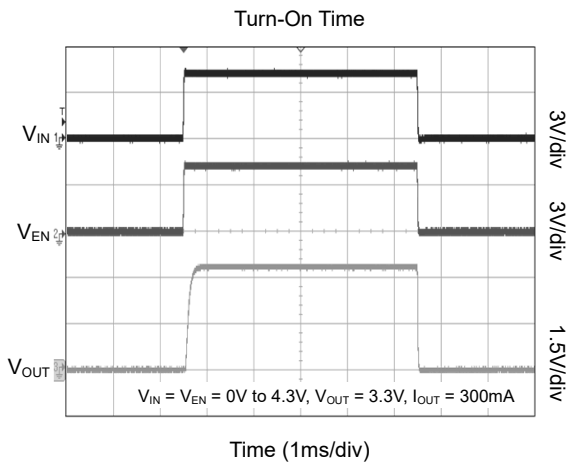
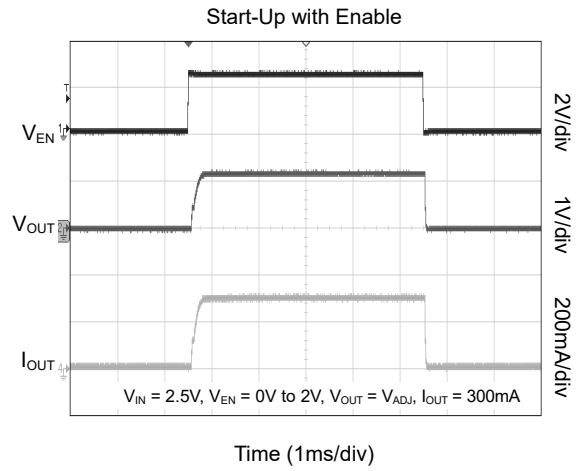
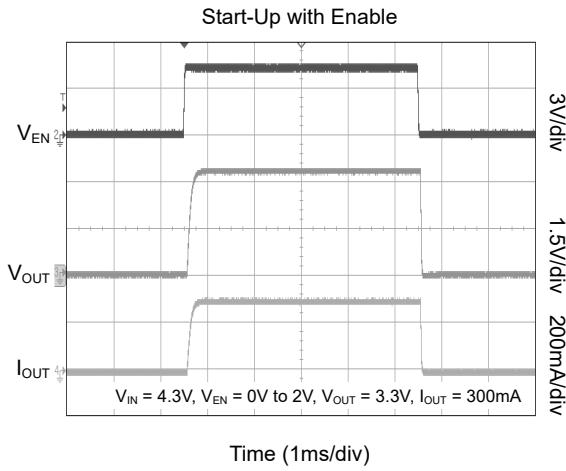

TYPICAL PERFORMANCE CHARACTERISTICS (continued)

$T_J = +25^\circ\text{C}$, $V_{IN} = V_{OUT(NOM)} + 1\text{V}$, $V_{EN} = V_{IN}$, $C_{IN} = C_{OUT} = 2.2\mu\text{F}$, unless otherwise noted.

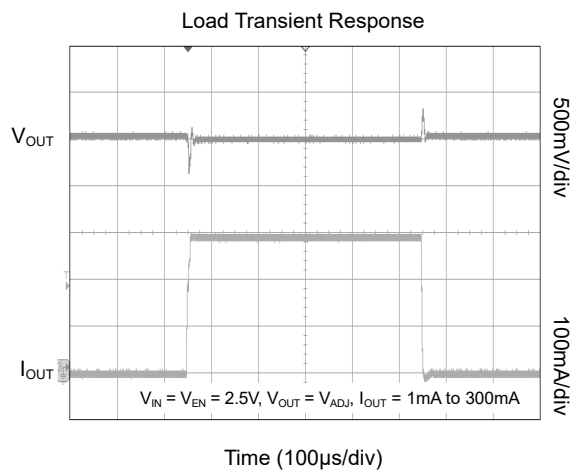
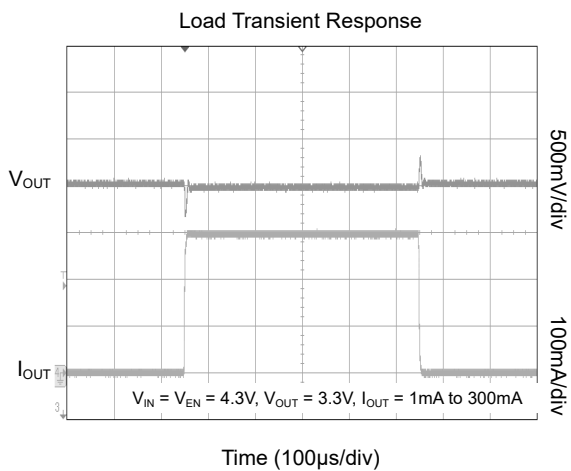

FUNCTIONAL BLOCK DIAGRAM

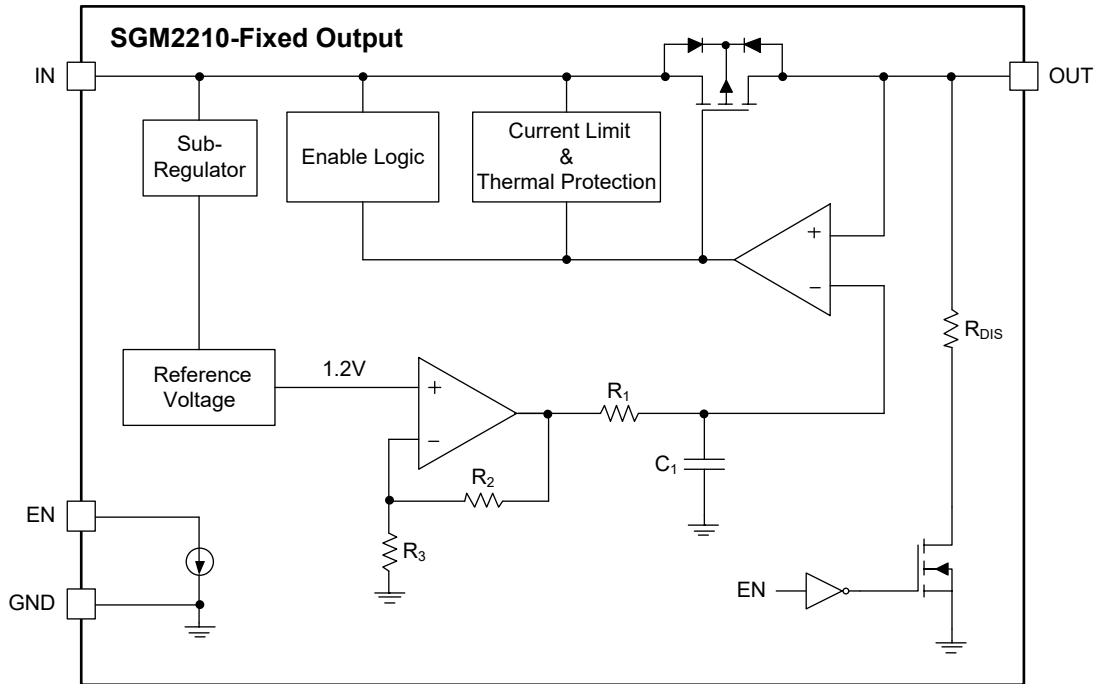

Figure 2. Fixed Version Block Diagram

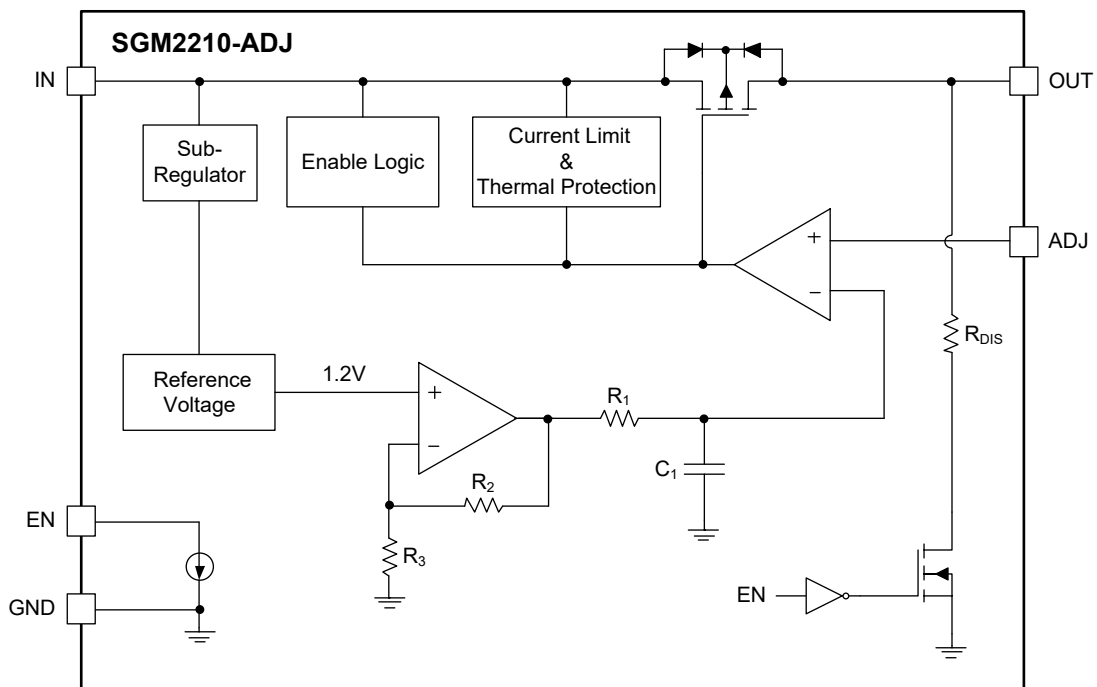

Figure 3. Adjustable Version Block Diagram

APPLICATION INFORMATION

The SGM2210 is a low quiescent current, low noise and low dropout voltage linear regulator and provides 300mA output current. These features make the device a reliable solution to solve many challenging problems in the generation of clean and accurate power supply. The high performance also makes the SGM2210 useful in a variety of applications. The SGM2210 provides protection functions for output overload, output short-circuit condition and overheating.

The SGM2210 provides an EN pin as an external chip enable control to enable/disable the device. When the regulator is in shutdown state, the shutdown current consumes as low as 0.5µA (TYP).

Input Capacitor Selection (C_{IN})

The input decoupling capacitor should be placed as close as possible to the IN pin for ensuring the device stability. 2.2µF or larger X7R or X5R ceramic capacitor is selected to get good dynamic performance.

When V_{IN} is required to provide large current instantaneously, a large effective input capacitor is required. Multiple input capacitors can limit the input tracking inductance. Adding more input capacitors is available to restrict the ringing and to keep it below the device absolute maximum ratings.

Output Capacitor Selection (C_{OUT})

The output decoupling capacitor should be placed as close as possible to the OUT pin. 2.2µF or larger X7R or X5R ceramic capacitor is selected to get good dynamic performance. The minimum effective capacitance of C_{OUT} that SGM2210 can remain stable is 1µF. For ceramic capacitor, temperature, DC bias and package size will change the effective capacitance, so enough margin of C_{OUT} must be considered in design. Additionally, C_{OUT} with larger capacitance and lower ESR will help increase the high frequency PSRR and improve the load transient response.

Adjustable Regulator

The output voltage of the SGM2210-ADJ can be adjusted from 1.2V to 12V. The ADJ pin will be connected to two external resistors as shown in Figure 4. The output voltage is determined by the following equation:

$$V_{OUT} = V_{FB} \times \left(1 + \frac{R_1}{R_2} \right) \quad (1)$$

where:

V_{OUT} is output voltage and V_{FB} is the internal voltage reference, $V_{FB} = 1.2V$.

One parallel capacitor (C_1) with R_1 can be used to improve the feedback loop stability and PSRR, increase the transient response and reduce the output noise. Use $R_2 = 150k\Omega$ to maintain an 8µA minimum load.

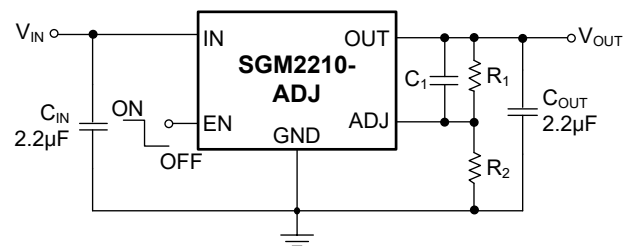

Figure 4. Adjustable Output Voltage Application

Enable Operation

The EN pin of the SGM2210 is used to enable/disable the device and to deactivate/activate the output automatic discharge function.

When the EN pin voltage is lower than 0.4V, the device is in shutdown state. There is no current flowing from IN to OUT pins. In this state, the automatic discharge transistor is active to discharge the output voltage through a 95Ω (TYP) resistor.

When the EN pin voltage is higher than 1.3V, the device is in active state. The output voltage is regulated to expected value and the automatic discharge transistor is turned off.

Reverse Current Protection

The power transistor has an inherent body diode, this body diode will be forward biased when $V_{OUT} > V_{IN}$. When $V_{OUT} > V_{IN}$, the reverse current flowing from the OUT pin to the IN pin will damage the SGM2210. If $V_{OUT} > (V_{IN} + 0.3V)$ is expected in the application, one external Schottky diode will be added between the OUT pin and IN pin to protect the SGM2210.

Output Current Limit and Short-Circuit Protection

When overload events happen, the output current is internally limited to 900mA (TYP). When the OUT pin is shorted to ground, the short-circuit protection will limit the output current to 600mA (TYP).

APPLICATION INFORMATION (continued)**Thermal Shutdown**

The SGM2210 can detect the temperature of die. When the die temperature exceeds the threshold value of thermal shutdown, the SGM2210 will be in shutdown state and it will remain in this state until the die temperature decreases to +135°C.

Layout Guidelines

To get good PSRR, low output noise and high transient response performance, the input and output bypass capacitors must be placed as close as possible to the IN pin and OUT pin separately. V_{IN} and V_{OUT} had better use separate ground planes and these ground planes are single point connected to the GND pin.

REVISION HISTORY

NOTE: Page numbers for previous revisions may differ from page numbers in the current version.

DECEMBER 2021 – REV.A to REV.A.1	Page
Updated Electrical Characteristics section	4, 5
Changes from Original (DECEMBER 2019) to REV.A	Page
Changed from product preview to production data	All

PACKAGE OUTLINE DIMENSIONS

SOT-23-5

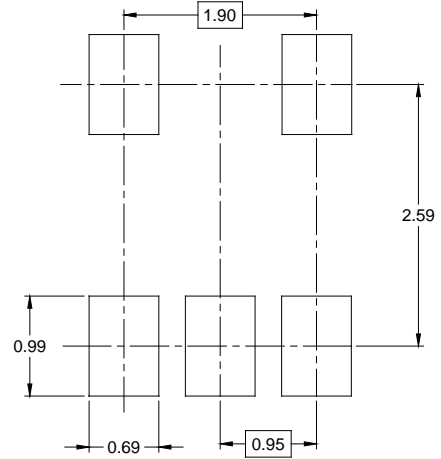
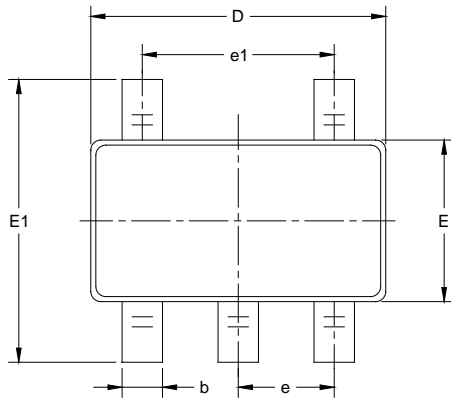

RECOMMENDED LAND PATTERN (Unit: mm)

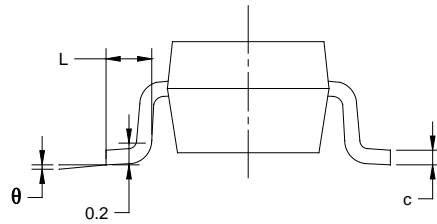
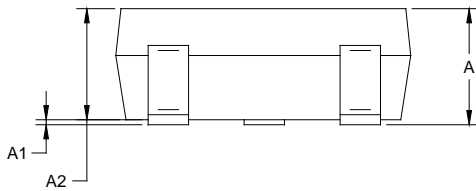

Symbol	Dimensions In Millimeters		Dimensions In Inches	
	MIN	MAX	MIN	MAX
A	1.050	1.250	0.041	0.049
A1	0.000	0.100	0.000	0.004
A2	1.050	1.150	0.041	0.045
b	0.300	0.500	0.012	0.020
c	0.100	0.200	0.004	0.008
D	2.820	3.020	0.111	0.119
E	1.500	1.700	0.059	0.067
E1	2.650	2.950	0.104	0.116
e	0.950 BSC		0.037 BSC	
e1	1.900 BSC		0.075 BSC	
L	0.300	0.600	0.012	0.024
θ	0°	8°	0°	8°

NOTES:

1. Body dimensions do not include mode flash or protrusion.
2. This drawing is subject to change without notice.

PACKAGE INFORMATION

TAPE AND REEL INFORMATION

REEL DIMENSIONS



TAPE DIMENSIONS



NOTE: The picture is only for reference. Please make the object as the standard.

KEY PARAMETER LIST OF TAPE AND REEL

Package Type	Reel Diameter	Reel Width W1 (mm)	A0 (mm)	B0 (mm)	K0 (mm)	P0 (mm)	P1 (mm)	P2 (mm)	W (mm)	Pin1 Quadrant
SOT-23-5	7"	9.5	3.20	3.20	1.40	4.0	4.0	2.0	8.0	Q3

DD0001

PACKAGE INFORMATION

CARTON BOX DIMENSIONS



NOTE: The picture is only for reference. Please make the object as the standard.

KEY PARAMETER LIST OF CARTON BOX

Reel Type	Length (mm)	Width (mm)	Height (mm)	Pizza/Carton
7" (Option)	368	227	224	8
7"	442	410	224	18

DD0002