



74LVC1T45

Single-Bit Dual-Supply Bus Transceiver with Configurable Voltage Translation

GENERAL DESCRIPTION

The 74LVC1T45 is a single-bit, dual-supply bus transceiver with configurable voltage translation. The device has two separate configurable power-supply rails. The A and B ports track the V_{CCA} supply and V_{CCB} supply respectively. The supply voltage pins accept voltage range from 1.65V to 5.5V, which makes the device suitable for low voltage bidirectional translation voltage nodes of 1.8V, 2.5V, 3.3V, and 5V.

The 74LVC1T45 features that two data buses can communicate asynchronously. Either the A port outputs or the B port outputs can be activated by DIR logic levels. The DIR input circuit is supplied by V_{CCA} . When B port outputs are activated, the device allows the data to transmit from A bus to B bus. On the contrary, when A port outputs are activated, the device allows the data to transmit from B bus to A bus. The input circuit is always active on the two ports. A logic level of high or low must be set to avoid excessive supply current.

FEATURES

- V_{CCA} Supply Voltage Range: 1.65V to 5.5V
- V_{CCB} Supply Voltage Range: 1.65V to 5.5V
- DIR Input Circuit Referenced to V_{CCA}
- +32mA/-32mA Output Current
- Data Rates
 - ◆ 420Mbps (3.3V to 5V Translation)
 - ◆ 210Mbps (Translate to 3.3V)
 - ◆ 140Mbps (Translate to 2.5V)
 - ◆ 75Mbps (Translate to 1.8V)
- Outputs in High-Impedance State when V_{CCA} or $V_{CCB} = 0V$
- -40°C to +125°C Operating Temperature Range
- Available in Green SC70-6, SOT-23-6 Packages

APPLICATIONS

Personal Electronic Devices
Industrial and Enterprise Devices
Telecommunications

Single-Bit Dual-Supply Bus Transceiver with Configurable Voltage Translation

74LVC1T45

PACKAGE/ORDERING INFORMATION

MODEL	PACKAGE DESCRIPTION	SPECIFIED TEMPERATURE RANGE	ORDERING NUMBER	PACKAGE MARKING	PACKING OPTION
74LVC1T45	SC70-6	-40°C to +125°C	74LVC1T45XC6G/TR	MCTXX	Tape and Reel, 3000
	SOT-23-6	-40°C to +125°C	74LVC1T45XN6G/TR	MCSXX	Tape and Reel, 3000

MARKING INFORMATION

NOTE: XX = Date Code.

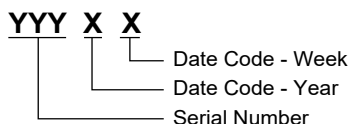

Green (RoHS & HSF): SG Micro Corp defines "Green" to mean Pb-Free (RoHS compatible) and free of halogen substances. If you have additional comments or questions, please contact your SGMICRO representative directly.

ABSOLUTE MAXIMUM RATINGS ⁽¹⁾

Supply Voltage Range, V_{CCA}	-0.5V to 6.5V
Supply Voltage Range, V_{CCB}	-0.5V to 6.5V
Input Voltage Range, V_I ⁽²⁾	-0.5V to 6.5V
Output Voltage Range, V_O ⁽²⁾	
High-Impedance State	-0.5V to 6.5V
High-State or Low-State	
A Ports	-0.5V to MIN (6.5V, $V_{CCA} + 0.5V$)
B Ports	-0.5V to MIN (6.5V, $V_{CCB} + 0.5V$)
Input Clamp Current, I_{IK} ($V_I < 0$).....	-50mA
Output Clamp Current, I_{OK} ($V_O < 0$).....	-50mA
Output Current, I_O	
High-State or Low-State.....	$\pm 50mA$
Supply Current, I_{CCA} or I_{CCB}	100mA
Ground Current, I_{GND}	-100mA
Junction Temperature ⁽³⁾	+150°C
Storage Temperature Range	-65°C to +150°C
Lead Temperature (Soldering, 10s).....	+260°C
ESD Susceptibility	
HBM.....	4000V
CDM.....	1000V

OVERSTRESS CAUTION

1. Stresses beyond those listed in Absolute Maximum Ratings may cause permanent damage to the device. Exposure to absolute maximum rating conditions for extended periods may affect reliability. Functional operation of the

device at any conditions beyond those indicated in the Recommended Operating Conditions section is not implied.

2. The input negative-voltage and output voltage ratings may be exceeded if the input and output current ratings are observed.

3. The performance capability of a high-performance integrated circuit in conjunction with its thermal environment can create junction temperatures which are detrimental to reliability.

ESD SENSITIVITY CAUTION

This integrated circuit can be damaged if ESD protections are not considered carefully. SGMICRO recommends that all integrated circuits be handled with appropriate precautions. Failure to observe proper handling and installation procedures can cause damage. ESD damage can range from subtle performance degradation to complete device failure. Precision integrated circuits may be more susceptible to damage because even small parametric changes could cause the device not to meet the published specifications.

DISCLAIMER

SG Micro Corp reserves the right to make any change in circuit design, or specifications without prior notice.

Single-Bit Dual-Supply Bus Transceiver with Configurable Voltage Translation

74LVC1T45

RECOMMENDED OPERATING CONDITIONS

Supply Voltage Range, V_{CCA}	1.65V to 5.5V
Supply Voltage Range, V_{CCB}	1.65V to 5.5V
Input Voltage Range, V_I0V to 5.5V
Output Voltage Range, V_O	
High-Impedance State0V to 5.5V
High-State or Low-State	
A Ports0V to V_{CCA}
B Ports0V to V_{CCB}
High-State or Low-State.....	$\pm 32\text{mA}$

Input Transition Rise or Fall Rate, $\Delta t/\Delta V$

Data Inputs	
$V_{CCI} = 1.65\text{V to }1.95\text{V}$	20ns/V (MAX)
$V_{CCI} = 2.3\text{V to }2.7\text{V}$	20ns/V (MAX)
$V_{CCI} = 3\text{V to }3.6\text{V}$	10ns/V (MAX)
$V_{CCI} = 4.5\text{V to }5.5\text{V}$	5ns/V (MAX)
Control Input	
$V_{CCI} = 1.65\text{V to }5.5\text{V}$	5ns/V (MAX)
Operating Temperature Range	-40°C to +125°C

LOGIC DIAGRAM

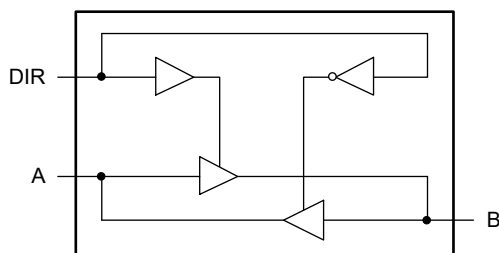

FUNCTION TABLE

SUPPLY VOLTAGE	CONTROL INPUT	INPUT/OUTPUT ⁽¹⁾	
V_{CCA}, V_{CCB}	DIR ⁽²⁾	A	B
1.65V to 5.5V	L	A = B	Input
1.65V to 5.5V	H	Input	B = A
GND ⁽³⁾	X	Z	Z

H = High Voltage Level

L = Low Voltage Level

X = Don't Care

Z = High-Impedance State

NOTES:

1. The input circuit of the data I/O is always active.
2. The DIR input circuit is referenced to V_{CCA} .
3. If at least one of V_{CCA} or V_{CCB} is at GND level, the outputs in High-Impedance State.

PIN CONFIGURATION

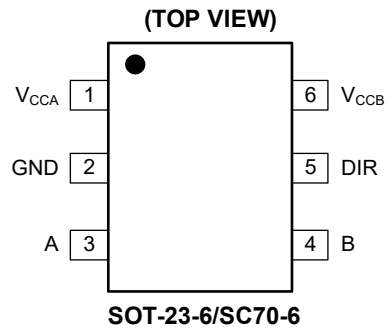

PIN DESCRIPTION

PIN	NAME	FUNCTION
SOT-23-6/SC70-6		
1	V _{CCA}	Supply Voltage on A Port.
2	GND	Ground.
3	A	Input/Output. It tracks the V _{CCA} supply.
4	B	Input/Output. It tracks the V _{CCB} supply.
5	DIR	Direction Control Input. It tracks the V _{CCA} supply.
6	V _{CCB}	Supply Voltage on B Port.

PACKAGE OUTLINE DIMENSIONS

SC70-6

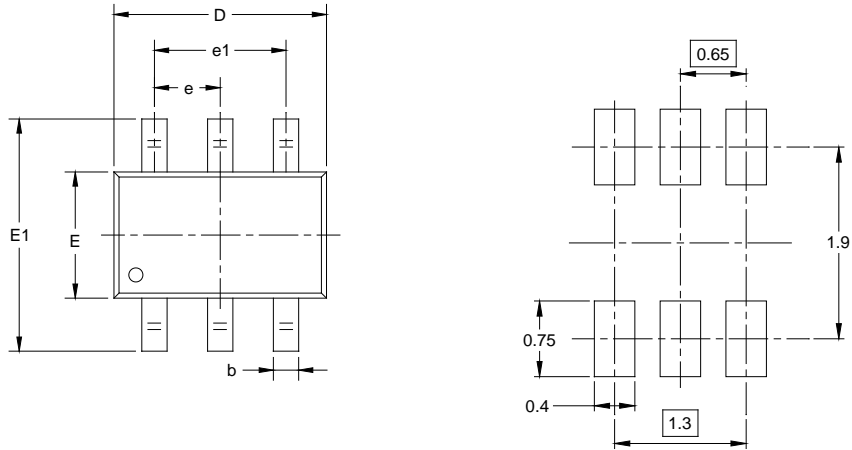

RECOMMENDED LAND PATTERN (Unit: mm)

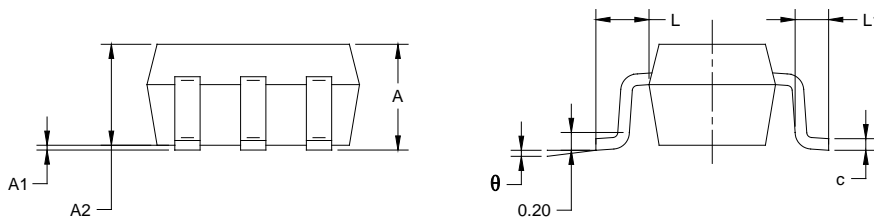

Symbol	Dimensions In Millimeters		Dimensions In Inches	
	MIN	MAX	MIN	MAX
A	0.800	1.100	0.031	0.043
A1	0.000	0.100	0.000	0.004
A2	0.800	1.000	0.031	0.039
b	0.150	0.350	0.006	0.014
c	0.080	0.220	0.003	0.009
D	2.000	2.200	0.079	0.087
E	1.150	1.350	0.045	0.053
E1	2.150	2.450	0.085	0.096
e	0.65 TYP		0.026 TYP	
e1	1.300 BSC		0.051 BSC	
L	0.525 REF		0.021 REF	
L1	0.260	0.460	0.010	0.018
θ	0°	8°	0°	8°

- NOTES:
 1. Body dimensions do not include mode flash or protrusion.
 2. This drawing is subject to change without notice.

PACKAGE OUTLINE DIMENSIONS

SOT-23-6

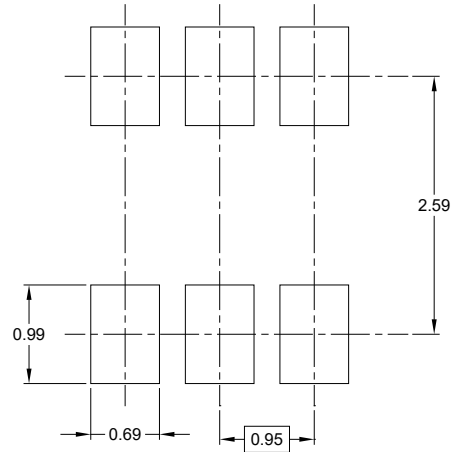
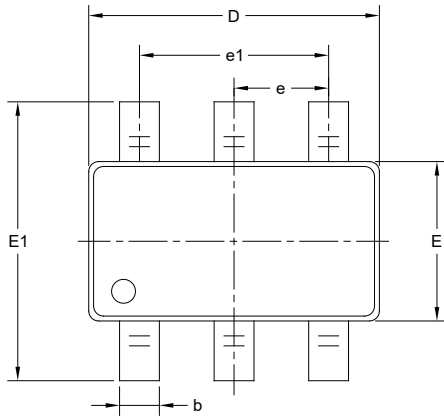

RECOMMENDED LAND PATTERN (Unit: mm)

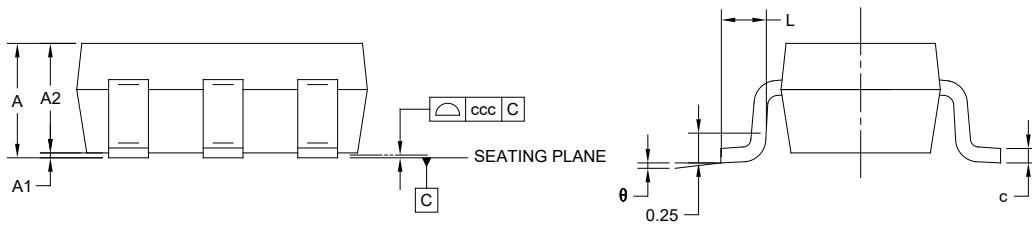

Symbol	Dimensions In Millimeters		
	MIN	MOD	MAX
A	-	-	1.450
A1	0.000	-	0.150
A2	0.900	-	1.300
b	0.300	-	0.500
c	0.080	-	0.220
D	2.750	-	3.050
E	1.450	-	1.750
E1	2.600	-	3.000
e	0.950 BSC		
e1	1.900 BSC		
L	0.300	-	0.600
θ	0°	-	8°
ccc	0.100		

NOTES:

1. This drawing is subject to change without notice.
2. The dimensions do not include mold flashes, protrusions or gate burrs.
3. Reference JEDEC MO-178.

PACKAGE INFORMATION

TAPE AND REEL INFORMATION

REEL DIMENSIONS



TAPE DIMENSIONS



NOTE: The picture is only for reference. Please make the object as the standard.

KEY PARAMETER LIST OF TAPE AND REEL

Package Type	Reel Diameter	Reel Width W1 (mm)	A0 (mm)	B0 (mm)	K0 (mm)	P0 (mm)	P1 (mm)	P2 (mm)	W (mm)	Pin1 Quadrant
SC70-6	7"	9.5	2.40	2.50	1.20	4.0	4.0	2.0	8.0	Q3
SOT-23-6	7"	9.5	3.23	3.17	1.37	4.0	4.0	2.0	8.0	Q3

D00001

PACKAGE INFORMATION

CARTON BOX DIMENSIONS



NOTE: The picture is only for reference. Please make the object as the standard.

KEY PARAMETER LIST OF CARTON BOX

Reel Type	Length (mm)	Width (mm)	Height (mm)	Pizza/Carton
7" (Option)	368	227	224	8
7"	442	410	224	18

DD0002