



SGM2018

1 μ A Ultra-Low Current Consumption and Low Dropout CMOS Voltage Regulators

GENERAL DESCRIPTION

The SGM2018 series are positive voltage regulators with ultra-low current consumption, low dropout voltage, high-accuracy output voltage and 250mA output current, developed in CMOS technology.

Output capacitor as small as 0.1 μ F can be used. The SGM2018 series operate with an ultra-low current consumption and only 1 μ A typical current is consumed to prolong the battery run-time.

The built-in low on-resistance transistor realizes low dropout voltage and a large output current. A built-in over-current protection circuit prevents the load current from exceeding the current capacity of the output transistor. Reverse leakage current is 0.4 μ A (TYP) when $V_{OUT} > V_{IN}$.

Compared with voltage regulators using a conventional CMOS technology, more types of capacitors, including small input and output capacitors, can be used with the SGM2018 series. The SGM2018 series feature ultra-low current consumption and come in small packages, making them most suitable for portable equipment.

The SGM2018 series is available in Green SOT-23-5 and UTDFN-1 \times 1-4AL packages. It operates over an operating temperature range of -40 $^{\circ}$ C to +85 $^{\circ}$ C.

FEATURES

- **Fixed Output Voltage Versions:**
1.8V, 2.8V, 3.0V and 3.3V
- **Input Voltage Range:** 1.7V to 5V
- **Output Voltage Accuracy:** $\pm 1.2\%$ at +25 $^{\circ}$ C
- **Low Dropout Voltage:** 70mV (TYP) at 100mA
- **Ultra-Low Current Consumption:** 1 μ A (TYP)
- **250mA Nominal Output Current**
- **Low Reverse Leakage Current:**
0.4 μ A (TYP) when $V_{OUT} > V_{IN}$
- **Built-In Over-Temperature Protection**
- **Built-In Over-Current Protection Circuit**
- **Supports 1.8V Logic for EN Pin**
- **-40 $^{\circ}$ C to +85 $^{\circ}$ C Operating Temperature Range**
- **Available in Green SOT-23-5 and UTDFN-1 \times 1-4AL Packages**

APPLICATIONS

Wearable Device
Smart Phone
Portable Equipment

PACKAGE/ORDERING INFORMATION

MODEL	PACKAGE DESCRIPTION	SPECIFIED TEMPERATURE RANGE	ORDERING NUMBER	PACKAGE MARKING	PACKING OPTION
SGM2018-1.8	SOT-23-5	-40°C to +85°C	SGM2018-1.8YN5G/TR	CM1XX	Tape and Reel, 3000
	UTDFN-1×1-4AL	-40°C to +85°C	SGM2018-1.8YUDH4G/TR	N3X	Tape and Reel, 10000
SGM2018-2.8	SOT-23-5	-40°C to +85°C	SGM2018-2.8YN5G/TR	CM2XX	Tape and Reel, 3000
	UTDFN-1×1-4AL	-40°C to +85°C	SGM2018-2.8YUDH4G/TR	N4X	Tape and Reel, 10000
SGM2018-3.0	SOT-23-5	-40°C to +85°C	SGM2018-3.0YN5G/TR	CM3XX	Tape and Reel, 3000
	UTDFN-1×1-4AL	-40°C to +85°C	SGM2018-3.0YUDH4G/TR	N5X	Tape and Reel, 10000
SGM2018-3.3	SOT-23-5	-40°C to +85°C	SGM2018-3.3YN5G/TR	CM4XX	Tape and Reel, 3000
	UTDFN-1×1-4AL	-40°C to +85°C	SGM2018-3.3YUDH4G/TR	N6X	Tape and Reel, 10000

MARKING INFORMATION

NOTE: X = Date Code. XX = Date Code.

SOT-23-5

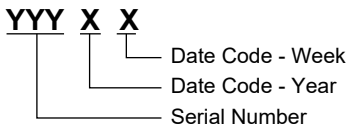

UTDFN-1×1-4AL

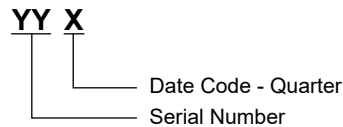

Green (RoHS & HSF): SG Micro Corp defines "Green" to mean Pb-Free (RoHS compatible) and free of halogen substances. If you have additional comments or questions, please contact your SGMICRO representative directly.

ABSOLUTE MAXIMUM RATINGS

- IN to GND -0.3V to 6V
- OUT to GND -0.3V to 6V
- EN to GND..... -0.3V to 6V
- Package Thermal Resistance
- SOT-23-5, θ_{JA} 207°C/W
- UTDFN-1×1-4AL, θ_{JA} 238°C/W
- Junction Temperature +150°C
- Storage Temperature Range -65°C to +150°C
- Lead Temperature (Soldering, 10s) +260°C
- ESD Susceptibility
- HBM..... 7000V
- CDM 1000V

RECOMMENDED OPERATING CONDITIONS

- Input Voltage Range 1.7V to 5V
- Operating Junction Temperature Range..... -40°C to +85°C
- Input Capacitance, C_{IN} 1µF (MIN)
- Output Capacitance, C_{OUT} 0.1µF to 10µF

OVERSTRESS CAUTION

Stresses beyond those listed in Absolute Maximum Ratings may cause permanent damage to the device. Exposure to absolute maximum rating conditions for extended periods may affect reliability. Functional operation of the device at any conditions beyond those indicated in the Recommended Operating Conditions section is not implied.

ESD SENSITIVITY CAUTION

This integrated circuit can be damaged by ESD if you don't pay attention to ESD protection. SGMICRO recommends that all integrated circuits be handled with appropriate precautions. Failure to observe proper handling and installation procedures can cause damage. ESD damage can range from subtle performance degradation to complete device failure. Precision integrated circuits may be more susceptible to damage because very small parametric changes could cause the device not to meet its published specifications.

DISCLAIMER

SG Micro Corp reserves the right to make any change in circuit design, or specifications without prior notice.

PIN CONFIGURATIONS

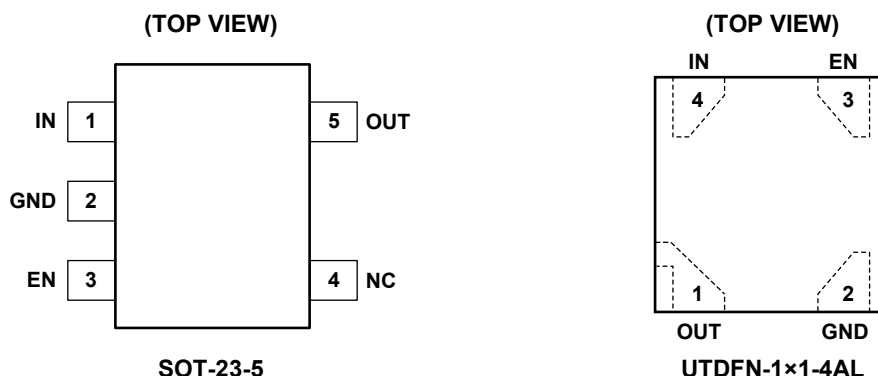

PIN DESCRIPTION

PIN		NAME	FUNCTION
SOT-23-5	UTDFN-1x1-4AL		
1	4	IN	Input Voltage Supply Pin.
2	2	GND	Ground Pin.
3	3	EN	Enable Pin. This pin has an internal pull-down current source. A logic low disables the regulator. Connect to logic high for normal operation.
4	–	NC	Not Connected.
5	1	OUT	Output Voltage Pin. It is recommended to use output capacitor with effective capacitance in the range of 0.1µF to 10µF.

ELECTRICAL CHARACTERISTICS

($V_{IN} = V_{OUT(NOM)} + 1V$, $I_{OUT} = 0.1mA$, $V_{EN} = 5V$, $C_{IN} = 1\mu F$ and $C_{OUT} = 0.1\mu F$, $T_J = -40^\circ C$ to $+85^\circ C$, typical values are at $T_J = +25^\circ C$, unless otherwise noted.)

PARAMETER	SYMBOL	CONDITIONS	TEMP	MIN	TYP	MAX	UNITS
Input Voltage Range	V_{IN}		$-40^\circ C$ to $+85^\circ C$	1.7		5	V
Output Voltage Accuracy	V_{OUT}	$V_{IN} = (V_{OUT(NOM)} + 1V)$ to 5V	$+25^\circ C$	-1.2		1.2	%
Maximum Output Current ⁽¹⁾			$+25^\circ C$	250			mA
Current Limit	I_{LIM}		$+25^\circ C$	280	480		mA
Supply Pin Current	I_Q	No load	$-40^\circ C$ to $+85^\circ C$		1.0	1.5	µA
Dropout Voltage ⁽²⁾	V_{DROP}	$I_{OUT} = 100mA$, SOT-23-5	$V_{OUT(NOM)} = 1.8V$	$+25^\circ C$	145	200	mV
			$V_{OUT(NOM)} = 2.8V$	$+25^\circ C$	95	130	
			$V_{OUT(NOM)} = 3.0V$	$+25^\circ C$	90	130	
			$V_{OUT(NOM)} = 3.3V$	$+25^\circ C$	85	110	
		$I_{OUT} = 100mA$, UTDFN-1×1-4AL	$V_{OUT(NOM)} = 1.8V$	$+25^\circ C$	130	175	mV
			$V_{OUT(NOM)} = 2.8V$	$+25^\circ C$	80	110	
			$V_{OUT(NOM)} = 3.0V$	$+25^\circ C$	75	110	
			$V_{OUT(NOM)} = 3.3V$	$+25^\circ C$	70	90	
Line Regulation	$\frac{\Delta V_{OUT}}{\Delta V_{IN} \times V_{OUT}}$	$V_{IN} = (V_{OUT(NOM)} + 1V)$ to 5V	$+25^\circ C$		0.015	0.25	%/V
Load Regulation	ΔV_{OUT}	$I_{OUT} = 0.1mA$ to 250mA	$+25^\circ C$		3	15	mV
Short Current Limit	I_{SHORT}	$V_{OUT} = 0V$	$+25^\circ C$		100		mA
Reverse Leakage Current	I_{RL}	$V_{IN} = 1.7V$, $V_{OUT} = 5.5V$	$+25^\circ C$		0.4		µA
Power Supply Rejection Ratio	PSRR	$I_{OUT} = 30mA$, $V_{OUT(NOM)} = 1.8V$, $\Delta V_{RIPPLE} = 0.2V_{P-P}$	$f = 217Hz$	$+25^\circ C$		38	dB
			$f = 1kHz$	$+25^\circ C$		27	
Output Voltage Temperature Coefficient ⁽³⁾	$\frac{\Delta V_{OUT}}{\Delta T_J \times V_{OUT}}$		$-40^\circ C$ to $+85^\circ C$		10		ppm/ $^\circ C$
Shutdown							
EN Input Threshold	V_{IH}	$V_{IN} = 1.7V$ to 5V	$-40^\circ C$ to $+85^\circ C$	1.4			V
	V_{IL}		$-40^\circ C$ to $+85^\circ C$			0.4	
EN Input Bias Current	I_{BH}	$V_{EN} = 5.5V$	$-40^\circ C$ to $+85^\circ C$		25	500	nA
	I_{BL}	$V_{EN} = 0V$	$-40^\circ C$ to $+85^\circ C$	-500		500	
Shutdown Supply Current	I_{SHDN}	$V_{IN} = 5V$, $V_{EN} = 0V$	$+25^\circ C$		0.15	0.3	µA
			$-40^\circ C$ to $+85^\circ C$			0.65	
Output Discharge Resistance	R_{DISCH}	$V_{EN} = 0V$, $V_{OUT} = 0.5V$	$+25^\circ C$		50		Ω
Thermal Shutdown Temperature	T_{SHDN}				165		$^\circ C$
Thermal Shutdown Hysteresis	ΔT_{SHDN}				30		$^\circ C$

NOTES:

- Maximum output current is affected by the PCB layout, size of metal trace, the thermal conduction path between metal layers, ambient temperature and the other environment factors of system. Attention should be paid to the dropout voltage when $V_{IN} < (V_{OUT} + V_{DROP})$.
- Dropout voltage is characterized when V_{OUT} falls 5% below $V_{OUT(NOM)}$.
- Output voltage temperature coefficient is defined as the worst-case voltage change divided by the total temperature range.

TYPICAL PERFORMANCE CHARACTERISTICS

$T_J = +25^\circ\text{C}$, $V_{IN} = V_{OUT(NOM)} + 1\text{V}$, $V_{OUT(NOM)} = 1.8\text{V}$, $V_{EN} = 5\text{V}$, $C_{IN} = 1\mu\text{F}$ and $C_{OUT} = 0.1\mu\text{F}$, unless otherwise noted.

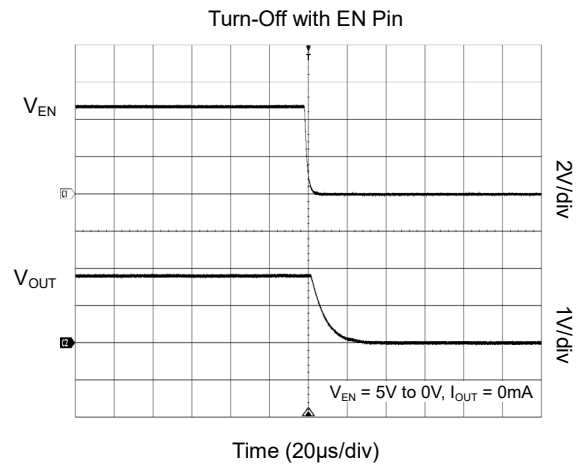
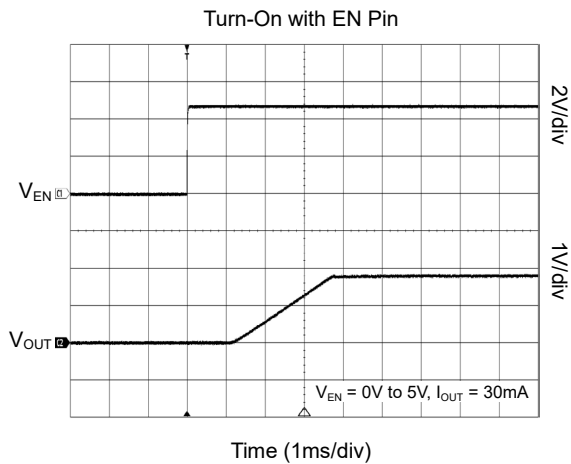
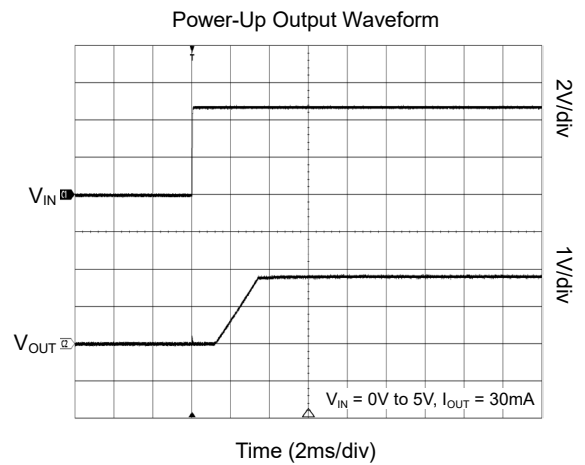
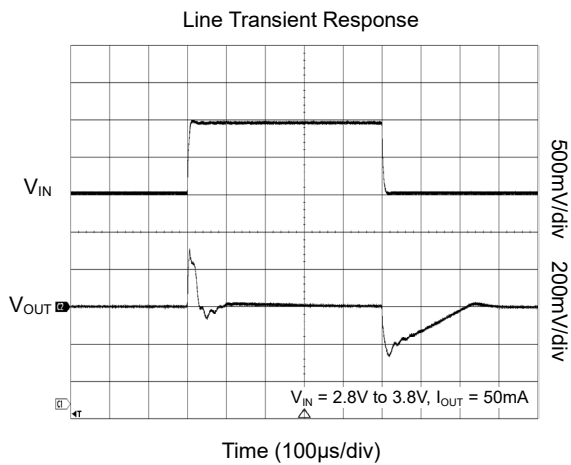
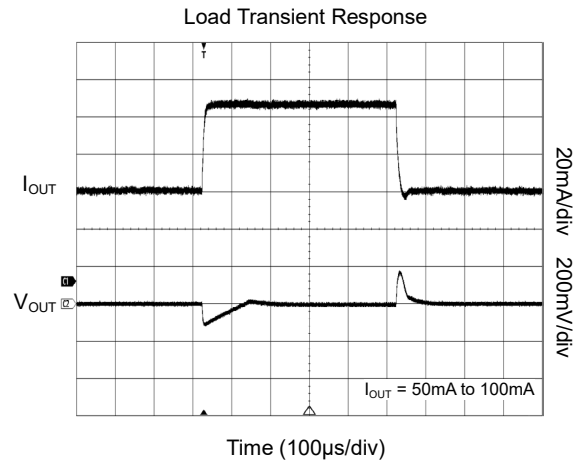
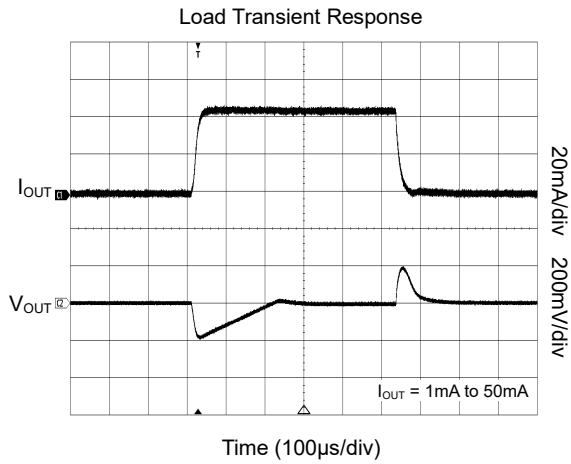

TYPICAL PERFORMANCE CHARACTERISTICS (continued)

T_J = +25°C, V_{IN} = V_{OUT(NOM)} + 1V, V_{OUT(NOM)} = 1.8V, V_{EN} = 5V, C_{IN} = 1µF and C_{OUT} = 0.1µF, unless otherwise noted.

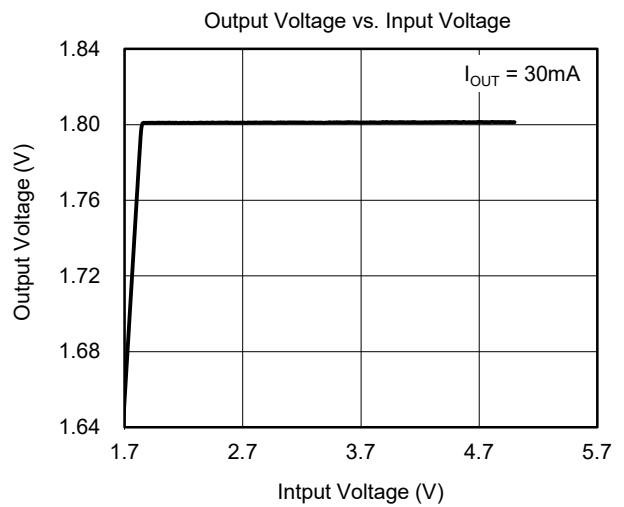
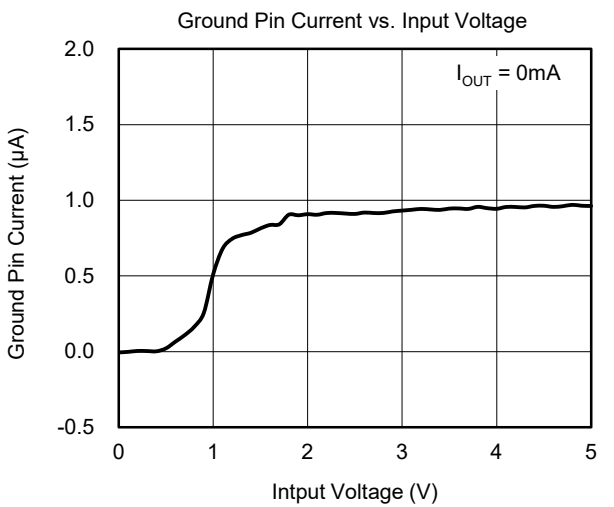
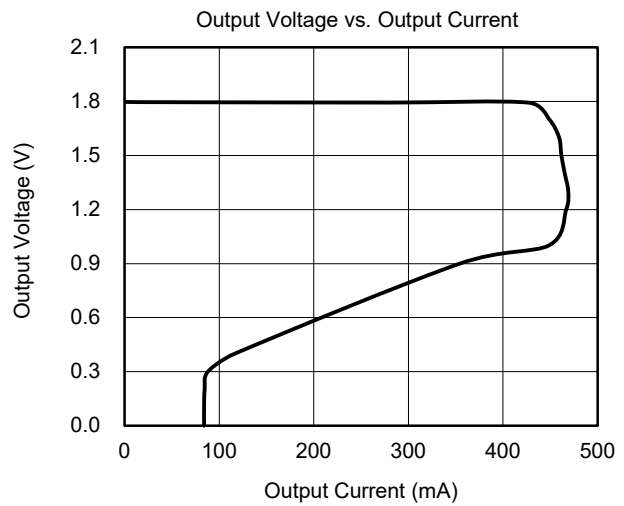
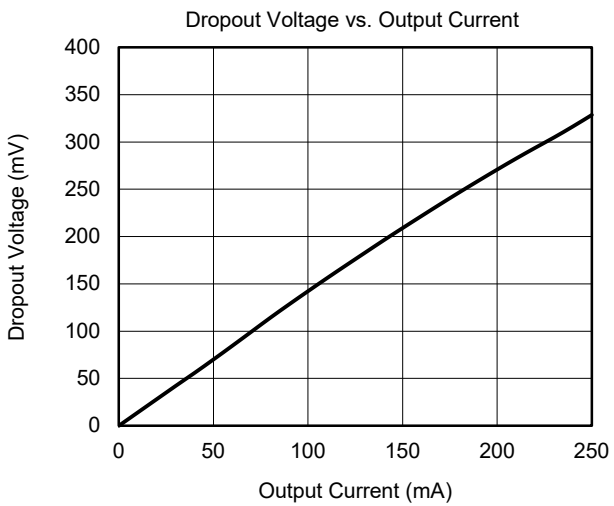
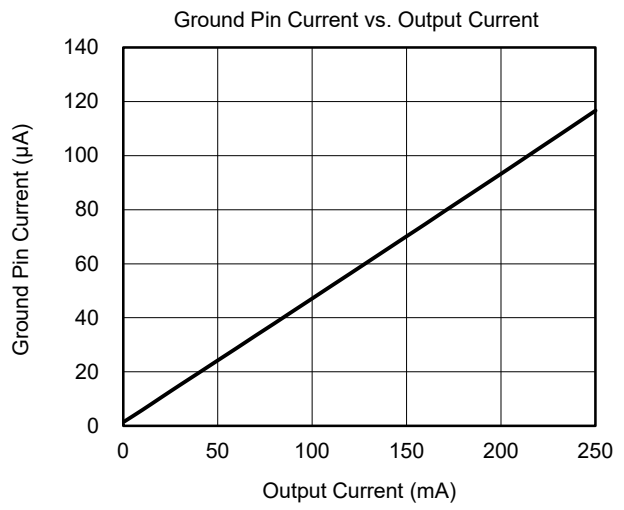
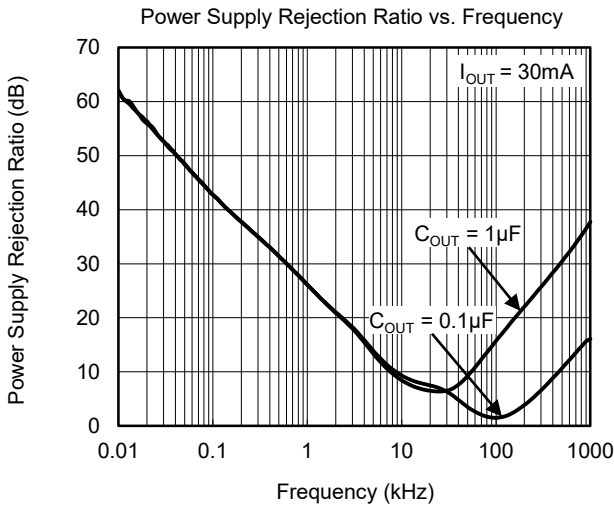

TYPICAL PERFORMANCE CHARACTERISTICS (continued)

$T_J = +25^\circ\text{C}$, $V_{IN} = V_{OUT(NOM)} + 1\text{V}$, $V_{OUT(NOM)} = 1.8\text{V}$, $V_{EN} = 5\text{V}$, $C_{IN} = 1\mu\text{F}$ and $C_{OUT} = 0.1\mu\text{F}$, unless otherwise noted.

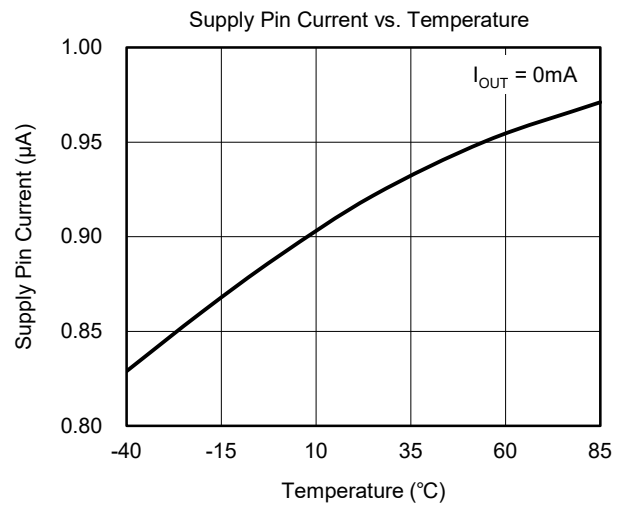
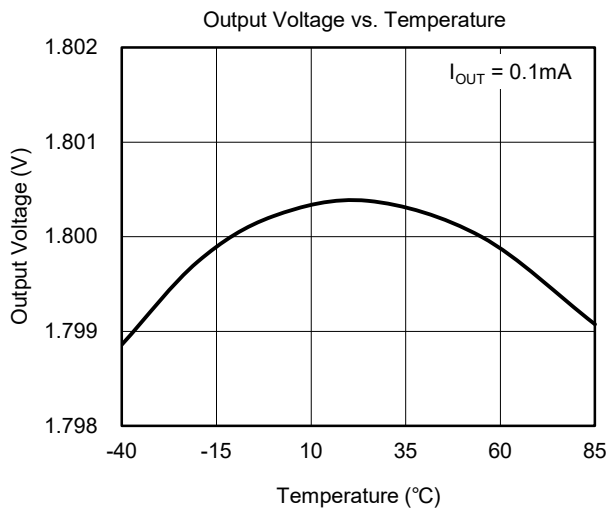

FUNCTIONAL BLOCK DIAGRAM

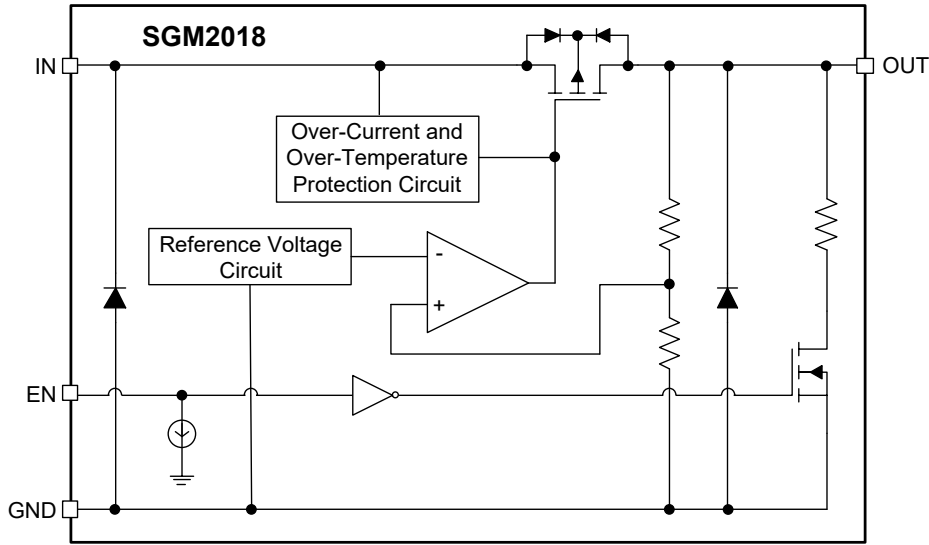

Figure 1. Block Diagram

APPLICATION INFORMATION

Application Circuit

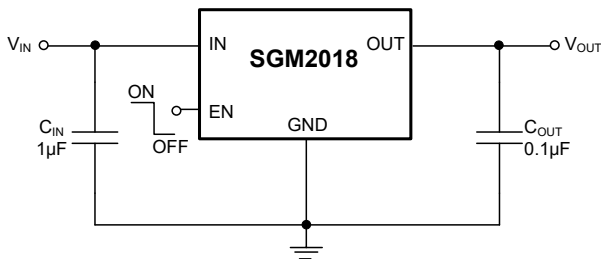

Figure 2. Application Circuit

Conditions of Application

Input Capacitor (C_{IN}): 1µF or higher

Output Capacitor (C_{OUT}): 0.1µF or higher

Caution: Generally regulator may oscillate depending on the selection of external components.

Confirm that no oscillation occurs in the application for which the above capacitors are used.

Selection of Input and Output Capacitors

The SGM2018 series require an output capacitor (C_{OUT}) between the OUT pin and GND pin for phase compensation.

Operation is stable with a ceramic capacitor of 0.1µF or higher in the entire temperature range. When using an OS capacitor, a tantalum capacitor, or an aluminum

electrolytic capacitor, the capacitance must be 0.1µF or higher.

The value of the output overshoot or undershoot transient response varies depending on the value of the output capacitor.

The required capacitance of the input capacitor (C_{IN}) differs depending on the application.

The recommended value for an application is $C_{IN} \geq 1\mu F$, $C_{OUT} \geq 0.1\mu F$; however, when selecting these capacitors, perform sufficient evaluation, including evaluation of temperature characteristics, on the actual device.

The SGM2018 series enable use of a low equivalent series resistance capacitor, such as a ceramic capacitor, for the output-side capacitor (C_{OUT}).

Over-Current Protection Circuit

The SGM2018 series include an over-current protection circuit having the characteristics shown in the table of Electrical Characteristics, in order to protect the output transistor against an excessive output current and short circuiting between the OUT and GND pins. The current when the output pin is short-circuited (I_{SHORT}) is internally set at approximately 100mA (TYP), and the normal value is restored for the output voltage, if the short circuit condition is released.

REVISION HISTORY

NOTE: Page numbers for previous revisions may differ from page numbers in the current version.

JUNE 2020 – REV.A to REV.A.1	Page
Updated Absolute Maximum Ratings section.....	2

Changes from Original (JANUARY 2020) to REV.A	Page
Changed from product preview to production data.....	All

PACKAGE INFORMATION

PACKAGE OUTLINE DIMENSIONS

SOT-23-5

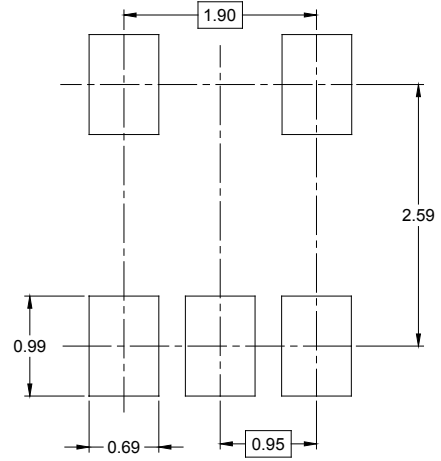
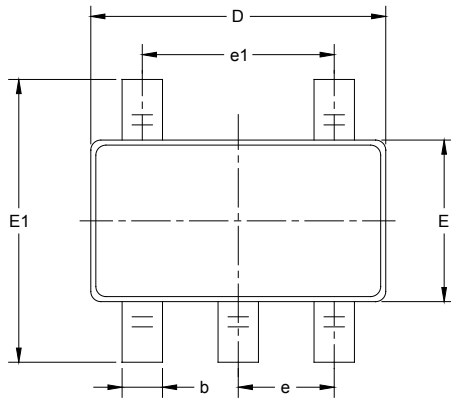

RECOMMENDED LAND PATTERN (Unit: mm)

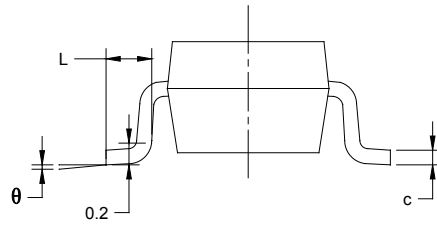
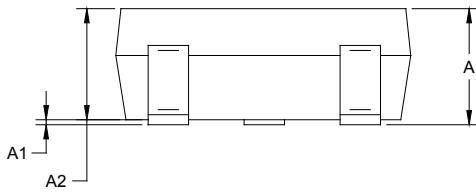

Symbol	Dimensions In Millimeters		Dimensions In Inches	
	MIN	MAX	MIN	MAX
A	1.050	1.250	0.041	0.049
A1	0.000	0.100	0.000	0.004
A2	1.050	1.150	0.041	0.045
b	0.300	0.500	0.012	0.020
c	0.100	0.200	0.004	0.008
D	2.820	3.020	0.111	0.119
E	1.500	1.700	0.059	0.067
E1	2.650	2.950	0.104	0.116
e	0.950 BSC		0.037 BSC	
e1	1.900 BSC		0.075 BSC	
L	0.300	0.600	0.012	0.024
θ	0°	8°	0°	8°

PACKAGE OUTLINE DIMENSIONS

UTDFN-1x1-4AL

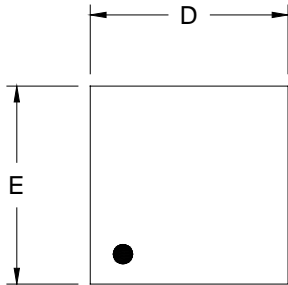

TOP VIEW

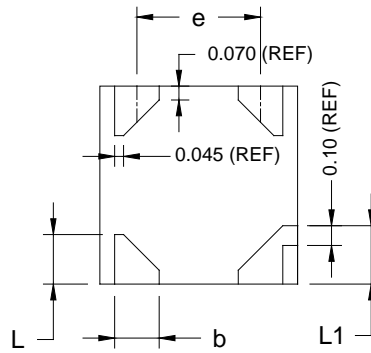

BOTTOM VIEW

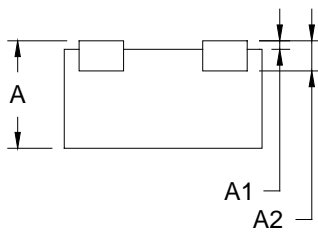

SIDE VIEW

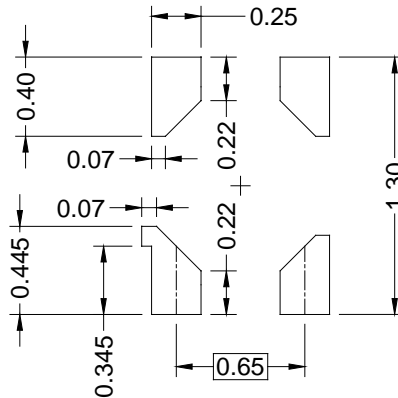

RECOMMENDED LAND PATTERN (Unit: mm)

Symbol	Dimensions In Millimeters		
	MIN	MOD	MAX
A	0.500	0.550	0.600
A1	0.000		0.050
A2	0.152 REF		
e	0.625 BSC		
D	0.950	1.000	1.050
E	0.950	1.000	1.050
b	0.175	0.225	0.275
L	0.200	0.250	0.300
L1	0.245	0.295	0.345

TAPE AND REEL INFORMATION

REEL DIMENSIONS

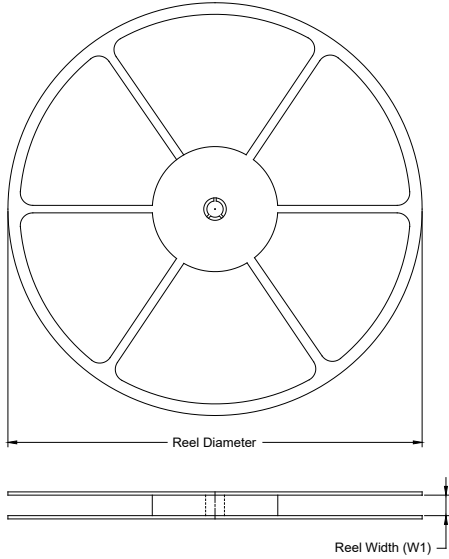

TAPE DIMENSIONS

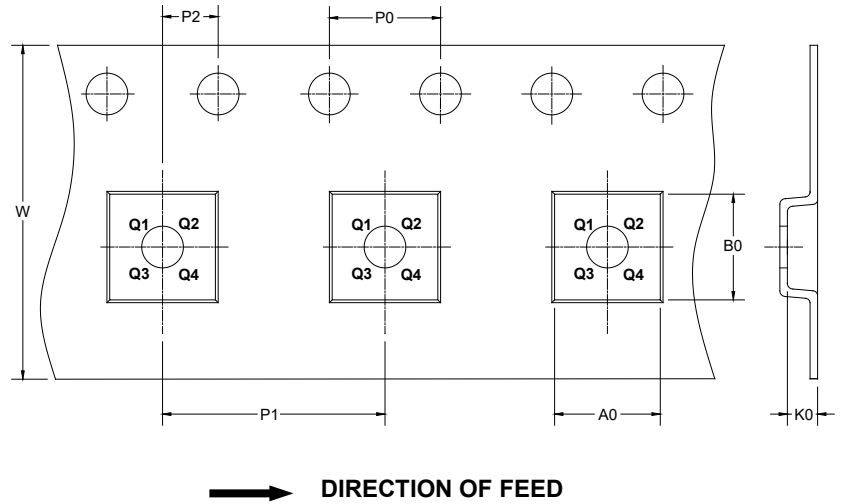

NOTE: The picture is only for reference. Please make the object as the standard.

KEY PARAMETER LIST OF TAPE AND REEL

Package Type	Reel Diameter	Reel Width W1 (mm)	A0 (mm)	B0 (mm)	K0 (mm)	P0 (mm)	P1 (mm)	P2 (mm)	W (mm)	Pin1 Quadrant
SOT-23-5	7"	9.5	3.20	3.20	1.40	4.0	4.0	2.0	8.0	Q3
UTDFN-1×1-4AL	7"	9.0	1.18	1.18	0.68	4.0	2.0	2.0	8.0	Q1

DD0001

PACKAGE INFORMATION

CARTON BOX DIMENSIONS

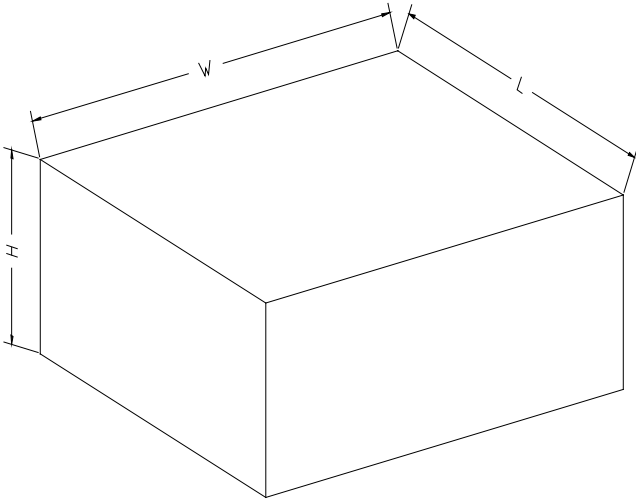

NOTE: The picture is only for reference. Please make the object as the standard.

KEY PARAMETER LIST OF CARTON BOX

Reel Type	Length (mm)	Width (mm)	Height (mm)	Pizza/Carton
7" (Option)	368	227	224	8
7"	442	410	224	18

DD0002