

GENERAL DESCRIPTION

The SGM2061 is a linear regulator capable of supplying 450mA output current from 1.9V input voltage. The device provides wide output range from 1.8V up to 5.0V. The SGM2061 features ultra-low noise, high PSRR, low quiescent current and very good load/line transient performance. Due to low quiescent current the SGM2061 is suitable for battery-powered devices such as smartphones and tablets. The device is designed to work with a 1 μ F input and a 1 μ F output ceramic capacitors.

The SGM2061 is available in an ultra-thin Green WLCSP-0.64 \times 0.64-4B-A package. It operates over an operating temperature range of -40 $^{\circ}$ C to +125 $^{\circ}$ C.

APPLICATIONS

- Battery-Powered Equipment
- Smartphones and Tablets
- Digital Cameras
- Portable Medical Equipment
- RF, PLL, VCO and Clock Power Supplies

FEATURES

- **Operating Input Voltage Range: 1.9V to 5.5V**
- **Fixed Output Voltages:**
1.8V, 2.5V, 2.8V, 3.0V, 3.3V, 5.0V
- **Ultra-Low Noise: 10 μ V_{RMS} (TYP)**
- **Ultra-Low Quiescent Current: 15 μ A (TYP)**
- **Standby Current: 0.03 μ A (TYP)**
- **High PSRR: 98dB (TYP) at 1kHz**
- **Low Dropout Voltage:**
70mV (TYP) at 450mA when V_{OUT} = 2.8V
- **Output Short-Circuit Protection**
- **Over-Temperature Protection**
- **Stable with 1 μ F Small Case Size Ceramic Capacitors**
- **-40 $^{\circ}$ C to +125 $^{\circ}$ C Operating Temperature Range**
- **Available in an Ultra-Thin Green WLCSP-0.64 \times 0.64-4B-A Package**

TYPICAL APPLICATION

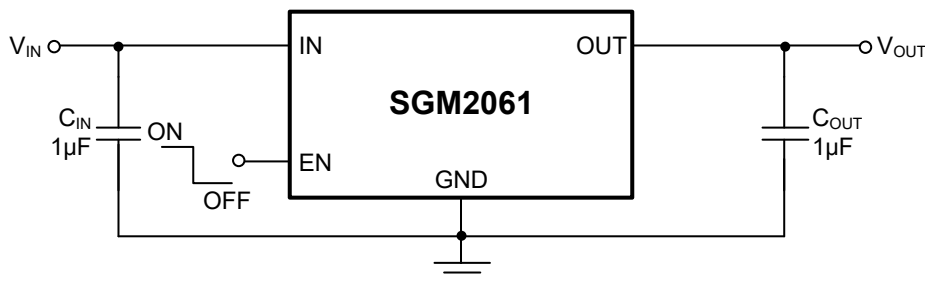
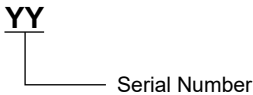

Figure 1. Typical Application Circuit

PACKAGE/ORDERING INFORMATION

MODEL	PACKAGE DESCRIPTION	SPECIFIED TEMPERATURE RANGE	ORDERING NUMBER	PACKAGE MARKING	PACKING OPTION
SGM2061-1.8	WLCSP-0.64×0.64-4B-A	-40°C to +125°C	SGM2061-1.8XG/TR	QF	Tape and Reel, 5000
SGM2061-2.5	WLCSP-0.64×0.64-4B-A	-40°C to +125°C	SGM2061-2.5XG/TR	R0	Tape and Reel, 5000
SGM2061-2.8	WLCSP-0.64×0.64-4B-A	-40°C to +125°C	SGM2061-2.8XG/TR	R1	Tape and Reel, 5000
SGM2061-3.0	WLCSP-0.64×0.64-4B-A	-40°C to +125°C	SGM2061-3.0XG/TR	R2	Tape and Reel, 5000
SGM2061-3.3	WLCSP-0.64×0.64-4B-A	-40°C to +125°C	SGM2061-3.3XG/TR	R3	Tape and Reel, 5000
SGM2061-5.0	WLCSP-0.64×0.64-4B-A	-40°C to +125°C	SGM2061-5.0XG/TR	R4	Tape and Reel, 5000

MARKING INFORMATION



Green (RoHS & HSF): SG Micro Corp defines "Green" to mean Pb-Free (RoHS compatible) and free of halogen substances. If you have additional comments or questions, please contact your SGMICRO representative directly.

ABSOLUTE MAXIMUM RATINGS

- IN to GND -0.3V to 6V
- OUT to GND -0.3V to (V_{IN} + 0.3V)
- EN to GND -0.3V to 6V
- Package Thermal Resistance
- WLCSP-0.64×0.64-4B-A, θ_{JA} 285°C/W
- WLCSP-0.64×0.64-4B-A, θ_{JB} 50°C/W
- WLCSP-0.64×0.64-4B-A, θ_{JC} 116°C/W
- Junction Temperature +150°C
- Storage Temperature Range -65°C to +150°C
- Lead Temperature (Soldering, 10s) +260°C
- ESD Susceptibility
- HBM 8000V
- CDM 1000V

RECOMMENDED OPERATING CONDITIONS

- Input Voltage Range 1.9V to 5.5V
- Enable Input Voltage Range 0V to 5.5V
- Input Effective Capacitance, C_{IN} 0.1µF (MIN)
- Output Effective Capacitance, C_{OUT} 0.5µF to 10µF
- Operating Junction Temperature Range -40°C to +125°C

OVERSTRESS CAUTION

Stresses beyond those listed in Absolute Maximum Ratings may cause permanent damage to the device. Exposure to absolute maximum rating conditions for extended periods may affect reliability. Functional operation of the device at any conditions beyond those indicated in the Recommended Operating Conditions section is not implied.

ESD SENSITIVITY CAUTION

This integrated circuit can be damaged if ESD protections are not considered carefully. SGMICRO recommends that all integrated circuits be handled with appropriate precautions. Failure to observe proper handling and installation procedures can cause damage. ESD damage can range from subtle performance degradation to complete device failure. Precision integrated circuits may be more susceptible to damage because even small parametric changes could cause the device not to meet the published specifications.

DISCLAIMER

SG Micro Corp reserves the right to make any change in circuit design, or specifications without prior notice.

PIN CONFIGURATION

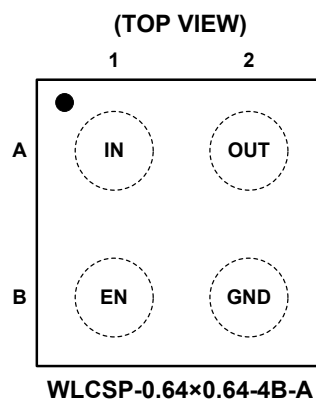

PIN DESCRIPTION

PIN	NAME	FUNCTION
A1	IN	Input Voltage Supply Pin. Bypass with a 1 μ F capacitor to GND.
A2	OUT	Regulated Output Voltage Pin. It is recommended to use an output capacitor with effective capacitance in the range of 0.5 μ F to 10 μ F. The capacitor should be located very close to this pin.
B1	EN	Enable Pin. Driving EN high to turn on the regulator. Driving EN low to turn off the regulator. For automatic startup, connect EN pin to IN pin.
B2	GND	Ground.

ELECTRICAL CHARACTERISTICS

($V_{IN} = V_{OUT(NOM)} + 1V$, $V_{EN} = V_{IN}$, $I_{OUT} = 1mA$, $C_{IN} = C_{OUT} = 1\mu F$, $T_J = -40^\circ C$ to $+125^\circ C$, typical values are at $T_J = +25^\circ C$, unless otherwise noted.)

PARAMETER	SYMBOL	CONDITIONS	MIN	TYP	MAX	UNITS
Operating Input Voltage	V_{IN}		1.9		5.5	V
Output Voltage Accuracy	V_{OUT}	$V_{IN} = (V_{OUT(NOM)} + 1V)$ to 5.5V, $I_{OUT} = 1mA$ to 450mA, $T_J = +25^\circ C$	-1		1	%
		$V_{IN} = (V_{OUT(NOM)} + 1V)$ to 5.5V, $I_{OUT} = 1mA$ to 450mA	-2.5		2.5	
Line Regulation	ΔV_{LNR}	$V_{IN} = (V_{OUT(NOM)} + 1V)$ to 5.5V		0.05	2	mV
Load Regulation	$\Delta V_{LDR}/V_{OUT}$	$I_{OUT} = 1mA$ to 450mA		0.4	5	mV/V
Dropout Voltage ⁽¹⁾	V_{DROP}	$I_{OUT} = 450mA$, $V_{OUT(NOM)} = 2.8V$		70	130	mV
Output Current Limit	I_{LIMIT}	$V_{OUT} = 90\% \times V_{OUT(NOM)}$	$T_J = -20^\circ C$ to $+125^\circ C$	450	900	mA
			$T_J = -40^\circ C$ to $+125^\circ C$	400	900	
Short-Circuit Current	I_{SHORT}	$V_{OUT} = 0V$		500		mA
Quiescent Current	I_Q	$I_{OUT} = 0mA$		15	40	μA
Shutdown Current	I_{SHDN}	$V_{EN} = 0V$, $V_{IN} = 5.5V$		0.03	2	μA
EN Pin Threshold Voltage	V_{IH}	$V_{IN} = 1.9V$ to 5.5V	1			V
	V_{IL}	$V_{IN} = 1.9V$ to 5.5V			0.6	
EN Pull-Down Current	I_{EN}	$V_{EN} = 0V$, $V_{IN} = 5.5V$		0.001	1	μA
		$V_{EN} = 5.5V$, $V_{IN} = 5.5V$		0.2	1	
Turn-On Time	t_{ON}	From assertion of V_{EN} to $V_{OUT} = 90\% \times V_{OUT(NOM)}$		100	240	μs
Power Supply Rejection Ratio	PSRR	$I_{OUT} = 20mA$, $V_{IN} = V_{OUT(NOM)} + 1V$	$f = 100Hz$		91	dB
			$f = 1kHz$		98	
			$f = 10kHz$		82	
			$f = 100kHz$		48	
Output Voltage Noise	e_n	$f = 10Hz$ to 100kHz	$I_{OUT} = 1mA$		10	μV_{RMS}
			$I_{OUT} = 250mA$		9	
Output Discharge Resistance	R_{DIS}	$V_{EN} = 0V$, $V_{OUT} = 0.2V$, $V_{IN} = 3.3V$		270		Ω
Thermal Shutdown Temperature	T_{SHDN}			160		$^\circ C$
Thermal Shutdown Hysteresis	ΔT_{SHDN}			20		$^\circ C$

NOTE:

1. Dropout voltage is characterized when V_{OUT} falls 50mV below $V_{OUT(NOM)}$.

TYPICAL PERFORMANCE CHARACTERISTICS

$T_J = +25^\circ\text{C}$, $V_{IN} = V_{OUT(NOM)} + 1\text{V}$, $V_{EN} = V_{IN}$, $C_{IN} = C_{OUT} = 1\mu\text{F}$, unless otherwise noted.

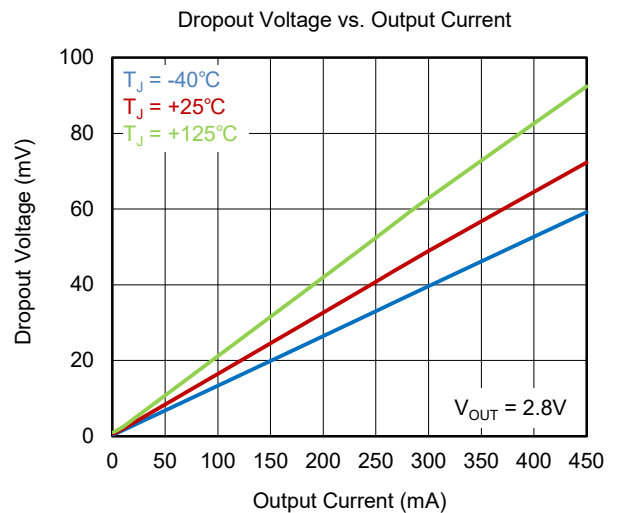
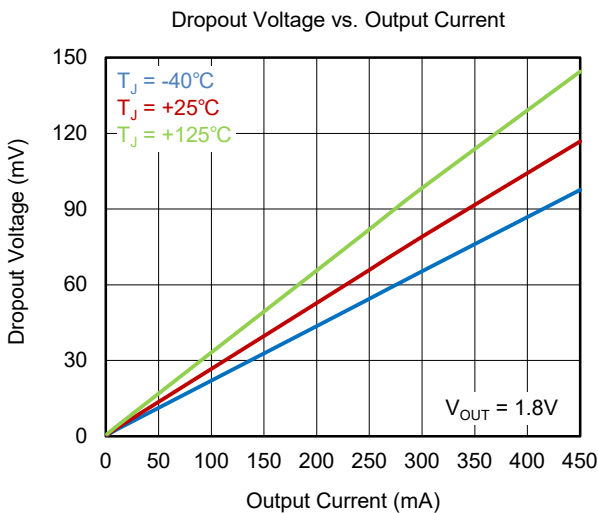
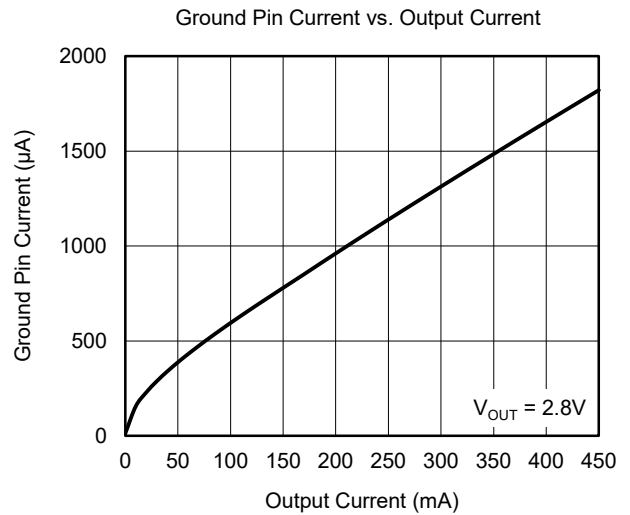
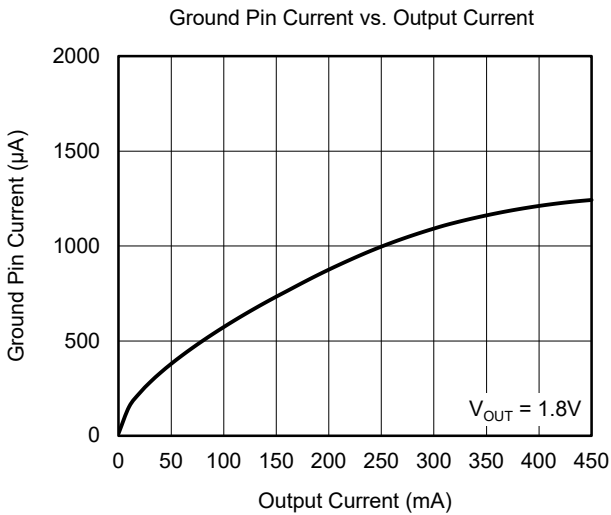
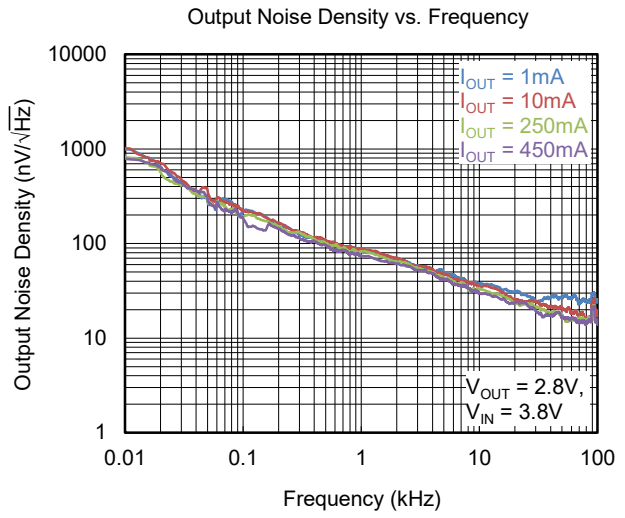
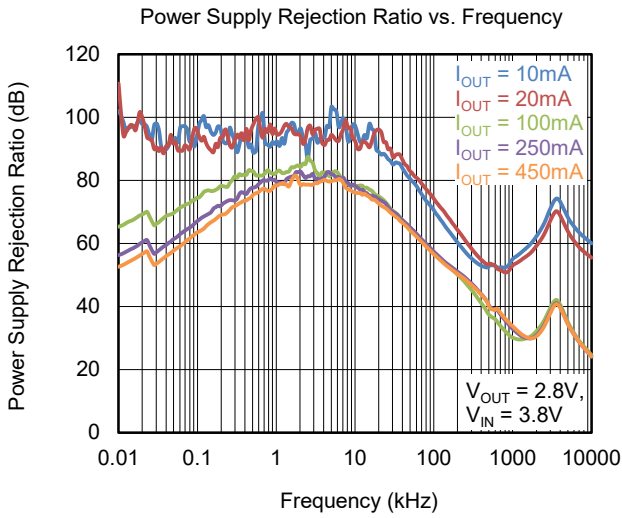

TYPICAL PERFORMANCE CHARACTERISTICS (continued)

$T_J = +25^\circ\text{C}$, $V_{IN} = V_{OUT(NOM)} + 1\text{V}$, $V_{EN} = V_{IN}$, $C_{IN} = C_{OUT} = 1\mu\text{F}$, unless otherwise noted.

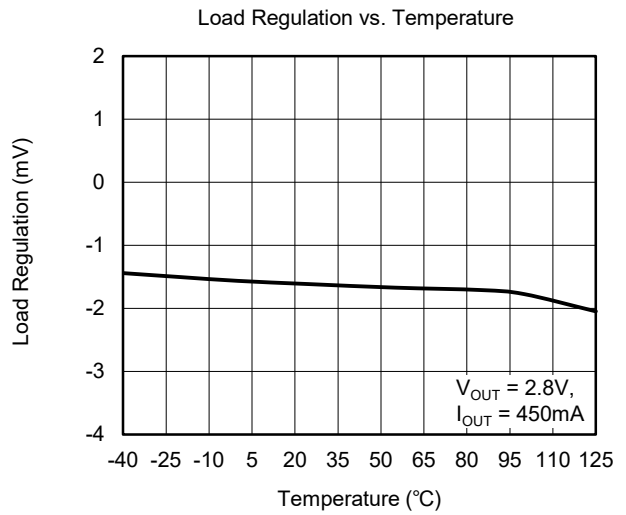
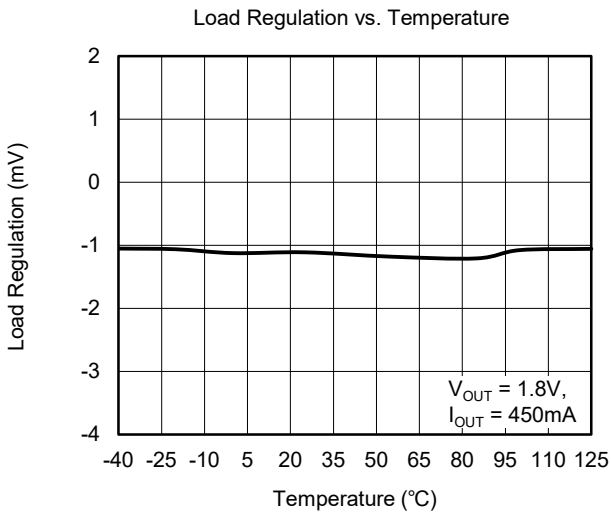
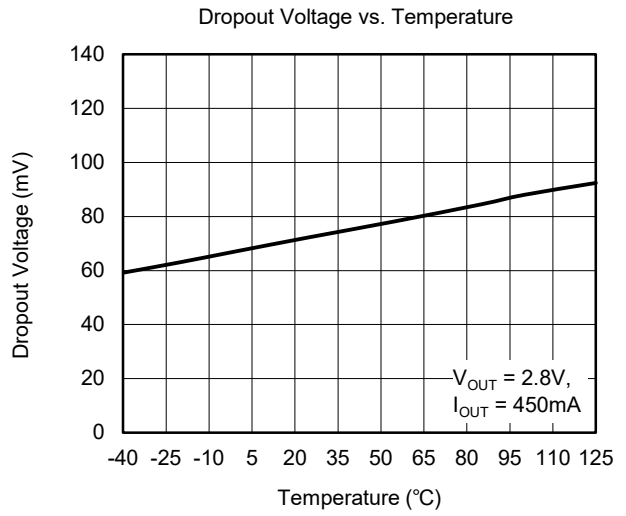
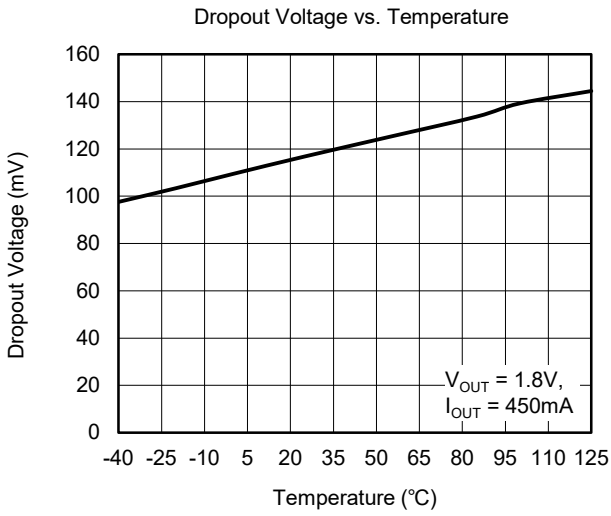

TYPICAL PERFORMANCE CHARACTERISTICS (continued)

$T_J = +25^\circ\text{C}$, $V_{IN} = V_{OUT(NOM)} + 1\text{V}$, $V_{EN} = V_{IN}$, $C_{IN} = C_{OUT} = 1\mu\text{F}$, unless otherwise noted.

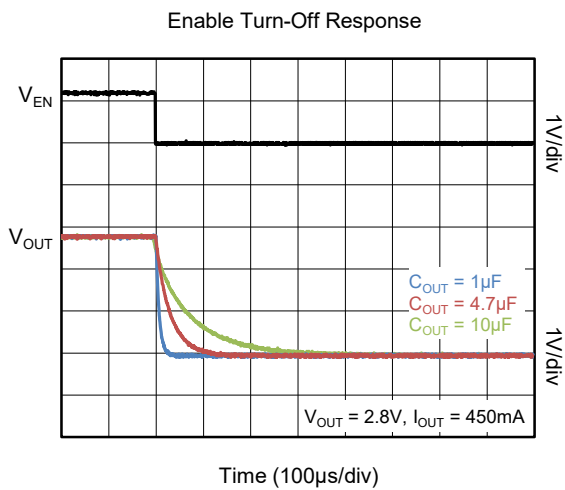
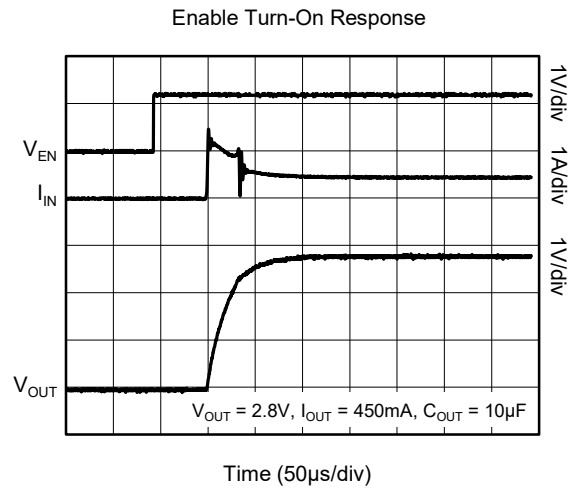
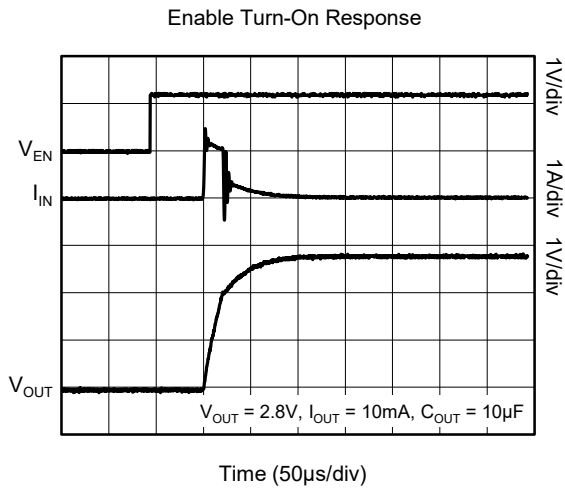
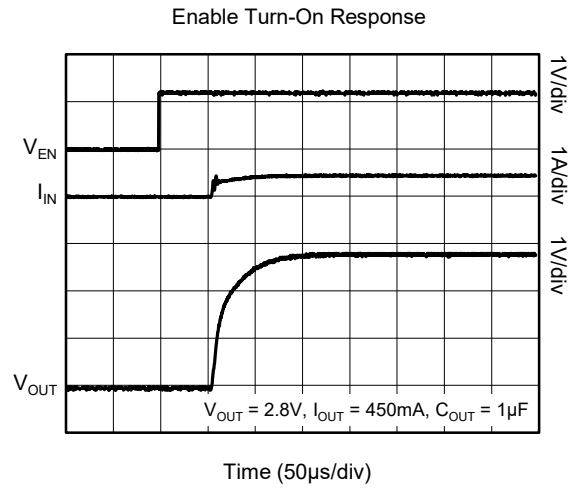
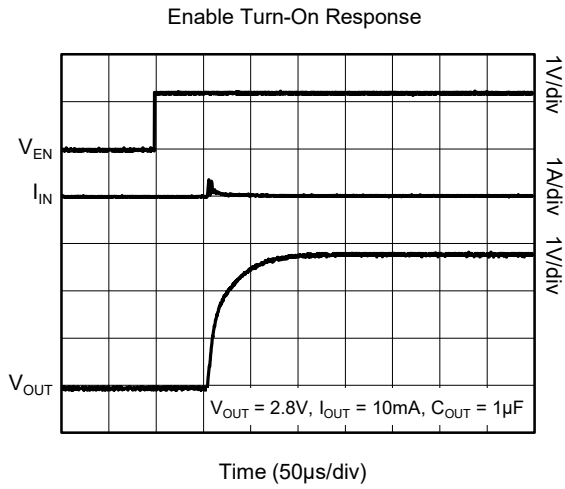

TYPICAL PERFORMANCE CHARACTERISTICS (continued)

$T_J = +25^\circ\text{C}$, $V_{IN} = V_{OUT(NOM)} + 1\text{V}$, $V_{EN} = V_{IN}$, $C_{IN} = C_{OUT} = 1\mu\text{F}$, unless otherwise noted.

Line Transient Response

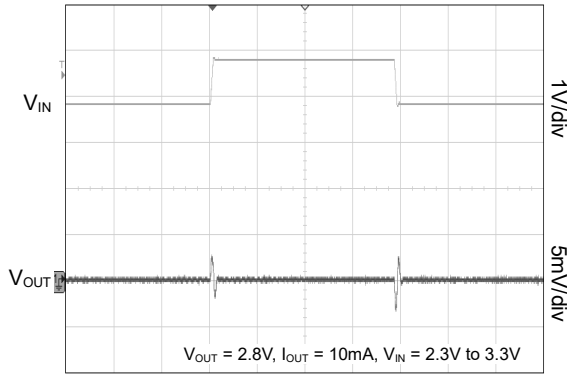

Time (20µs/div)

Line Transient Response

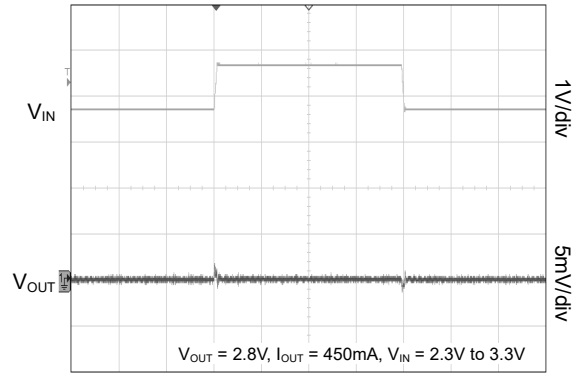

Time (20µs/div)

Load Transient Response

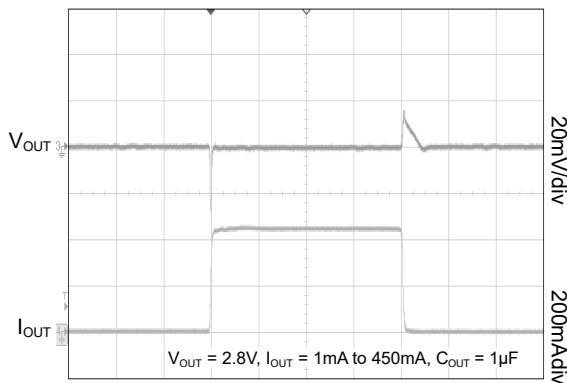

Time (20µs/div)

Load Transient Response

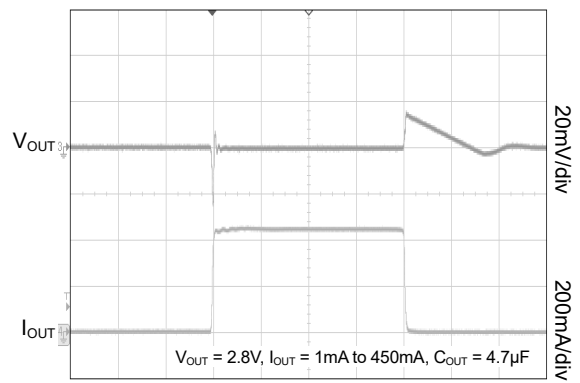

Time (20µs/div)

FUNCTIONAL BLOCK DIAGRAM

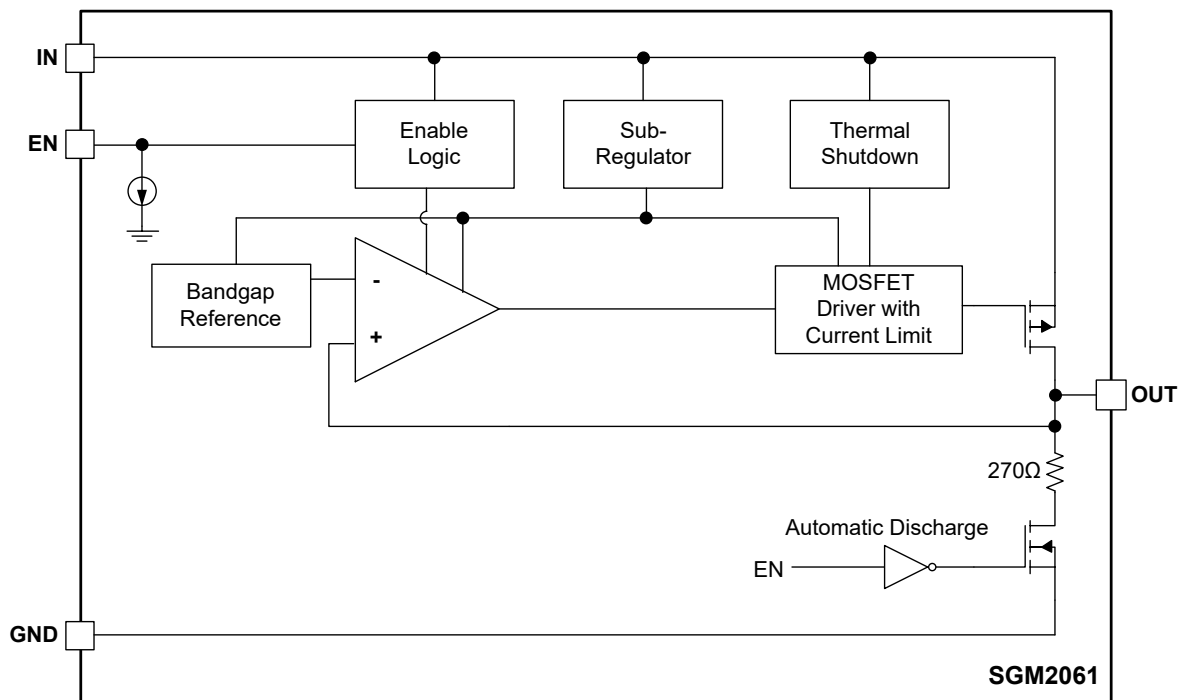

Figure 2. Block Diagram

APPLICATION INFORMATION

The SGM2061 is a 450mA, ultra-low noise and low dropout regulator designed to meet the requirements of low voltage RF applications and high performance analog circuits. The SGM2061 device provides very high PSRR and excellent dynamic response. In connection with low quiescent current this device is well suitable for battery-powered applications such as cell phones, tablets and etc. The SGM2061 is fully protected in case of current overload, output short-circuit and overheating.

Input Capacitor Selection (C_{IN})

The input capacitor is necessary to be connected as close as possible for ensuring the device stability. The X7R or X5R capacitor should be used for reliable performance over temperature range. The value of the input capacitor should be $0.1\mu\text{F}$ or greater to ensure the best dynamic performance. This capacitor will provide a low impedance path for unwanted AC signals or noise modulated onto constant input voltage. There is no requirement for the ESR of the input capacitor, but it is recommended to use ceramic capacitors for their low ESR and ESL. A good input capacitor will limit the influence of input trace inductance and source resistance during sudden load current changes.

Enable Operation

The SGM2061 uses the EN pin to enable/disable its device and to deactivate/activate the output automatic discharge function.

If the EN pin voltage is lower than 0.6V , the device is guaranteed to be disabled. The pass transistor is turned off so that there is virtually no current flow between the IN and OUT pins. The output automatic discharge transistor is active so that the output voltage V_{OUT} is pulled to GND through a 270Ω resistor. In the disable state, the device consumes as low as $0.03\mu\text{A}$ (TYP) from the V_{IN} .

If the EN pin voltage is higher than 1V , the device is guaranteed to be enabled. The SGM2061 regulates the output voltage and the output automatic discharge transistor is turned off.

The EN pin has an internal pull-down current source with a typical value of $0.001\mu\text{A}$ which ensures that the device is turned off when the EN pin is not connected. In the case where the EN function isn't required, the EN pin should be tied directly to the IN pin.

Output Current Limit

Output current is internally limited within the IC to a 900mA (TYP). The SGM2061 will source this amount of current measured with a voltage drop on the 90% of the nominal V_{OUT} . If the output voltage is directly shorted to ground ($V_{OUT} = 0\text{V}$), the short-circuit protection will limit the output current to 500mA (TYP). The current limit and short-circuit protection will work properly over whole temperature range and also input voltage range. There is no limitation for the short-circuit duration.

Power Dissipation

As power dissipated in the SGM2061 increases, it might become necessary to provide some thermal relief. The maximum power dissipation supported by the device is dependent upon board design and layout. Mounting pad configuration on the PCB, the board material and the ambient temperature affect the junction temperature rise rate of the part.

Reverse Current

The PMOS pass transistor has an inherent body diode which will be forward biased in the case that $V_{OUT} > V_{IN}$. Due to this fact, in cases where the extended reverse current condition can be anticipated the device may require additional external protection.

Power Supply Rejection Ratio

The SGM2061 provides very high power supply rejection ratio. If desired, the PSRR at higher frequencies in the range from 100kHz to 10MHz can be tuned by the selection of C_{OUT} capacitor and proper PCB layout.

Turn-On Time

The turn-on time is defined as the time period from EN assertion to the point in which V_{OUT} will reach 90% of its nominal value.

PCB Layout Recommendations

To obtain good transient performance and good regulation characteristics, place input and output capacitors close to the device pins and make the PCB traces wide. In order to minimize the solution size, use 0402 or 0201 capacitors with appropriate capacity. Larger copper area connected to the pins will also improve the device thermal resistance.

REVISION HISTORY

NOTE: Page numbers for previous revisions may differ from page numbers in the current version.

Changes from Original (SEPTEMBER 2021) to REV.A

Page

Changed from product preview to production data.....All

PACKAGE OUTLINE DIMENSIONS

WLCSP-0.64x0.64-4B-A

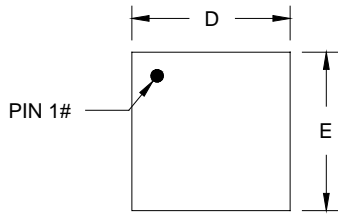

TOP VIEW

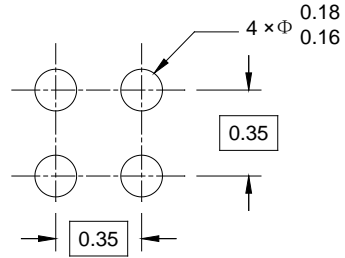

RECOMMENDED LAND PATTERN (Unit: mm)

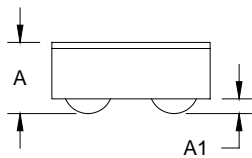

SIDE VIEW

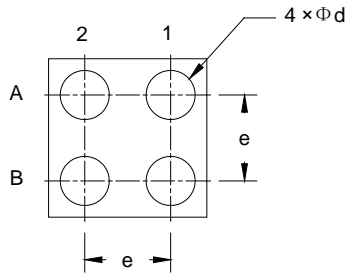

BOTTOM VIEW

Symbol	Dimensions In Millimeters		
	MIN	MOD	MAX
A	0.262	0.290	0.318
A1	0.050	0.060	0.070
D	0.620	0.645	0.670
E	0.620	0.645	0.670
d	0.190	0.200	0.210
e	0.350 BSC		

NOTE: This drawing is subject to change without notice.

PACKAGE INFORMATION

TAPE AND REEL INFORMATION

REEL DIMENSIONS



TAPE DIMENSIONS



NOTE: The picture is only for reference. Please make the object as the standard.

KEY PARAMETER LIST OF TAPE AND REEL

Package Type	Reel Diameter	Reel Width W1 (mm)	A0 (mm)	B0 (mm)	K0 (mm)	P0 (mm)	P1 (mm)	P2 (mm)	W (mm)	Pin1 Quadrant
WLCSP-0.64×0.64-4B-A	7"	9.5	0.74	0.74	0.37	4.0	4.0	2.0	8.0	Q1

DD0001

PACKAGE INFORMATION

CARTON BOX DIMENSIONS



NOTE: The picture is only for reference. Please make the object as the standard.

KEY PARAMETER LIST OF CARTON BOX

Reel Type	Length (mm)	Width (mm)	Height (mm)	Pizza/Carton
7" (Option)	368	227	224	8
7"	442	410	224	18

DD0002