

GENERAL DESCRIPTION

The SGM2037S is a 600mA, low noise and very low dropout voltage CMOS voltage regulator equipped with NMOS pass transistor and a separate bias supply voltage (V_{BIAS}). The device provides very stable, accurate output voltage with low noise suitable for space constrained and noise sensitive applications. In order to optimize performance for battery operated portable applications, the SGM2037S features low current consumption.

The SGM2037S is available in a Green UTDFN-1.2×1.2-6L package. It operates over an ambient temperature range of -40°C to +125°C.

FEATURES

- **Input Voltage Range: 0.9V to 5.5V**
- **Bias Voltage Range: 2.5V to 5.5V**
- **0.9V Fixed Output Voltage**
- **Fast Load Transient Response**
- **600mA Nominal Output Current**
- **Low Dropout: 140mV (TYP) at 600mA**
- **Very Low Bias Input Current: 98µA (TYP)**
- **Very Low Bias Input Current in Shutdown: 0.01µA (TYP)**
- **Low Noise: 20µV_{RMS} (TYP)**
- **Over-Current and Over-Temperature Protections**
- **Logic Level Enable Input for ON/OFF Control**
- **-40°C to +125°C Operating Temperature Range**
- **Available in a Green UTDFN-1.2×1.2-6L Package**

APPLICATIONS

- Battery-Powered Equipment
- Smartphones and Tablets
- Cameras, DVRs, STB and Camcorders

TYPICAL APPLICATION

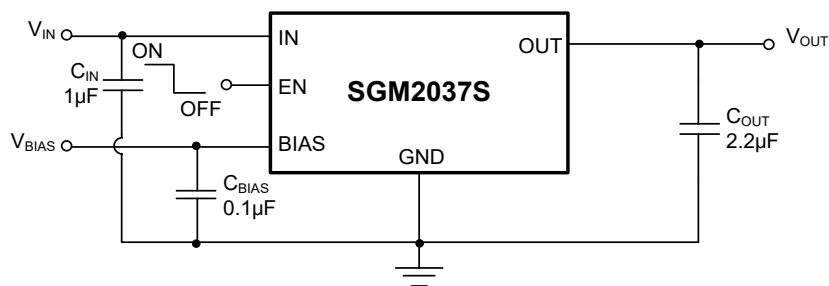

Figure 1. Typical Application Circuit

PACKAGE/ORDERING INFORMATION

MODEL	PACKAGE DESCRIPTION	SPECIFIED TEMPERATURE RANGE	ORDERING NUMBER	PACKAGE MARKING	PACKING OPTION
SGM2037S-0.9	UTDFN-1.2x1.2-6L	-40°C to +125°C	SGM2037S-0.9XUDX6G/TR	4B XX	Tape and Reel, 5000

MARKING INFORMATION

NOTE: XX = Date Code.

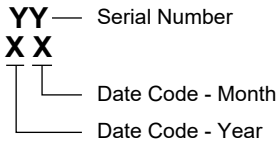

Green (RoHS & HSF): SG Micro Corp defines "Green" to mean Pb-Free (RoHS compatible) and free of halogen substances. If you have additional comments or questions, please contact your SGMICRO representative directly.

ABSOLUTE MAXIMUM RATINGS

- IN, BIAS, EN to GND -0.3V to 6V
- OUT to GND -0.3V to (V_{IN} + 0.3V)
- Power Dissipation, P_D @ T_A = +25°C
- UTDFN-1.2x1.2-6L 612mW
- Package Thermal Resistance
- UTDFN-1.2x1.2-6L, θ_{JA} 204°C/W
- Junction Temperature +150°C
- Storage Temperature Range..... -65°C to +150°C
- Lead Temperature (Soldering, 10s) +260°C
- ESD Susceptibility
- HBM..... 8000V
- CDM 1000V

RECOMMENDED OPERATING CONDITIONS

- Operating Input Voltage Range0.9V to 5.5V
- Operating Bias Voltage Range2.5V to 5.5V
- Operating Temperature Range-40°C to +125°C

OVERSTRESS CAUTION

Stresses beyond those listed in Absolute Maximum Ratings may cause permanent damage to the device. Exposure to absolute maximum rating conditions for extended periods may affect reliability. Functional operation of the device at any conditions beyond those indicated in the Recommended Operating Conditions section is not implied.

ESD SENSITIVITY CAUTION

This integrated circuit can be damaged by ESD if you don't pay attention to ESD protection. SGMICRO recommends that all integrated circuits be handled with appropriate precautions. Failure to observe proper handling and installation procedures can cause damage. ESD damage can range from subtle performance degradation to complete device failure. Precision integrated circuits may be more susceptible to damage because very small parametric changes could cause the device not to meet its published specifications.

DISCLAIMER

SG Micro Corp reserves the right to make any change in circuit design, or specifications without prior notice.

PIN CONFIGURATION

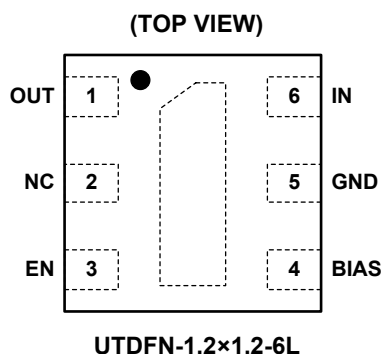

PIN DESCRIPTION

PIN	NAME	FUNCTION
1	OUT	Regulated Output Voltage Pin. It is recommended to use output capacitor with effective capacitance in the range of 1 μ F to 10 μ F.
2	NC	Not Connected.
3	EN	Enable Pin. Driving this pin high enables the regulator. Driving this pin low puts the regulator into shutdown mode.
4	BIAS	Bias Voltage Supply for Internal Control Circuits. This pin is monitored by internal under-voltage lockout circuit.
5	GND	Ground.
6	IN	Input Voltage Supply Pin.
Exposed Pad	–	Exposed Pad. The exposed pad should be connected to a large ground plane to maximize thermal performance.

ELECTRICAL CHARACTERISTICS

($V_{IN} = 1.2V$, $V_{EN} = V_{BIAS} = 2.7V$, $I_{OUT} = 1mA$, $C_{IN} = 1\mu F$, $C_{BIAS} = 0.1\mu F$ and $C_{OUT} = 2.2\mu F$, Full = $-40^{\circ}C$ to $+125^{\circ}C$, unless otherwise noted.)

PARAMETER	SYMBOL	CONDITIONS	TEMP	MIN	TYP	MAX	UNITS
Operating Input Voltage Range	V_{IN}		+25°C	0.9		5.5	V
Operating Bias Voltage Range	V_{BIAS}		+25°C	2.5		5.5	V
Under-Voltage Lockout Thresholds	V_{UVLO}	V_{BIAS} rising	+25°C		1.6		V
		Hysteresis	+25°C		0.2		
Output Voltage Accuracy	V_{OUT}	$V_{IN} = 1.2V$ to $1.9V$, $V_{BIAS} = 2.7V$ to $5.5V$, $I_{OUT} = 1mA$ to $600mA$	+25°C	-0.8		0.8	%
			Full	-1.5		1.5	
V_{IN} Line Regulation	$\frac{\Delta V_{OUT}}{\Delta V_{IN} \times V_{OUT}}$	$V_{IN} = 1.2V$ to $5.5V$	+25°C		0.002	0.03	%/V
V_{BIAS} Line Regulation	$\frac{\Delta V_{OUT}}{\Delta V_{BIAS} \times V_{OUT}}$	$V_{BIAS} = 2.7V$ to $5.5V$	+25°C		0.002	0.03	%/V
Load Regulation	ΔV_{OUT}	$I_{OUT} = 1mA$ to $600mA$	+25°C		0.5	2	mV
V_{IN} Dropout Voltage ⁽¹⁾	V_{DROP_IN}	$I_{OUT} = 150mA$	+25°C		35	50	mV
		$I_{OUT} = 600mA$	+25°C		140	200	
Output Current Limit	I_{LIM}		+25°C	1000	1400		mA
Short Current Limit	I_{SHORT}	$V_{OUT} = 0V$	+25°C		400		mA
BIAS Pin Operating Current	I_{BIAS}	$V_{BIAS} = 5.5V$	+25°C		98	130	μA
			Full			145	
BIAS Pin Disable Current	I_{DIS_BIAS}	$V_{EN} = 0V$	+25°C		0.01	0.5	μA
			Full			2.5	
IN Pin Disable Current	I_{DIS_IN}	$V_{EN} = 0V$	+25°C		0.05	0.5	μA
			Full			1.6	
EN Pin Threshold Voltage	V_{IH}	EN input voltage high	Full	1.2			V
	V_{IL}	EN input voltage low	Full			0.25	
EN Pin Pull-Down Resistance	R_{EN}		+25°C		580		k Ω
Turn-On Time	t_{ON}	From assertion of V_{EN} to $V_{OUT} = 90\%V_{OUT(NOM)}$	+25°C		100		μs
V_{IN} Power Supply Rejection Ratio	PSRR	V_{IN} to V_{OUT} , $f = 1kHz$, $I_{OUT} = 150mA$, $V_{IN} \geq 1.4V$	+25°C		76		dB
V_{BIAS} Power Supply Rejection Ratio		V_{BIAS} to V_{OUT} , $f = 1kHz$, $I_{OUT} = 150mA$, $V_{IN} \geq 1.4V$	+25°C		76		
Output Voltage Noise	e_n	$V_{IN} = 1.4V$, $f = 10Hz$ to $100kHz$	+25°C		20		μV_{RMS}
Output Discharge Resistance	R_{DISCH}	$V_{EN} = 0V$, $V_{OUT} = 0.5V$	+25°C		120		Ω
Thermal Shutdown Temperature	T_{SHDN}				160		$^{\circ}C$
Thermal Shutdown Hysteresis	ΔT_{SHDN}				20		$^{\circ}C$

NOTE:

1. Dropout voltage is characterized when V_{OUT} falls 5% below $V_{OUT(NOM)}$.

TYPICAL PERFORMANCE CHARACTERISTICS

$T_A = +25^\circ\text{C}$, $V_{IN} = 1.2\text{V}$, $V_{EN} = V_{BIAS} = 2.7\text{V}$, $V_{OUT(NOM)} = 0.9\text{V}$, $C_{IN} = 1\mu\text{F}$, $C_{BIAS} = 0.1\mu\text{F}$ and $C_{OUT} = 2.2\mu\text{F}$, unless otherwise noted.

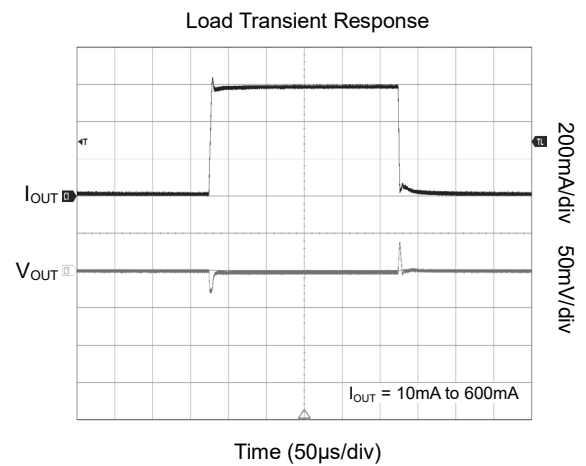
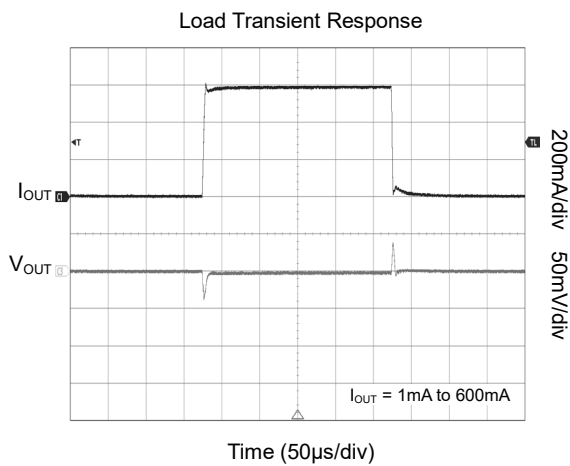
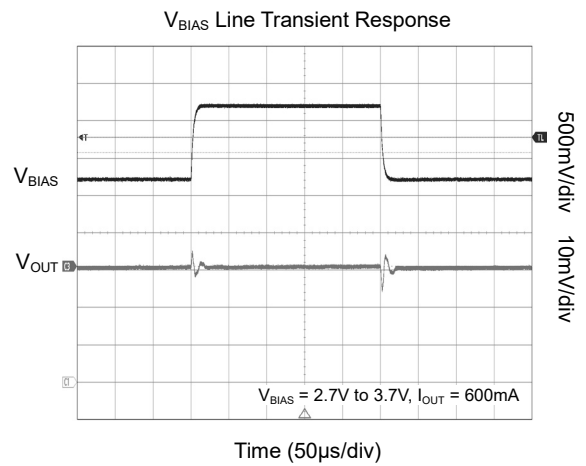
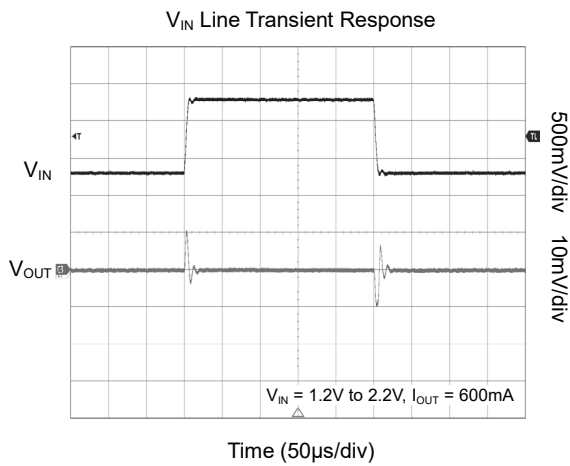
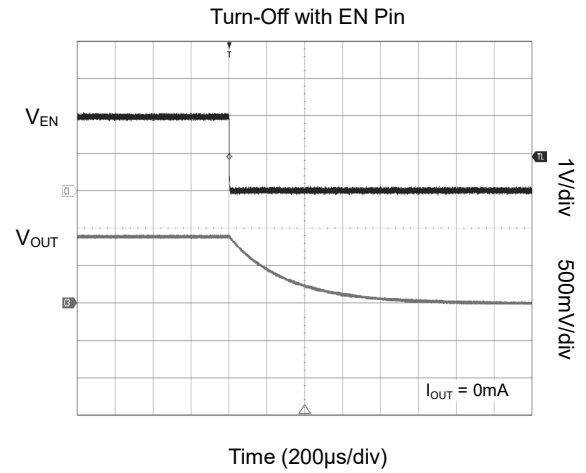
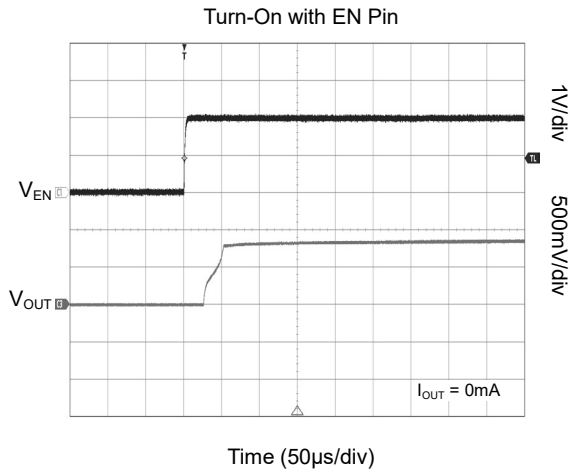

TYPICAL PERFORMANCE CHARACTERISTICS (continued)

$T_A = +25^\circ\text{C}$, $V_{IN} = 1.2\text{V}$, $V_{EN} = V_{BIAS} = 2.7\text{V}$, $V_{OUT(NOM)} = 0.9\text{V}$, $C_{IN} = 1\mu\text{F}$, $C_{BIAS} = 0.1\mu\text{F}$ and $C_{OUT} = 2.2\mu\text{F}$, unless otherwise noted.

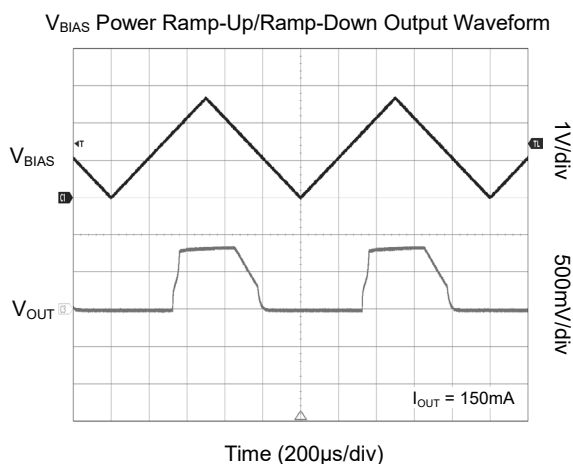
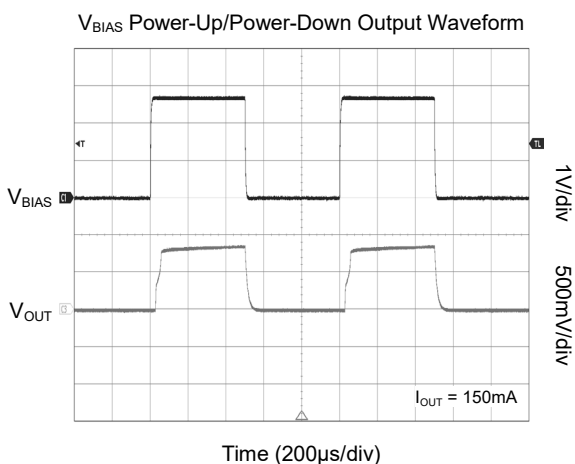
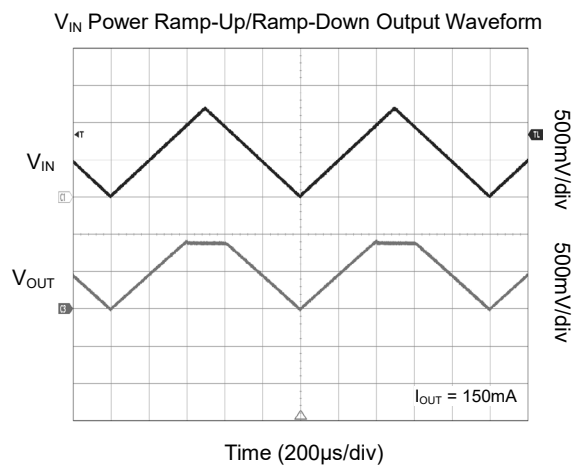
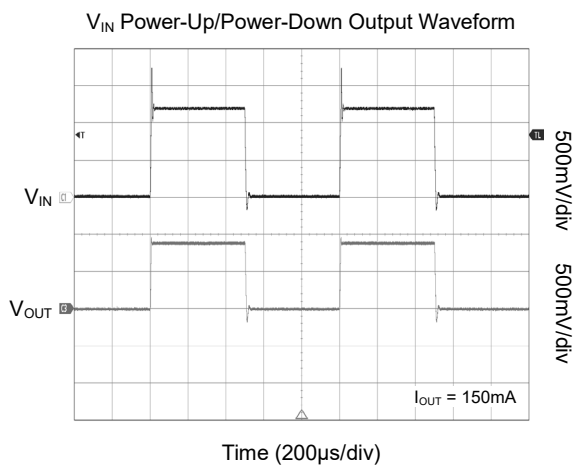

TYPICAL PERFORMANCE CHARACTERISTICS (continued)

T_A = +25°C, V_{IN} = 1.2V, V_{EN} = V_{BIAS} = 2.7V, V_{OUT(NOM)} = 0.9V, C_{IN} = 1μF, C_{BIAS} = 0.1μF and C_{OUT} = 2.2μF, unless otherwise noted.

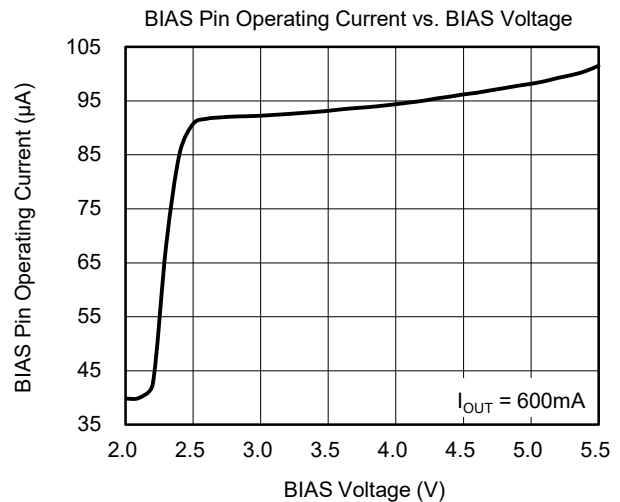
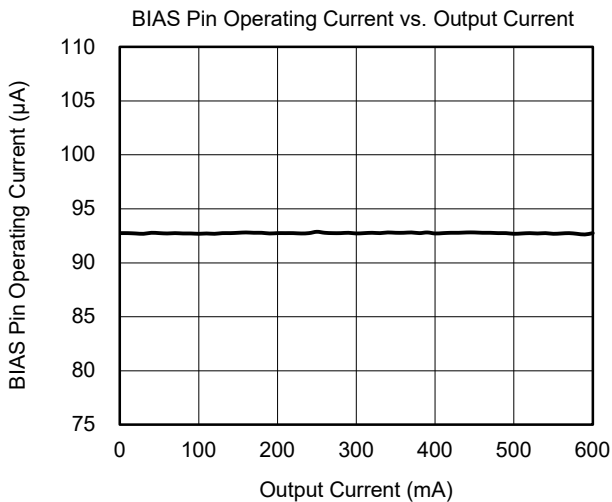
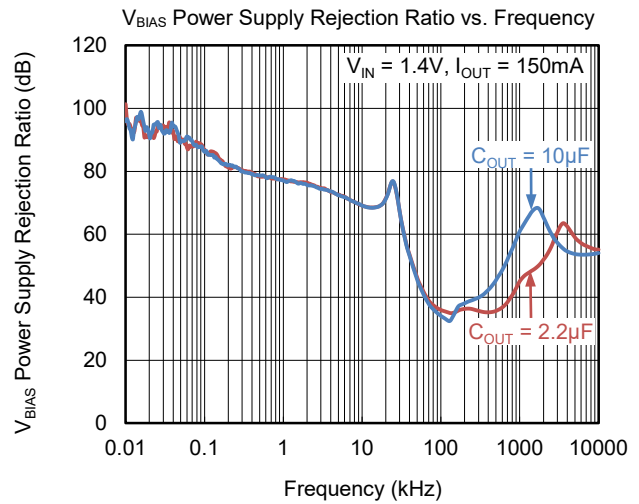
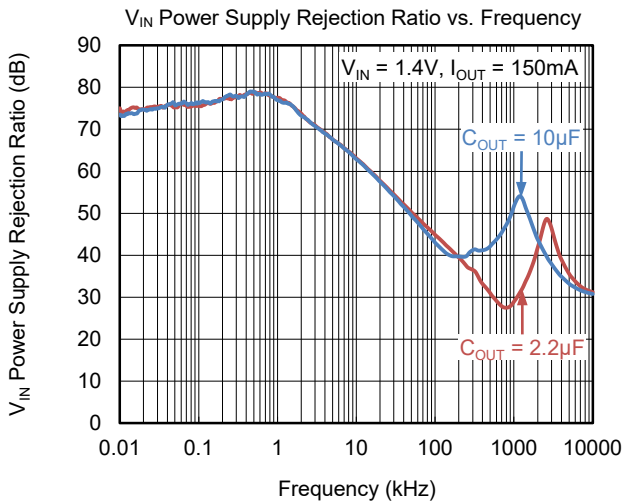
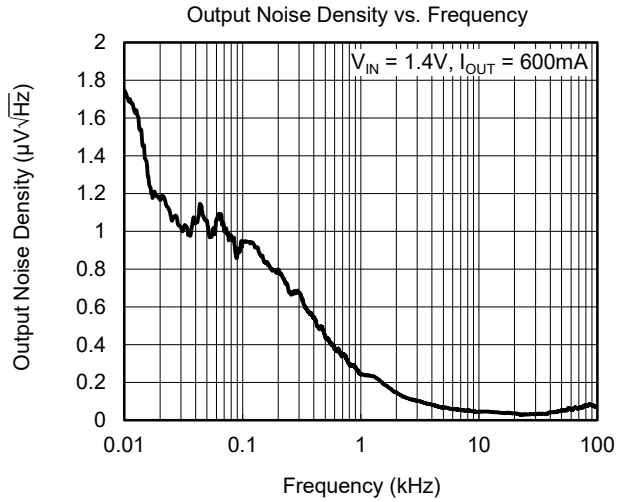
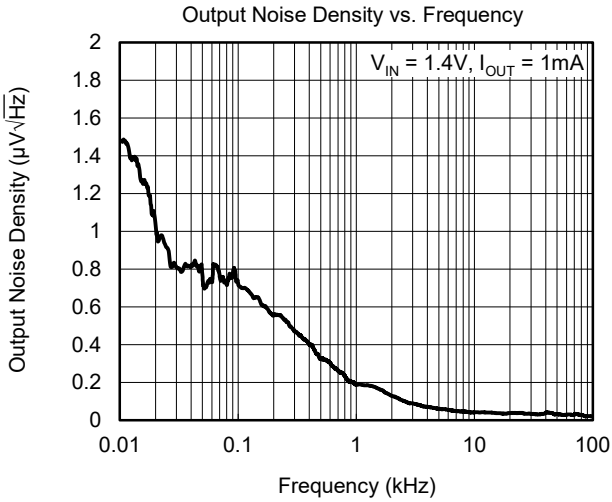

TYPICAL PERFORMANCE CHARACTERISTICS (continued)

$T_A = +25^\circ\text{C}$, $V_{IN} = 1.2\text{V}$, $V_{EN} = V_{BIAS} = 2.7\text{V}$, $V_{OUT(NOM)} = 0.9\text{V}$, $C_{IN} = 1\mu\text{F}$, $C_{BIAS} = 0.1\mu\text{F}$ and $C_{OUT} = 2.2\mu\text{F}$, unless otherwise noted.

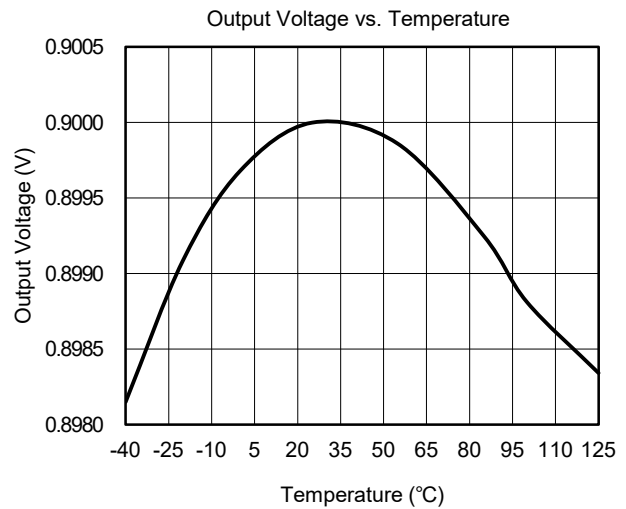
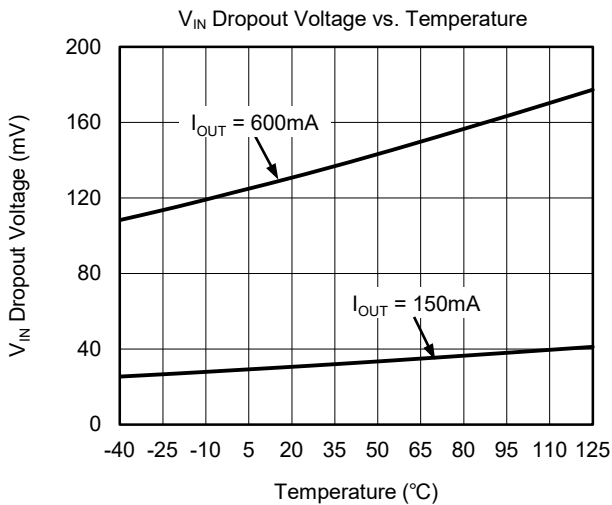
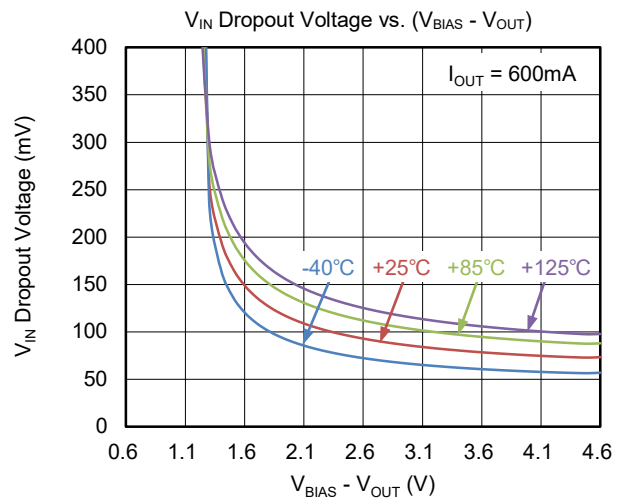
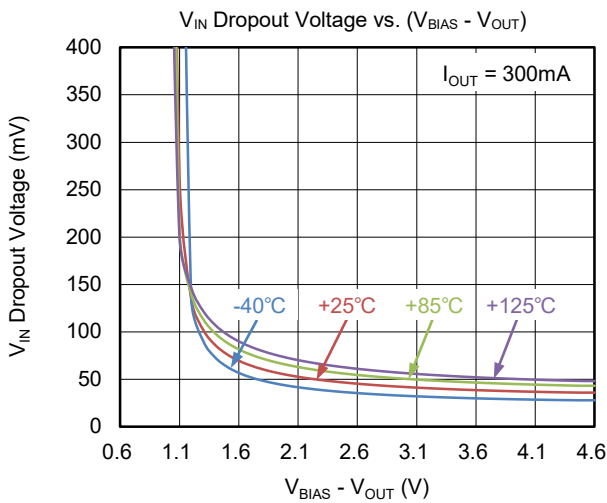
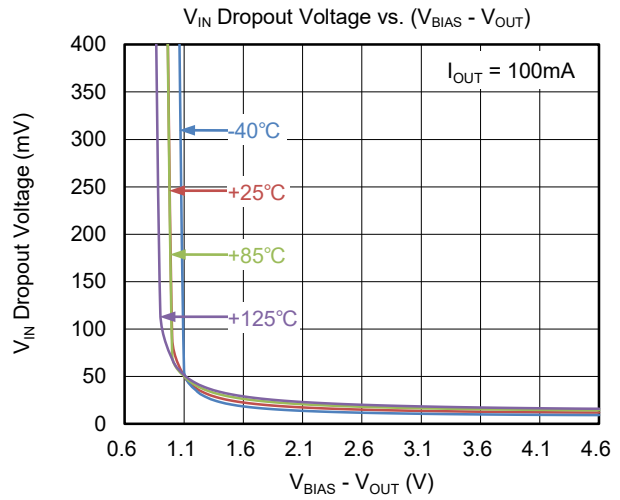
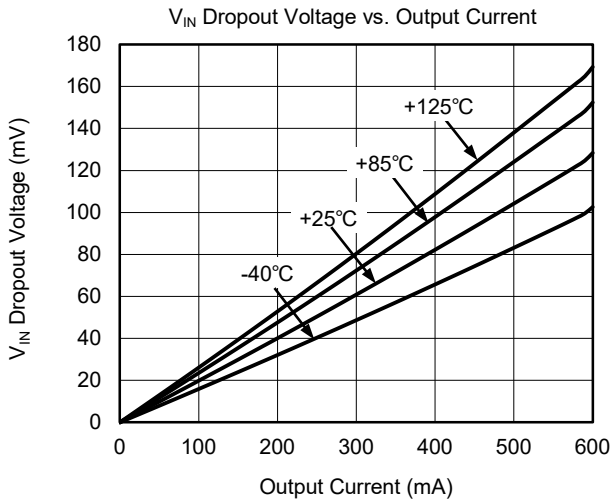

FUNCTIONAL BLOCK DIAGRAM

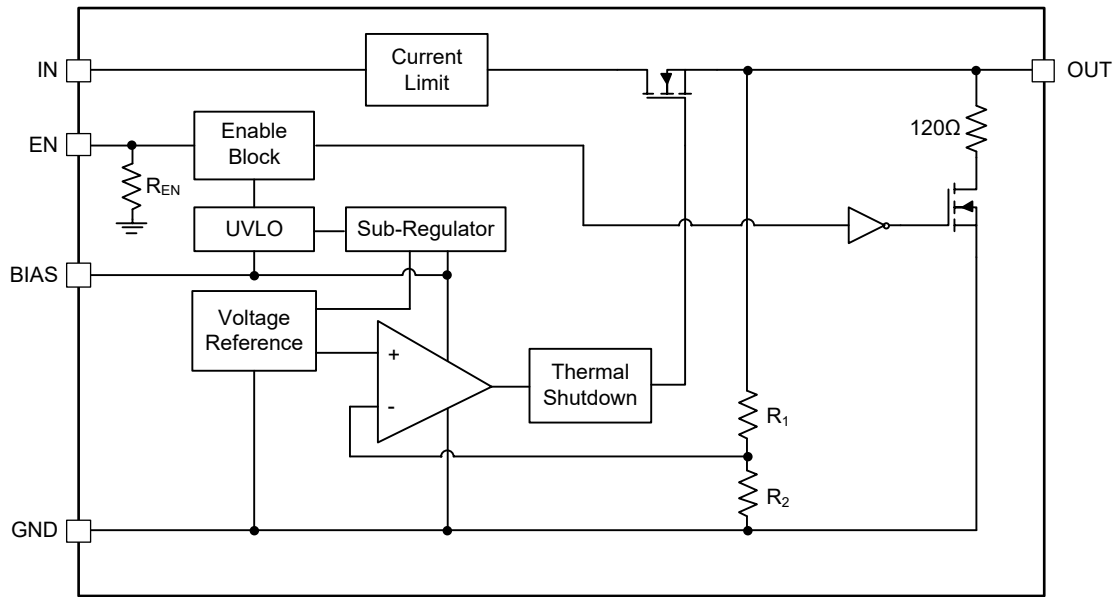

Figure 2. Block Diagram

TYPICAL APPLICATION CIRCUIT

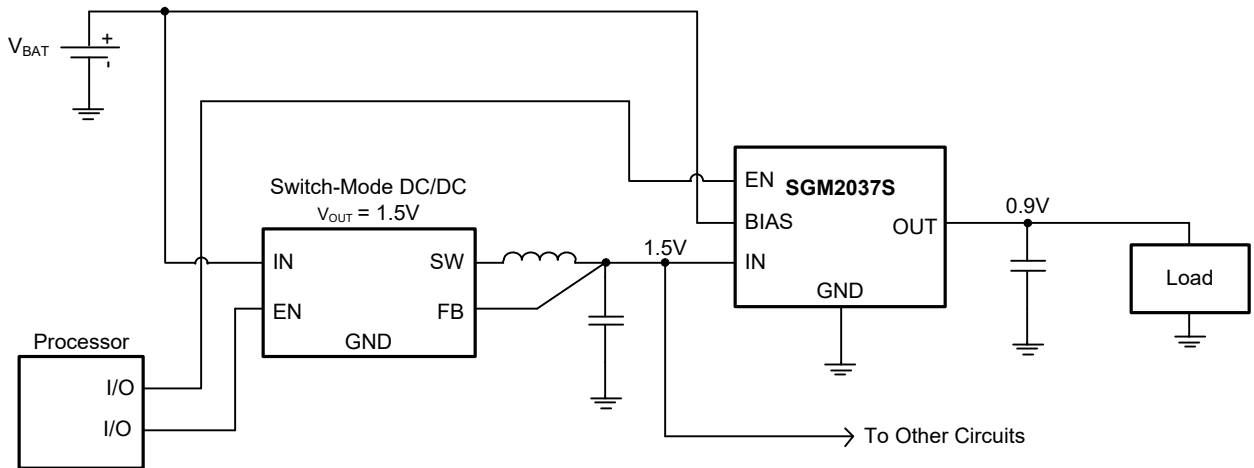

Figure 3. Used as DC/DC Post Regulator

APPLICATION INFORMATION

The SGM2037S dual-rail very low dropout voltage regulator is using NMOS pass transistor for output voltage regulation from V_{IN} voltage. All the low current internal control circuitry is powered from the V_{BIAS} voltage.

The use of an NMOS pass transistor offers several advantages in applications. Unlike PMOS topology devices, the output capacitor has reduced impact on loop stability. V_{IN} to V_{OUT} operating voltage difference can be very low compared with standard PMOS regulators in very low V_{IN} applications.

The SGM2037S offers smooth monotonic start-up. The controlled voltage rising limits the inrush current.

The enable (EN) input is equipped with internal hysteresis.

Dropout Voltage

Because of two power supplies V_{IN} and V_{BIAS} and one V_{OUT} regulator output, there are two dropout voltages specified.

The first, the V_{IN} dropout voltage is the voltage difference ($V_{IN} - V_{OUT}$) when V_{OUT} starts to decrease by the percentage specified in the Electrical Characteristics table. V_{BIAS} is high enough; specific value is published in the Electrical Characteristics table.

The second, V_{BIAS} dropout voltage is the voltage difference ($V_{BIAS} - V_{OUT}$) when IN and BIAS pins are joined together and V_{OUT} starts to decrease.

Input and Output Capacitors

The device is designed to be stable for ceramic output capacitors with effective capacitance in the range from $1\mu\text{F}$ to $10\mu\text{F}$. The device is also stable with multiple capacitors in parallel, having the total effective capacitance in the specified range.

In applications where no low impedance input supplies available (PCB inductance in V_{IN} and/or V_{BIAS} inputs for example), the recommended $C_{IN} = 1\mu\text{F}$ and $C_{BIAS} = 0.1\mu\text{F}$ or greater. Ceramic capacitors are recommended. For the best performance all the capacitors should be connected to the SGM2037S respective pins directly in the device PCB copper layer, not through vias which have non-negligible impedance.

When using small ceramic capacitors, their capacitance is not constant but varies with applied DC biasing voltage, temperature and tolerance. The effective capacitance can be much lower than their nominal capacitance value and this is important in negative temperatures and higher LDO output voltages. That is the reason why the recommended output capacitor capacitance value is specified as effective value in the specific application conditions.

Enable Operation

The EN pin will turn the regulator ON or OFF. The threshold limits are covered in the Electrical Characteristics table in this datasheet.

Current Limit

The internal current limit circuitry allows the device to supply the full nominal current and surges but protects the device against current overload or short.

Thermal Protection

Internal thermal shutdown (TSD) circuitry is provided to protect the integrated circuit in the event that the maximum junction temperature is exceeded. When TSD is activated, the regulator output turns off. When cooling down below the low temperature threshold, device output is activated again. This TSD feature is provided to prevent failures from accidental overheating.

REVISION HISTORY

NOTE: Page numbers for previous revisions may differ from page numbers in the current version.

Changes from Original (MAY 2019) to REV.A

Changed from product preview to production data.....All

PACKAGE OUTLINE DIMENSIONS

UTDFN-1.2x1.2-6L

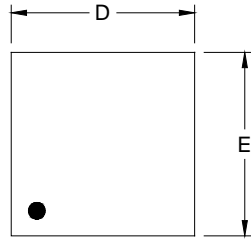

TOP VIEW

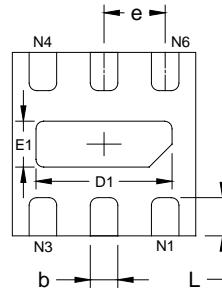

BOTTOM VIEW

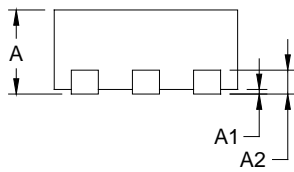

SIDE VIEW

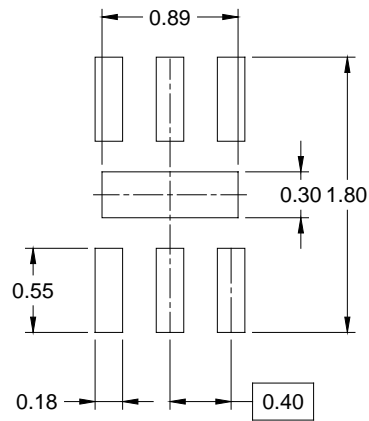

RECOMMENDED LAND PATTERN (Unit: mm)

Symbol	Dimensions In Millimeters		
	MIN	MOD	MAX
A	0.500	0.550	0.600
A1			0.050
A2	0.152 REF		
e	0.400 BSC		
D	1.150	1.200	1.250
E	1.150	1.200	1.250
D1	0.840	0.890	0.940
E1	0.250	0.300	0.350
b	0.130	0.180	0.230
L	0.200	0.250	0.300

PACKAGE INFORMATION

TAPE AND REEL INFORMATION

REEL DIMENSIONS



TAPE DIMENSIONS



NOTE: The picture is only for reference. Please make the object as the standard.

KEY PARAMETER LIST OF TAPE AND REEL

Package Type	Reel Diameter	Reel Width W1 (mm)	A0 (mm)	B0 (mm)	K0 (mm)	P0 (mm)	P1 (mm)	P2 (mm)	W (mm)	Pin1 Quadrant
UTDFN-1.2×1.2-6L	7"	9.0	1.35	1.35	0.73	4.0	4.0	2.0	8.0	Q1

000001

PACKAGE INFORMATION

CARTON BOX DIMENSIONS



NOTE: The picture is only for reference. Please make the object as the standard.

KEY PARAMETER LIST OF CARTON BOX

Reel Type	Length (mm)	Width (mm)	Height (mm)	Pizza/Carton
7" (Option)	368	227	224	8
7"	442	410	224	18

DD0002