

GENERAL DESCRIPTION

The SGM2211 is a low dropout linear regulator that operates from 2.7V to 20V and provides up to 500mA of output current. This high input voltage LDO provides wide output voltage range from 19V down to 1.2V rails that high performance analog and mixed signal circuits need. The SGM2211 provides high PSRR, low noise and excellent line and load transient responses with a small 2.2 μ F ceramic output capacitor. These features are very important for noise sensitive circuits.

The SGM2211 is available in fixed output voltage versions and an adjustable version that allows the output voltage to range from 1.2V to ($V_{IN} - V_{DROP}$) via an external feedback divider.

The SGM2211 regulator output noise is 9.3 μ V_{RMS} at 1.2V output voltage and 14 μ V_{RMS} at 5V output voltage.

The SGM2211 is available in Green TDFN-2 \times 2-6AL and SOT-23-5 packages. It operates over an operating temperature range of -40°C to +125°C.

APPLICATIONS

Power of Noise Sensitive Application: ADC and DAC Circuits, Precision Amplifiers, Power for VCO V_{TUNE} Control

Communications and Infrastructure

Medical and Healthcare

Industrial and Instrumentation

FEATURES

- **Input Voltage Range: 2.7V to 20V**
- **Low Noise:**
 - ◆ 9.3 μ V_{RMS} at $V_{OUT} = 1.2V$
 - ◆ 11 μ V_{RMS} at $V_{OUT} = 2.8V$
 - ◆ 14 μ V_{RMS} at $V_{OUT} = 5.0V$
- **PSRR ($V_{IN} = V_{OUT(NOM)} + 1V$):**
 - ◆ 100dB at 1kHz
 - ◆ 83dB at 10kHz
 - ◆ 52dB at 100kHz
 - ◆ 55dB at 1MHz
- **Maximum Output Current: 500mA**
- **Output Voltage Accuracy: $\pm 1\%$ at +25°C**
- **Low Dropout Voltage:**
360mV (TYP) at 500mA Load when $V_{OUT} = 5.0V$
- **User Programmable Soft-Start (TDFN Package Only)**
- **Low Quiescent Current: 39 μ A (TYP)**
- **Shutdown Current: 1.2 μ A (TYP)**
- **Stable with a 2.2 μ F Ceramic Output Capacitor**
- **Adjustable Output from 1.2V to ($V_{IN} - V_{DROP}$),
Output can be Adjusted above Initial Set Point**
- **Reverse Current Protection when $V_{OUT} > V_{IN}$**
- **Foldback Current-Limit Protection when V_{OUT} is Shorted to GND**
- **Automatic V_{OUT} Discharge when Disabled**
- **Precision Enable**
- **-40°C to +125°C Operating Temperature Range**
- **Available in Green TDFN-2 \times 2-6AL and SOT-23-5 Packages**

PACKAGE/ORDERING INFORMATION

MODEL	PACKAGE DESCRIPTION	SPECIFIED TEMPERATURE RANGE	ORDERING NUMBER	PACKAGE MARKING	PACKING OPTION
SGM2211-1.2	TDFN-2x2-6AL	-40°C to +125°C	SGM2211-1.2XTDI6G/TR	C1B XXXX	Tape and Reel, 3000
SGM2211-1.5	TDFN-2x2-6AL	-40°C to +125°C	SGM2211-1.5XTDI6G/TR	C1C XXXX	Tape and Reel, 3000
SGM2211-1.8	TDFN-2x2-6AL	-40°C to +125°C	SGM2211-1.8XTDI6G/TR	C1D XXXX	Tape and Reel, 3000
SGM2211-2.5	TDFN-2x2-6AL	-40°C to +125°C	SGM2211-2.5XTDI6G/TR	C1E XXXX	Tape and Reel, 3000
SGM2211-2.8	TDFN-2x2-6AL	-40°C to +125°C	SGM2211-2.8XTDI6G/TR	C1F XXXX	Tape and Reel, 3000
SGM2211-3.0	TDFN-2x2-6AL	-40°C to +125°C	SGM2211-3.0XTDI6G/TR	C20 XXXX	Tape and Reel, 3000
SGM2211-3.3	TDFN-2x2-6AL	-40°C to +125°C	SGM2211-3.3XTDI6G/TR	C21 XXXX	Tape and Reel, 3000
SGM2211-3.8	TDFN-2x2-6AL	-40°C to +125°C	SGM2211-3.8XTDI6G/TR	C22 XXXX	Tape and Reel, 3000
SGM2211-4.2	TDFN-2x2-6AL	-40°C to +125°C	SGM2211-4.2XTDI6G/TR	C23 XXXX	Tape and Reel, 3000
SGM2211-5.0	TDFN-2x2-6AL	-40°C to +125°C	SGM2211-5.0XTDI6G/TR	C24 XXXX	Tape and Reel, 3000
SGM2211-1.2	SOT-23-5	-40°C to +125°C	SGM2211-1.2XN5G/TR	C11XX	Tape and Reel, 3000
SGM2211-1.5	SOT-23-5	-40°C to +125°C	SGM2211-1.5XN5G/TR	C12XX	Tape and Reel, 3000
SGM2211-1.8	SOT-23-5	-40°C to +125°C	SGM2211-1.8XN5G/TR	C13XX	Tape and Reel, 3000
SGM2211-2.5	SOT-23-5	-40°C to +125°C	SGM2211-2.5XN5G/TR	C14XX	Tape and Reel, 3000
SGM2211-2.8	SOT-23-5	-40°C to +125°C	SGM2211-2.8XN5G/TR	C15XX	Tape and Reel, 3000
SGM2211-3.0	SOT-23-5	-40°C to +125°C	SGM2211-3.0XN5G/TR	C16XX	Tape and Reel, 3000
SGM2211-3.3	SOT-23-5	-40°C to +125°C	SGM2211-3.3XN5G/TR	C17XX	Tape and Reel, 3000
SGM2211-3.8	SOT-23-5	-40°C to +125°C	SGM2211-3.8XN5G/TR	C18XX	Tape and Reel, 3000
SGM2211-4.2	SOT-23-5	-40°C to +125°C	SGM2211-4.2XN5G/TR	C19XX	Tape and Reel, 3000
SGM2211-5.0	SOT-23-5	-40°C to +125°C	SGM2211-5.0XN5G/TR	C1AXX	Tape and Reel, 3000
SGM2211-ADJ	SOT-23-5	-40°C to +125°C	SGM2211-ADJXN5G/TR	C2FXX	Tape and Reel, 3000

MARKING INFORMATION

NOTE: XX = Date Code. XXXX = Date Code and Trace Code.

TDFN-2x2-6AL

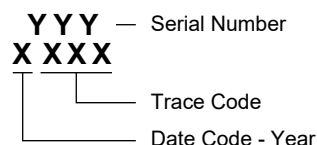

SOT-23-5

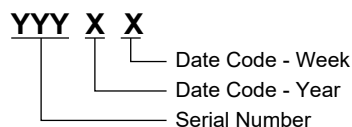

Green (RoHS & HSF): SG Micro Corp defines "Green" to mean Pb-Free (RoHS compatible) and free of halogen substances. If you have additional comments or questions, please contact your SGMICRO representative directly.

ABSOLUTE MAXIMUM RATINGS

VIN to GND.....	-0.3V to 24V
VOU to GND.....	-0.3V to 24V
EN to GND.....	-0.3V to 24V
SENSE/ADJ to GND.....	-0.3V to 24V
SS to GND.....	-0.3V to VIN or 6V (whichever is less)
Package Thermal Resistance	
TDFN-2x2-6AL, θ_{JA}	100°C/W
TDFN-2x2-6AL, θ_{JB}	37°C/W
TDFN-2x2-6AL, θ_{JC}	77°C/W
SOT-23-5, θ_{JA}	182°C/W
SOT-23-5, θ_{JB}	44°C/W
SOT-23-5, θ_{JC}	70°C/W
Junction Temperature.....	+150°C
Storage Temperature Range.....	-65°C to +150°C
Lead Temperature (Soldering, 10s).....	+260°C
ESD Susceptibility	
HBM.....	8000V
CDM.....	1000V

RECOMMENDED OPERATING CONDITIONS

Input Voltage Range.....	2.7V to 20V
Operating Junction Temperature Range.....	-40°C to +125°C
Input Capacitance, CIN.....	1.5µF (MIN)
Output Capacitance, COUT.....	1.5µF to 10µF

OVERSTRESS CAUTION

Stresses beyond those listed in Absolute Maximum Ratings may cause permanent damage to the device. Exposure to absolute maximum rating conditions for extended periods may affect reliability. Functional operation of the device at any conditions beyond those indicated in the Recommended Operating Conditions section is not implied.

ESD SENSITIVITY CAUTION

This integrated circuit can be damaged by ESD if you don't pay attention to ESD protection. SGMICRO recommends that all integrated circuits be handled with appropriate precautions. Failure to observe proper handling and installation procedures can cause damage. ESD damage can range from subtle performance degradation to complete device failure. Precision integrated circuits may be more susceptible to damage because very small parametric changes could cause the device not to meet its published specifications.

DISCLAIMER

SG Micro Corp reserves the right to make any change in circuit design, or specifications without prior notice.

PIN CONFIGURATIONS

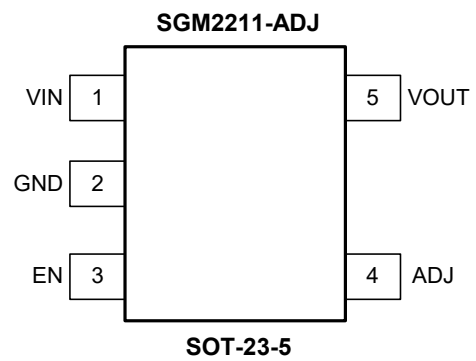
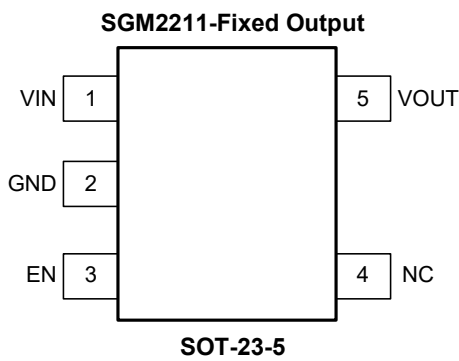
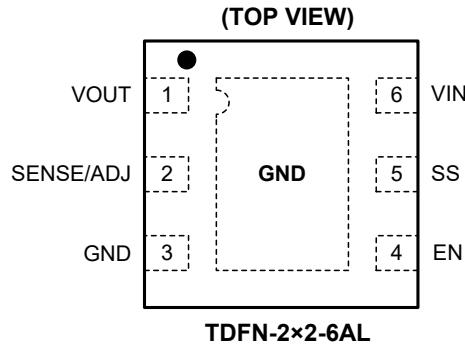

PIN DESCRIPTION

PIN		NAME	FUNCTION
TDFN-2x2-6AL	SOT-23-5		
1	5	VOUT	Regulated Output Voltage. It is recommended to use output capacitor with effective capacitance in the range of 1.5μF to 10μF. The capacitor should be located very close to this pin.
2	–	SENSE/ADJ	Sense Input (SENSE). Connect to load. An external resistor divider may also set the output voltage higher than the fixed output voltage (ADJ).
3	2	GND	Ground.
4	3	EN	Enable Pin. Driving EN high to turn on the regulator. Driving EN low to turn off the regulator. For automatic startup, connect EN pin to VIN pin.
5	–	SS	Soft-Start. An external capacitor connected to this pin determines the soft-start time. Leave this pin open for a typical 150μs start-up time. Do not ground this pin.
6	1	VIN	Regulator Input Supply. Additional bypass capacitance may be required to provide a stable input voltage. Bypass VIN pin to GND with a 2.2μF or larger capacitor. The capacitor should be located very close to this pin.
–	4	NC	Not Connected (fixed voltage version only).
–		ADJ	Adjustable Input (adjustable voltage version only). This is used to set the output voltage of the device. The typical ADJ pin voltage is 1.2V.
Exposed Pad	–	GND	Exposed Pad. The exposed pad on the bottom of the package enhances thermal performance and is electrically connected to GND inside the package. It is recommended that the exposed pad connect to the ground plane on the board.

ELECTRICAL CHARACTERISTICS

($V_{IN} = (V_{OUT(NOM)} + 1V)$ or 2.7V, whichever is greater, $V_{EN} = V_{IN}$, $I_{OUT} = 10mA$, $C_{IN} = C_{OUT} = 2.2\mu F$ and $C_{SS} = 0nF$, $T_J = -40^\circ C$ to $+125^\circ C$, typical values are at $T_J = +25^\circ C$, unless otherwise noted.)

PARAMETER	SYMBOL	CONDITIONS	TEMP	MIN	TYP	MAX	UNITS	
Input Voltage Range	V_{IN}		-40°C to +125°C	2.7		20	V	
Under-Voltage Lockout Thresholds	V_{UVLO}	V_{IN} rising	-40°C to +125°C		2.52	2.70	V	
		V_{IN} falling	-40°C to +125°C	2.16	2.33			
Operating Supply Current	I_{GND}	$I_{OUT} = 0\mu A$	-40°C to +125°C		39	62	μA	
		$I_{OUT} = 500mA$	-40°C to +125°C		980	1200		
Shutdown Current	I_{SHDN}	$V_{EN} = GND$	-40°C to +125°C		1.2	2.2	μA	
		$V_{EN} = GND$, $V_{IN} = 20V$	-40°C to +125°C		1.3	2.5		
ADJ Input Bias Current	I_{ADJ}	$V_{ADJ} = V_{OUT(NOM)} + 0.1V$	-40°C to +125°C	-6		6	nA	
Output Voltage Accuracy	V_{OUT}	$V_{IN} = (V_{OUT(NOM)} + 1V)$ to 20V, $I_{OUT} = 100\mu A$ to 500mA	+25°C	-1		1	%	
			-40°C to +125°C	-1.6		1.6		
Feedback Voltage	V_{ADJ}	$I_{OUT} = 10mA$	+25°C	1.188	1.2	1.212	V	
		$V_{IN} = (V_{OUT(NOM)} + 1V)$ to 20V, $I_{OUT} = 100\mu A$ to 500mA	-40°C to +125°C	1.181		1.219		
Input Reverse Current	$I_{REV-INPUT}$	$V_{EN} = GND$, $V_{IN} = 0V$, $V_{OUT} = 20V$	-40°C to +125°C		0.05	1	μA	
Line Regulation	$\frac{\Delta V_{OUT}}{\Delta V_{IN} \times V_{OUT}}$	$V_{IN} = (V_{OUT(NOM)} + 1V)$ to 20V	-40°C to +125°C		0.001	0.007	%/V	
Load Regulation	ΔV_{OUT}	$I_{OUT} = 100\mu A$ to 500mA	-40°C to +125°C		3	26	mV	
Dropout Voltage ⁽¹⁾	V_{DROP}	$I_{OUT} = 500mA$	$V_{OUT(NOM)} = 2.5V$	-40°C to +125°C		500	730	mV
			$V_{OUT(NOM)} = 3.0V$	-40°C to +125°C		450	680	
			$V_{OUT(NOM)} = 5.0V$	-40°C to +125°C		360	580	
Soft-Start Source Current	$SS_{I-SOURCE}$	$SS = GND$	-40°C to +125°C		1	3	μA	
Output Current Limit	I_{LIMIT}	$V_{OUT} = V_{OUT(NOM)} - 1V$ ⁽²⁾	+25°C	0.51	0.80		A	
Output Voltage Noise	e_n	f = 10Hz to 100kHz, $I_{OUT} = 1mA$	$V_{OUT} = 1.2V$	+25°C		9.3	μV_{RMS}	
			$V_{OUT} = 2.8V$	+25°C		11		
			$V_{OUT} = 5.0V$	+25°C		14		
Power Supply Rejection Ratio	PSRR	$V_{IN} = V_{OUT(NOM)} + 1V$	f = 1kHz	+25°C		100	dB	
			f = 10kHz	+25°C		83		
			f = 100kHz	+25°C		52		
			f = 1MHz	+25°C		55		
Precision EN Input	V_{IH}	Logic high, $V_{IN} = 2.7V$ to 20V	-40°C to +125°C	1.120	1.210	1.295	V	
	V_{IL}	Logic low, $V_{IN} = 2.7V$ to 20V	-40°C to +125°C	1.050	1.120	1.195		
Leakage Current	I_{EN-LKG}	$V_{EN} = V_{IN}$, $V_{IN} = 2.7V$ to 20V	-40°C to +125°C		0.1	1	μA	
Start-Up Time	t_{STR}	From EN rising from 0V to V_{IN} to $0.9 \times V_{OUT}$, $V_{OUT} = 1.2V$	+25°C		150		μs	
Discharge Resistor	R_{DIS}	$V_{EN} = 0V$, $V_{OUT} = 0.5V$	-40°C to +125°C		100	140	Ω	
Thermal Shutdown Temperature	T_{SHDN}				160		°C	
Thermal Shutdown Hysteresis	ΔT_{SHDN}				20		°C	

NOTES:

- Dropout voltage is characterized when V_{OUT} falls 5% below $V_{OUT(NOM)}$.
- $V_{OUT} = V_{OUT(NOM)} - 0.2V$ when $V_{OUT} = 1.2V$.

TYPICAL PERFORMANCE CHARACTERISTICS

$V_{IN} = (V_{OUT(NOM)} + 1V)$ or 2.7V, whichever is greater, $V_{EN} = V_{IN}$, $I_{OUT} = 10mA$, $C_{IN} = C_{OUT} = 2.2\mu F$, $T_J = +25^\circ C$, unless otherwise noted.

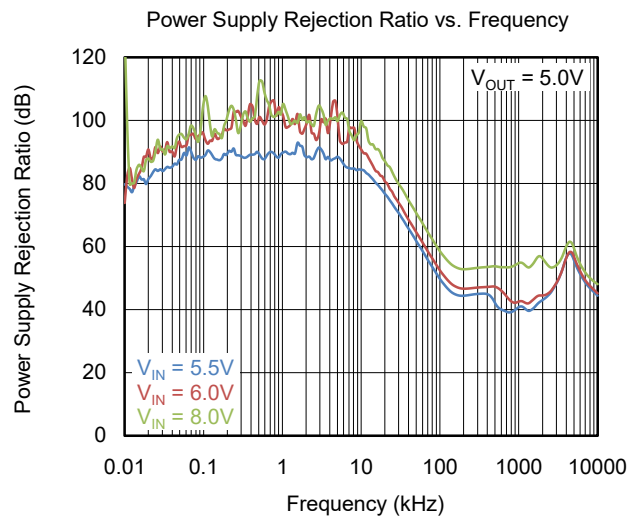
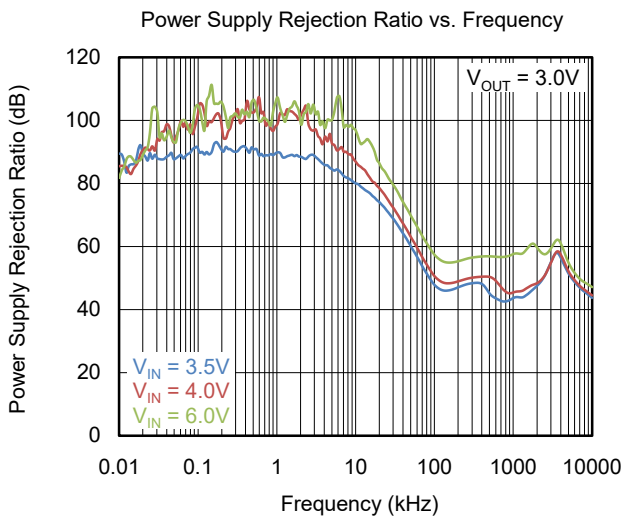
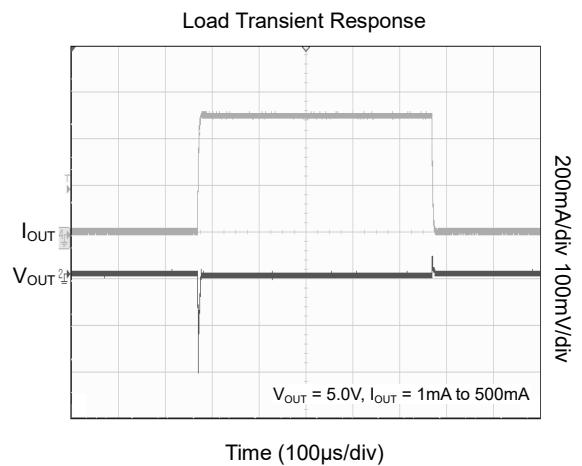
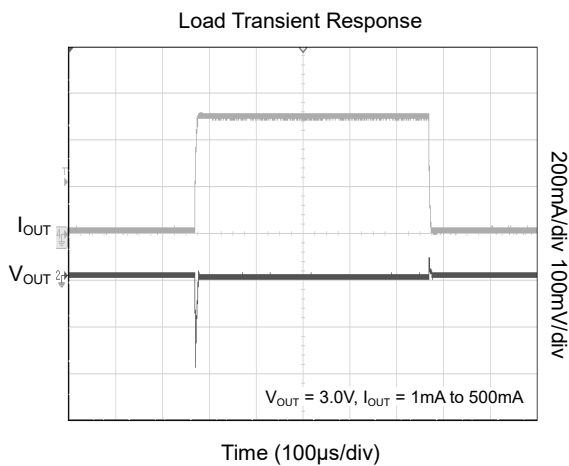
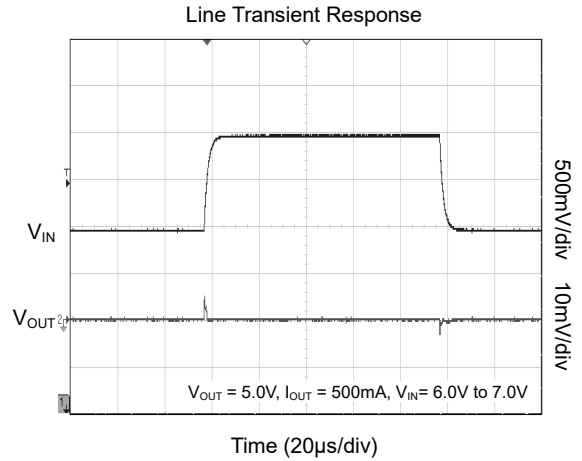
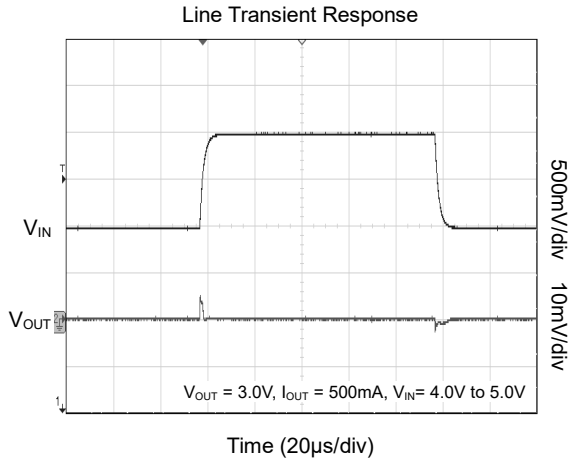

TYPICAL PERFORMANCE CHARACTERISTICS (continued)

$V_{IN} = (V_{OUT(NOM)} + 1V)$ or 2.7V, whichever is greater, $V_{EN} = V_{IN}$, $I_{OUT} = 10mA$, $C_{IN} = C_{OUT} = 2.2\mu F$, $T_J = +25^\circ C$, unless otherwise noted.

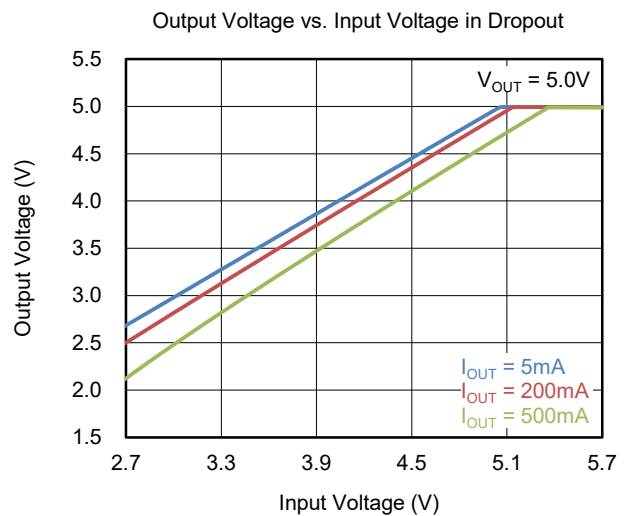
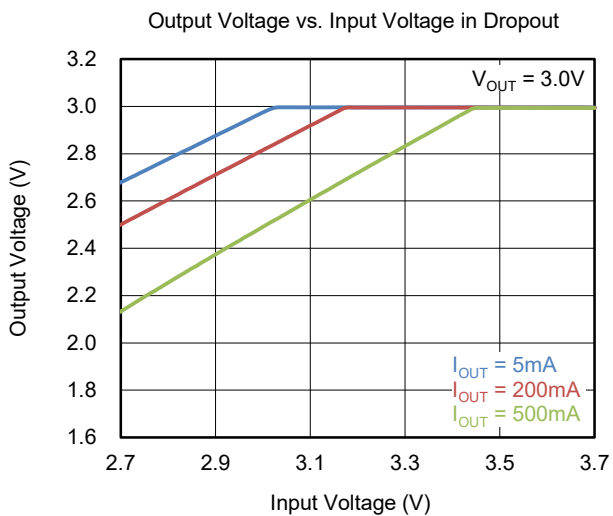
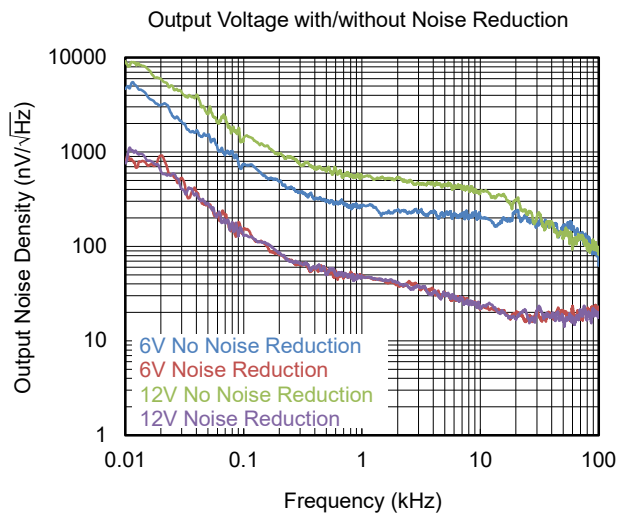
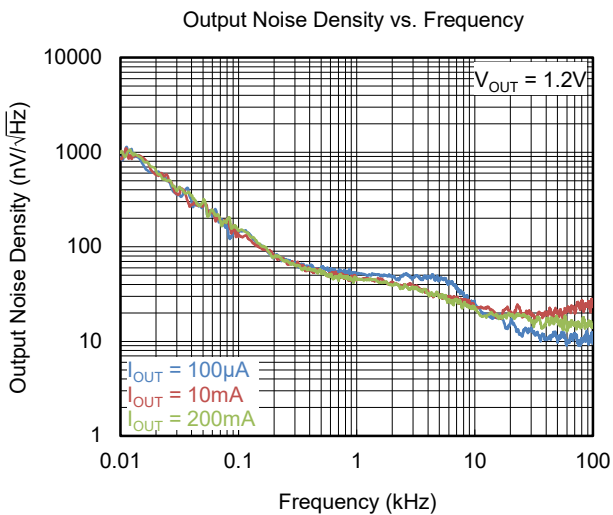
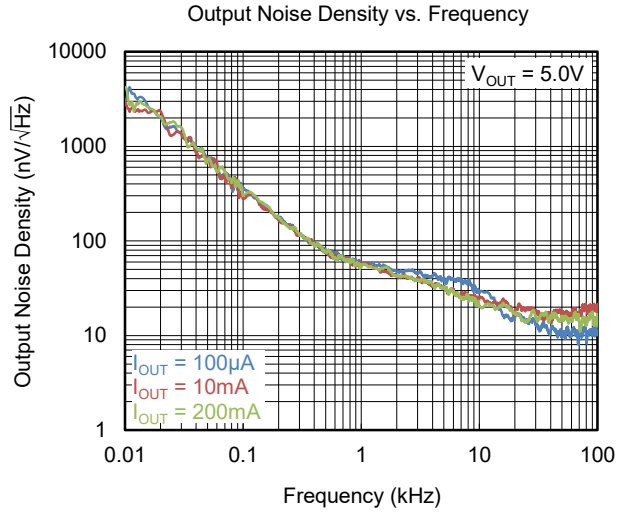
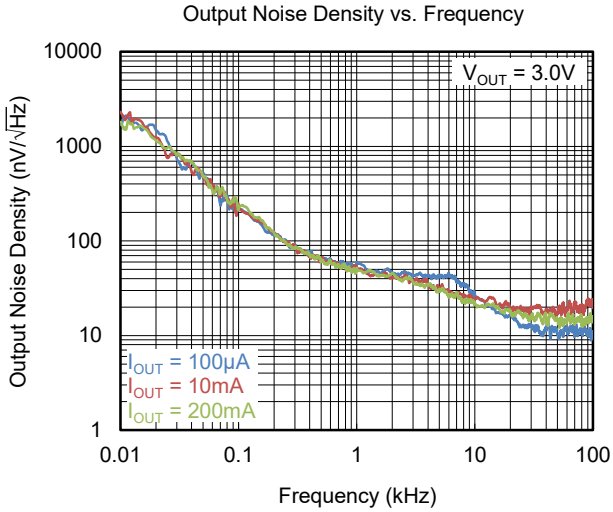

TYPICAL PERFORMANCE CHARACTERISTICS (continued)

$V_{IN} = (V_{OUT(NOM)} + 1V)$ or 2.7V, whichever is greater, $V_{EN} = V_{IN}$, $I_{OUT} = 10mA$, $C_{IN} = C_{OUT} = 2.2\mu F$, $T_J = +25^\circ C$, unless otherwise noted.

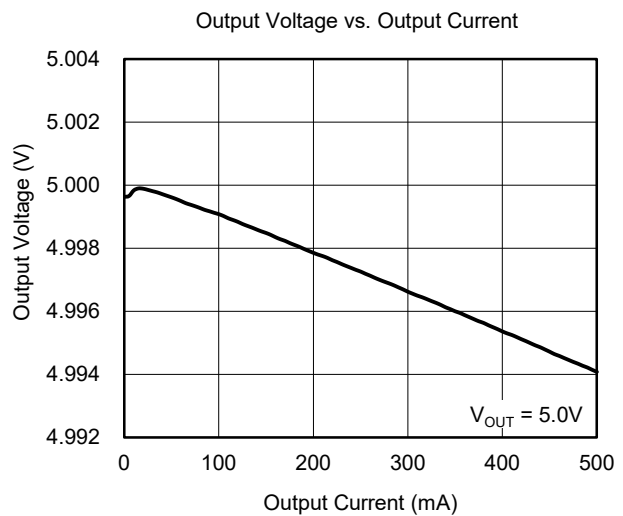
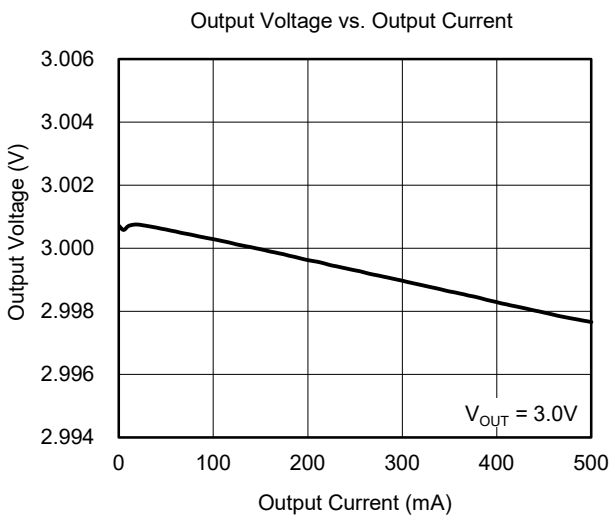
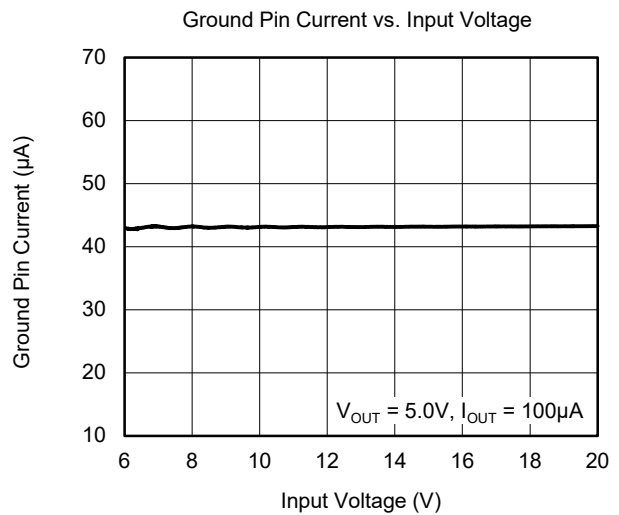
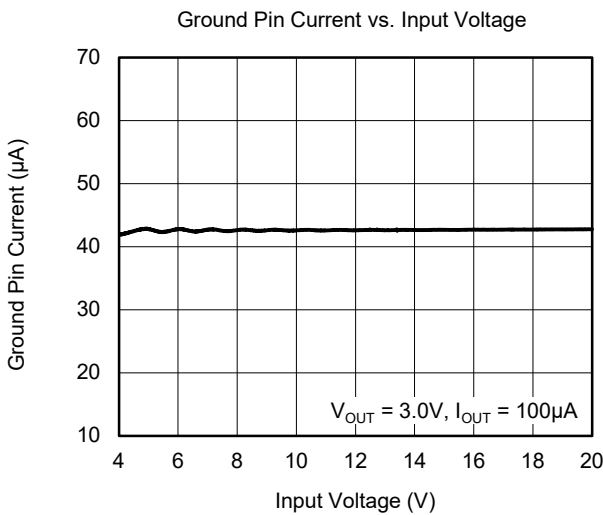
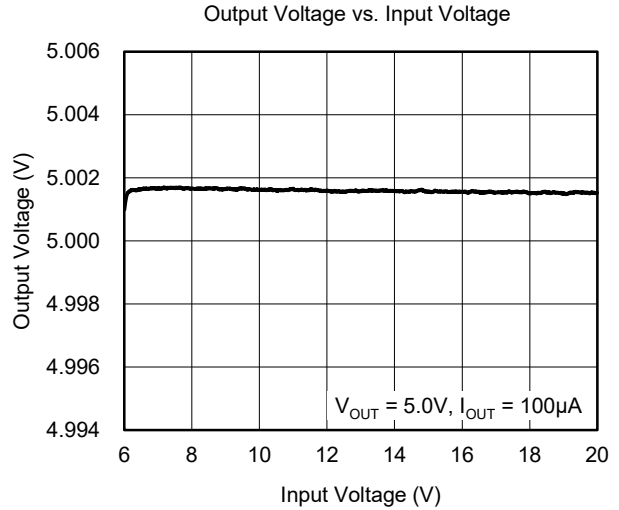
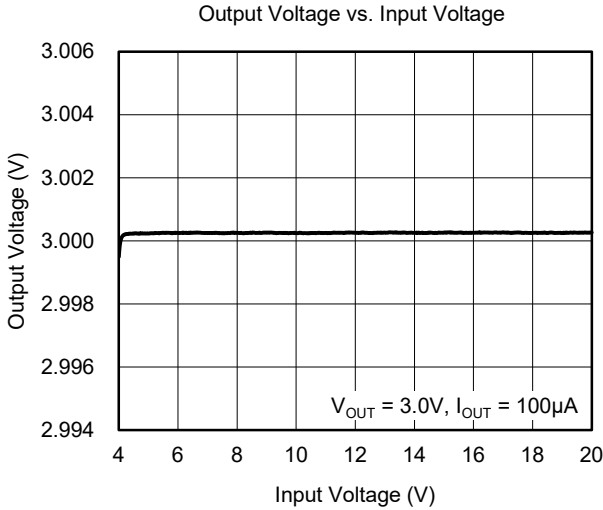

TYPICAL PERFORMANCE CHARACTERISTICS (continued)

$V_{IN} = (V_{OUT(NOM)} + 1V)$ or 2.7V, whichever is greater, $V_{EN} = V_{IN}$, $I_{OUT} = 10mA$, $C_{IN} = C_{OUT} = 2.2\mu F$, $T_J = +25^\circ C$, unless otherwise noted.

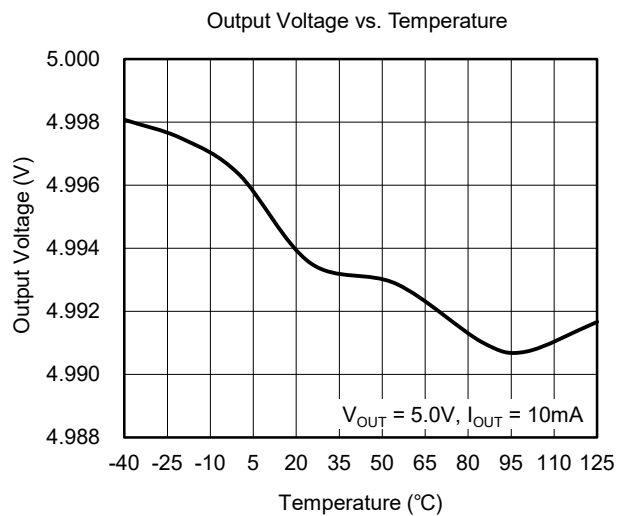
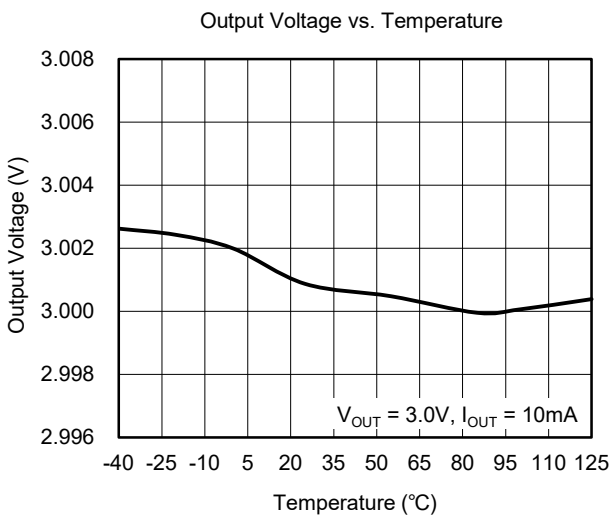
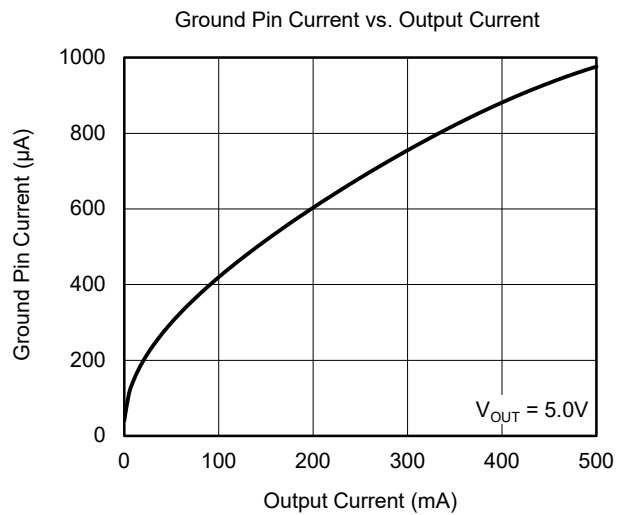
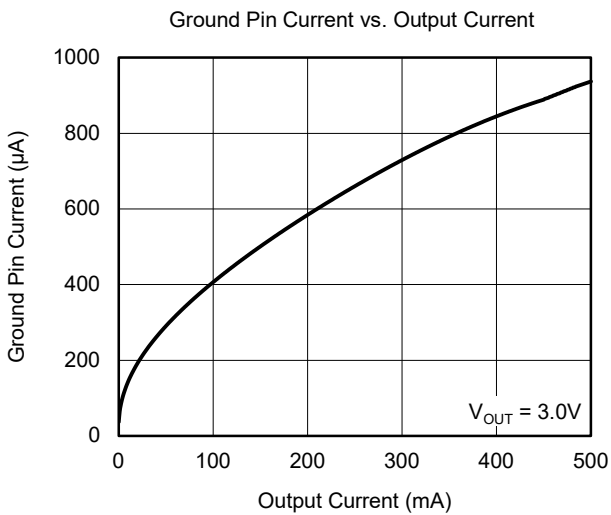
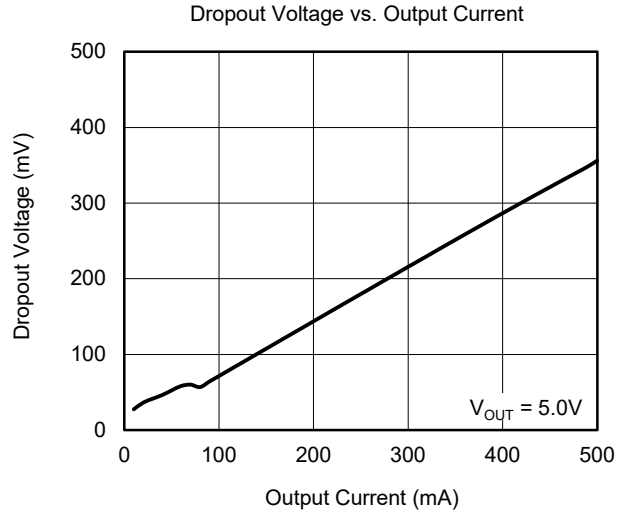
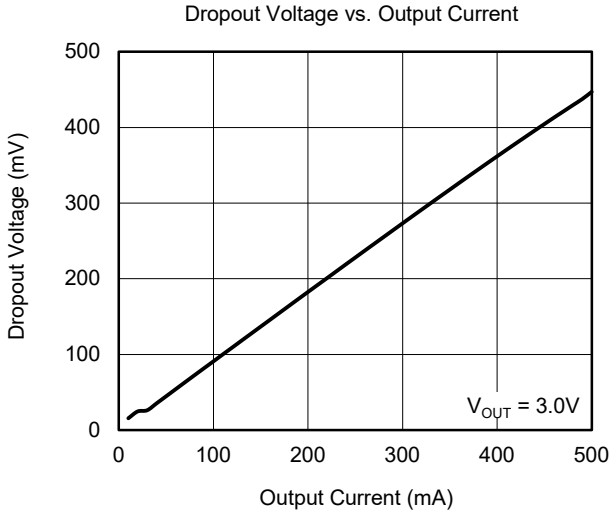

TYPICAL PERFORMANCE CHARACTERISTICS (continued)

$V_{IN} = (V_{OUT(NOM)} + 1V)$ or $2.7V$, whichever is greater, $V_{EN} = V_{IN}$, $I_{OUT} = 10mA$, $C_{IN} = C_{OUT} = 2.2\mu F$, $T_J = +25^\circ C$, unless otherwise noted.

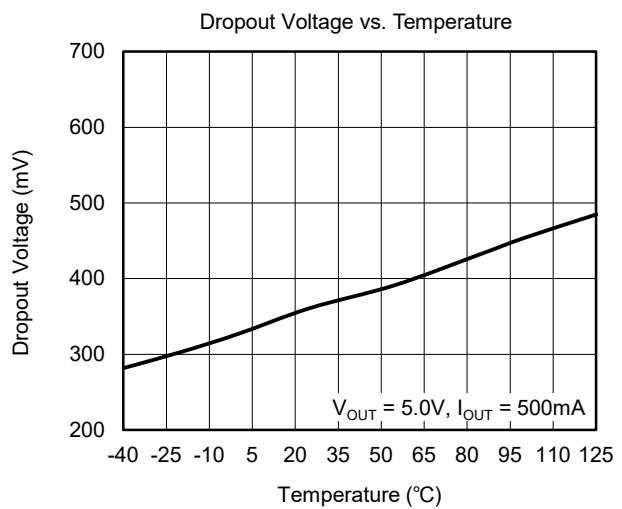
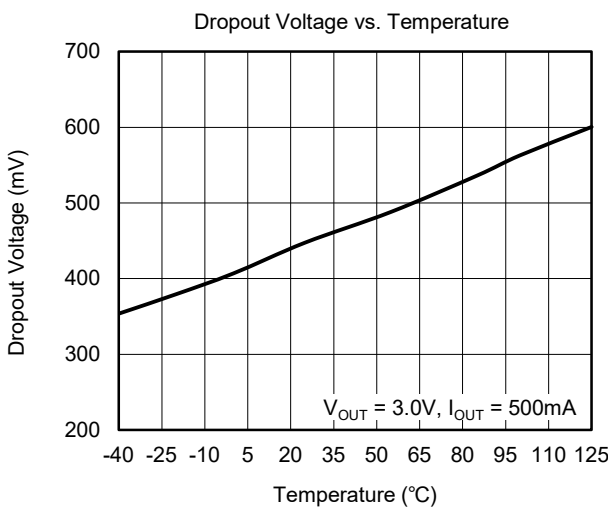
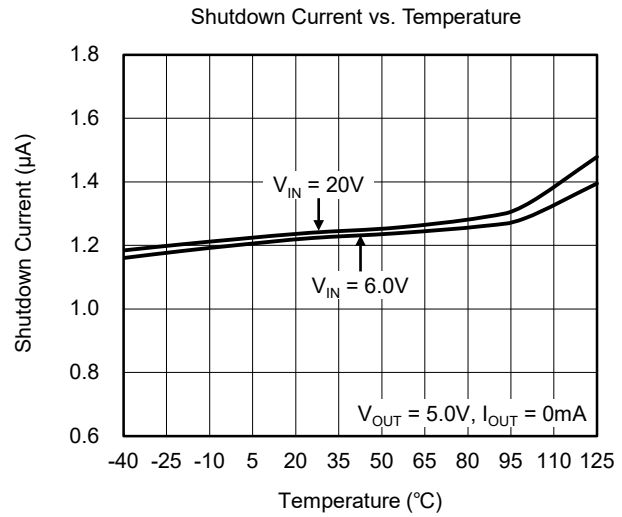
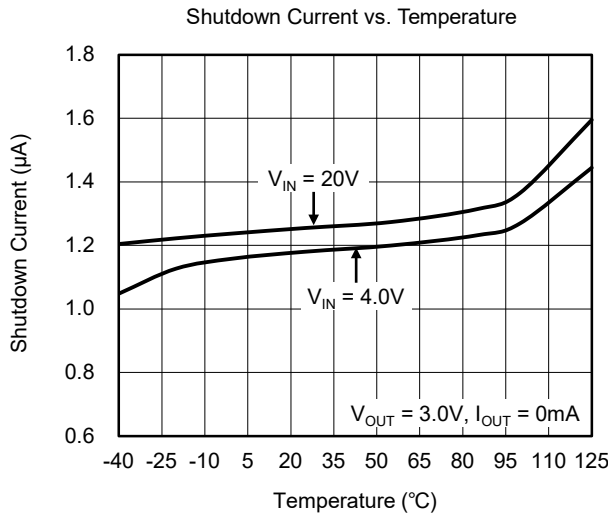
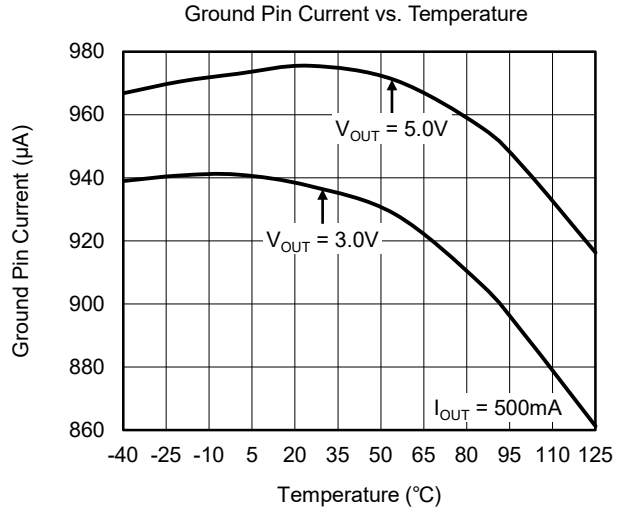
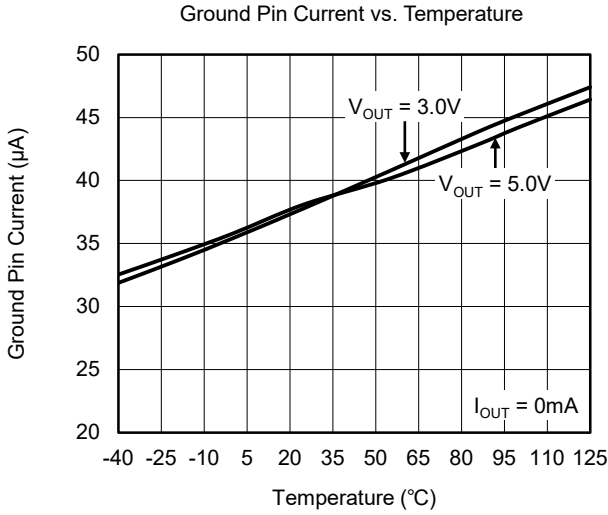

TYPICAL PERFORMANCE CHARACTERISTICS (continued)

$V_{IN} = (V_{OUT(NOM)} + 1V)$ or 2.7V, whichever is greater, $V_{EN} = V_{IN}$, $I_{OUT} = 10mA$, $C_{IN} = C_{OUT} = 2.2\mu F$, $T_J = +25^{\circ}C$, unless otherwise noted.

Typical Start-Up Behavior

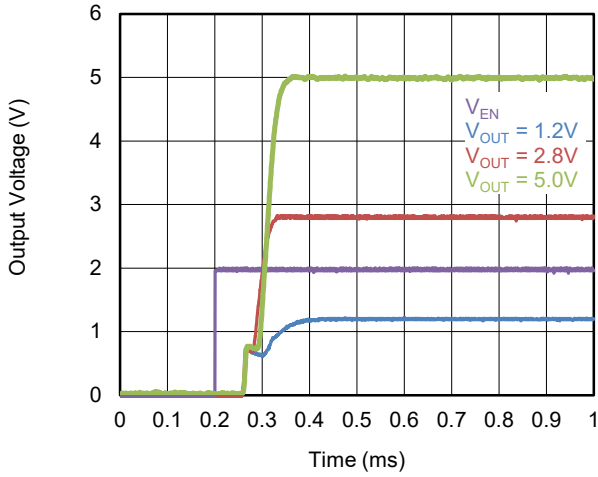

Typical Soft-Start Behavior, Different C_{SS}

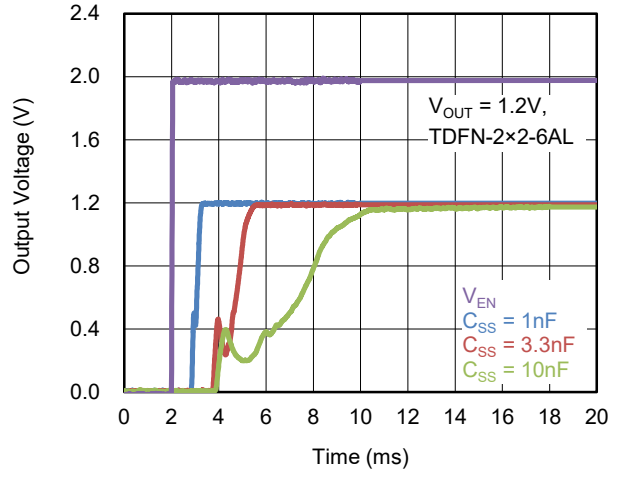

Typical Soft-Start Behavior, Different C_{SS}

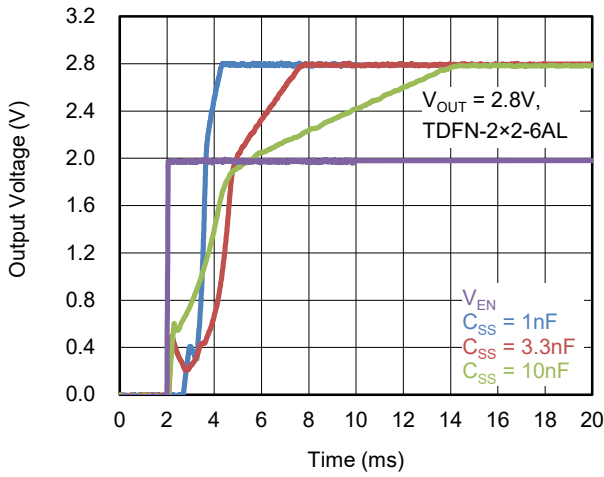

Typical Soft-Start Behavior, Different C_{SS}

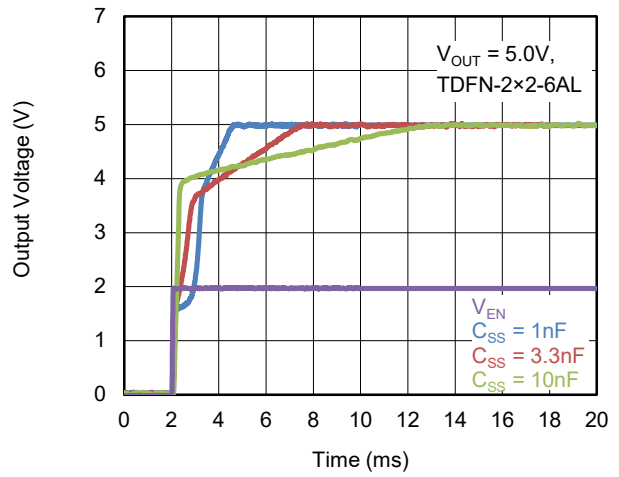

TYPICAL APPLICATION CIRCUITS

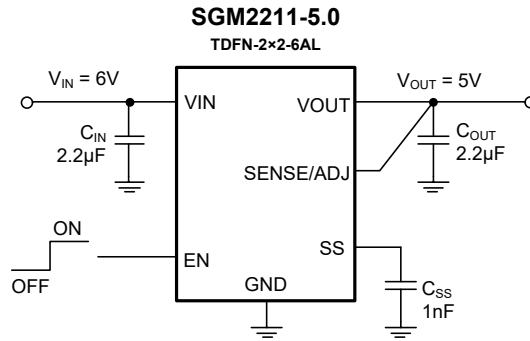

Figure 1. SGM2211 with Fixed Sense Output Voltage, 5V

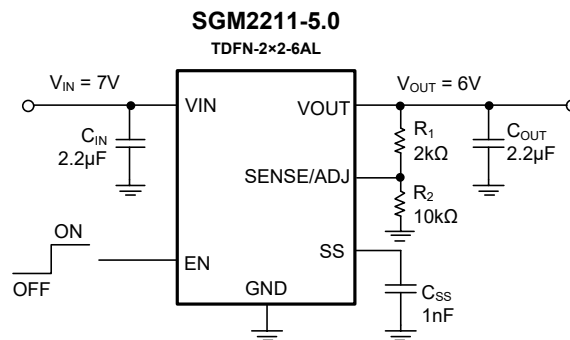

Figure 2. SGM2211 with 5V Output Adjusted to 6V

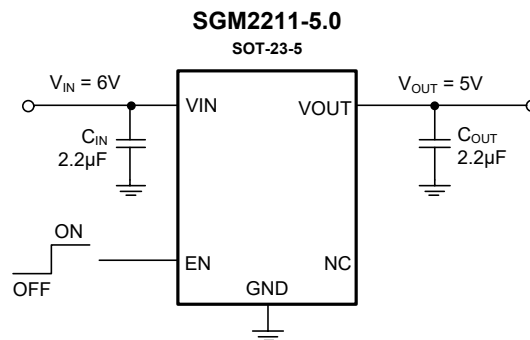

Figure 3. SGM2211 with Fixed Output Voltage, 5V

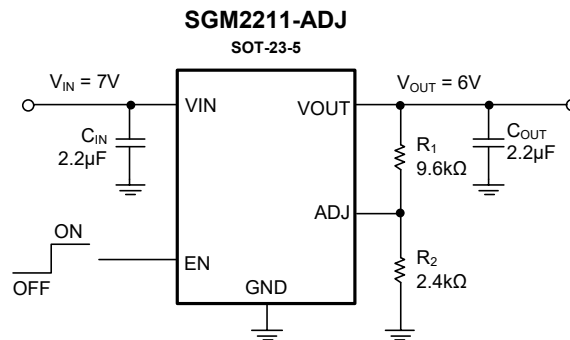

Figure 4. SGM2211 with 1.2V Output Adjusted to 6V

FUNCTIONAL BLOCK DIAGRAM

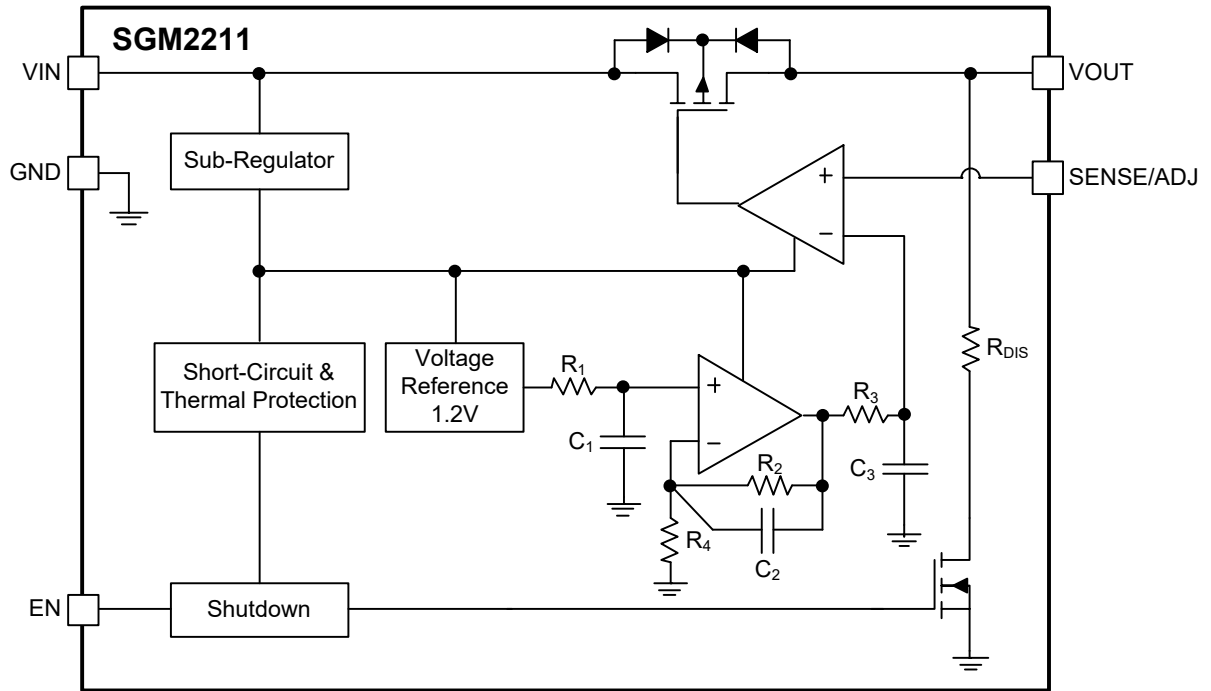

Figure 5. Block Diagram (TDFN-2x2-6AL and SOT-23-5 Adjustable Version)

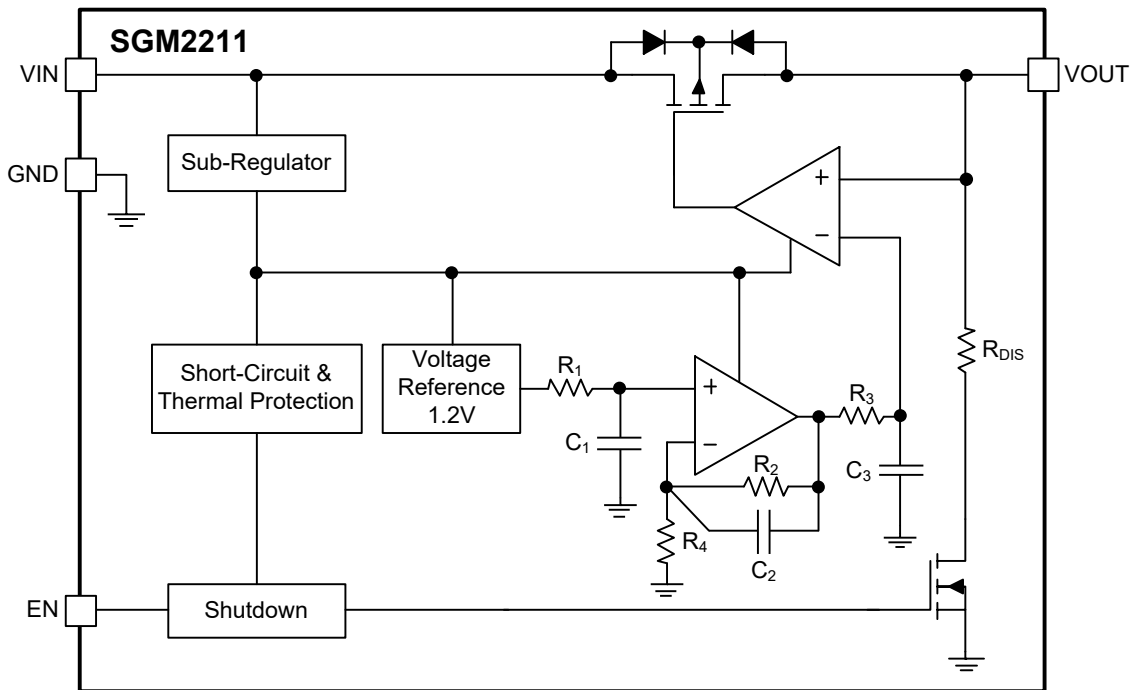

Figure 6. Block Diagram (SOT-23-5 Fixed Version)

DETAILED DESCRIPTION

The SGM2211 is a low noise, low quiescent current and low dropout voltage linear regulator that operates from 2.7V to 20V and can provide up to 500mA of output current. Typical shutdown current consumption is 1.2µA.

The SGM2211 is optimized to use small 2.2µF ceramic capacitors (C_{IN} and C_{OUT}) to achieve excellent transient performance.

The SGM2211 is available in fixed output voltage options, ranging from 1.2V to 5.0V. The SGM2211 architecture allows any fixed output voltage to be set to a higher voltage with an external voltage divider. For example, a fixed 5V output can be set to a 6V output according to the following equation:

$$V_{OUT} = 5V \times (1 + R_1/R_2)$$

where R₁ and R₂ are the resistors in the output voltage divider shown in Figure 7. It is recommended that the R₂ value be less than 200kΩ to minimize errors in the output voltage caused by the input current of SENSE/ADJ pin.

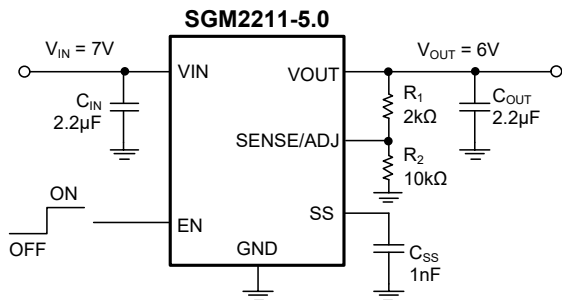

Figure 7. Typical 5V Adjustable Output Voltage Application Schematic

To set the output voltage of the adjustable SGM2211, replace 5V in the equation with 1.2V:

$$V_{OUT} = 1.2V \times (1 + R_1/R_2)$$

For example, when R₁ and R₂ each equal 200kΩ and the default output voltage is 1.2V as shown in Figure 8, the adjusted output voltage is 2.4V.

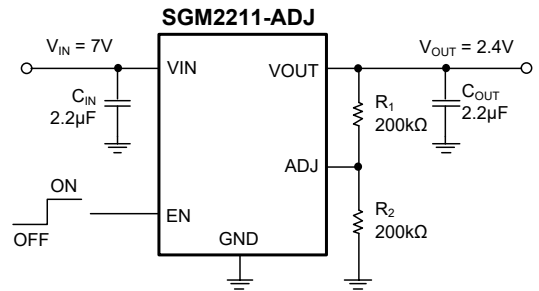

Figure 8. SGM2211 with 1.2V Output Adjusted to 2.4V

APPLICATION INFORMATION

Output Capacitor Selection

The SGM2211 is designed to work with small size ceramic capacitors; however, other types of capacitor also can be used. The ESR of capacitor is the most important parameter to be taken into account, and the ESR of the output capacitor affects the stability of the LDO. A minimum of 2.2µF capacitance with an ESR of 0.2Ω or less is recommended to ensure the stability of the SGM2211. If good load transient is important in application, larger output capacitor can be used.

Input Bypass Capacitor Selection

In applications, if high source impedance or long input traces are encountered, a 2.2µF capacitor is connected from VIN pin to GND pin to reduce the circuit sensitivity to PCB layout. A larger input capacitor will be selected if the output capacitor is increased.

Input and Output Capacitor Properties

Ceramic capacitors are manufactured with a variety of dielectrics and each type of dielectrics has different behavior over temperature and applied voltage. Capacitors must have an adequate dielectric constant to ensure the minimum capacitance over the necessary temperature range and DC bias conditions.

Programmable Precision Enable

The EN pin is used to enable and disable the VOUT pin under normal operating conditions. When a rising voltage on EN is at 1.2V, VOUT turns on and when a falling voltage on EN is at 1.1V, VOUT turns off. For automatic startup, EN pin be connected to VIN pin. The hysteresis of the EN threshold is approximately 100mV. The enable voltage can be positive or negative with respect to ground.

The upper and lower thresholds are user programmable and can be set higher than the nominal 1.2V threshold by using two resistors. The resistance values, R_{EN1} and R_{EN2}, can be determined from the following:

$$R_{EN2} = \text{nominally } 10k\Omega \text{ to } 100k\Omega$$

$$R_{EN1} = R_{EN2} \times (V_{IN} - 1.2V)/1.2V$$

where V_{IN} is the desired turn-on voltage.

The hysteresis voltage increases by the factor (R_{EN1} + R_{EN2})/R_{EN2}. For the example shown in Figure 9, the enable threshold is 3.6V with a hysteresis of 300mV.

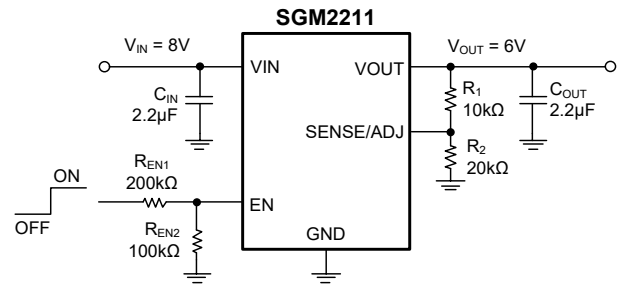

Figure 9. Typical EN Pin Voltage Divider

Soft-Start

The SGM2211 uses an internal soft-start (SS pin open) to limit the inrush current when the device is enabled. The start-up time for the 1.2V option is approximately 150µs from the time the EN active threshold is crossed to when the output reaches 90% of the final value.

Noise Reduction of the Adjustable SGM2211

The disadvantage of the conventional LDO architecture is that the output voltage noise is proportional to the output voltage. The output noise of adjustable LDO circuit can be modified slightly to levels close to that of the fixed output LDO. The circuit shown in Figure 10 adds two additional components to the output voltage setting resistor divider. C_{NR} and R_{NR} are added in parallel with R₁ to reduce the AC gain of the error amplifier. R_{NR} is chosen to be small with respect to R₂. If R_{NR} is 1% to 10% of the value of R₂, the minimum AC gain of the error amplifier is approximately 0.1dB to 0.8dB. The actual gain is determined by the parallel combination of R_{NR} and R₁. This gain ensures that the error amplifier always operates at slightly greater than unity gain.

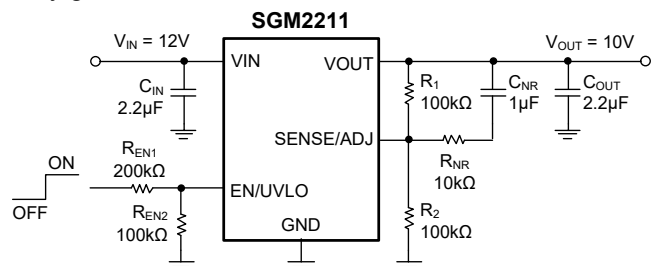

Figure 10. Noise Reduction Modification

C_{NR} is chosen by setting the reactance of C_{NR} equal to R₁ - R_{NR} at a frequency between 1Hz and 50Hz. This setting places the frequency where the AC gain of the error amplifier is 3dB down from the DC gain.

APPLICATION INFORMATION (continued)

Current-Limit and Thermal Overload Protection

The SGM2211 is protected against damage due to excessive power dissipation by current-limit and thermal overload protection circuits. The SGM2211 is designed to current limit when the output load reaches 0.8A (TYP). When the output load exceeds 0.8A, the output voltage is reduced to maintain a constant current limit.

Under the extreme conditions of high ambient temperature or power dissipation, when the junction temperature is above +160°C, the output is turned off, reducing the output current to 0mA. When the junction

temperature falls below +140°C, the output is turned on again and the output current is restored to the nominal value.

For reliable operation, device power dissipation must be externally limited so that the junction temperature do not exceed +125°C.

PCB Layout Considerations

Place the input capacitor as close as possible to the VIN and GND pins. Place the output capacitor as close as possible to the VOUT and GND pins.

REVISION HISTORY

NOTE: Page numbers for previous revisions may differ from page numbers in the current version.

Changes from Original (DECEMBER 2019) to REV.A	Page
Changed from product preview to production data.....	All

PACKAGE OUTLINE DIMENSIONS

TDFN-2x2-6AL

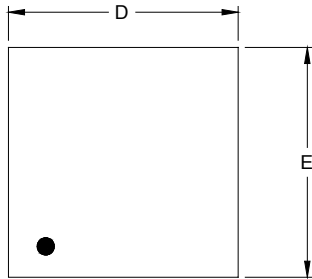

TOP VIEW

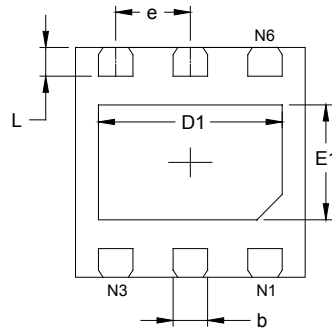

BOTTOM VIEW

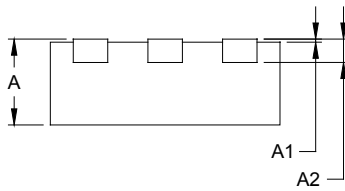

SIDE VIEW

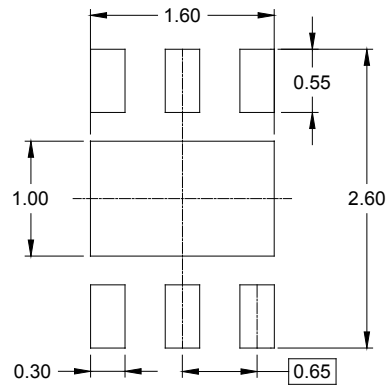

RECOMMENDED LAND PATTERN (Unit: mm)

Symbol	Dimensions In Millimeters		Dimensions In Inches	
	MIN	MAX	MIN	MAX
A	0.700	0.800	0.028	0.031
A1	0.000	0.050	0.000	0.002
A2	0.203 REF		0.008 REF	
D	1.900	2.100	0.075	0.083
D1	1.500	1.700	0.059	0.067
E	1.900	2.100	0.075	0.083
E1	0.900	1.100	0.035	0.043
b	0.250	0.350	0.010	0.014
e	0.650 BSC		0.026 BSC	
L	0.174	0.326	0.007	0.013

PACKAGE OUTLINE DIMENSIONS

SOT-23-5

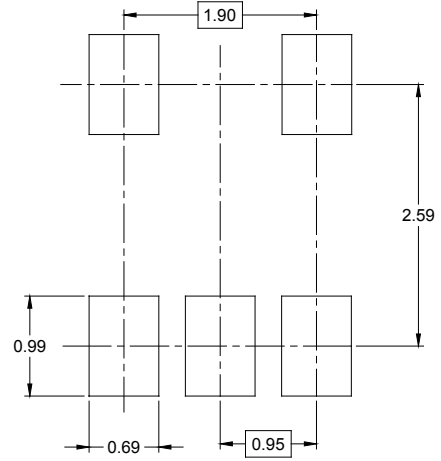

RECOMMENDED LAND PATTERN (Unit: mm)



Symbol	Dimensions In Millimeters		Dimensions In Inches	
	MIN	MAX	MIN	MAX
A	1.050	1.250	0.041	0.049
A1	0.000	0.100	0.000	0.004
A2	1.050	1.150	0.041	0.045
b	0.300	0.500	0.012	0.020
c	0.100	0.200	0.004	0.008
D	2.820	3.020	0.111	0.119
E	1.500	1.700	0.059	0.067
E1	2.650	2.950	0.104	0.116
e	0.950 BSC		0.037 BSC	
e1	1.900 BSC		0.075 BSC	
L	0.300	0.600	0.012	0.024
θ	0°	8°	0°	8°

TAPE AND REEL INFORMATION

REEL DIMENSIONS



TAPE DIMENSIONS



NOTE: The picture is only for reference. Please make the object as the standard.

KEY PARAMETER LIST OF TAPE AND REEL

Package Type	Reel Diameter	Reel Width W1 (mm)	A0 (mm)	B0 (mm)	K0 (mm)	P0 (mm)	P1 (mm)	P2 (mm)	W (mm)	Pin1 Quadrant
TDFN-2×2-6AL	7"	9.5	2.30	2.30	1.10	4.0	4.0	2.0	8.0	Q1
SOT-23-5	7"	9.5	3.20	3.20	1.40	4.0	4.0	2.0	8.0	Q3

DD0001

PACKAGE INFORMATION

CARTON BOX DIMENSIONS



NOTE: The picture is only for reference. Please make the object as the standard.

KEY PARAMETER LIST OF CARTON BOX

Reel Type	Length (mm)	Width (mm)	Height (mm)	Pizza/Carton
7" (Option)	368	227	224	8
7"	442	410	224	18

DD0002