

TPS22925 3.6-V, 3-A, 9-mΩ On-Resistance Load Switch

1 Features

- Input Voltage Range: 0.65 V to 3.6 V
- On-Resistance
 - $R_{ON} = 9.2 \text{ m}\Omega$ at $V_{IN} = 3.6 \text{ V}$
 - $R_{ON} = 9.2 \text{ m}\Omega$ at $V_{IN} = 1.8 \text{ V}$
 - $R_{ON} = 10.2 \text{ m}\Omega$ at $V_{IN} = 1 \text{ V}$
 - $R_{ON} = 13.1 \text{ m}\Omega$ at $V_{IN} = 0.65 \text{ V}$
- 3-A Maximum Continuous Switch Current
- Quiescent Current, $I_{Q,VIN} = 29 \mu\text{A}$ at $V_{IN} = 3.6 \text{ V}$
- Low Control Input Threshold Enables 1.5-, 1.8-, 2.5-, or 3.3-V Logic
- Controlled Slew Rate
 - $t_R = 97 \mu\text{s}$ at $V_{IN} = 3.6 \text{ V}$ (TPS22925Bx)
 - $t_R = 810 \mu\text{s}$ at $V_{IN} = 3.6 \text{ V}$ (TPS22925Cx)
- Reverse Current Blocking (When Disabled)
- Quick Output Discharge (QOD) (TPS22925B and TPS22925C only)
- Wafer Chip Scale Package:
 - 0.9 mm x 1.4 mm, 0.5-mm Pitch, 0.4-mm Height
- ESD Performance Tested per JESD 22
 - 2-kV HBM and 1-kV CDM

2 Applications

- Computing
- SSD
- Tablets
- Wearables
- EPOS

3 Description

The TPS22925 product family consists of four devices: TPS22925B, TPS22925BN, TPS22925C, and TPS22925CN. Each device is a 9-mΩ, single-channel load switch with a controlled slew rate.

The devices contain an N-channel MOSFET that can operate over an input voltage range of 0.65 V to 3.6 V and can support a maximum continuous current of 3 A. This continuous current enables the devices to be used across multiple designs and end equipments. Each of the TPS22925 devices provides reverse current blocking when disabled allowing for power supply protection and power multiplexing capabilities.

The controlled rise time for the device greatly reduces inrush current caused by large bulk load capacitances, thereby reducing or eliminating power supply droop. When operating with an input voltage of 3.6 V, the TPS22925Bx devices feature a 97 μs rise time and the TPS22925Cx devices feature an 810 μs rise time.

The TPS22925 family of devices can help reduce the total solution size by offering an optional integrated, 150-Ω pull-down resistor for quick output discharge (QOD) when the switch is turned off. Each of the TPS22925 devices is available in a 0.9 mm x 1.4 mm, 0.5-mm pitch, 0.4-mm height 6-pin wafer chip scale package (WCSP) allowing for smaller, more integrated designs. The WCSP and 9 mΩ of on-resistance allow use in space constrained, battery powered applications. The device is characterized for operation over the free-air temperature range of -40°C to +105°C.

Device Information⁽¹⁾

PART NUMBER	PACKAGE	BODY SIZE (NOM)
TPS22925B	DSBGA (6)	0.90 mm x 1.40 mm
TPS22925BN		
TPS22925C		
TPS22925CN		

(1) For all available packages, see the orderable addendum at the end of the data sheet.

Simplified Application

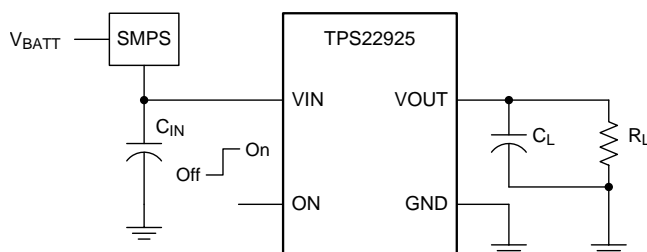

On-Resistance vs Input Voltage

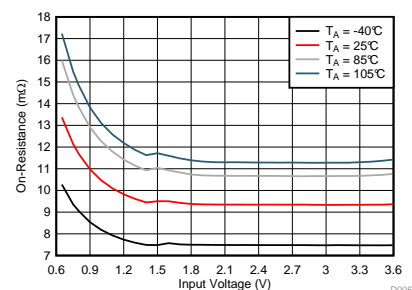

Table of Contents

<p>1 Features 1</p> <p>2 Applications 1</p> <p>3 Description 1</p> <p>4 Revision History..... 2</p> <p>5 Device Comparison Table..... 3</p> <p>6 Pin Configuration and Functions 3</p> <p>7 Specifications..... 4</p> <p style="padding-left: 20px;">7.1 Absolute Maximum Ratings 4</p> <p style="padding-left: 20px;">7.2 ESD Ratings..... 4</p> <p style="padding-left: 20px;">7.3 Recommended Operating Conditions 4</p> <p style="padding-left: 20px;">7.4 Thermal Information 4</p> <p style="padding-left: 20px;">7.5 Electrical Characteristics..... 5</p> <p style="padding-left: 20px;">7.6 Switching Characteristics 6</p> <p style="padding-left: 20px;">7.7 Typical Characteristics 8</p> <p style="padding-left: 20px;">7.8 Typical Characteristics 11</p> <p>8 Detailed Description 13</p> <p style="padding-left: 20px;">8.1 Overview 13</p> <p style="padding-left: 20px;">8.2 Functional Block Diagram 13</p>	<p style="padding-left: 20px;">8.3 Feature Description..... 13</p> <p style="padding-left: 20px;">8.4 Device Functional Modes..... 15</p> <p>9 Application and Implementation 16</p> <p style="padding-left: 20px;">9.1 Application Information..... 16</p> <p style="padding-left: 20px;">9.2 Typical Application 18</p> <p>10 Power Supply Recommendations 19</p> <p>11 Layout..... 20</p> <p style="padding-left: 20px;">11.1 Layout Guidelines 20</p> <p style="padding-left: 20px;">11.2 Layout Example 20</p> <p>12 Device and Documentation Support 21</p> <p style="padding-left: 20px;">12.1 Documentation Support 21</p> <p style="padding-left: 20px;">12.2 Receiving Notification of Documentation Updates 21</p> <p style="padding-left: 20px;">12.3 Community Resources..... 21</p> <p style="padding-left: 20px;">12.4 Trademarks 21</p> <p style="padding-left: 20px;">12.5 Electrostatic Discharge Caution..... 21</p> <p style="padding-left: 20px;">12.6 Glossary 21</p> <p>13 Mechanical, Packaging, and Orderable Information 21</p>
--	--

4 Revision History

Changes from Revision C (February 2016) to Revision D	Page
<ul style="list-style-type: none"> • Made changes to the ESD Ratings table 4 	4
<p>Changes from Revision B (January 2016) to Revision C</p>	Page
<ul style="list-style-type: none"> • Made changes to Device Comparison Table 1 	1
<p>Changes from Revision A (December 2015) to Revision B</p>	Page
<ul style="list-style-type: none"> • Deleted the STATUS column from the Device Comparison Table 3 	3
<p>Changes from Original (November 2015) to Revision A</p>	Page
<ul style="list-style-type: none"> • Updated document status from <i>Product Preview</i> to <i>Production Data</i> 1 	1

5 Device Comparison Table

DEVICE	QOD	R_{ON} (m Ω) at $V_{IN} = 3.6$ V	t_R (μ s) at $V_{IN} = 3.6$ V	MAXIMUM OUTPUT CURRENT I_{MAX} (A)	ENABLE (ON PIN)
TPS22925B	Yes	9.2	97	3	Active High
TPS22925BN	No				
TPS22925C	Yes		810		
TPS22925CN	No				

6 Pin Configuration and Functions

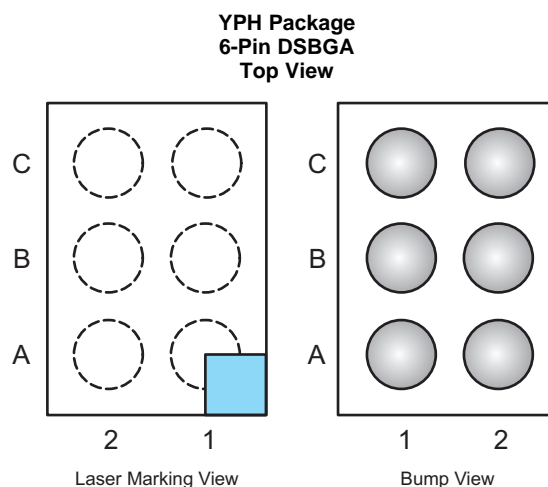

Pin Assignments

C	GND	ON
B	VOUT	VIN
A	VOUT	VIN
	1	2

Pin Functions

PIN		TYPE	DESCRIPTION
NAME	NO.		
GND	C1	GND	Ground
ON	C2	I	Switch control input. Active high. Do not leave floating.
VIN	A2	I	Switch input; bypass this input with a ceramic capacitor to ground. See the Application Information section for more detail.
	B2		
VOUT	A1	O	Switch output
	B1		

7 Specifications

7.1 Absolute Maximum Ratings

over operating free-air temperature range (unless otherwise noted)⁽¹⁾

		MIN	MAX	UNIT
V _{IN, ON}	Input voltage	-0.3	4	V
V _{OUT}	Output voltage	-0.3	4	V
I _{MAX}	Maximum continuous switch current at T _A = 60°C		3	A
I _{PLS}	Maximum pulsed switch current, 100-μs pulse, 2% duty cycle		4	A
T _J	Junction temperature		125	°C
T _{stg}	Storage temperature	-65	150	°C

- (1) Stresses beyond those listed under *Absolute Maximum Ratings* may cause permanent damage to the device. These are stress ratings only, which do not imply functional operation of the device at these or any other conditions beyond those indicated under *Recommended Operating Conditions*. Exposure to absolute-maximum-rated conditions for extended periods may affect device reliability.

7.2 ESD Ratings

		VALUE	UNIT
V _(ESD)	Electrostatic discharge	Human-body model (HBM), per ANSI/ESDA/JEDEC JS-001 ⁽¹⁾	±2000
		Charged-device model (CDM), per JEDEC specification JESD22-C101 ⁽²⁾	±1000

- (1) JEDEC document JEP155 states that 500-V HBM allows safe manufacturing with a standard ESD control process. Manufacturing with less than 500-V HBM is possible with the necessary precautions.
- (2) JEDEC document JEP157 states that 250-V CDM allows safe manufacturing with a standard ESD control process. Manufacturing with less than 250-V CDM is possible with the necessary precautions.

7.3 Recommended Operating Conditions

over operating free-air temperature range (unless otherwise noted)

		MIN	MAX	UNIT
V _{IN}	Input voltage	0.65	3.6	V
V _{OUT}	Output voltage	0	3.6	V
V _{IH}	High-level input voltage, ON	0.9	3.6	V
V _{IL}	Low-level input voltage, ON	0	0.45	V
C _{IN}	Input capacitance	1		μF
T _A	Operating free-air temperature	-40	105	°C

7.4 Thermal Information

THERMAL METRIC ⁽¹⁾	TPS22925xx		UNIT
	YPH (DSBGA)		
	6 PINS		
R _{θJA}	Junction-to-ambient thermal resistance	110.9	°C/W
R _{θJC(top)}	Junction-to-case (top) thermal resistance	1.2	°C/W
R _{θJB}	Junction-to-board thermal resistance	30.4	°C/W
ψ _{JT}	Junction-to-top characterization parameter	0.8	°C/W
ψ _{JB}	Junction-to-board characterization parameter	30.4	°C/W

- (1) For more information about traditional and new thermal metrics, see the *Semiconductor and IC Package Thermal Metrics* application report, [SPRA953](#).

7.5 Electrical Characteristics

over operating free-air temperature range (unless otherwise noted). Typical values are for $T_A = 25^\circ\text{C}$.

PARAMETER	TEST CONDITIONS	T_A	MIN	TYP	MAX	UNIT
$I_{Q,VIN}$	Quiescent current $V_{ON} = 3.6\text{ V}$, $I_{OUT} = 0\text{ A}$	$V_{IN} = 3.6\text{ V}$	$-40^\circ\text{C to }+85^\circ\text{C}$	29	71	μA
			$-40^\circ\text{C to }+105^\circ\text{C}$		84	
		$V_{IN} = 2.5\text{ V}$	$-40^\circ\text{C to }+85^\circ\text{C}$	28	67	
			$-40^\circ\text{C to }+105^\circ\text{C}$		79	
		$V_{IN} = 1.8\text{ V}$	$-40^\circ\text{C to }+85^\circ\text{C}$	26	65	
			$-40^\circ\text{C to }+105^\circ\text{C}$		76	
		$V_{IN} = 1.2\text{ V}$	$-40^\circ\text{C to }+85^\circ\text{C}$	20	55	
			$-40^\circ\text{C to }+105^\circ\text{C}$		66	
		$V_{IN} = 1\text{ V}$	$-40^\circ\text{C to }+85^\circ\text{C}$	16	50	
			$-40^\circ\text{C to }+105^\circ\text{C}$		60	
		$V_{IN} = 0.65\text{ V}$	$-40^\circ\text{C to }+85^\circ\text{C}$	10	39	
			$-40^\circ\text{C to }+105^\circ\text{C}$		49	
$I_{SD,VIN}$	VIN shutdown current $V_{ON} = 0\text{ V}$, $V_{OUT} = 0\text{ V}$	$V_{IN} = 3.6\text{ V}$	$-40^\circ\text{C to }+85^\circ\text{C}$	0.5	5	μA
			$-40^\circ\text{C to }+105^\circ\text{C}$		9	
		$V_{IN} = 2.5\text{ V}$	$-40^\circ\text{C to }+85^\circ\text{C}$	0.5	4	
			$-40^\circ\text{C to }+105^\circ\text{C}$		6	
		$V_{IN} = 1.8\text{ V}$	$-40^\circ\text{C to }+85^\circ\text{C}$	0.5	4	
			$-40^\circ\text{C to }+105^\circ\text{C}$		6	
		$V_{IN} = 1.2\text{ V}$	$-40^\circ\text{C to }+85^\circ\text{C}$	0.5	3	
			$-40^\circ\text{C to }+105^\circ\text{C}$		5	
		$V_{IN} = 1\text{ V}$	$-40^\circ\text{C to }+85^\circ\text{C}$	0.5	3	
			$-40^\circ\text{C to }+105^\circ\text{C}$		5	
		$V_{IN} = 0.65\text{ V}$	$-40^\circ\text{C to }+85^\circ\text{C}$	0.5	3	
			$-40^\circ\text{C to }+105^\circ\text{C}$		5	
I_{ON}	ON pin input leakage current $0.9\text{ V} \leq V_{ON} \leq 3.6\text{ V}$	$-40^\circ\text{C to }+105^\circ\text{C}$			0.1	μA
$I_{RC,VIN}$	Reverse current when disabled $V_{IN} = V_{ON} = 0\text{ V}$, $V_{OUT} = 3.6\text{ V}$	$-40^\circ\text{C to }+85^\circ\text{C}$		-0.2	-2.5	μA
		$-40^\circ\text{C to }+105^\circ\text{C}$			-6	
R_{ON}	On-resistance $I_{OUT} = -200\text{ mA}$	$V_{IN} = 3.6\text{ V}$	25°C	9.2	13	$\text{m}\Omega$
			$-40^\circ\text{C to }+85^\circ\text{C}$		15	
			$-40^\circ\text{C to }+105^\circ\text{C}$		16	
		$V_{IN} = 2.5\text{ V}$	25°C	9.2	13	
			$-40^\circ\text{C to }+85^\circ\text{C}$		15	
			$-40^\circ\text{C to }+105^\circ\text{C}$		16	
		$V_{IN} = 1.8\text{ V}$	25°C	9.2	13	
			$-40^\circ\text{C to }+85^\circ\text{C}$		15	
			$-40^\circ\text{C to }+105^\circ\text{C}$		16	
		$V_{IN} = 1.2\text{ V}$	25°C	9.5	14	
			$-40^\circ\text{C to }+85^\circ\text{C}$		16	
			$-40^\circ\text{C to }+105^\circ\text{C}$		17	
		$V_{IN} = 1\text{ V}$	25°C	10.2	15	
			$-40^\circ\text{C to }+85^\circ\text{C}$		17	
			$-40^\circ\text{C to }+105^\circ\text{C}$		18	
		$V_{IN} = 0.65\text{ V}$	25°C	13.1	20	
			$-40^\circ\text{C to }+85^\circ\text{C}$		23	
			$-40^\circ\text{C to }+105^\circ\text{C}$		25	

TPS22925

SLVS840D –NOVEMBER 2015–REVISED AUGUST 2016

Electrical Characteristics (continued)

over operating free-air temperature range (unless otherwise noted). Typical values are for $T_A = 25^\circ\text{C}$.

PARAMETER	TEST CONDITIONS	T_A	MIN	TYP	MAX	UNIT
V_{HYS} ON pin hysteresis	$V_{IN} = 3.6\text{ V}$	25°C		86		mV
	$V_{IN} = 2.5\text{ V}$			83		
	$V_{IN} = 1.8\text{ V}$			82		
	$V_{IN} = 1.2\text{ V}$			80		
	$V_{IN} = 1\text{ V}$			79		
	$V_{IN} = 0.65\text{ V}$			79		
$R_{PD}^{(1)}$ Output pull-down resistance	$V_{IN} = V_{OUT} = 3.6\text{ V}$, $V_{ON} = 0\text{ V}$	-40°C to +85°C		150	205	Ω
		-40°C to +105°C			215	

(1) Applies to TPS22925B and TPS22925C only.

7.6 Switching Characteristics⁽¹⁾

over operating free-air temperature range (unless otherwise noted) $V_{ON} = 3.6\text{ V}$, $R_L = 10\ \Omega$, $C_{IN} = 1\ \mu\text{F}$, $C_L = 0.1\ \mu\text{F}$, $T_A = 25^\circ\text{C}$

PARAMETER	TEST CONDITIONS	TYP (TPS22925Bx)	TYP (TPS22925Cx)	UNIT
t_{ON} Turnon time	$V_{IN} = 3.6\text{ V}$	110	900	μs
	$V_{IN} = 1.8\text{ V}$	94	730	
	$V_{IN} = 0.65\text{ V}$	86	620	
t_{OFF} Turnoff time	$V_{IN} = 3.6\text{ V}$	3	3	μs
	$V_{IN} = 1.8\text{ V}$	2.7	2.7	
	$V_{IN} = 0.65\text{ V}$	10.9	10.9	
t_R Output voltage rise time	$V_{IN} = 3.6\text{ V}$	97	810	μs
	$V_{IN} = 1.8\text{ V}$	61	520	
	$V_{IN} = 0.65\text{ V}$	36	300	
t_F Output voltage fall time	$V_{IN} = 3.6\text{ V}$	2.2	2.2	μs
	$V_{IN} = 1.8\text{ V}$	2.1	2.1	
	$V_{IN} = 0.65\text{ V}$	3.6	3.6	
t_D Delay time	$V_{IN} = 3.6\text{ V}$	64	500	μs
	$V_{IN} = 1.8\text{ V}$	66	490	
	$V_{IN} = 0.65\text{ V}$	68	470	

(1) Turn-off time and fall time are dependent on the time constant at the load. For TPS22925BN and TPS22925CN, there is no QOD. The time constant is $R_L \times C_L$. For TPS22925B and TPS22925C, internal pull-down resistor R_{PD} is enabled when the switch is disabled. The time constant is $(R_{PD} \parallel R_L) \times C_L$.

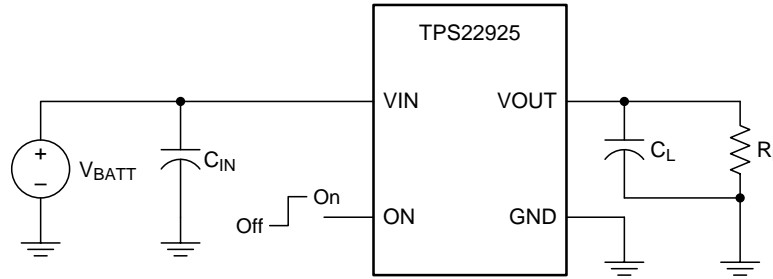
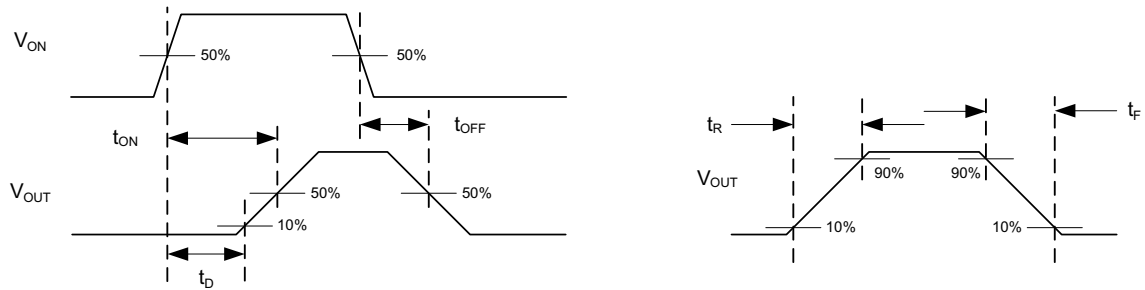

Figure 1. Timing Test Circuit



Rise times and fall times of the control signal is 100 ns.

Figure 2. Timing Waveforms

7.7 Typical Characteristics

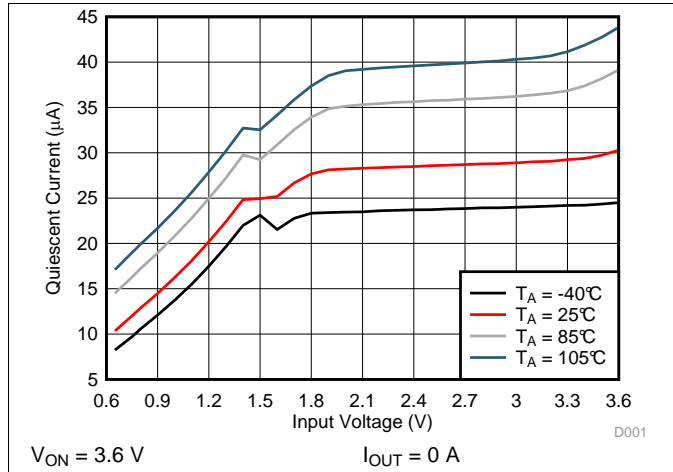

Figure 3. Quiescent Current vs Input Voltage

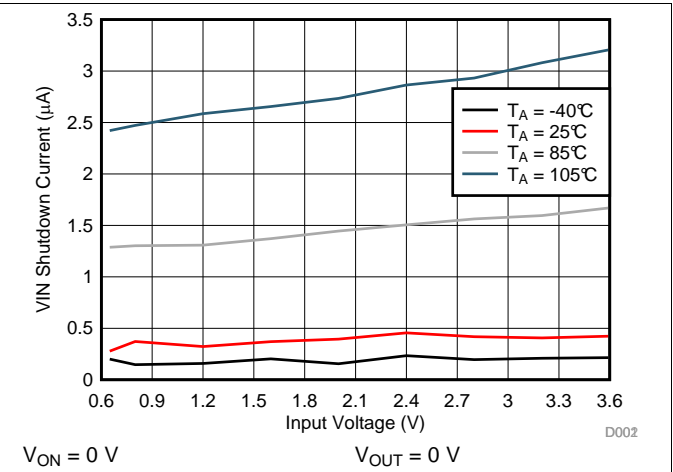

Figure 4. Input Shutdown Current vs Input Voltage

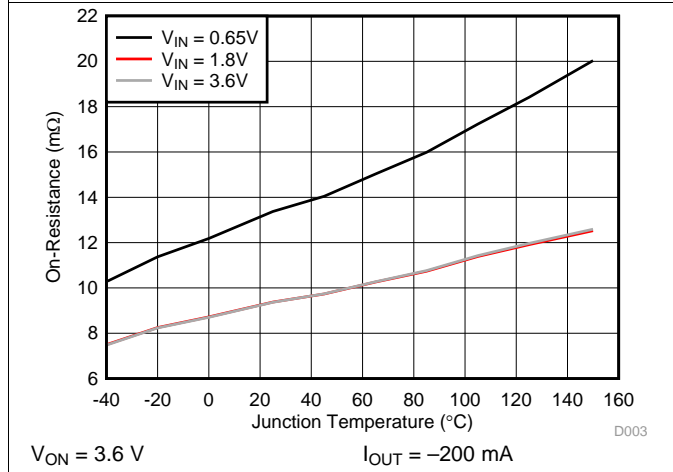

Figure 5. On-Resistance vs Temperature

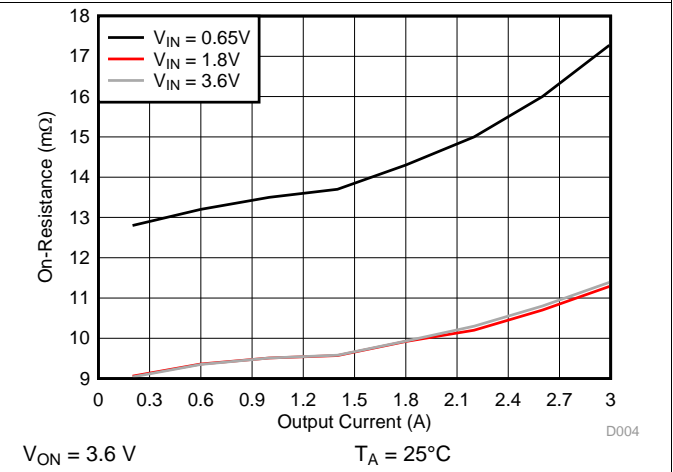

Figure 6. On-Resistance vs Output Current

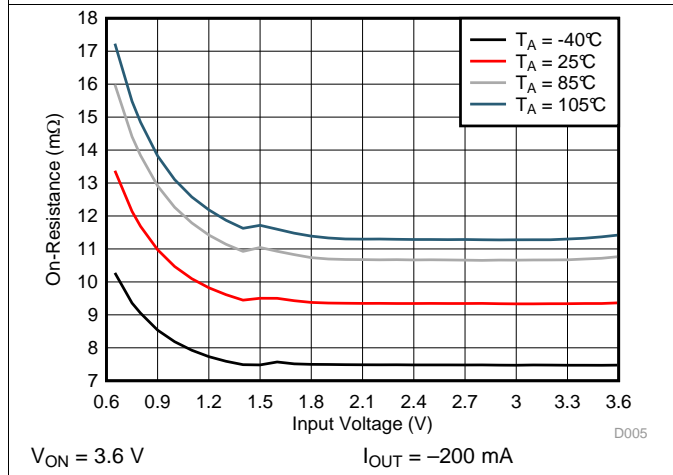

Figure 7. On-Resistance vs Input Voltage

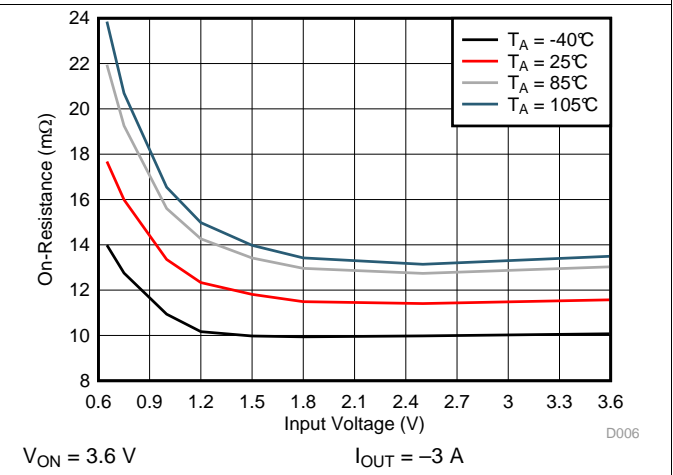

Figure 8. On-Resistance vs Input Voltage

Typical Characteristics (continued)

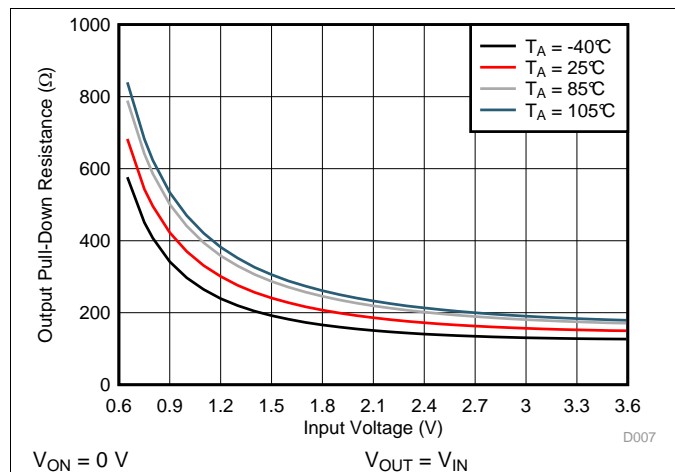

Figure 9. Output Pull-Down Resistance vs Input Voltage

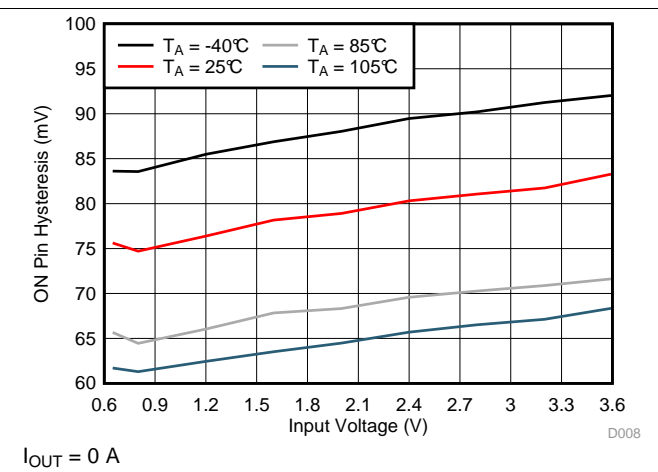

Figure 10. Hysteresis vs Input Voltage

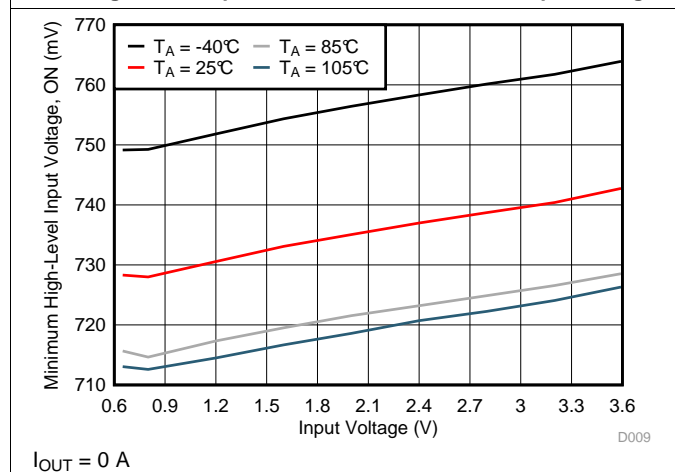

Figure 11. High-Level Input Voltage vs Input Voltage

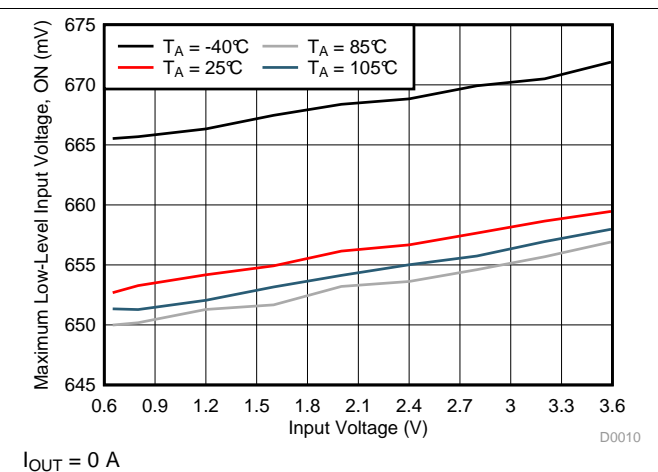

Figure 12. Low-Level Input Voltage vs Input Voltage

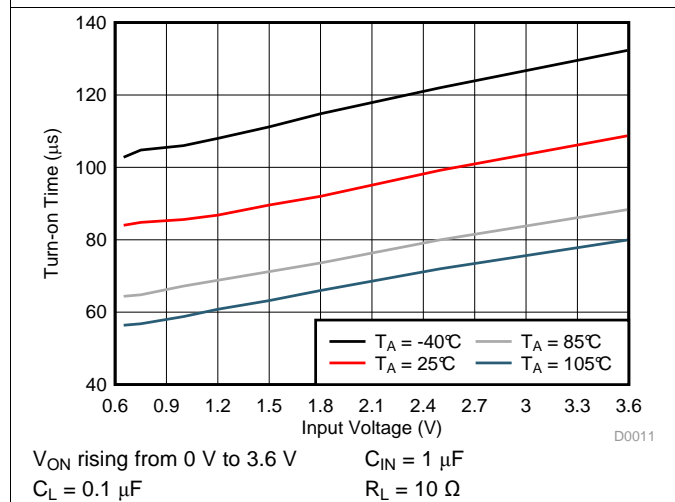

Figure 13. Turn-on Time vs Input Voltage (TPS22925Bx)

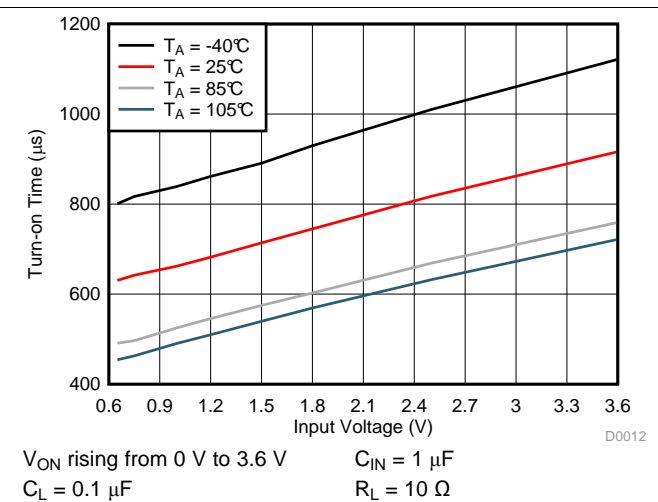

Figure 14. Turn-on Time vs Input Voltage (TPS22925Cx)

Typical Characteristics (continued)

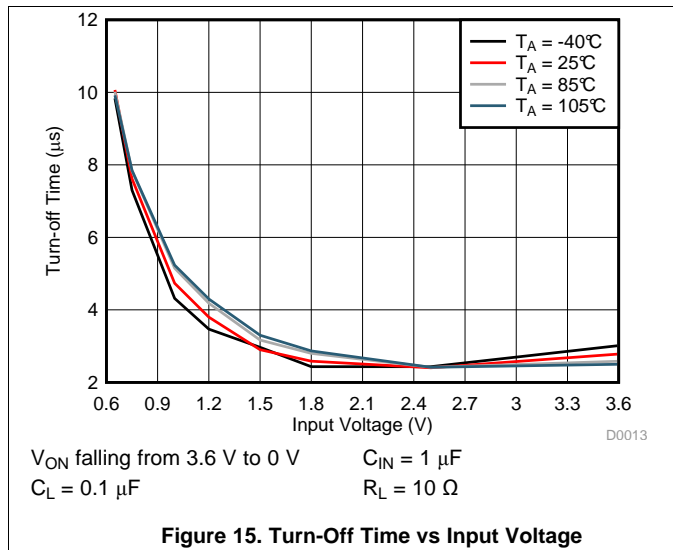

Figure 15. Turn-Off Time vs Input Voltage

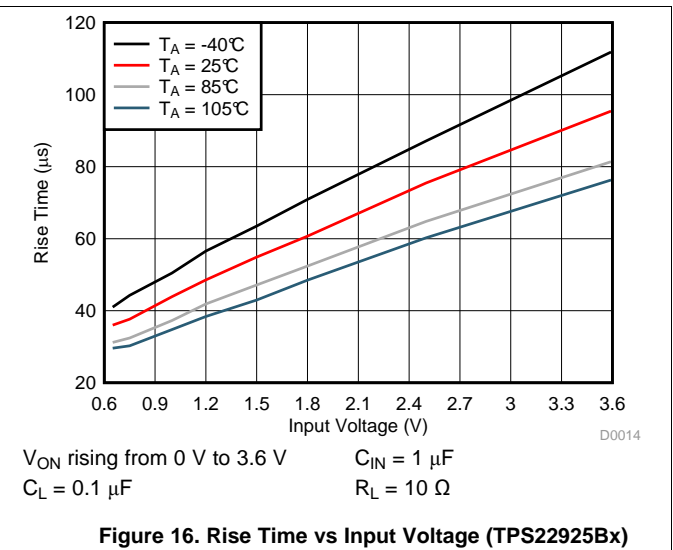

Figure 16. Rise Time vs Input Voltage (TPS22925Bx)

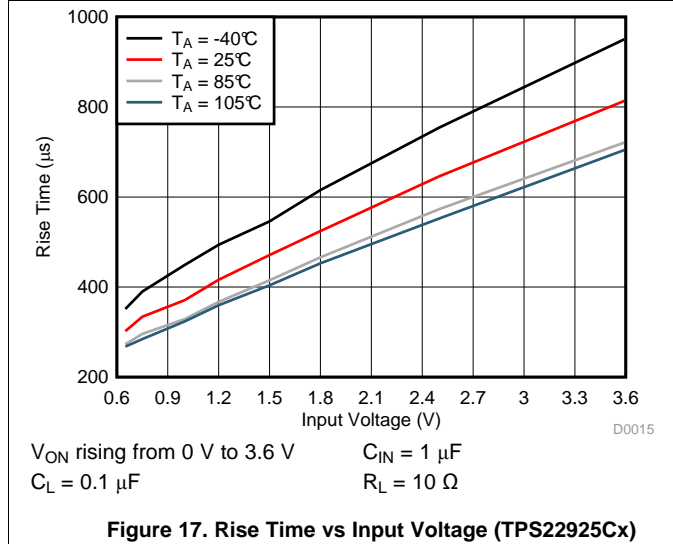

Figure 17. Rise Time vs Input Voltage (TPS22925Cx)

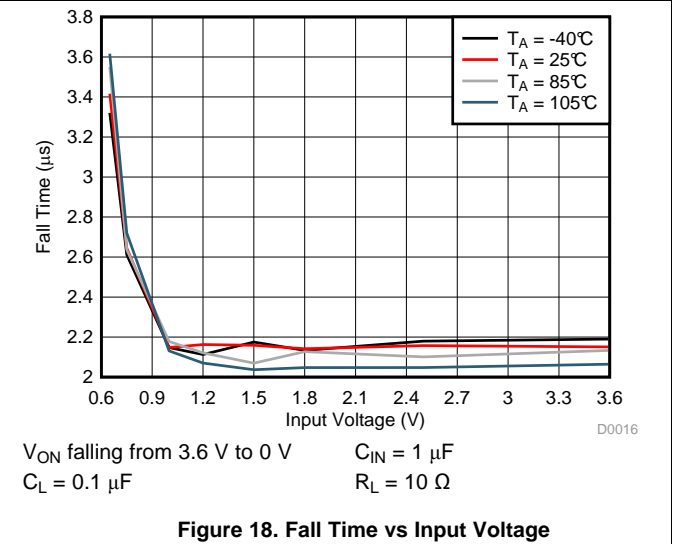

Figure 18. Fall Time vs Input Voltage

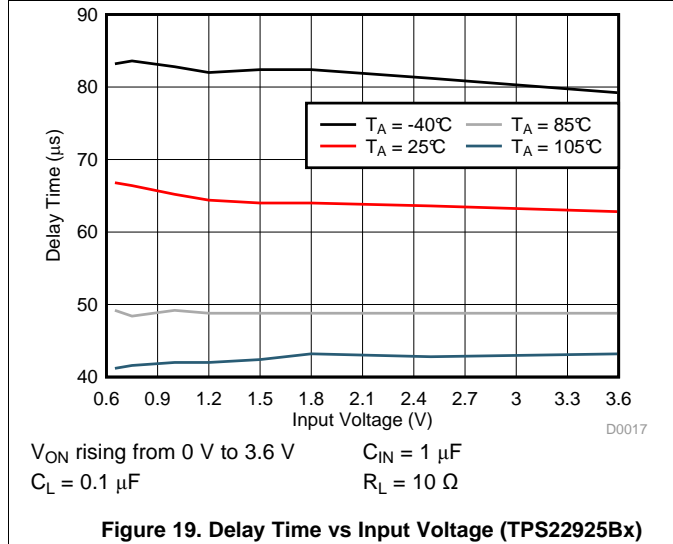

Figure 19. Delay Time vs Input Voltage (TPS22925Bx)

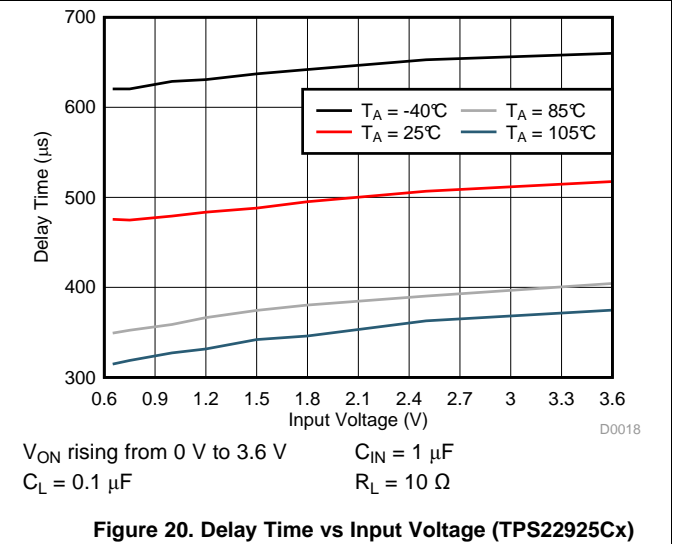

Figure 20. Delay Time vs Input Voltage (TPS22925Cx)

7.8 Typical Characteristics

$C_{IN} = 1 \mu F$, $C_L = 0.1 \mu F$, $R_L = 10 \Omega$, $T_A = 25^\circ C$

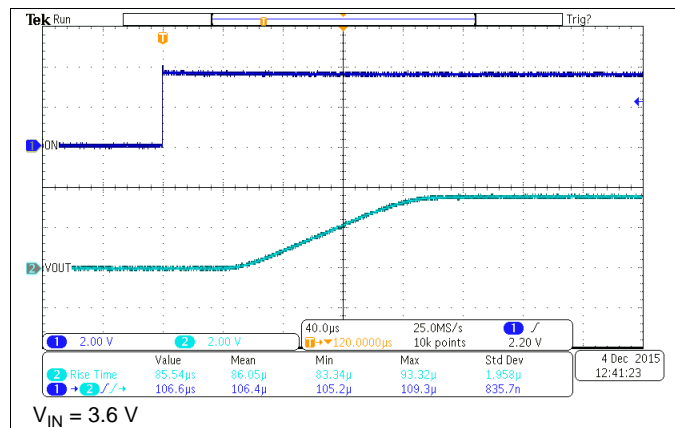

Figure 21. Turnon Response (TPS22925Bx)

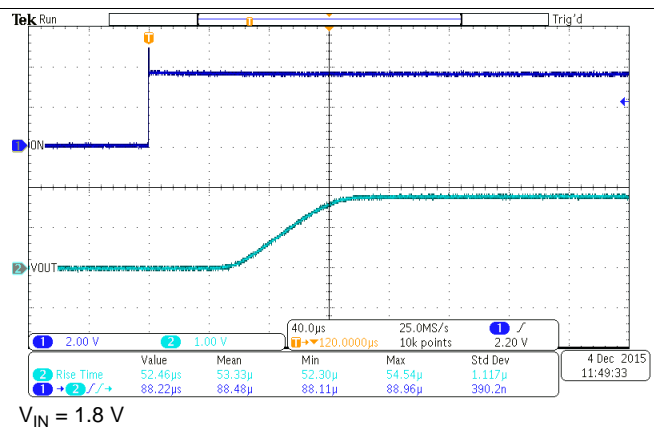

Figure 22. Turnon Response (TPS22925Bx)

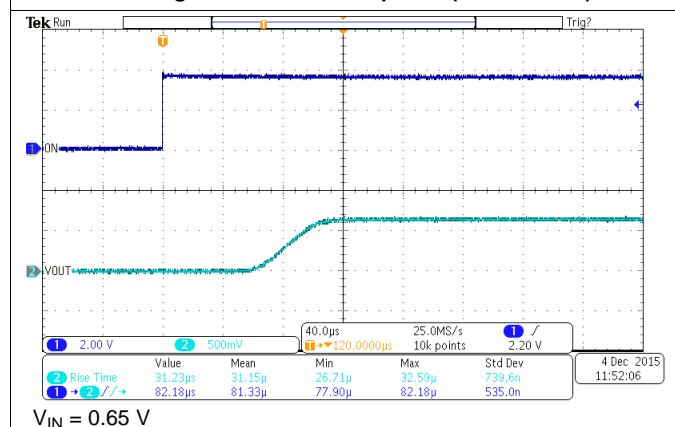

Figure 23. Turnon Response (TPS22925Cx)

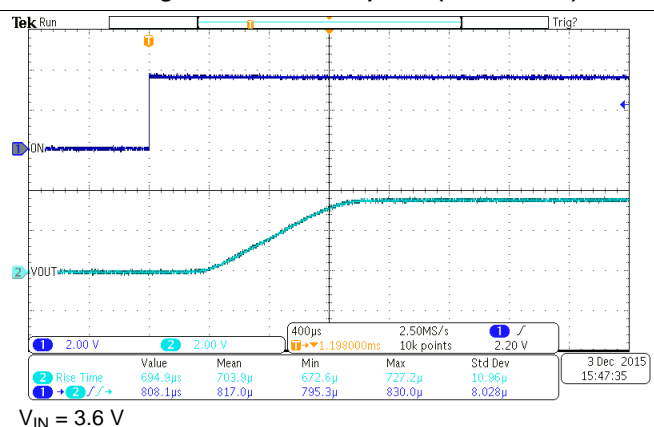

Figure 24. Turnon Response (TPS22925Cx)

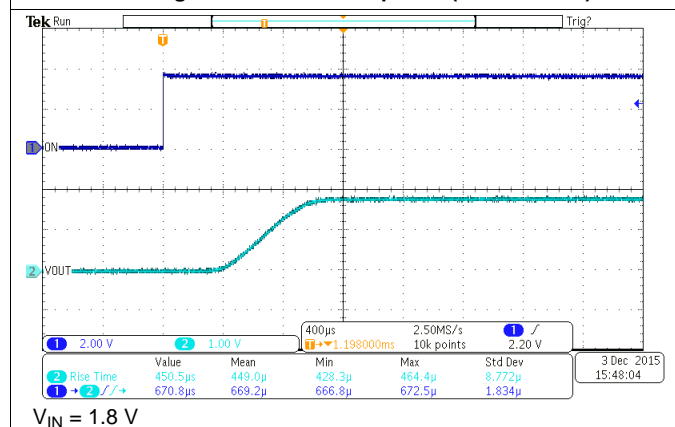

Figure 25. Turnon Response (TPS22925Cx)

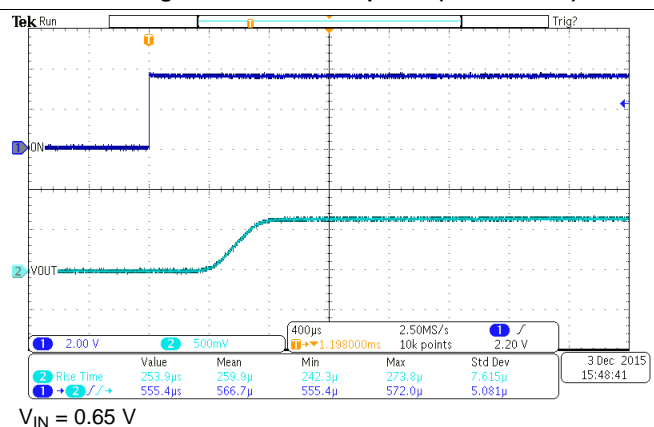

Figure 26. Turnon Response (TPS22925Cx)

Typical Characteristics (continued)

$C_{IN} = 1 \mu\text{F}$, $C_L = 0.1 \mu\text{F}$, $R_L = 10 \Omega$, $T_A = 25^\circ\text{C}$

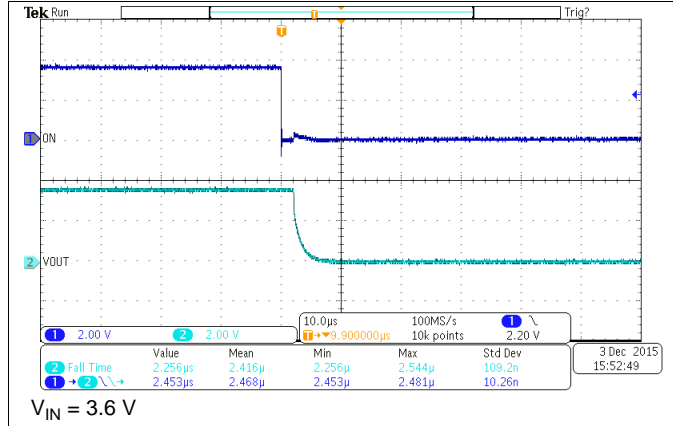

Figure 27. Turnoff Response (TPS22925xx)

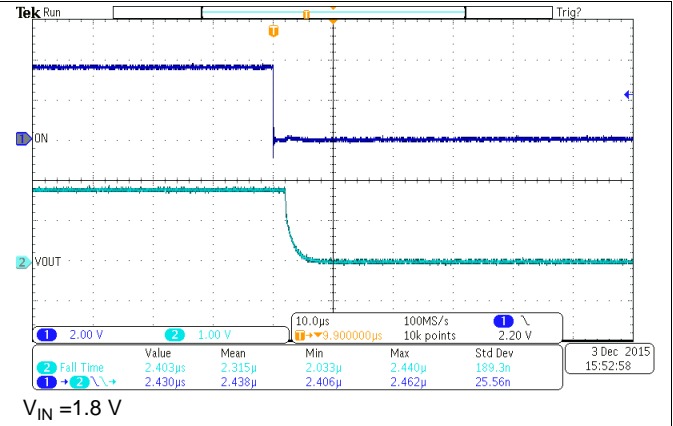

Figure 28. Turnoff Response (TPS22925xx)

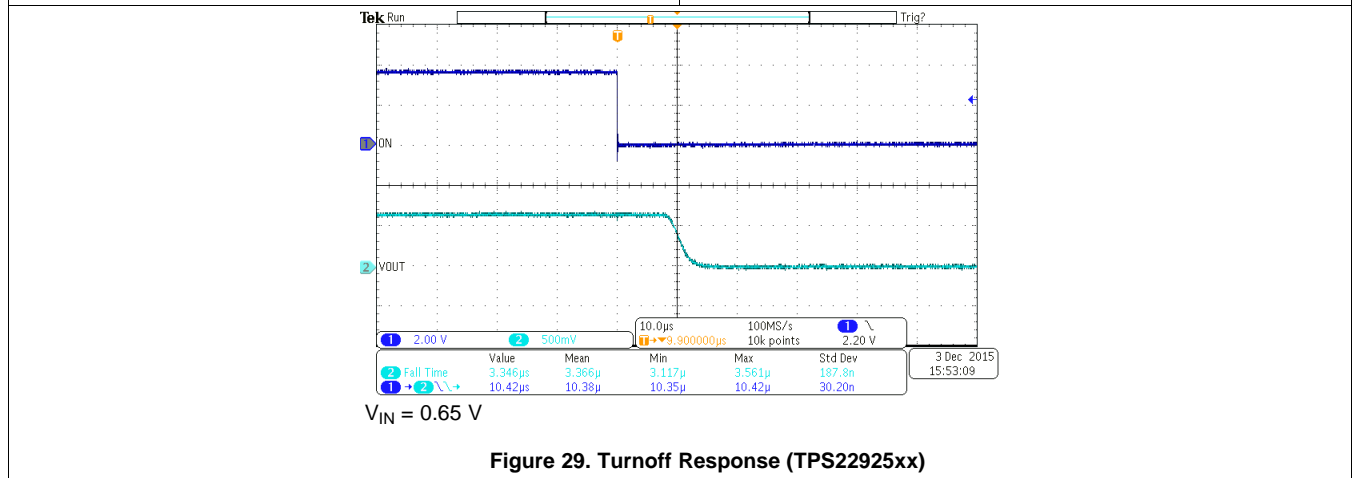

Figure 29. Turnoff Response (TPS22925xx)

8 Detailed Description

8.1 Overview

The TPS22925 is a single channel, 3-A load switch in a WCSP-6 package. This device implements an N-channel MOSFET with a controlled rise time for applications that need to limit inrush current. The device is also designed to have low leakage current during off state. This prevents downstream circuits from pulling high standby current from the supply. The TPS22925 provides reverse current blocking when the power switch is disabled. Integrated control logic, driver, and output discharge FET eliminates the need for additional external components, which reduces solution size and bill of material (BOM) count.

8.2 Functional Block Diagram

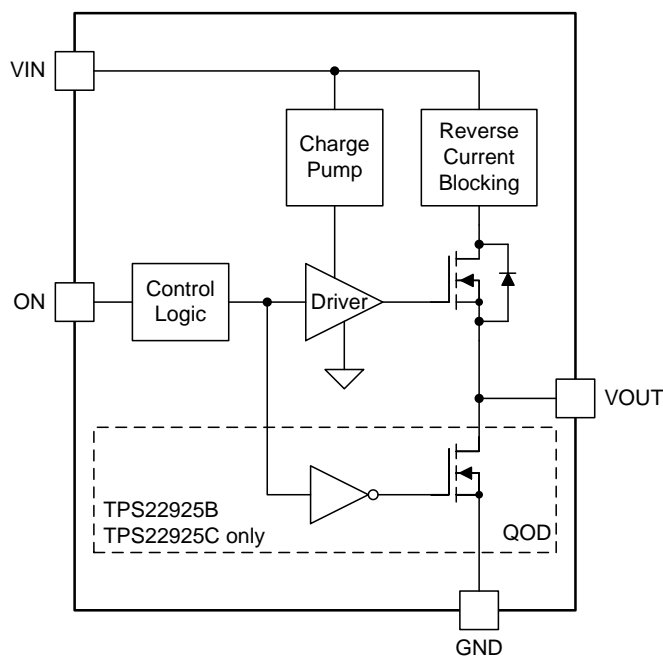

8.3 Feature Description

8.3.1 ON and OFF Control

The ON pin controls the state of the switch. Asserting the ON pin high enables the switch. The ON pin is compatible with GPIOs of 1.5 V and above.

8.3.2 Quick Output Discharge (QOD) (TPS22925B and TPS22925C Only)

When the switch is disabled, a discharge path is enabled between the output and ground with a typical resistance of 150 Ω . The resistance pulls down the output and prevents it from floating when the device is disabled.

Feature Description (continued)

8.3.3 Reverse Current Blocking

The reverse current blocking feature prevents current flow from the VOUT pin to the VIN pin when the TPS22925 devices are disabled. This feature is particularly useful when the output of the device needs to be driven by another voltage source after TPS22925 is disabled (for example in a power multiplexer application). In order for this feature to work, the TPS22925 must be disabled and either of the following conditions must be met:

- $V_{IN} \geq 0.65\text{ V}$ or
- $V_{OUT} \geq 0.65\text{ V}$

Figure 30 describes the ideal behavior of reverse current blocking circuit in TPS22925 devices where

- I_{VIN} is the current through the VIN pin
- V_{SRC} is the input voltage applied to the device
- V_{FORCE} is the external voltage source forced at the VOUT pin
- I_{OUT} is the output load current

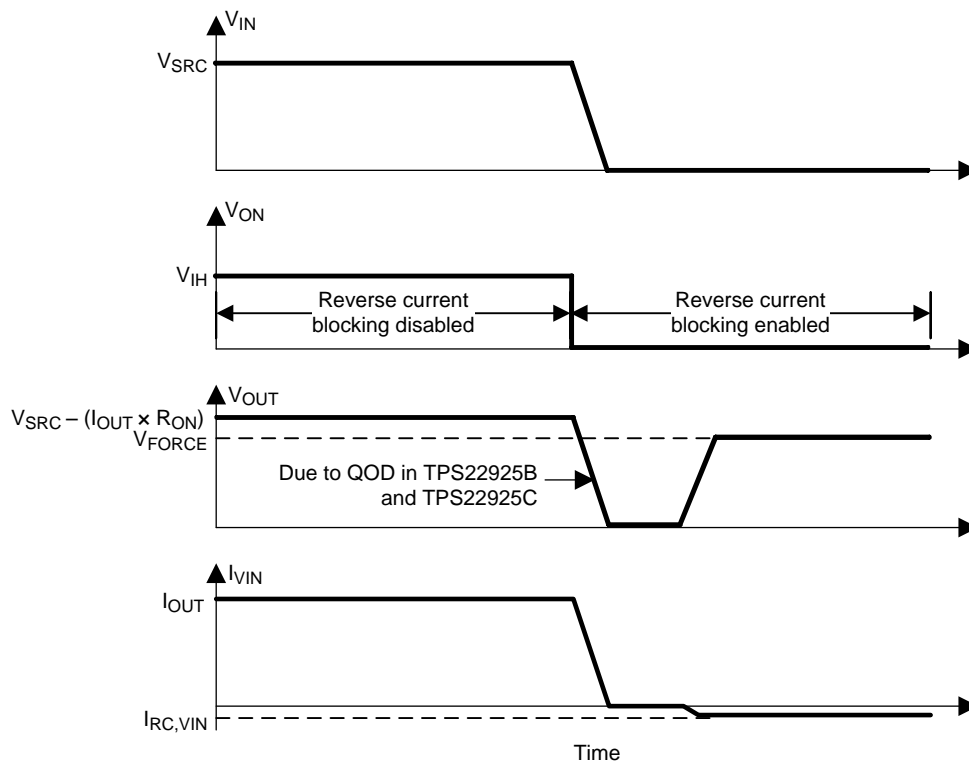

Figure 30. Reverse Current Blocking

After the device is disabled via the ON pin and VOUT is forced to an external voltage (V_{FORCE}), less than $6\ \mu\text{A}$ of current flows from the VOUT pin to the VIN pin. This limitation prevents any extra current loading on the voltage source supplying the V_{FORCE} voltage.

8.4 Device Functional Modes

Table 1 shows the function table for the TPS22925xx devices.

Table 1. Function Table

ON	VIN to VOUT	OUTPUT DISCHARGE⁽¹⁾
L	OFF	ENABLED
H	ON	DISABLED

(1) This feature is in the TPS22925B and TPS22925C only (not in the TPS22925BN and TPS22925CN).

9 Application and Implementation

NOTE

Information in the following applications sections is not part of the TI component specification, and TI does not warrant its accuracy or completeness. TI's customers are responsible for determining suitability of components for their purposes. Customers should validate and test their design implementation to confirm system functionality.

9.1 Application Information

The TPS22925 device is a 9-m Ω , single-channel load switch with a controlled slew rate. This design example describes a device containing an N-channel MOSFET that operates at an input voltage range of 3.6 V and supports a maximum continuous current of 3 A. The device provides reverse current blocking when disabled allowing for power supply protection and power multiplexing capabilities.

9.1.1 VIN to VOUT Voltage Drop

The VIN pin to VOUT pin voltage drop in the device is determined by the R_{ON} of the device and the load current. The on-resistance of the device depends upon the VIN condition of the device. See the on-resistance specification in the [Electrical Characteristics](#) table. After the on-resistance of the device is determined based upon the input voltage conditions, use [Equation 1](#) to calculate the VIN-to-VOUT voltage drop.

$$\Delta V = I_L \times R_{ON}$$

where

- ΔV is the voltage drop from the VIN pin to the VOUT pin
- I_L is the load current
- R_{ON} is the on-resistance of the device for a specific input voltage
- Choose an appropriate I_L so that the maximum current (I_{MAX}) specification of the device is not violated (1)

9.1.2 Input Capacitor (C_{IN})

To limit the voltage drop on the input supply caused by transient inrush currents when the switch turns on into a discharged load capacitor, place a capacitor between VIN and GND close to the pins. A 1- μ F ceramic capacitor, C_{IN} , is usually sufficient. Higher values of C_{IN} can be used to further reduce the voltage drop.

9.1.3 Load Capacitor (C_L)

A C_{IN} to C_L ratio of 10-to-1 is recommended for minimizing the input voltage dip caused by inrush currents during startup.

Application Information (continued)

9.1.4 Standby Power Reduction

Any end equipment that is being powered from the battery has a need to reduce current consumption in order to maintain the battery charge for a longer time. TPS22925 devices help to accomplish this reduction by turning off the supply to the modules that are in standby state and hence significantly reducing the leakage current overhead of the standby modules. See [Figure 31](#).

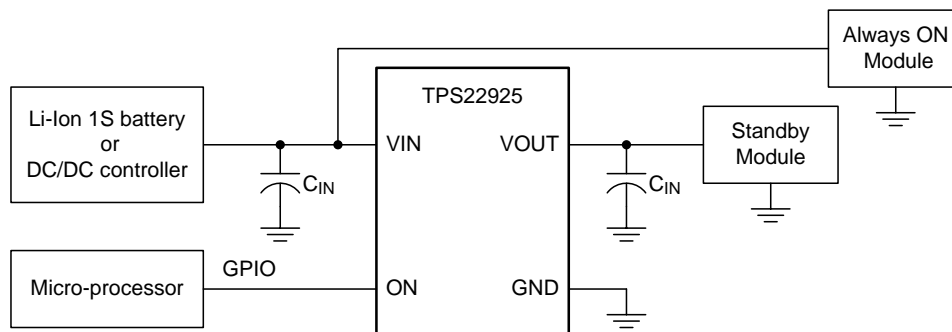

Figure 31. Standby Power Reduction

9.1.5 Power Multiplexing

[Figure 32](#) shows a power multiplexing application using two TPS22925xN devices. Use the non-QOD version in order to maintain the output voltage. Configure the GPIO control from the microprocessor unit as break-before-make (BBM).

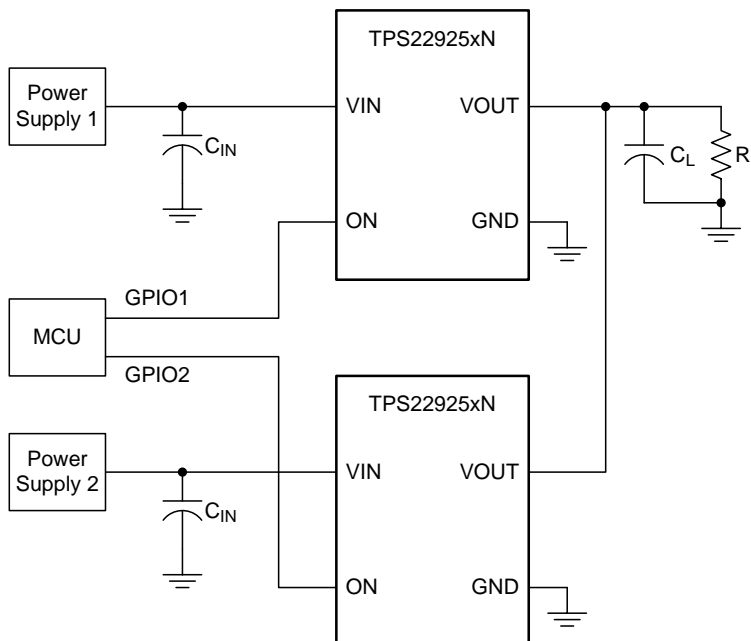

Figure 32. Power Multiplexing with Two TPS22925xN Devices

Application Information (continued)

9.1.6 Thermal Considerations

Restrict the maximum junction temperature lower than 125°C. Use Equation 2 to calculate the maximum allowable dissipation, $P_{D(max)}$ for a given output load current and ambient temperature.

$$P_{D(max)} = \frac{T_{J(max)} - T_A}{R_{\theta JA}}$$

where

- $P_{D(max)}$ is the maximum allowable power dissipation
- $T_{J(max)}$ is the maximum allowable junction temperature
- T_A is the ambient temperature of the device
- $R_{\theta JA}$ is the junction-to-air thermal impedance

(2)

NOTE

The $R_{\theta JA}$ parameter is highly dependent upon board layout. (See the [Thermal Information](#) table)

9.2 Typical Application

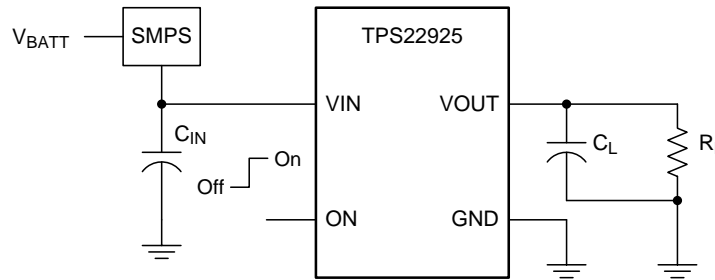

Figure 33. Typical Application Schematic

9.2.1 Design Requirements

For this design example, use the values listed in Table 2 as the input parameters.

Table 2. Design Parameters

DESIGN PARAMETER	EXAMPLE VALUE
V_{IN}	3.6 V
C_L	1 μ F
Maximum Acceptable Inrush Current	40 mA

9.2.2 Detailed Design Procedure

9.2.2.1 Managing Inrush Current

When the switch is enabled, the V_{IN} capacitors must be charged up from 0 V to V_{IN} . This charge arrives in the form of inrush current. Calculate the inrush current using Equation 3.

$$I_{INRUSH} = C_L \times \frac{dv}{dt}$$

where

- I_{INRUSH} is the inrush current
- C_L is the load capacitance
- dv/dt is the output slew rate

(3)

The TPS22925Bx and TPS22925Cx have different controlled rise time. TPS22925Bx has shorter rise time than TPS22925Cx. In the application where fast rise time is required and higher inrush current can be tolerated, consider using the TPS22925Bx. For an application that requires a longer rise time and lower inrush current, consider using the TPS22925Cx. Calculate the maximum acceptable slew rate using the design requirements and Equation 4.

$$\frac{dv}{dt} = \frac{I_{\text{INRUSH}}}{C_L} = \frac{40 \text{ mA}}{1.0 \mu\text{F}} = 40 \text{ V/ms} \quad (4)$$

The TPS22925Bx has a typical rise time of 97 μs at 3.6 V. This results in a slew rate of 29.7 V/ms which meets the above design requirements. The TPS22925Cx has a typical rise time of 810 μs at 3.6 V. This results in a slew rate of 3.6 V/ms which also meets the above design requirements. Base on inrush current requirement, either devices can be used.

9.2.3 Application Curve

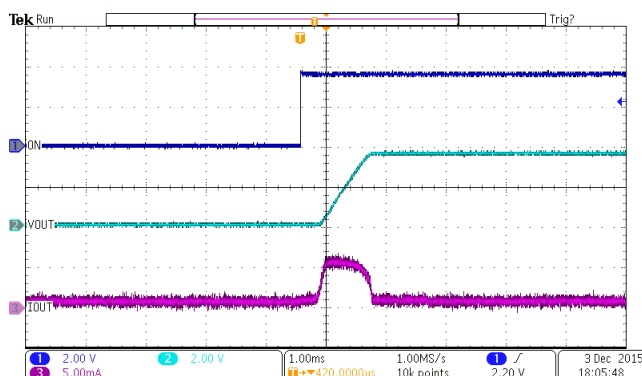

$$C_L = 1 \mu\text{F}$$

Figure 34. Inrush Current (TPS22925C)

10 Power Supply Recommendations

This family of devices is designed to operate with a V_{IN} range of 0.65 V to 3.6 V. This supply must be well regulated and placed as close to the device terminal as possible with the recommended 1 μF bypass capacitor. If the supply is located more than a few inches from the device terminals, additional bulk capacitance may be required in addition to the ceramic bypass capacitors. If additional bulk capacitance is required, an electrolytic, tantalum, or ceramic capacitor of 10 μF may be sufficient.

11 Layout

11.1 Layout Guidelines

For best performance, all traces must be as short as possible. To be most effective, the input and load capacitors must be placed close to the device to minimize the effects that parasitic trace inductances may have on operation. Using wide traces for VIN, VOUT, and GND helps minimize the parasitic electrical effects.

11.2 Layout Example

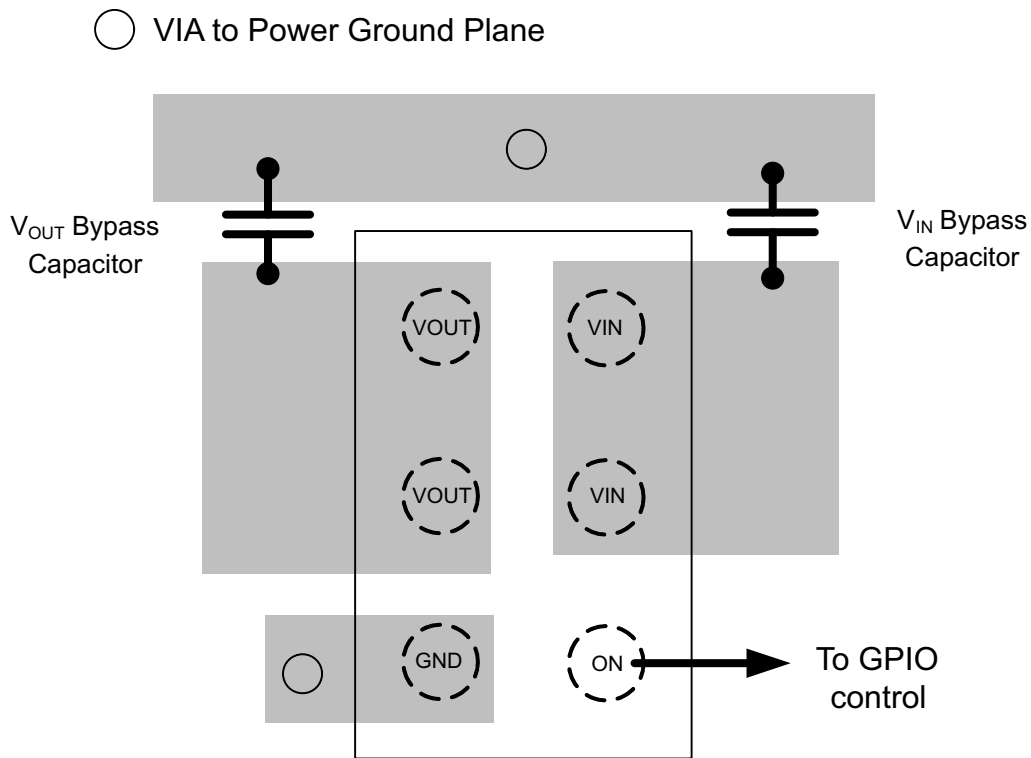

Figure 35. TPS22925xx Layout Example

12 Device and Documentation Support

12.1 Documentation Support

12.1.1 Related Documentation

For related documentation see the following:

- [Reverse Current Protection in Load Switches](#)
- [Quiescent Current vs Shutdown Current for Load Switch Power Consumption](#)
- [TPS22925EVM User's Guide](#)

12.2 Receiving Notification of Documentation Updates

To receive notification of documentation updates—including silicon errata—go to the product folder for your device on [ti.com](#). In the upper right-hand corner, click the *Alert me* button. This registers you to receive a weekly digest of product information

12.3 Community Resources

The following links connect to TI community resources. Linked contents are provided "AS IS" by the respective contributors. They do not constitute TI specifications and do not necessarily reflect TI's views; see TI's [Terms of Use](#).

TI E2E™ Online Community *TI's Engineer-to-Engineer (E2E) Community*. Created to foster collaboration among engineers. At [e2e.ti.com](#), you can ask questions, share knowledge, explore ideas and help solve problems with fellow engineers.

Design Support *TI's Design Support* Quickly find helpful E2E forums along with design support tools and contact information for technical support.

12.4 Trademarks

E2E is a trademark of Texas Instruments.

All other trademarks are the property of their respective owners.

12.5 Electrostatic Discharge Caution



This integrated circuit can be damaged by ESD. Texas Instruments recommends that all integrated circuits be handled with appropriate precautions. Failure to observe proper handling and installation procedures can cause damage.

ESD damage can range from subtle performance degradation to complete device failure. Precision integrated circuits may be more susceptible to damage because very small parametric changes could cause the device not to meet its published specifications.

12.6 Glossary

[SLYZ022](#) — *TI Glossary*.

This glossary lists and explains terms, acronyms, and definitions.

13 Mechanical, Packaging, and Orderable Information

The following pages include mechanical, packaging, and orderable information. This information is the most current data available for the designated devices. This data is subject to change without notice and revision of this document. For browser-based versions of this data sheet, refer to the left-hand navigation.

PACKAGING INFORMATION

Orderable Device	Status (1)	Package Type	Package Drawing	Pins	Package Qty	Eco Plan (2)	Lead finish/ Ball material (6)	MSL Peak Temp (3)	Op Temp (°C)	Device Marking (4/5)	Samples
TPS22925BNYPHR	ACTIVE	DSBGA	YPH	6	3000	RoHS & Green	SAC396 SNAGCU	Level-1-260C-UNLIM	-40 to 105	12D9	Samples
TPS22925BNYPHT	ACTIVE	DSBGA	YPH	6	250	RoHS & Green	SAC396 SNAGCU	Level-1-260C-UNLIM	-40 to 105	12D9	Samples
TPS22925BYPHR	ACTIVE	DSBGA	YPH	6	3000	RoHS & Green	SAC396 SNAGCU	Level-1-260C-UNLIM	-40 to 105	12A8	Samples
TPS22925BYPHT	ACTIVE	DSBGA	YPH	6	250	RoHS & Green	SAC396 SNAGCU	Level-1-260C-UNLIM	-40 to 105	12A8	Samples
TPS22925CNYPHR	ACTIVE	DSBGA	YPH	6	3000	RoHS & Green	SAC396 SNAGCU	Level-1-260C-UNLIM	-40 to 105	12C9	Samples
TPS22925CNPHT	ACTIVE	DSBGA	YPH	6	250	RoHS & Green	SAC396 SNAGCU	Level-1-260C-UNLIM	-40 to 105	12C9	Samples
TPS22925CYPHR	ACTIVE	DSBGA	YPH	6	3000	RoHS & Green	SAC396 SNAGCU	Level-1-260C-UNLIM	-40 to 105	12B9	Samples
TPS22925CYPHT	ACTIVE	DSBGA	YPH	6	250	RoHS & Green	SAC396 SNAGCU	Level-1-260C-UNLIM	-40 to 105	12B9	Samples

(1) The marketing status values are defined as follows:

ACTIVE: Product device recommended for new designs.

LIFEBUY: TI has announced that the device will be discontinued, and a lifetime-buy period is in effect.

NRND: Not recommended for new designs. Device is in production to support existing customers, but TI does not recommend using this part in a new design.

PREVIEW: Device has been announced but is not in production. Samples may or may not be available.

OBSOLETE: TI has discontinued the production of the device.

(2) **RoHS:** TI defines "RoHS" to mean semiconductor products that are compliant with the current EU RoHS requirements for all 10 RoHS substances, including the requirement that RoHS substance do not exceed 0.1% by weight in homogeneous materials. Where designed to be soldered at high temperatures, "RoHS" products are suitable for use in specified lead-free processes. TI may reference these types of products as "Pb-Free".

RoHS Exempt: TI defines "RoHS Exempt" to mean products that contain lead but are compliant with EU RoHS pursuant to a specific EU RoHS exemption.

Green: TI defines "Green" to mean the content of Chlorine (Cl) and Bromine (Br) based flame retardants meet JS709B low halogen requirements of <=1000ppm threshold. Antimony trioxide based flame retardants must also meet the <=1000ppm threshold requirement.

(3) MSL, Peak Temp. - The Moisture Sensitivity Level rating according to the JEDEC industry standard classifications, and peak solder temperature.

(4) There may be additional marking, which relates to the logo, the lot trace code information, or the environmental category on the device.

(5) Multiple Device Markings will be inside parentheses. Only one Device Marking contained in parentheses and separated by a "~" will appear on a device. If a line is indented then it is a continuation of the previous line and the two combined represent the entire Device Marking for that device.

⁽⁶⁾ Lead finish/Ball material - Orderable Devices may have multiple material finish options. Finish options are separated by a vertical ruled line. Lead finish/Ball material values may wrap to two lines if the finish value exceeds the maximum column width.

Important Information and Disclaimer: The information provided on this page represents TI's knowledge and belief as of the date that it is provided. TI bases its knowledge and belief on information provided by third parties, and makes no representation or warranty as to the accuracy of such information. Efforts are underway to better integrate information from third parties. TI has taken and continues to take reasonable steps to provide representative and accurate information but may not have conducted destructive testing or chemical analysis on incoming materials and chemicals. TI and TI suppliers consider certain information to be proprietary, and thus CAS numbers and other limited information may not be available for release.

In no event shall TI's liability arising out of such information exceed the total purchase price of the TI part(s) at issue in this document sold by TI to Customer on an annual basis.

TAPE AND REEL INFORMATION

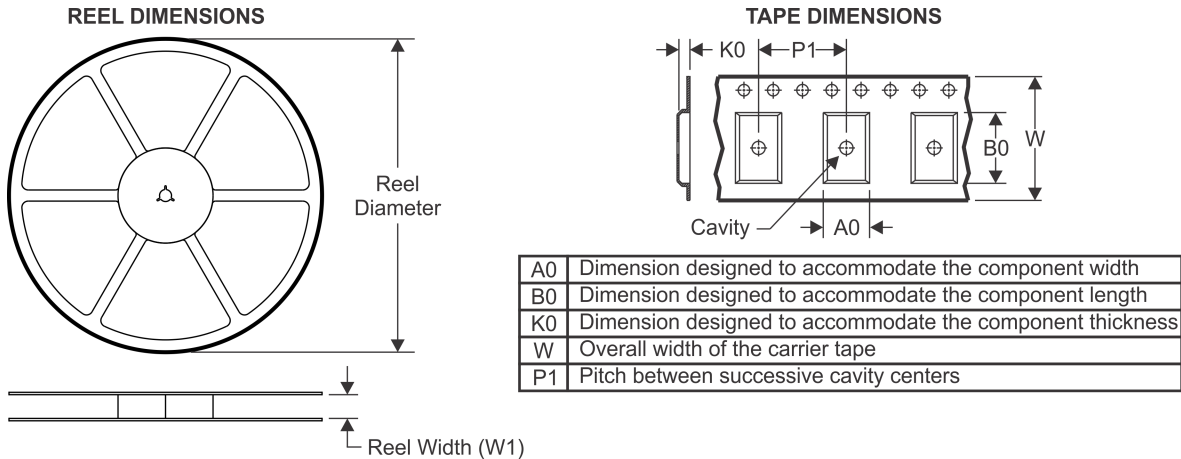

QUADRANT ASSIGNMENTS FOR PIN 1 ORIENTATION IN TAPE

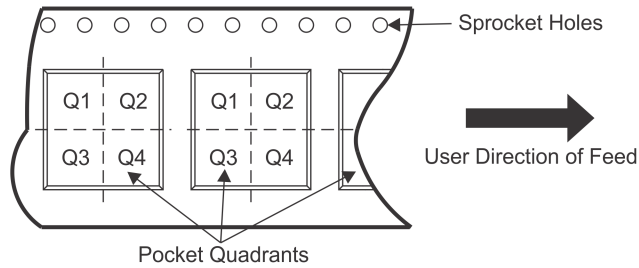

*All dimensions are nominal

Device	Package Type	Package Drawing	Pins	SPQ	Reel Diameter (mm)	Reel Width W1 (mm)	A0 (mm)	B0 (mm)	K0 (mm)	P1 (mm)	W (mm)	Pin1 Quadrant
TPS22925BNYPHR	DSBGA	YPH	6	3000	180.0	8.4	0.96	1.46	0.42	4.0	8.0	Q1
TPS22925BNYPHR	DSBGA	YPH	6	3000	178.0	9.2	1.02	1.52	0.5	4.0	8.0	Q1
TPS22925BNYPHT	DSBGA	YPH	6	250	178.0	9.2	1.02	1.52	0.5	4.0	8.0	Q1
TPS22925BNYPHT	DSBGA	YPH	6	250	180.0	8.4	0.96	1.46	0.42	4.0	8.0	Q1
TPS22925BYPHR	DSBGA	YPH	6	3000	178.0	9.2	1.02	1.52	0.5	4.0	8.0	Q1
TPS22925BYPHR	DSBGA	YPH	6	3000	180.0	8.4	0.96	1.46	0.42	4.0	8.0	Q1
TPS22925BYPHT	DSBGA	YPH	6	250	180.0	8.4	0.96	1.46	0.42	4.0	8.0	Q1
TPS22925BYPHT	DSBGA	YPH	6	250	178.0	9.2	1.02	1.52	0.5	4.0	8.0	Q1
TPS22925CNYPHR	DSBGA	YPH	6	3000	180.0	8.4	0.96	1.46	0.42	4.0	8.0	Q1
TPS22925CNYPHT	DSBGA	YPH	6	250	180.0	8.4	0.96	1.46	0.42	4.0	8.0	Q1
TPS22925CYPHR	DSBGA	YPH	6	3000	178.0	9.2	1.02	1.52	0.5	4.0	8.0	Q1
TPS22925CYPHR	DSBGA	YPH	6	3000	180.0	8.4	0.96	1.46	0.42	4.0	8.0	Q1
TPS22925CYPHT	DSBGA	YPH	6	250	180.0	8.4	0.96	1.46	0.42	4.0	8.0	Q1
TPS22925CYPHT	DSBGA	YPH	6	250	178.0	9.2	1.02	1.52	0.5	4.0	8.0	Q1

PACKAGE MATERIALS INFORMATION

8-Jun-2021

TAPE AND REEL BOX DIMENSIONS

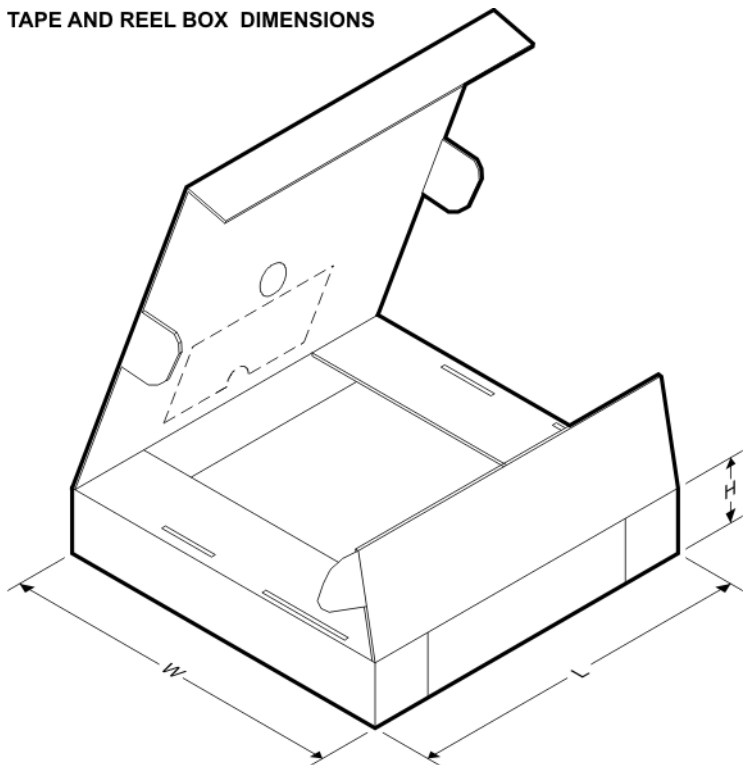

*All dimensions are nominal

Device	Package Type	Package Drawing	Pins	SPQ	Length (mm)	Width (mm)	Height (mm)
TPS22925BNYPHR	DSBGA	YPH	6	3000	182.0	182.0	20.0
TPS22925BNYPHR	DSBGA	YPH	6	3000	220.0	220.0	35.0
TPS22925BNYPHT	DSBGA	YPH	6	250	220.0	220.0	35.0
TPS22925BNYPHT	DSBGA	YPH	6	250	182.0	182.0	20.0
TPS22925BYPHR	DSBGA	YPH	6	3000	220.0	220.0	35.0
TPS22925BYPHR	DSBGA	YPH	6	3000	182.0	182.0	20.0
TPS22925BYPHT	DSBGA	YPH	6	250	182.0	182.0	20.0
TPS22925BYPHT	DSBGA	YPH	6	250	220.0	220.0	35.0
TPS22925CNYPHR	DSBGA	YPH	6	3000	182.0	182.0	20.0
TPS22925CNYPHT	DSBGA	YPH	6	250	182.0	182.0	20.0
TPS22925CYPHR	DSBGA	YPH	6	3000	220.0	220.0	35.0
TPS22925CYPHR	DSBGA	YPH	6	3000	182.0	182.0	20.0
TPS22925CYPHT	DSBGA	YPH	6	250	182.0	182.0	20.0
TPS22925CYPHT	DSBGA	YPH	6	250	220.0	220.0	35.0

YPH0006

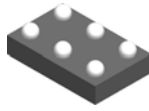

PACKAGE OUTLINE

DSBGA - 0.4 mm max height

DIE SIZE BALL GRID ARRAY

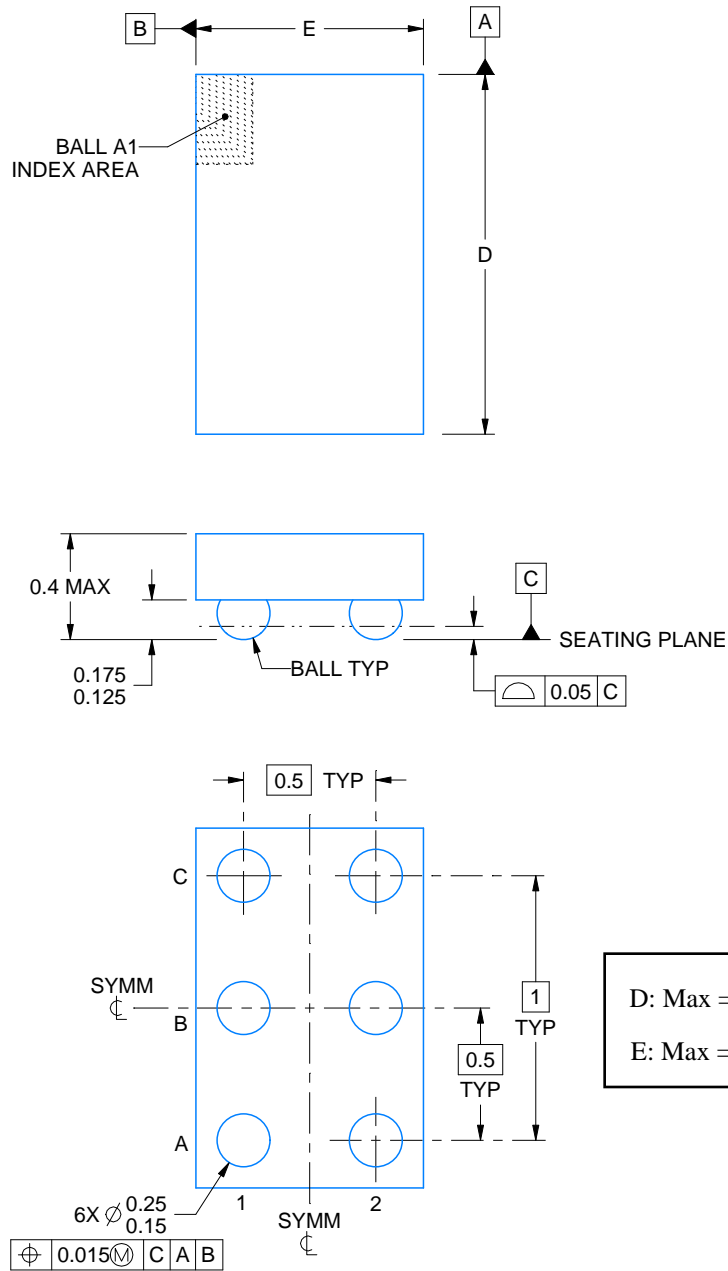

4223801/A 06/2017

NOTES:

NanoFree is a trademark of Texas Instruments.

1. All linear dimensions are in millimeters. Any dimensions in parenthesis are for reference only. Dimensioning and tolerancing per ASME Y14.5M.
2. This drawing is subject to change without notice.
3. NanoFree™ package configuration.

EXAMPLE BOARD LAYOUT

YPH0006

DSBGA - 0.4 mm max height

DIE SIZE BALL GRID ARRAY

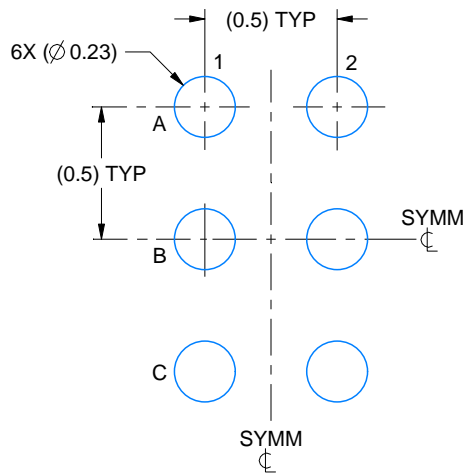

LAND PATTERN EXAMPLE
EXPOSED METAL SHOWN
SCALE:35X

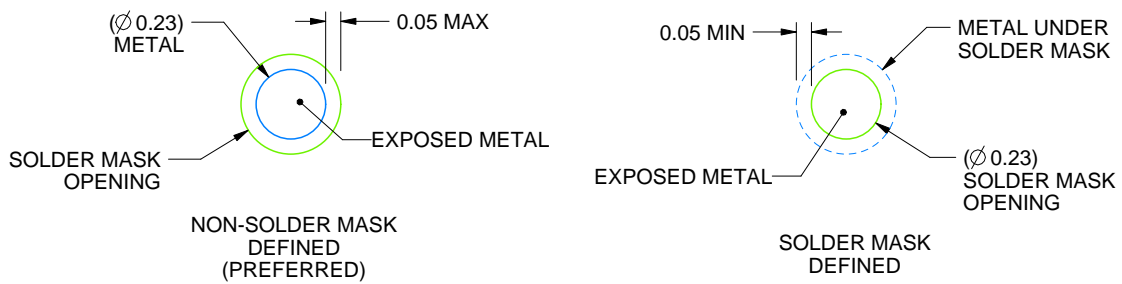

SOLDER MASK DETAILS
NOT TO SCALE

4223801/A 06/2017

NOTES: (continued)

- Final dimensions may vary due to manufacturing tolerance considerations and also routing constraints. For more information, see Texas Instruments literature number SNVA009 (www.ti.com/lit/snva009).

EXAMPLE STENCIL DESIGN

YPH0006

DSBGA - 0.4 mm max height

DIE SIZE BALL GRID ARRAY

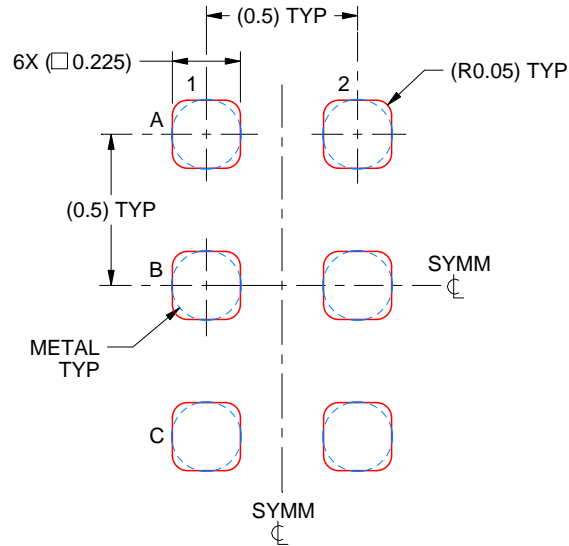

SOLDER PASTE EXAMPLE
BASED ON 0.1 mm THICK STENCIL
SCALE:40X

4223801/A 06/2017

NOTES: (continued)

5. Laser cutting apertures with trapezoidal walls and rounded corners may offer better paste release.

IMPORTANT NOTICE AND DISCLAIMER

TI PROVIDES TECHNICAL AND RELIABILITY DATA (INCLUDING DATA SHEETS), DESIGN RESOURCES (INCLUDING REFERENCE DESIGNS), APPLICATION OR OTHER DESIGN ADVICE, WEB TOOLS, SAFETY INFORMATION, AND OTHER RESOURCES "AS IS" AND WITH ALL FAULTS, AND DISCLAIMS ALL WARRANTIES, EXPRESS AND IMPLIED, INCLUDING WITHOUT LIMITATION ANY IMPLIED WARRANTIES OF MERCHANTABILITY, FITNESS FOR A PARTICULAR PURPOSE OR NON-INFRINGEMENT OF THIRD PARTY INTELLECTUAL PROPERTY RIGHTS.

These resources are intended for skilled developers designing with TI products. You are solely responsible for (1) selecting the appropriate TI products for your application, (2) designing, validating and testing your application, and (3) ensuring your application meets applicable standards, and any other safety, security, regulatory or other requirements.

These resources are subject to change without notice. TI grants you permission to use these resources only for development of an application that uses the TI products described in the resource. Other reproduction and display of these resources is prohibited. No license is granted to any other TI intellectual property right or to any third party intellectual property right. TI disclaims responsibility for, and you will fully indemnify TI and its representatives against, any claims, damages, costs, losses, and liabilities arising out of your use of these resources.

TI's products are provided subject to [TI's Terms of Sale](#) or other applicable terms available either on [ti.com](https://www.ti.com) or provided in conjunction with such TI products. TI's provision of these resources does not expand or otherwise alter TI's applicable warranties or warranty disclaimers for TI products.

TI objects to and rejects any additional or different terms you may have proposed.

Mailing Address: Texas Instruments, Post Office Box 655303, Dallas, Texas 75265
Copyright © 2023, Texas Instruments Incorporated