

GENERAL DESCRIPTION

The SGM66055A is an internally compensated, 2.2MHz switching frequency, current mode, synchronous step-up switching regulator. Even below the minimum system battery voltage, the device maintains the output voltage regulation for a minimum output load current of 0.7A. This device turns into power-save mode to maintain high efficiency by lowering switching frequency. With its anti-ringing circuitry damping the charge in parasitic capacitor, it reduces EMI interference significantly.

In addition, the SGM66055A device can also support the pass-through mode by pulling EN to low. In this mode, the output voltage follows the input voltage with a voltage drop by the resistance of the inductor and high-side FET.

The SGM66055A-5.0 and SGM66055A-5.4 are preset for outputting 5.0V and 5.4V.

The device is available in a Green WLCSP-1.21×1.21-9B package and operates over an ambient temperature range of -40°C to +85°C.

FEATURES

- **93% Efficient Synchronous Boost Converter**
- **Device Quiescent Current: 23μA (TYP)**
- **Operating Input Voltage Range: 2.5V to 4.5V**
- **Fixed Output Voltages: 5.0V and 5.4V**
- **Output Voltage Clamping: 5.7V**
- **Power-Save Mode for Improved Efficiency at Low Output Power**
- **Pass-through Mode by Pulling EN Low**
- **Low Reverse Leakage Current when $V_{OUT} > V_{IN}$**
- **Over-Temperature Protection**
- **Available in a Green WLCSP-1.21×1.21-9B Package**
- **-40°C to +85°C Operating Temperature Range**

APPLICATIONS

Class-D Audio Amplifier and USB OTG Supply
 Boost for Low-Voltage Li-Ion Batteries
 Smart Phones, Tablets, Portable Devices, Wearables

TYPICAL APPLICATION

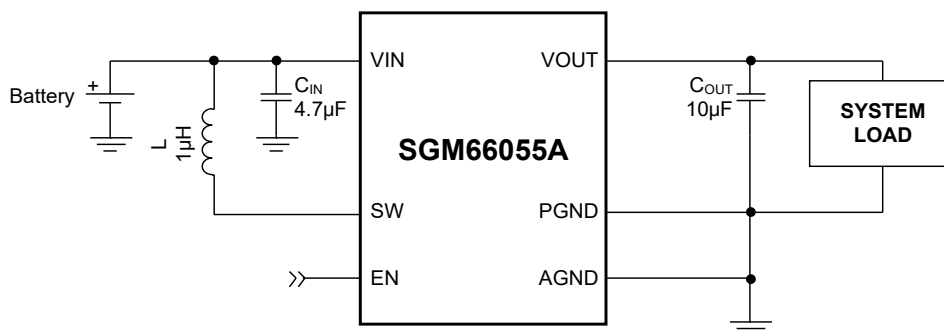

Figure 1. Typical Application Circuit

PACKAGE/ORDERING INFORMATION

MODEL	V _{OUT} (V)	PACKAGE DESCRIPTION	SPECIFIED TEMPERATURE RANGE	ORDERING NUMBER	PACKAGE MARKING	PACKING OPTION
SGM66055A	5.0	WLCSP-1.21×1.21-9B	-40°C to +85°C	SGM66055A-5.0YG/TR	GP2 XXXX	Tape and Reel, 3000
	5.4	WLCSP-1.21×1.21-9B	-40°C to +85°C	SGM66055A-5.4YG/TR	GP3 XXXX	Tape and Reel, 3000

MARKING INFORMATION

NOTE: XXXX = Date Code.

YYY — Serial Number

XXXX

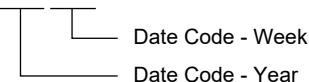

Green (RoHS & HSF): SG Micro Corp defines "Green" to mean Pb-Free (RoHS compatible) and free of halogen substances. If you have additional comments or questions, please contact your SGMICRO representative directly.

ABSOLUTE MAXIMUM RATINGS

- Voltage on VIN Pin -0.3V to 5.5V
- Voltage on VOUT Pin 6V
- SW Node (DC)..... -0.3V to 6V
- SW Node (Transient: 10ns, 3MHz)..... -1V to 8V
- Voltage on Other Pins.....-0.3V to 6V⁽¹⁾
- Package Thermal Resistance
- WLCSP-1.21×1.21-9B, θ_{JA}.90°C/W
- Junction Temperature.....+150°C
- Storage Temperature Range-65°C to +150°C
- Lead Temperature (Soldering, 10s).....+260°C
- ESD Susceptibility
- HBM..... 4000V
- MM.....400V
- CDM 1000V

NOTE: 1. Lesser of 6V or V_{IN} + 0.3V.

OVERSTRESS CAUTION

Stresses beyond those listed in Absolute Maximum Ratings may cause permanent damage to the device. Exposure to absolute maximum rating conditions for extended periods may affect reliability. Functional operation of the device at any conditions beyond those indicated in the Recommended Operating Conditions section is not implied.

ESD SENSITIVITY CAUTION

This integrated circuit can be damaged by ESD if you don't pay attention to ESD protection. SGMICRO recommends that all integrated circuits be handled with appropriate precautions. Failure to observe proper handling and installation procedures can cause damage. ESD damage can range from subtle performance degradation to complete device failure. Precision integrated circuits may be more susceptible to damage because very small parametric changes could cause the device not to meet its published specifications.

DISCLAIMER

SG Micro Corp reserves the right to make any change in circuit design, or specifications without prior notice.

PIN CONFIGURATION

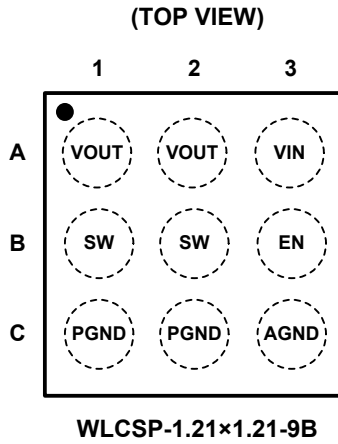

PIN DESCRIPTION

PIN	NAME	FUNCTION
A1, A2	VOUT	Output Voltage. This pin is the output voltage terminal; connect directly to C _{OUT} .
A3	VIN	Input Voltage. Connect to Li-Ion battery input power source and the bias supply for the gate drivers.
B1, B2	SW	Switching Node. Connect to inductor.
B3	EN	EN = HIGH, the device works in the boost mode; EN = LOW, the device is in pass-through mode. In pass-through operation, current limit function is not enabled.
C1, C2	PGND	Power Ground. This is the power return for the IC. C _{OUT} capacitor should be returned with the shortest path possible to these pins.
C3	AGND	Analog Ground. This is the signal ground reference for the IC. All voltage levels are measured with respect to this pin – connect to PGND at a single point.

ELECTRICAL CHARACTERISTICS(V_{IN} = 3.6V, Full = -40°C to +85°C, typical values are at T_A = +25°C, unless otherwise noted.)

PARAMETER	SYMBOL	CONDITIONS	TEMP	MIN	TYP	MAX	UNITS
DC/DC STAGE							
Input Voltage Range	V _{IN}		+25°C	2.5		4.5	V
Switching Frequency	f		Full	1.80	2.20	2.55	MHz
Switch Current Limit	I _L	SGM66055A-5.0	+25°C	2.2	3.0	3.5	A
		SGM66055A-5.4	+25°C	0.9	1.3	1.7	
Boost Switch On-Resistance		V _{OUT} = 5.0V	+25°C		50	65	mΩ
Rectifying Switch On-Resistance		V _{OUT} = 5.0V	+25°C		60	80	mΩ
Output Voltage		SGM66055A-5.0	Full	4.89	5.00	5.15	V
		SGM66055A-5.4	Full	5.25	5.40	5.48	
Line Regulation		V _{IN} = 2.5V to V _{OUT} - 0.5V	+25°C		0.1		%
Load Regulation			+25°C		0.2		%
Quiescent Current	I _Q	V _{EN} = V _{IN} = 3.6V, not switching	+25°C		23	33	μA
Shutdown Current		V _{EN} = 0V, V _{IN} = 3.6V	+25°C			2.5	μA
CONTROL STAGE							
EN Input Low Voltage	V _{IL}		Full			0.4	V
EN Input High Voltage	V _{IH}		Full	1.3			V
EN Input Current		Clamped on GND or VIN	Full	-1		1	μA
Over-Temperature Protection					150		°C
Over-Temperature Hysteresis					20		°C

TYPICAL PERFORMANCE CHARACTERISTICS

T_A = +25°C, V_{IN} = 3.6V, C_{IN} = 4.7µF, C_{OUT} = 20µF, unless otherwise noted.

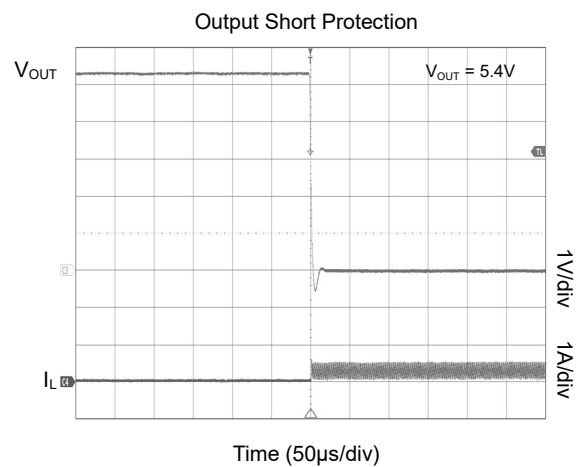
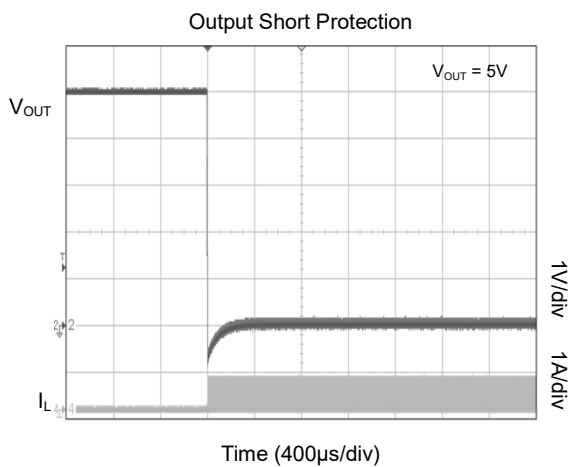
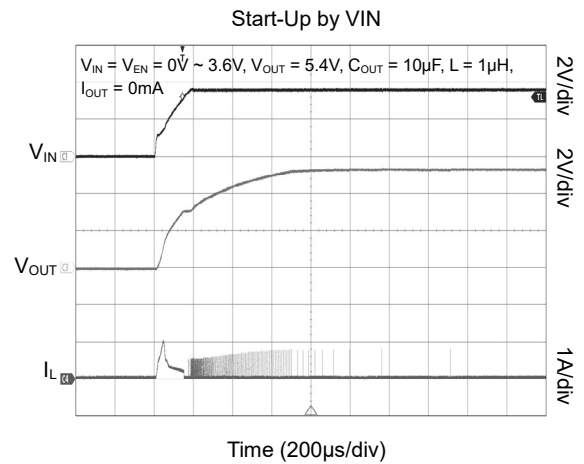
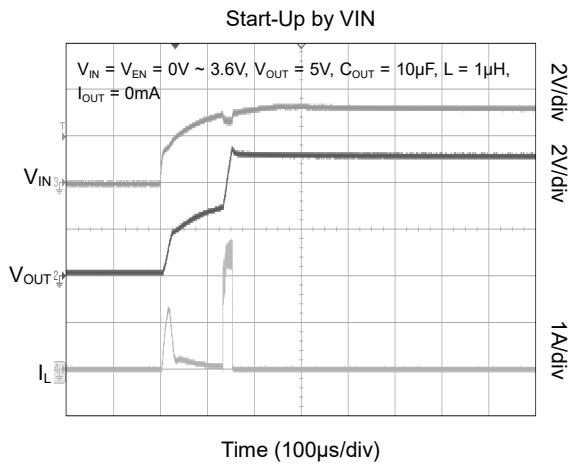
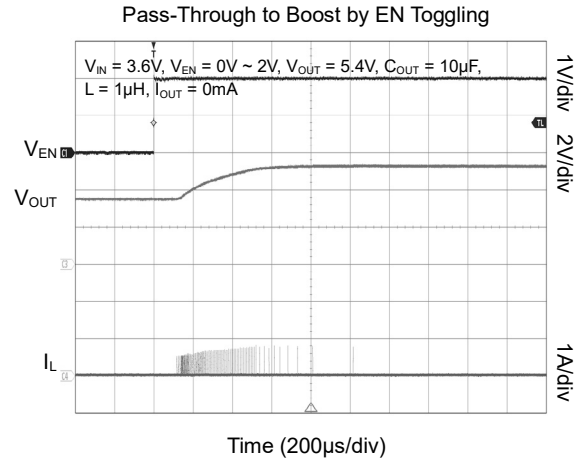
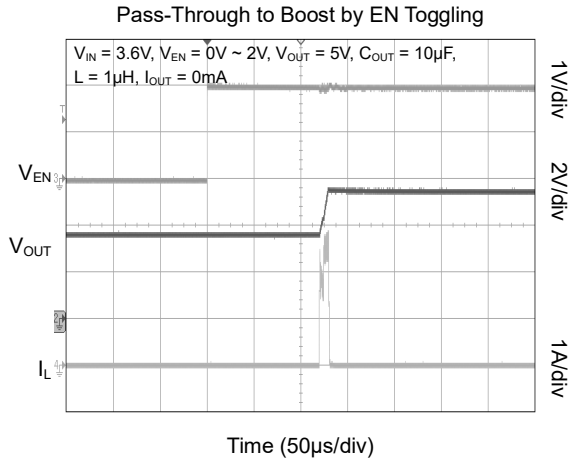

TYPICAL PERFORMANCE CHARACTERISTICS (continued)

T_A = +25°C, V_{IN} = 3.6V, C_{IN} = 4.7µF, C_{OUT} = 20µF, unless otherwise noted.

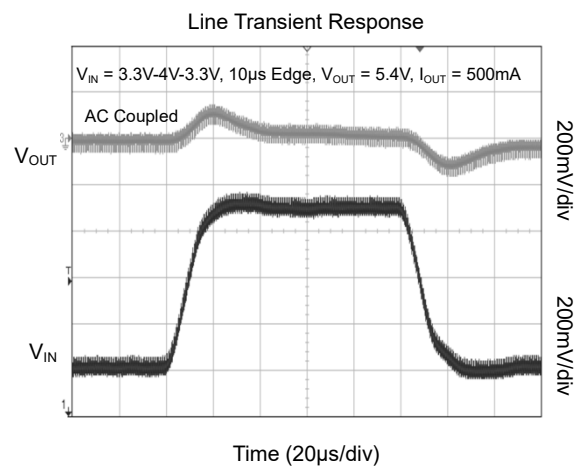
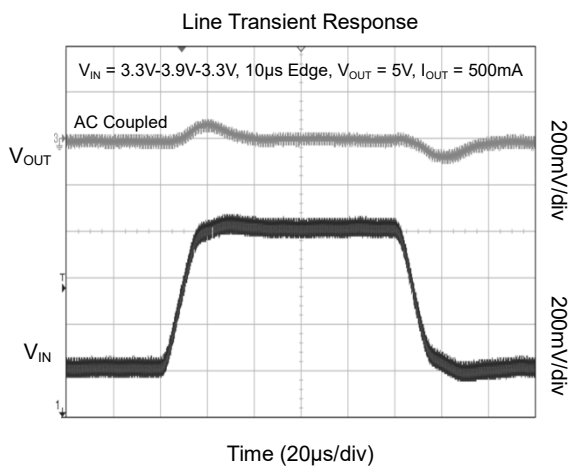
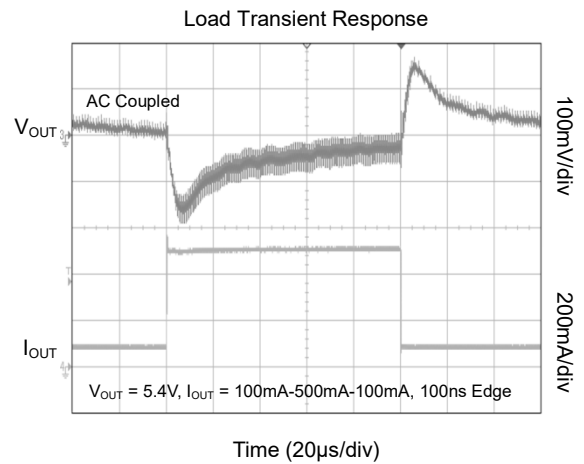
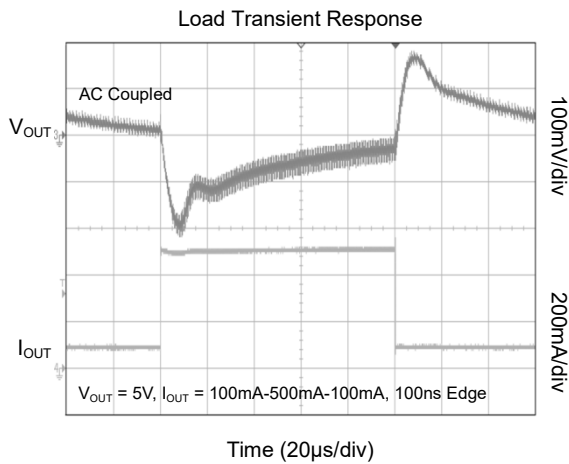
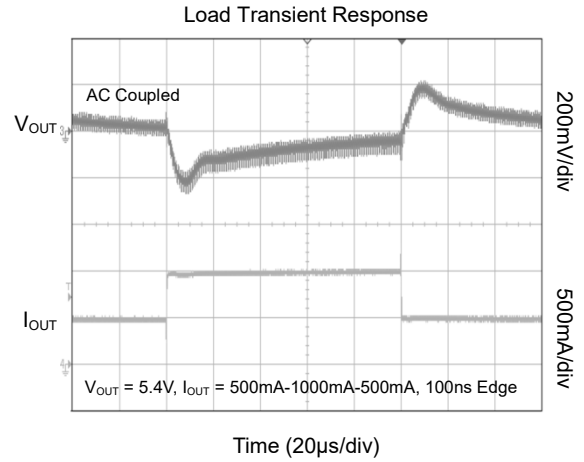
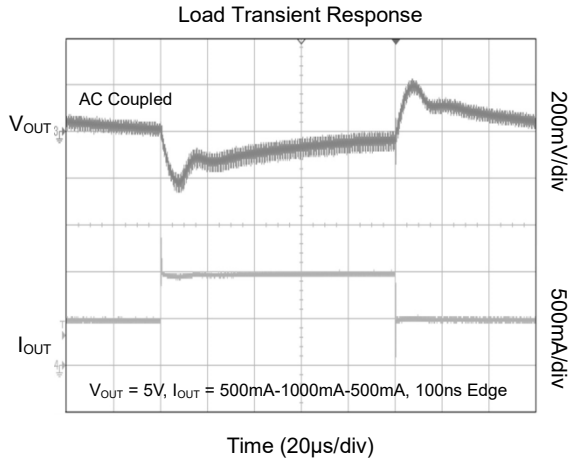

TYPICAL PERFORMANCE CHARACTERISTICS (continued)

$T_A = +25^\circ\text{C}$, $V_{IN} = 3.6\text{V}$, $C_{IN} = 4.7\mu\text{F}$, $C_{OUT} = 20\mu\text{F}$, unless otherwise noted.

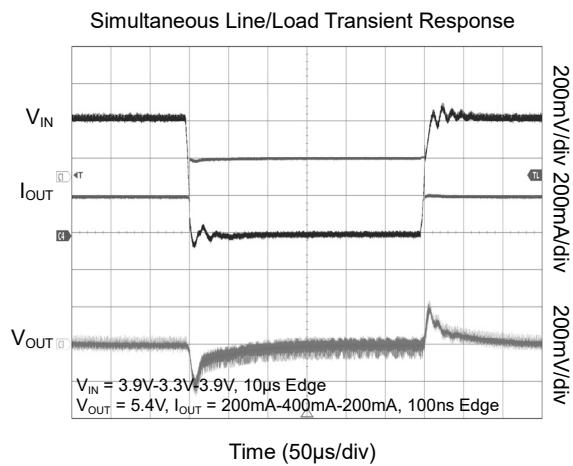
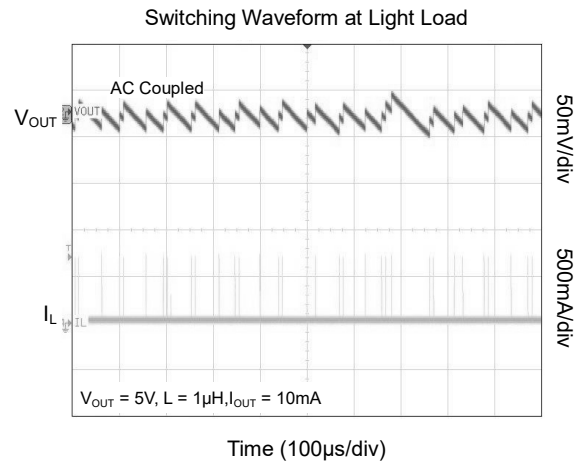
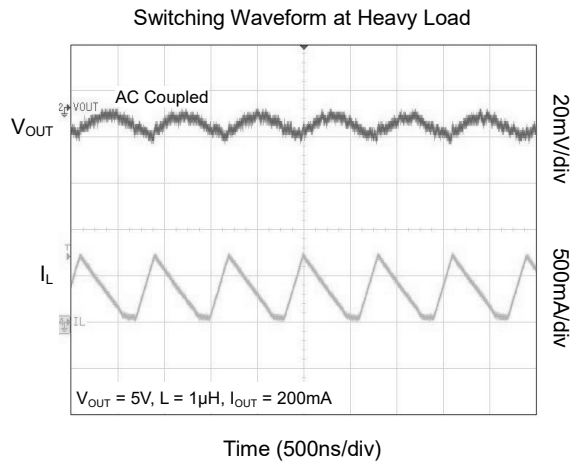

TYPICAL PERFORMANCE CHARACTERISTICS (continued)

T_A = +25°C, V_{IN} = 3.6V, C_{IN} = 4.7µF, C_{OUT} = 20µF, unless otherwise noted.

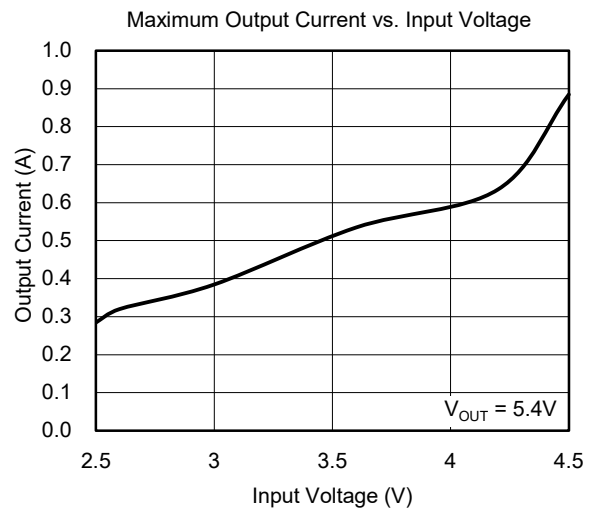
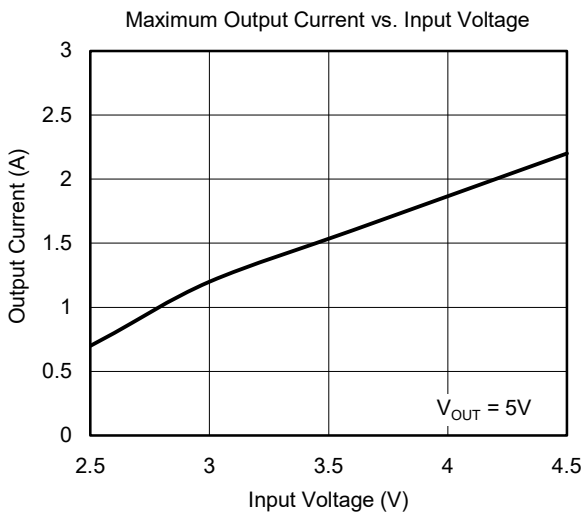
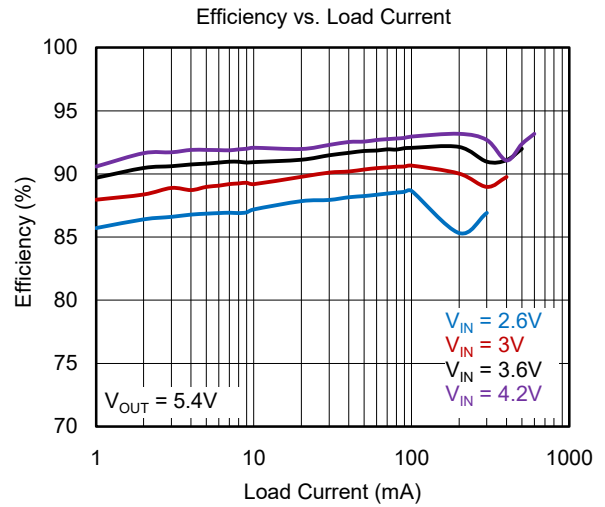
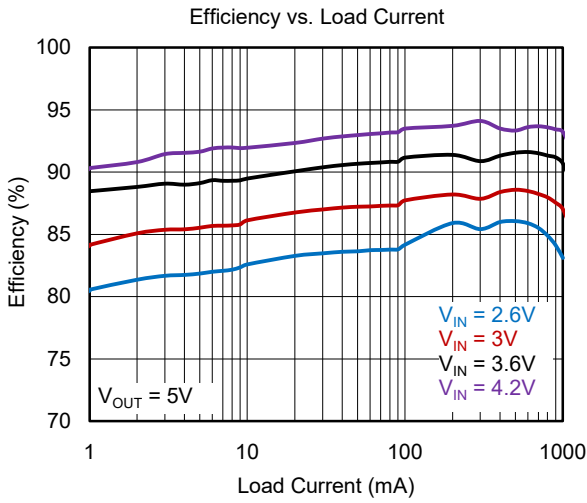

FUNCTIONAL BLOCK DIAGRAM

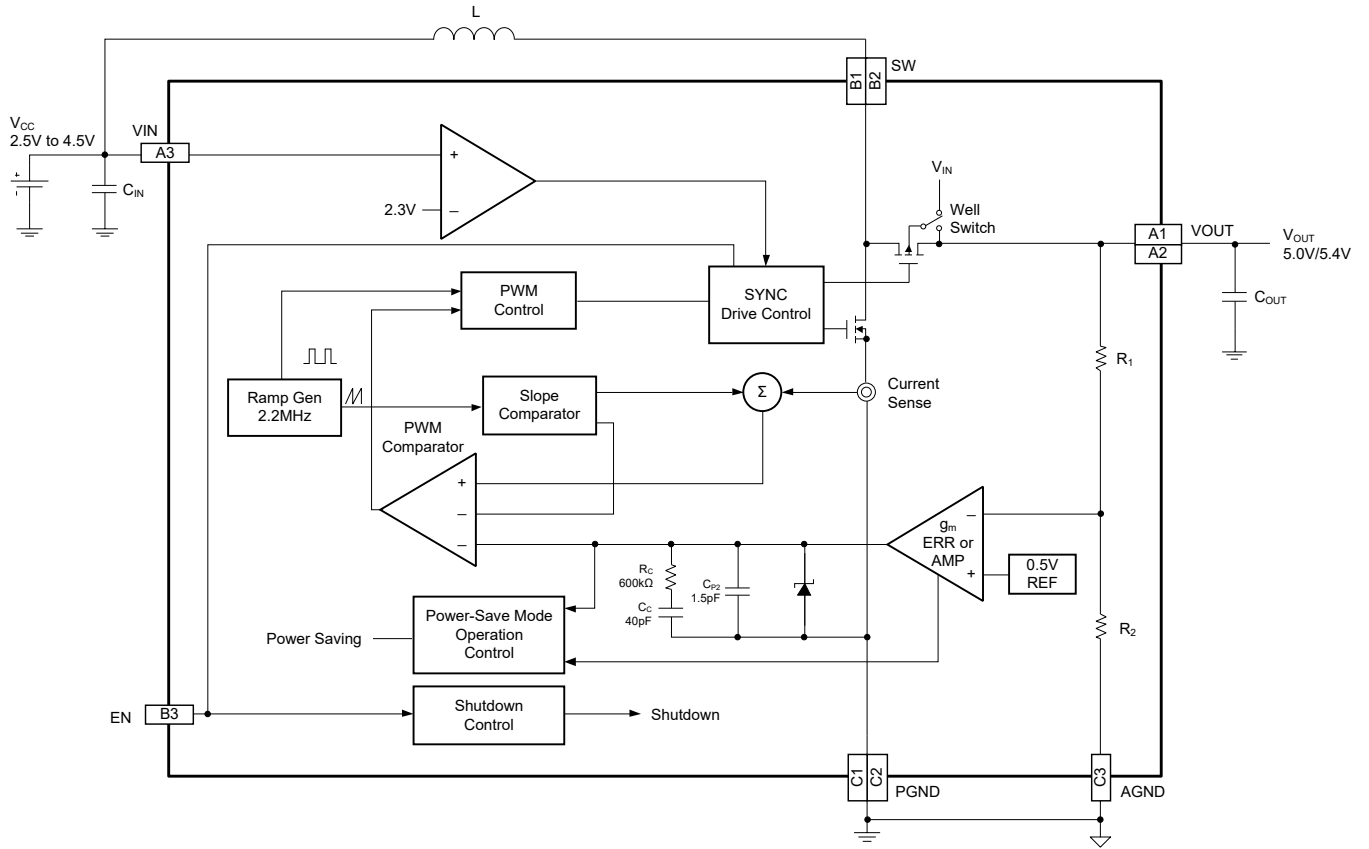

Figure 2. Block Diagram

APPLICATION INFORMATION

The SGM66055A is a boost DC/DC converter operating in 2.5V to 4.5V supply range, for generating a regulated output voltage which can be set to as low as 10% above the supply voltage. An inductor, an output storage capacitor and an input decoupling capacitor should be selected to ensure proper performance desired in a specific application circuit.

Inductor Selection

The device has been optimized to operate with inductance values between 0.47μH and 2.2μH. Nevertheless, operation with higher inductance values may be possible. Both average current and peak current should be evaluated in inductor selection. The maximum average inductor current is estimated using Equation 1:

$$I_L = I_{OUT} \times \frac{V_{OUT}}{V_{IN} \times 0.8} \quad (1)$$

For example, for an output current of 300mA at 5V, at least an average current of 700mA flows through the inductor at a minimum input voltage of 2.5V.

Choosing a proper inductance for a given current ripple value is readily done in design practice. A smaller ripple reduces the magnetic hysteresis losses in the inductor, as well as output voltage ripple and EMI. Though regulation settle time may rise when load changes. The minimum inductance value for the inductor at given condition is estimated by using Equation 2:

$$L = \frac{V_{IN} \times (V_{OUT} - V_{IN})}{\Delta I_L \times f \times V_{OUT}} \quad (2)$$

where f is the switching frequency and ΔI_L is the ripple current in the inductor, which normally is 20% of the average inductor current or is a design specified value. In typical applications, a 1μH inductance is recommended. If the load current is larger than 300mA, a 0.47μH inductance is recommended. After choosing an inductor, peak current at maximum loading and lowest input voltage is suggested to be evaluated, which should be lower than the switch current limit of this device as well as the inductor saturation current.

Input Capacitor

At least a 4.7μF input capacitor is recommended to improve transient behavior of the regulator and EMI behavior. A ceramic capacitor or a tantalum capacitor with a 100nF ceramic capacitor in parallel, placed close to the IC, is recommended.

Output Capacitor

The capacitance and the ESR define the output voltage ripple. Supposing that the ESR is zero, the minimum capacitance could be estimated by using Equation 3:

$$C_{MIN} = \frac{I_{OUT} \times (V_{OUT} - V_{IN})}{f \times \Delta V \times V_{OUT}} \quad (3)$$

where f is the switching frequency and ΔV is the maximum allowed voltage ripple.

The ESR and the additional ripple related to ESR may be negligible if a low ESR ceramic capacitor is used. This part of ESR component is calculated using Equation 4:

$$\Delta V_{ESR} = I_{OUT} \times R_{ESR} \quad (4)$$

The total ripple is the sum of the ripple caused by the capacitance and the ripple caused by the ESR of the capacitor. Additional voltage change may be caused by load transients; the output capacitor has to completely supply the load during the charging phase of the inductor.

The value of the output capacitance depends on the speed of the load transients and the load current during the load change. The recommended output capacitance value is in the range of 10μF to 47μF. If the load current is larger than 300mA, a minimum value of 22μF is recommended.

The capacitance loss due to the DC biasing and the high frequency performance has to be counted for de-rating. For example, larger form factor capacitors (in 1206 size) have their self-resonant frequencies in the same frequency range as the SGM66055A operating frequency. The effective capacitance of the capacitor may be significantly lower than its rating.

APPLICATION INFORMATION (continued)

Layout Considerations

Careful layout is always important to ensure good performance and stable operation to any kind of switching regulators. Place the capacitors close to the device, use the GND pin of the device as the center of star-connection to other grounds, and minimize the trace area of SW node. These measures reduce transient current loops and lower the possible parasitic ringing.

If a resistor divider is employed, the center tap to FB trace should have sufficient clearance from noisy PCB traces, as the FB node is sensitive and easily picks up noise.

Thermal Information

Implementation of integrated circuits in low-profile and fine-pitch surface-mount packages typically requires attention to power dissipation. Many system-dependent issues such as thermal coupling, airflow, added heat sinks and convection surfaces, and the presence of other heat-generating components affect the power dissipation limits of a given component.

Common approaches for enhancing thermal performance are listed below for convenient reference:

1. Improving the power dissipation capability of the PCB design.
2. Improving the thermal coupling of the component to the PCB.
3. Introducing airflow in the system.

REVISION HISTORY

NOTE: Page numbers for previous revisions may differ from page numbers in the current version.

MAY 2019 – REV.A.1 to REV.A.2		Page
Updated SGM66055A-5.4		4, 5, 7, 8
Updated Application Information		10
FEBRUARY 2019 – REV.A to REV.A.1		Page
Updated Features		1
Changes from Original (AUGUST 2018) to REV.A		Page
Changed from product preview to production data		All

PACKAGE OUTLINE DIMENSIONS

WLCSP-1.21×1.21-9B

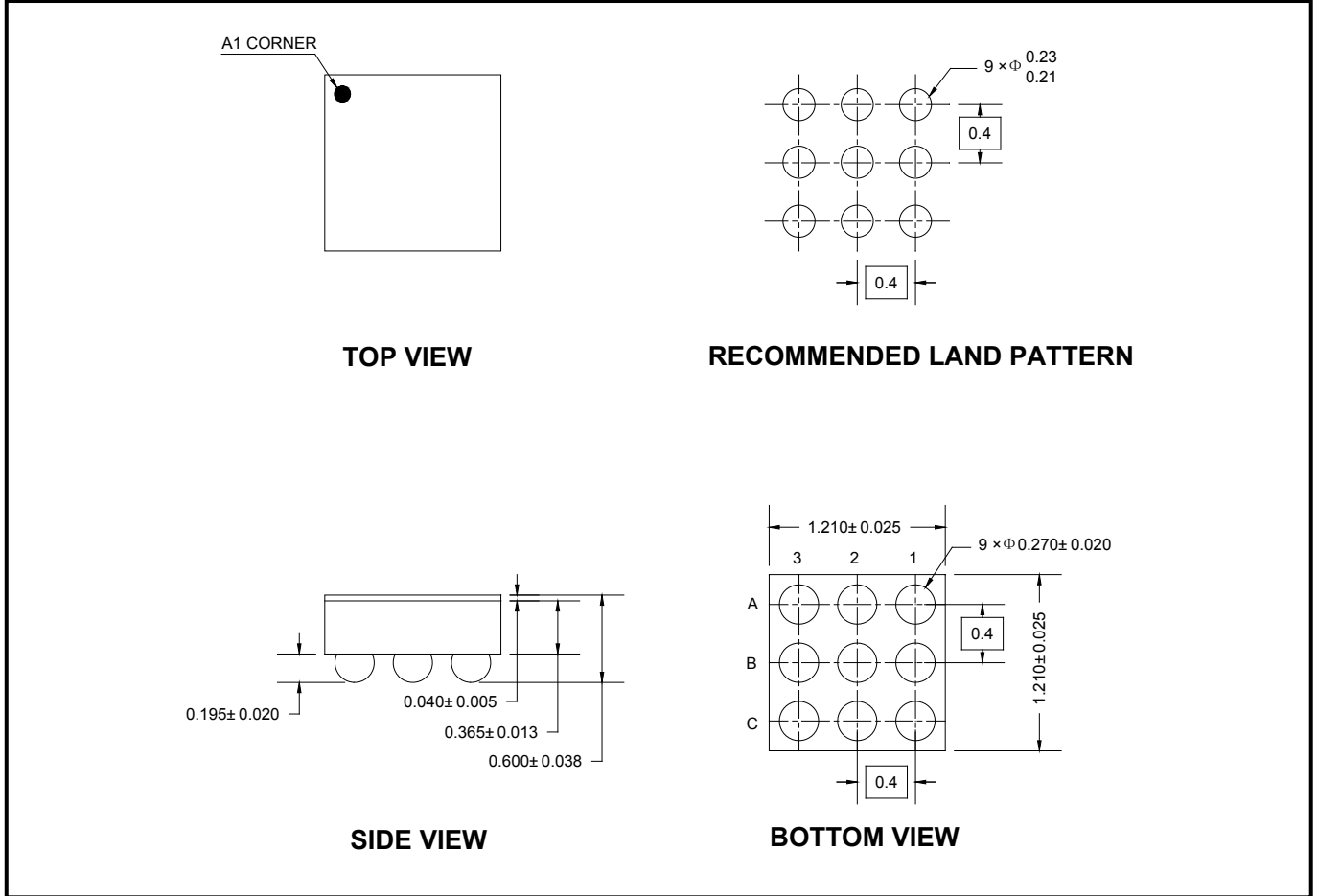

NOTE: All linear dimensions are in millimeters.

PACKAGE INFORMATION

TAPE AND REEL INFORMATION

REEL DIMENSIONS



TAPE DIMENSIONS



NOTE: The picture is only for reference. Please make the object as the standard.

KEY PARAMETER LIST OF TAPE AND REEL

Package Type	Reel Diameter	Reel Width W1 (mm)	A0 (mm)	B0 (mm)	K0 (mm)	P0 (mm)	P1 (mm)	P2 (mm)	W (mm)	Pin1 Quadrant
WLCSP-1.21×1.21-9B	7"	9.2	1.33	1.33	0.74	4.0	4.0	2.0	8.0	Q1

000001

PACKAGE INFORMATION

CARTON BOX DIMENSIONS



NOTE: The picture is only for reference. Please make the object as the standard.

KEY PARAMETER LIST OF CARTON BOX

Reel Type	Length (mm)	Width (mm)	Height (mm)	Pizza/Carton
7" (Option)	368	227	224	8
7"	442	410	224	18

DD0002